



1 Castelvechio Museum,
Verona: view through
painting galleries

A comparative analysis of the Sainsbury Wing of the National Gallery, London, and the Castelvecchio in Verona demonstrates that spatial structure is a powerful variable in museum experience.

Building and exhibition layout: Sainsbury Wing compared with Castelvecchio

Kali Tzortzi

Introduction

It has always been thought that there are two dimensions in museum experience: the experience of space which can be distinguished from that of exhibits, as the former is largely non-discursive while the latter is more in the discursive domain.¹ This paper aims to contribute to the description and understanding of the intricate pattern of interdependencies between the two parameters of the microstructure of the gallery space, the design of space and of the display layout. The paper uses rigorous methods of 'spatial data' collection and analysis (analytic representations of spatial relationships, and systematic representations of the movement pattern) and on this objective foundation builds an interpretative and critical argument. The approach progresses in stages, and looks at the ways the arrangement of objects relates to:

- a the spatial qualities of the museum's layout
- b the patterns of movement
- c the construction of the route, and by implication, the viewer's exploration of, and exposure to, information.

The questions proposed, tightly interwoven, are investigated in the context of the Castelvecchio Museum, Verona, and the Sainsbury Wing, the extension to the National Gallery, London. The latter, built by Venturi, Rauch and Scott Brown in 1986-1991, is specially and 'permanently designed for the early Renaissance collection of the National Gallery'.² The Castelvecchio is not a purpose-built museum, but a conversion of a historic building,³ redesigned in 1958-1974 by Carlo Scarpa, who was also responsible for the reorganisation of the spatial arrangement of the displays.⁴ Both constitute interesting cases, as the configurational properties of the layouts are closely connected to the organisation of the displays. Moreover, their collections, though they vary considerably in scale and importance, overlap chronologically. But what makes their study even more intriguing is the fact that the designs of the buildings and of the displays were developed together.⁵

Spatial properties of the layout

Let us begin by exploring the patterns of spatial organisation and the spatial qualities of the two contrasting layouts. Major axes are the recurrent theme of both. In particular, the powerful axiality is the key structural property of the layout of the Sainsbury Wing [2]. The whole structure is created by two intersecting major axes: a cross perspective axis, which is a continuation of the central axis of the main building, and penetrates the whole width of the extension; and another, vertical axis which crosses the central enfilade of rooms and runs across the whole length of the extension. Thus, the two axes provide information that reaches the periphery of the plan.

Similarly, on observing the entire complex of the Castelvecchio Museum, one finds an accentuated axial layout [3]; however, this becomes contradicted by a succession of oblique elements, inserted at the nodal points of the layout. Also, in contrast to the Sainsbury Wing, the axis of the entrance that crosses perpendicularly the long perspective axis of the



2 Gallery floor plan of the Sainsbury Wing showing locations of key paintings (in November 2002). Dotted lines indicate the main paths followed by visitors, observed during their visit through the galleries

2

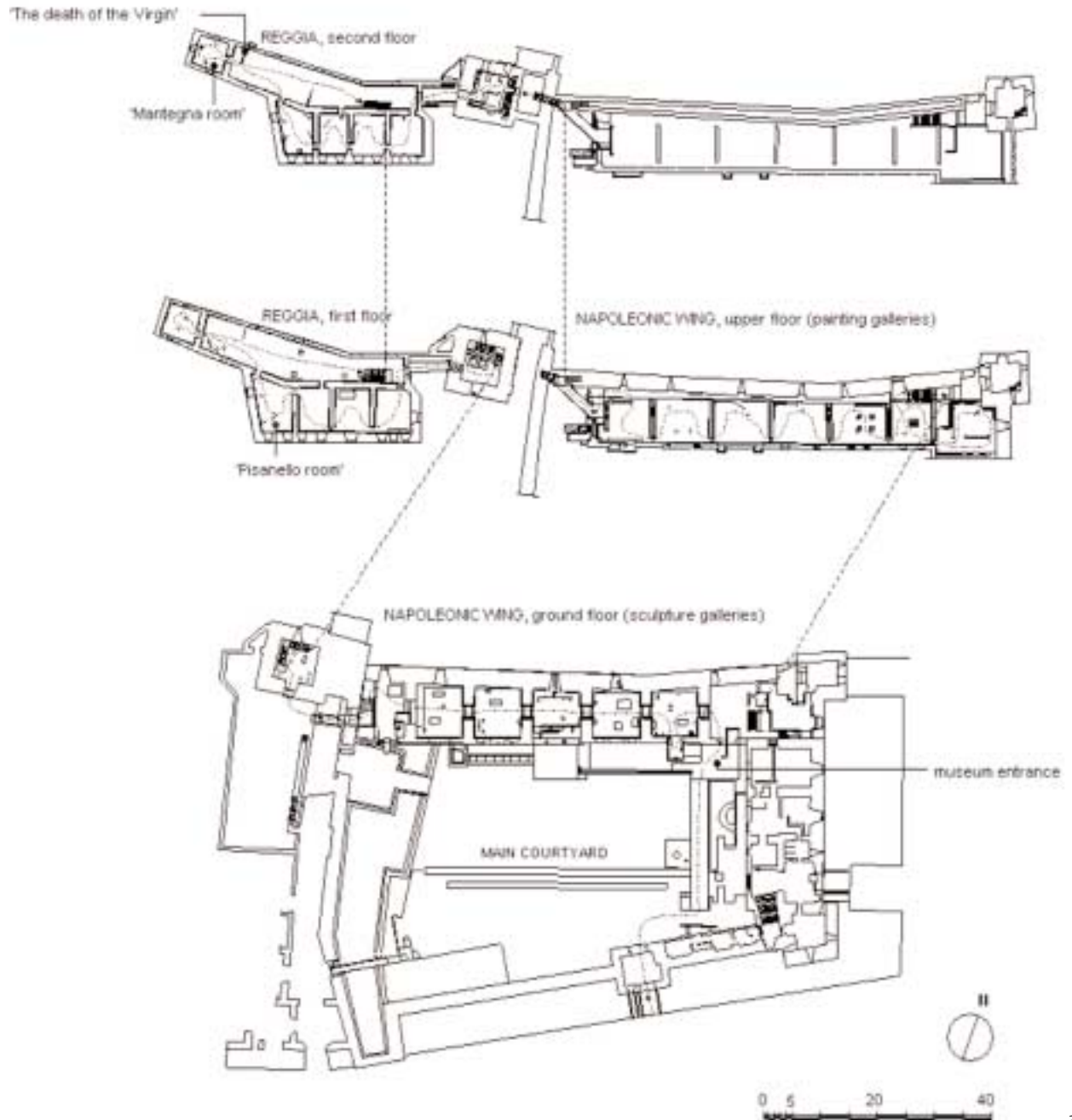

3

ground floor galleries, gives little guidance as to the overall structure of the layout.

Closely connected to the issue of axiality, perspective is used in very deliberate ways in the Sainsbury Wing. It may also imply the Renaissance preoccupation with what it means to design a building around perspectival ideas. The cross-axis which links the two buildings creates a false perspective and a visual play with the perspective construction of the painting placed at the end of the vista, Cima's *Incredulity of Saint Thomas*. This diminishing perspective seems to continue in the painting of the coffered ceiling [4a]. The central enfilade also makes use of the perspective [4b]. The arched openings emphasise its importance, and its long vista is terminated at each end by an altarpiece:

Raphael's *The Crucified Christ* on the north end wall, and Pollaiuolo's *The Martyrdom of San Sebastian* on the south.

At Castelvecchio, Scarpa also handles different kinds of perspective within the same spatial domain, the painting galleries [4c, d]. He deliberately closed the central doorways of the original transverse walls and designed two narrow circulation spaces: the north axis which runs from the outside and alongside the curved wall of the building, by the river, and creates a false perspective; and the south axis, on the side of the courtyard, which crosses the galleries and provides a diminishing perspective. Interestingly, both long perspective vistas are at one end, stopped by a blank wall, and at the other, anchored by an outside space.

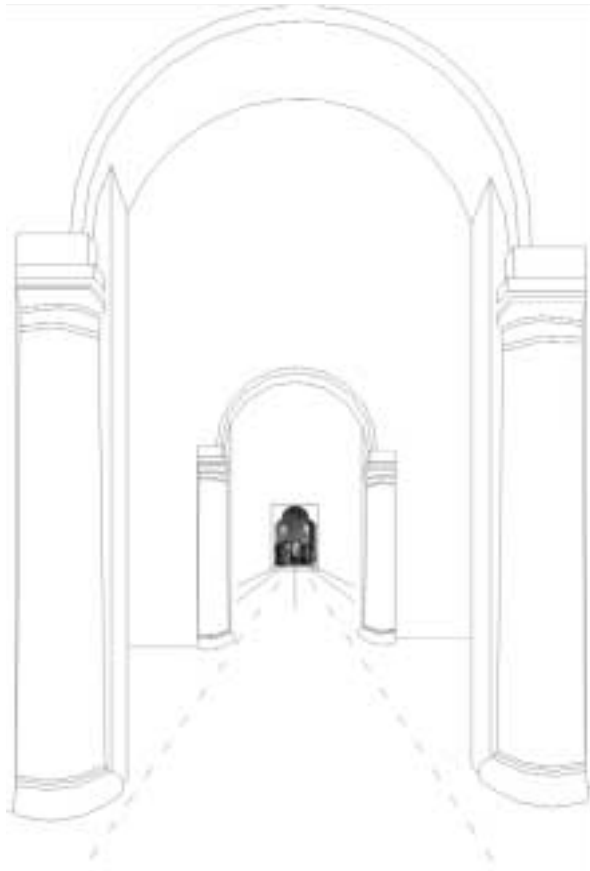

4a



4b



4c



4d

3 Overall plan of Castelvecchio showing locations of wings and key paintings (in February 2003). Broken lines show staircase links between floors. Dotted lines indicate the main paths followed by visitors,

observed during their visit through the galleries

4 *Sainsbury Wing*
a Perspective vista along the cross axis, and visual play with the perspective construction of Cima's painting
b Perspective view

through the central enfilade of rooms *Castelvecchio Museum*
Perspective view along the north axis of movement in the painting galleries, stopped by a blank wall at one end, c, and anchored by an outside space at the other, d

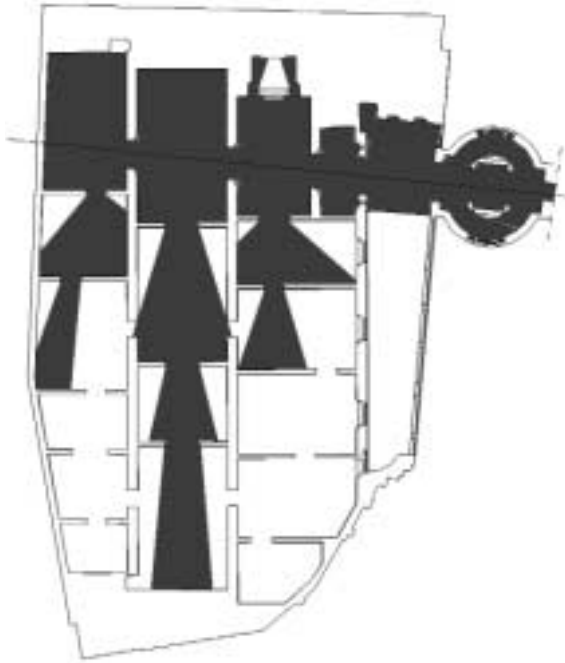

5a

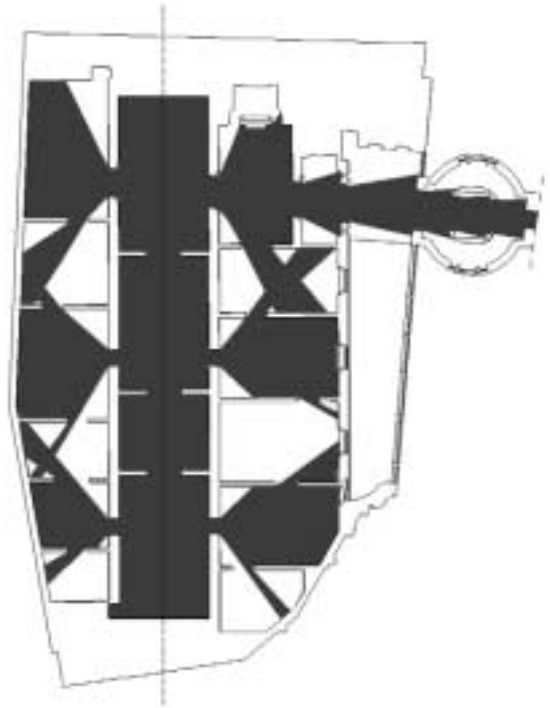

5b

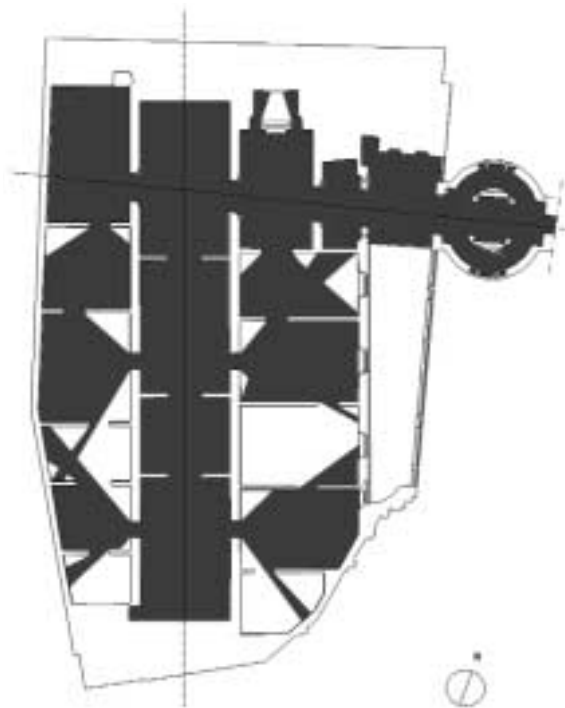

5c

Despite their similarities, a powerful difference between the two layouts is identified by the comparative analysis. The dominant feature of the Sainsbury Wing is hierarchy, expressed both by the structure of space and the size of rooms. The 16 galleries which constitute the Sainsbury Wing are organised in three ranges of rooms. The central galleries are made taller and wider than the flanking ones and are linked in an enfilade. This design of the three ranges recalls the layout of a tripartite church, an ecclesiastical symbolism which emphasises the religious character of the works displayed.

By contrast, the distinguishing feature of Castelvecchio is the lack of syntactic centrality and the changing *genius loci*. The museum occupies two buildings⁶ and is articulated into four separate, rigorously linear sequences, each on different levels; by implication, its four components give the building four centres. However, a series of short passages organise the isolated episodes with solidity into a whole, by creating the nodal points of the itinerary and providing a pause between its parts.

Finally, the two museums have quite distinct principles organising their visual construction. In the Sainsbury Wing, although it seems that the design is more concerned with conventional rooms, and not with a free-flowing space, the open spatial relationships of the well-defined rooms create a sense of unity and flow, a succession of visual relationships, which is usually the characteristic of open spaces. The wide door openings and their axial or staggered alignment, allow a distant and synchronic visibility and shape powerful vistas. The majority of visual fields are not restricted to the local scale of a single space; they enter up to six rooms. If we look at the series of visual fields⁷ experienced along the major perspectival axis, we find that there is a visual access to the entire length and width of the gallery; in addition, the visitor can simultaneously see the spaces of the two sides by moving through the central aisle [5].

Like the Sainsbury Wing, Castelvecchio is characterised by distant visibility; but, unlike it, it is marked by visual fields⁸ which are quite restricted and views which seem to be frozen. Although visual information is again not limited to the local scale but there is visual access to almost the entire length of the sequence [6], visual fields are constructed so as not to allow any inspection of the spaces to come: it

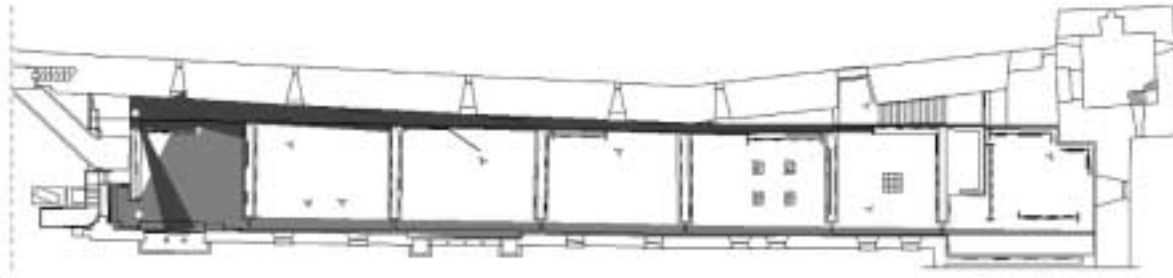

5 *Sainsbury Wing*
Isovists drawn from the cross perspectival axis, a, and the central axis, b. In figure c the line isovists from the two intersecting axes of the layout are superimposed, demonstrating that they provide views to the periphery of the plan

6 *Castelvecchio Museum*
Isovists drawn from vantage points in the painting galleries. The figure shows that views through the axes of movement are restricted and closed by blank walls



6

is no accident that perspective vistas are end-stopped by blank walls, and possible expansive visual fields are restricted by objects laid out so as to retain visual information.

How the two museums work

The analysis will now move from the more conspicuous spatial properties of the layouts to the less obvious ones which explain how the two museums work. It would be useful to begin by reviewing two issues that are of direct relevance to our study of the Sainsbury Wing: first, the Design Brief's (NG, HSI.69) focus on circulation as a key element of the layout – 'We want to avoid', it said, 'the danger of visitors bypassing rooms because they are out of the way or appear to be in a cul-de-sac'; and second, the architect's intention to create a hierarchy among the spaces. Venturi designed a 'basilica' style layout which enhances the predominance of the central space, intended to play the role of 'a public processional space' (NG, HSI.39). In dealing with the question of the circulation pattern, we carried out an observation study that involved recording the routes of 100 people through the galleries [7a], and counting flows in both directions across the thresholds of spaces.

At this point two observations are in order: first, visitors start moving in a systematic way, following the lines and the corners of the gallery, but then move randomly, returning to the same spaces or missing parts of the gallery. And second, the spaces that seem to lie outside the search track of visitors are those of the central sequence.

Let us discuss the first point further. People enter the gallery from the corner, the common point at which arrive both the staircase from the entrance and the link from the main building [2]. Upon

entering the first room (51) most visitors turn left and move through the rooms of the east side, following the alignment, or go right to the end of the perspective axis, and then follow the next axis, down to room 66. Few turn to the central enfilade, as it is unlikely that they will start their visit from the middle of the gallery space. Up to that point people move in a systematic way. The difficulty lies in deciding the continuation of their itinerary when they find themselves at the south end of the central axis. Beyond that point there is less consistency in their paths, which may also indicate confusion. Moving along the main axis seems to take them back home to the same starting point too quickly, while there are more things to explore on the other side of the axis; so, they continue linearly to the other corner of the gallery, and do not get to the central rooms. Some return to the same spaces or move randomly; the majority continue though the west sequence of rooms and find their way out through the main perspective axis.

Comparing the three sequences, we find that the complex of spaces on the east side has by far the highest movement rates. It is surprising that the central axis, the intended circulation spine of the gallery, designed to draw people through and enhance a sense of ceremony and procession, gets only one fourth of the movement while the east side takes twice this. This gap between observed movement and design intentions can be explained by the 'deep core structure' of the gallery and its simplified, but not intelligible layout.

The main vertical axis, which is identified with what we call the 'integration core' of the gallery, meaning the most accessible ('integrated') spaces from every part of the layout (Hillier and Hanson, 1984), is deep from the entrance and not directly

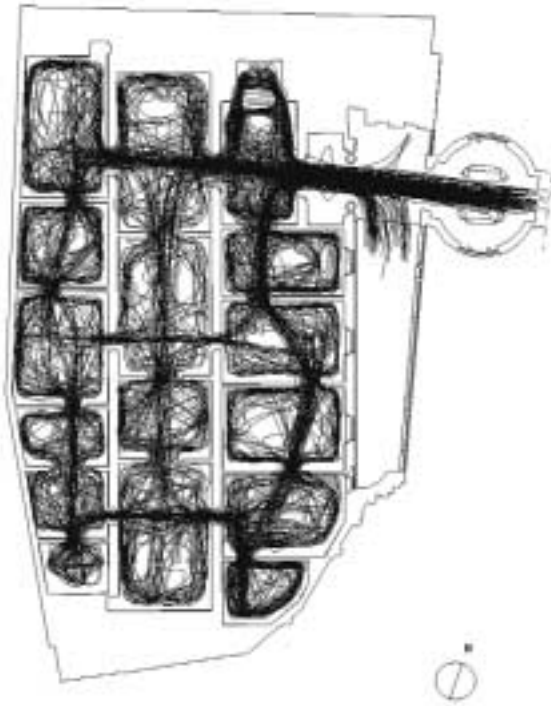

7a

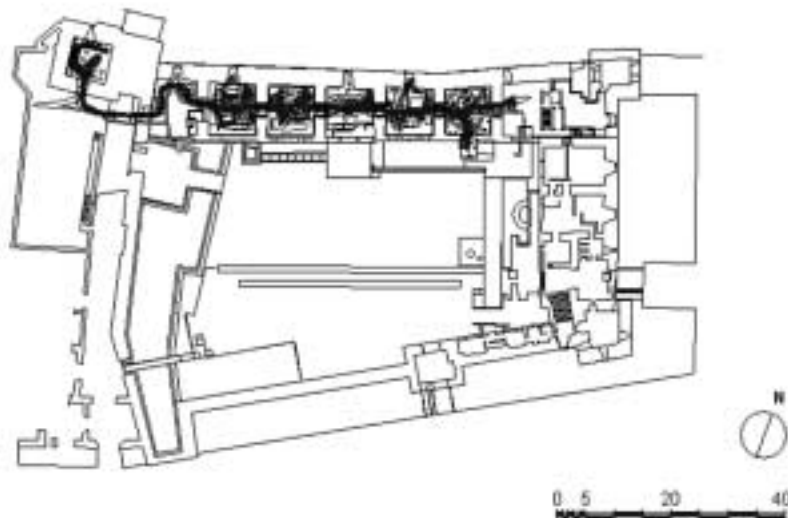
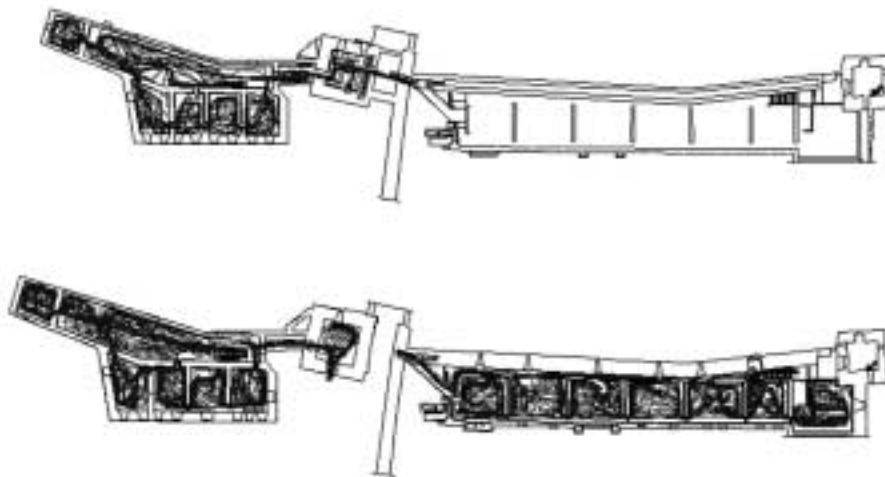

7b

7 Plans of the Sainsbury Wing, a, and Castelvecchio, b, showing the paths followed by visitors observed during their visit through the galleries

8 a Node graph (non-Hamiltonian) of the Sainsbury Wing
b The Hamiltonian graph showing that it would be possible to

make a single path by opening one more partition (drawn by B. Hillier)

9 The justified graph of Castelvecchio indicating the controlled overall structure of the path (global scale) and the exploratory nature of the path within wings (local scale)

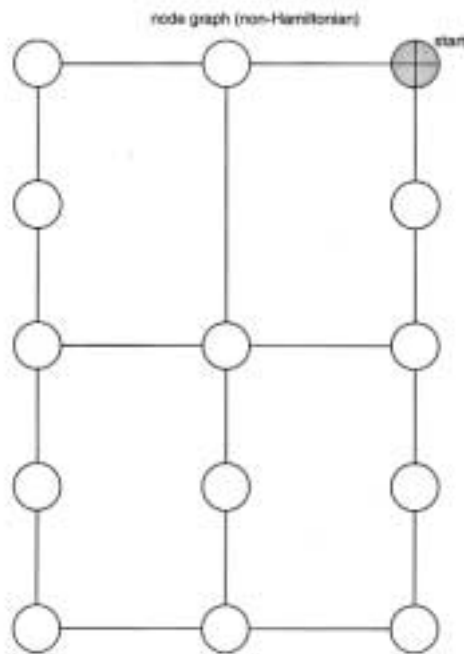

8a

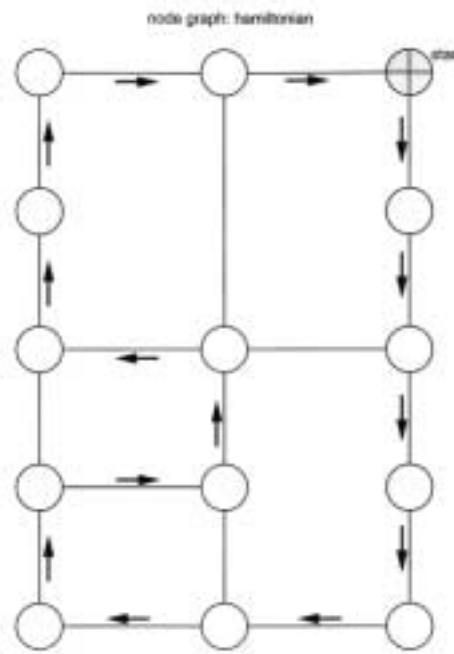

8b

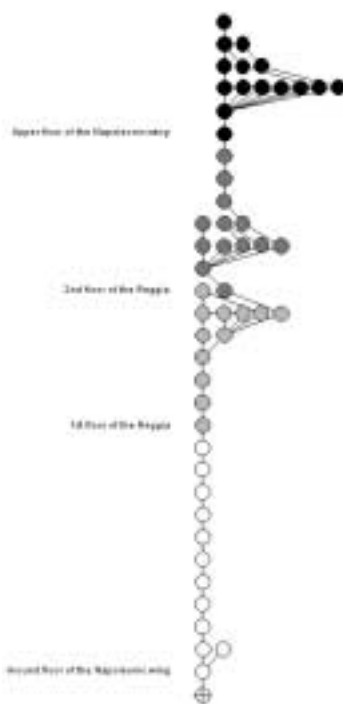

9

linked to the beginning of the route as it starts from the second space of the gallery. By implication, the 'deep core' does not connect to the global circulation, and so the local aspect of movement is independent from the global one. Moreover, the central axis can not act as an organising axis, since it gives little guidance to visitors as to the overall spatial logic of the layout.

It is also suggested that the gallery's simplistic structure does not create local problems, but on the contrary, it affects the whole layout and through-movement. This feature is related to a graph problem: if the visitor follows the route proposed by the gallery, he cannot end where he started. This

property, which refers to the existence of a single path passing through all the spaces ending where it started, is known as hamiltonian (Buckley and Harary, 1990). It is clear that the Sainsbury Wing's graph⁹ [8] is a non-hamiltonian graph:¹⁰ visitors cannot get to all spaces without crossing some of them more than once or missing out parts of the gallery – usually the central axis. The Sainsbury Wing is not an easily traversable gallery and its spatial properties do not encourage the explorative aspect of visitors' movement.

The argument presented here is numerically confirmed by a computer analysis of the layout using the theory and method of space syntax,¹¹ which allows us to describe and measure spatial variables and relate them to the observed aspects of space use. It has been found that the syntactic properties of depth¹² and connectivity¹³ have a powerful effect on the pattern of movement: if we correlate the observed movement rates with the reciprocal of depth from the entrance multiplied by connectivity, we find a strong relation, showing that 88 per cent of the differences in movement rates between spaces are due to the structure of the spatial layout. This result can perhaps be explained by the following argument. The fact that people move locally, since they cannot decide on the route from the entrance, and take decisions at different stages as they continue their itinerary through the galleries, implies that local conditions have a bigger effect on creating the pattern of movement in the Sainsbury Wing than does the global layout.

If we turn to Castelvecchio, on the other hand, we find that the overall visitor movement pattern is determined by the global layout: the high degree of sequencing, the limited choices and few possible diversions from the entrance to the exit, force movement along the well defined routes and structure a rather constrained circulation pattern.



10a



10b



10c

10 *Castelvecchio Museum*
 a The atypical arrangement of the exhibits: the viewer arrives at the statues from behind
 b Spatial relationships

between statues in the sculpture galleries
 c Visual connections between pictures in the painting galleries
 d The large painting at the far end acts as

a visual boundary that subdivides the space and as a physical obstacle to the visitor's progression towards the dead-end room behind



10d

Moreover, given the fact that the spatial logic of the museum cannot be learned from the entrance, in other words prior to exploration, the spatial progression becomes an act of discovery and visitors become 'space explorers' (Hillier, 1996). If we analyse the museum plan as a justified graph¹⁴ [9], we find that it has a 'deep tree' form, and structures a single general direction of movement. However, the circulation loops ('rings') offered on both floors of the 'Reggia' and the two parallel axes of movement provided by the painting galleries, introduce a measure of flexibility and choice into visitors' itineraries. Moreover, since the Castelvecchio graph is hamiltonian, visitors can return to the starting point without having to cross spaces already visited.

The single general direction of movement is clearly shown by the observation study, which involved tracing the routes of 33 people throughout their visit [7b], and recording their stopping points. Since there is one route from each sub-complex to every other, it is natural to find that the museum layout works evenly and as a single system, and that there is uniformity in the visiting pattern.

An interesting finding indicated that a significant number of stopping points was recorded in the transition spaces, in other words, the outdoor links between the different sequences which provide visitors with continuous reference to the surrounding space and guide their exploration. It seems that the detachment from the entrance that increases with the change in level, and the frequent changes of direction, confuse people about how the complex is composed as a whole.

Finally, it should be noted that visitors' traces reflect how the idiosyncratic spatial arrangements of Scarpa structure a meandering, rather than linear, pattern of movement. In other words, visitors are encouraged to move around and among the objects, shaping intersecting and encircling orbits of movement that are not kept to the perimeter of rooms but, on the contrary, fill the space.¹⁵

These observations seem to lead to the suggestion that in both cases an interesting tension arises between the global and the local properties of space, as visitors move around. On the one hand, at Castelvecchio the rather dictating overall structure of the path (single sequence) is coupled with the rather exploratory nature of the path within rooms (local movement); while on the other, in the Sainsbury Wing, there is a strongly localised movement, independent from the global circulation of the gallery, which works in a different way than planned.

Display layout

Having explored one parameter of the gallery space, its spatial configuration, we now move to the second, the display layout. 'The aim of the arrangement of the collection (of the Sainsbury Wing) is to create spaces for the paintings, so that they can be seen in a broadly chronological sequence, with contemporaneous paintings from different geographical locations being shown in rooms of close proximity.' This statement from the original Brief is, we believe, shaped in the spatial layout of the galleries.

The powerful axially and the synchronic visibility become the spatial tools that serve the placement of symmetrically arranged paintings, in strategic positions and in combination with the open spatial relationships, they allow for freedom and flexibility in expressing thematic or aesthetic relationships between works. Paintings with great visual strength, such as Cima's and Pollaiuolo's works, with perspective construction and centrality of composition, are placed at the end of long lines of sight and are used as 'attractors'. It is of interest to note that the technique of axial vistas respects the scale of the paintings displayed. For example, Jan Van Eyck's *The Arnolfini Marriage*, with the small scale and detailed representation, is put on the axis, but in a small cul-de-sac room that provides seclusion and containment, and is visually shielded.

The determinant property of the Sainsbury Wing is that it is all about glimpses and views from, through and into spaces to come, or spaces just navigated. So the arrangement is built on vistas that punctuate the narrative. The display is structured as a network of galleries whose door openings become the frames of visual compositions. It is no accident that the gallery is centred on the door rather than on the wall.

It is, therefore, tempting to consider that there is a spatial mannerism, in the sense that doorways are arranged diagonally to create a proliferation of visual connections, large and imposing paintings are placed as stops to long vistas, major works are put on the axis of the deepest spaces. This mannerism aims to create a visual effect and thus induce movement, 'draw people through and persuade them to linger (in the deepest spaces) rather than rushing through'. (NG, HSI.39)

Conversely, at Castelveccchio objects are not placed axially but off-centre; they are not positioned at the end of long lines of sight but on the sides of the main axes. In other words, the emphasis is put on what happens locally and the viewer is thus led step by step from one display to the next. Spatial relationships between statues in the sculpture galleries [10a, b] (Stavroulaki and Peponis, 2003), visual connections between pictures in the painting galleries [10c], tend to be created within the boundaries of a room or a spatial unit. The fact that paintings are imbued with three-dimensionality may also be accounted for by this. At Castelveccchio, the idea of walls as extensions of pictures is systematically rejected. Either offset from the walls, suspended from the ceiling, or mounted on free-standing easels, specially designed by Scarpa, paintings are treated as three-dimensional objects, arranged in relation to the viewer's field of vision as he enters or leaves the room. For instance, in the 'Pisanello room' or the 'Mantegna room', on the first and the second floor of the Reggia building respectively, a set of easels forms one view, to be seen together to bring out common characteristics and differences; their arrangement creates a series of overlapping planes which encourage visual comparisons between versions of the same subject by different artists.

The determinant feature of Castelveccchio is that it discourages a static point of view. Interestingly, the viewer comes up to the objects from behind, an atypical arrangement that requires him to move around and among them, in order to face their front and capture the sense of the whole [10a]. 'I could have turned them ...' says Scarpa, 'but it seems that this is the visitor's duty ... to look to right and left ... come back to see it again, and walk around it' (Olsberg, et al, 1999).

Also, unlike the Sainsbury Wing, Castelveccchio offers a space organised in asymmetrical arrangements that are the harmonious result of discordant elements. For example, the statues in the sculpture galleries are positioned asymmetrically, along the strong perspectival axis, and the exhibits in the main galleries of the Reggia are carefully disposed off-centre and organised in a sparse arrangement, which combines vertical and horizontal elements together. This display practice enhances the sense of movement within the room and becomes a tool that allows *reordering space*. The big scale painting representing the *Death of the Virgin*,¹⁶ [10d] positioned perpendicularly to the wall, at the far end, determines the visual orientation, but it also acts as a visual boundary that subdivides space, as well as a physical obstacle to the visitor's progression towards the visually blocked dead-end room behind the picture. It seems that the rule which directs the organisation of space is the careful control of visual fields; the main axes reveal and simultaneously conceal; they allow narrow glimpses of rooms to come, in order to encourage movement by suggesting the continuation of the route, but they retain information about their content.

So, the mannerism at Castelveccchio lies in Scarpa's careful arrangement of objects and the fact that this becomes an integral part of the design of space. On the whole, exhibits are arranged in the way they should be seen, as interpreted by Scarpa, often in innovative ways;¹⁷ groupings and compositions are deliberately created for visual delectation, for timeless, aesthetic experience.

To summarise, the two museums seem significantly different in terms of the display layout. In the Sainsbury Wing, paintings, symmetrically arranged at the end of vistas, transform the circulation axes into goal-directed tracks, and are confronted frontally. At Castelveccchio, objects, asymmetrically arranged, become the short-term goals, revealed through a succession of diagonals. In the Sainsbury Wing, space tends to be manipulated to enhance exhibits; at Castelveccchio exhibits are manipulated to enhance space.

Spatial character of the itinerary

We now come to our third issue, the spatial character of the itinerary, as a by-product of both the spatial layout and the arrangement of the display. On the whole, the Sainsbury Wing is designed in the Beaux-Arts conception of circulation; the visitor is considered as a peripatetic being who gathers information from accumulative juxtapositions of paintings. The importance of the whole collection

seems to override the value of the individual work of art. The intention is to create a unified and coherent spatial experience. Moreover, the formally organised layout emphasises the public aspect of a visit rather than encouraging a more private appreciation of the paintings.

This brings us to our last comment on the Sainsbury Wing: the elimination of the sense of self-exploration, as surprises are already set up for the viewer. For instance, for the visitor who is moving through the central spaces, on the axis of symmetry, the long 'tunnel' isovist which strikes the paintings at both ends at a right angle, and is designed to separate the viewer from the moment he will be able to appreciate them and thus intensify his anticipation, produces the opposite effect: the key paintings become 'negative attractors'. The fact that the central sequence is omitted from the majority of visitors' itineraries may also be due to this.

Moreover, the repetitive perspective vistas through spaces, deprive the visitor of any sense of discovery while, at the same time, providing a rush of information changing quickly as he moves around. The spatial experience of the itinerary becomes deterministic in the sense that there is a 'repetitive and symmetrical pattern of visual exposure'. In other words, though the sequence is not strong and rigid, the spatial experience accommodates 'little probability and a great deal of repetition and certainty' (Psarra, 1997).

The opposite tendencies are identified at Castelvecchio. Scarpa has sculpted a space that demands careful observation and extensive exploration. At first sight, spatial experience might seem deterministic: the existing configuration imposes a predetermined viewing sequence and maximises depth without leaving room for shortcuts or alternative paths. But closer inspection reveals its dynamic character, which counteracts the strong sequencing. The route consists of a series of sudden discoveries, and accommodates a great deal of uncertainty. Scarpa delays access to a final understanding of how the spatial sequences relate to

each other, and it is precisely this prolonging of sequential experience coupled with the carefully controlled vistas that intensifies the mystery of parts and objects unseen, and enhances the sense of self-exploration.

This stimulating effect of exploration is further reinforced by the viewer's step by step progression. For the moving observer, there are no sharp changes in visual fields, and information is received gradually. On the whole, it seems that we have to do with a slow narrative sequence that winds its way through a considerable number of spaces, lengthy intervals and breaks. Additionally, as already discussed, the works themselves are organised to generate a slowly-paced rhythm of perception; pictures and sculptures subdivide the route, stand in the way as temporary obstacles, and require the viewer to slow down by offering short-term goals, and screening him from what is ahead.

Conclusion

The conclusion is that in the case of the Sainsbury Wing, the layout of the display uses and exploits the qualities of the setting in order to maximise the impact of the exhibits, but the power of space overrides the intentions of the curators when it comes to the morphology of movement and exploration. In the case of Castelvecchio, Scarpa organises objects in a manner which articulates and elaborates space, and this does seem to have an effect, by making the visitor-culture more exploratory, and the museum visit itself an architectural experience, a spatial event.

These strategic differences seem to suggest that exhibition set-up can work with the building design to create a richer spatial experience, and conversely, that the relation between building design and exhibition set-up can create unanticipated problems that detract from the quality of experience. So, we hope this paper has illustrated that space is a powerful variable in museum experience, and that the latter is a synthesis of the effects of building and exhibition design working together to produce a spatial structure.

Notes

1. To use Langer's term for what we can communicate by means of words, as opposed to what can be conceived through a kind of semantic other than language, characterised as 'non-discursive' or 'presentational' form. For a further discussion on the absence of a language of space see Hillier, 1996.
2. *Comments on gallery plan and Venturi scheme 2*, 28 May 1986, NG, HSI.39. The early Renaissance collection of the National Gallery comprises mostly Northern and Italian works produced between 1260 and 1510. The galleries were specially created for this collection for two reasons: first, it was the least well served by

- the existing galleries, and second, it was not expected to grow appreciably in the future.
3. The Castelvecchio Museum occupies a fourteenth-century fortified castle, by the river Adige, which was extended in the eighteenth century and converted into a municipal museum in 1926. It displays mainly Veronese sculptures and paintings from the twelfth to the nineteenth century.
4. Scarpa's involvement in Castelvecchio dates from 1958, when he undertook the rearrangement of the oldest wing of the museum to house the exhibition 'Da Altichiero to Pisanello', and the design of the exhibition

- installations. The restoration and reorganisation of the museum was carried out in two phases, between 1958 and 1964, and the last phase was completed in 1974. The museum was inaugurated on 19 December 1964. Finally, it should be noted that the displays, as set up and arranged by Scarpa, remain fixed.
5. It is also of interest to note that Castelvecchio was among the galleries in Italy visited by the architects of the National Gallery as an inspirational journey before the design of the Sainsbury Wing.
6. The Castelvecchio museum is split into two separate wings, the 'Reggia' wing, the original

residential building, and the 'Napoleonic' wing, the addition of the eighteenth century; the sculpture and the painting galleries discussed in this paper are situated on the ground and the upper floor of the newest wing respectively.

7. This paper makes use of the idea of isovist developed by Benedict, originally defined as 'the set of all points visible from a given vantage point in space and with respect to an environment' (M. L. Benedict, 1979). Here the isovists are drawn from the two major axes of the layout in order to represent everything that can be seen through gradual movement along these axes and describe how the museum is experienced as a series of visual fields.
8. The isovists are drawn from central points in the painting galleries.
9. The graph is drawn by representing spaces with circles and connections of permeability by linking lines. The dead-end spaces are omitted since they cannot evidently be part of a hamiltonian path.
10. However, it would be possible to make a single path by opening one more partition between space 58 and 64, as shown in [7].
11. Space syntax is a theory applied to the built environment for describing layouts – in terms of the relational pattern of spaces – and associating them with social function and cultural meaning. It was developed in the late 1970s in the unit for Architectural Studies at University College London under the direction of Professor Bill Hillier (Hillier and Hanson, 1984; Hillier, 1996).
12. The syntactic property of depth is measured on the basis of the convex map (produced by the subdivision of the layout into the fattest and fewest convex spaces that are needed to cover the whole system) and describes how far a space is in a system, by measuring the minimum number of steps that must be taken to arrive in that space from the selected one.
13. Connectivity is a local syntactic value which measures the number of other spaces which are directly connected to a space.
14. A justified graph is drawn from a

particular point (in our case, the museum entrance) and all spaces with the same depth value are lined up horizontally above the carrier (Hillier and Hanson, 1984).

15. If we look closely at the morphology of individual paths, we see that at Castelvecchio, the rate of changes in direction as people explore the displays is twice as frequent as in the Sainsbury Wing. Interestingly, a similar ratio is found when we look comparatively at the number of times each visitor 'crosses' his own path by going from one point within a room to another.
16. The 'Dormitio Virginis' is the work of M. Giambono (1420-1462).
17. For instance, the group of the 'Crucifixion', displayed in the fourth room of the sculpture galleries, is presented in a different place from the original arrangement. It should be noted that a number of Scarpa's drawings illustrate the ideas that he had been exploring before the final grouping and installation of the three statues.

References

- Benedict, M. L. (1979). 'To Take Hold of Space: Isovists and Isovists Fields', *Environment and Planning B*, 6, pp47-65.
- Buckley, F. and Harary, F. (1990). *Distance in Graphs*, Addison-Wesley, Redwood City, California; Wokingham.
- Hillier, B. and Hanson, J. (1984). *The Social Logic of Space*, Cambridge University, Cambridge.
- Hillier, B. (1996). *Space is the Machine*, Cambridge University, Cambridge.
- Langer, S. K. (1951). *Philosophy in a New Key. A study in the symbolism of reason, rite and art*, Harvard University Press, Cambridge, Massachusetts.
- National Gallery Archive, *The National Gallery Extension Brief*, 21.2.1986, NG, HSI.69. National Gallery Archive, Comments on Gallery Plan and Venturi Scheme 2, 23 May 1986, NG, HSI.39.
- Olsberg, N. et al (ed) (1999). *Carlo Scarpa, Architect: intervening with history*, Canadian Centre for Architecture, Montreal; Monacelli Press, New York.
- Psarra, S. (1997). 'Geometry and Space in the Architecture of Le Corbusier and Mario

Botta'. In *Proceedings of the 1st International Space Syntax Symposium*, London, pp32.1-32.29.

Stavroulaki, G. and Peponis, J. (2003). 'The spatial construction of seeing at Castelvecchio'. In *Proceedings of the 4th International Space Syntax Symposium*, London, pp66.1-66.14. Also in: <http://www.spacesyntax.net/symposia/SSS4/fullpapers/66Stavroulaki-Peponis.pdf>

Acknowledgments

The author is indebted to Professor B. Hillier and to R. Diamond from the Bartlett School of Graduate Studies for their continuous and generous support. She would also like to thank the National Gallery and especially P. Fortheringham and R. Cripps (Building and Facilities Department) for supplying the gallery plans, I. Hunter and M. Watton (Libraries and Archive Department) for facilitating the archive search, and Dr A. Sturgis, Exhibitions and Programme Curator, for a very useful discussion on the rearrangement of the collection. Also, she is indebted to the architect A. di Lieto from the Castelvecchio Museum for her interest in the research and her assistance with the drawings.

Biography

Kali Tzortzi is an archaeologist and museologist. Having completed Masters Degrees in Archaeology, and in Museum Studies at the Ecole du Louvre, Paris, she is a doctorate candidate at the Bartlett School of Graduate Studies, UCL. She has been involved in archaeological research at the Ministry of Culture, Athens, and more recently, worked as a Project Consultant in Space Syntax Ltd, London. Her primary interest is in museum space and its relation to patterns of use. She has published a book on the temple of Apollo Epikourios, Greece (*A Journey through Space and Time*, 2001) and contributed to the *Blackwell Companion to Museum Studies* (2005).

Author's address

Kali Tzortzi
5, Vernardaki Street
11522 Athens
Greece
kalit@otenet.gr