

**Comparison of concrete rheometers:
International tests at MB
(Cleveland OH, USA)
in May, 2003**

Editors:

Chiara F. Ferraris, Lynn E. Brower

Authors (alphabetical order):

**Denis Beaupré, Frédéric Chapdelaine,
Peter Domone, Eric Koehler, Lin Shen, Mohammed Sonebi,
Leslie Struble, David Tepke, Olafur Wallevik,
Jon E. Wallevik**



National Institute of Standards and Technology
Technology Administration, U.S. Department of Commerce

NISTIR 7154

Comparison of concrete rheometers: International tests at MB (Cleveland OH, USA) in May, 2003

Editors:

Chiara F. Ferraris, National Institute of Standards and Technology (USA)
Lynn E. Brower, Master Builders Technologies (USA)

Authors (in alphabetical order):

Denis Beaupré, Laval Univ., (Canada)
Frédéric Chapdelaine, Laval Univ (Canada)
Peter Domone, University College London (UK)
Eric Koehler, University of Texas, Austin (USA)
Lin Shen, Univ. of Illinois at Urbana-Champaign (USA)
Mohammed Sonebi, Advanced Concrete and Masonry Centre (UK)
Leslie Struble, Univ. of Illinois at Urbana-Champaign (USA)
David Tepke, Pennsylvania State Univ. (USA)
Olafur Wallevik, The Icelandic Building Research Institute, (Iceland)
Jon E. Wallevik, Norwegian Univ. of Science and Technology, (Norway)

September 2004



U.S. DEPARTMENT OF COMMERCE
Donald L. Evans, Secretary

TECHNOLOGY ADMINISTRATION

Philip J. Bond, Under Secretary of Commerce and Technology
NATIONAL INSTITUTE OF STANDARDS AND TECHNOLOGY
Arden L. Bement, Jr., Director

Disclaimer

Commercial equipment, instruments, and materials mentioned in this paper are identified to foster understanding. Such identification does not imply recommendation or endorsement by the National Institute of Standards and Technology (NIST), nor does it imply that the materials or equipment identified are necessarily the best available for the purpose.

During the trial in Cleveland (OH, USA), on May 2003, to ensure proper use, a person designated by the designer or the designer himself operated the instruments and described their operation in this report. After each test all data were immediately collected in electronic form on specially labeled diskettes/CD-ROMs, for later analysis.

The role of NIST was to coordinate and foster the rheometer study. Dr. Chiara Ferraris is the chair of ACI 236A, “Workability of Fresh Concrete”, and in this role she organized the tests and edited the report. She is not one of the authors, but only an editor. Lynn Brower, co-editor, is the secretary of ACI 236A.

The opinions expressed in this report are not endorsed by NIST and they reflect only the opinion of the authors.

Preparation of the report

Editors

Chiara F. Ferraris, National Institute of Standards and Technology, Gaithersburg (USA)

Lynn Brower, Master Builders, Cleveland OH (USA)

Authors (alphabetical order)

Denis Beaupré, Laval Univ., Quebec (Canada)

Frédéric Chapdelaine, Laval Univ., Quebec (Canada)

Peter Domone, University College London (UK)

Eric Koehler, University of Texas, Austin (USA)

Lin Shen, Univ. of Illinois at Urbana-Champaign (USA)

Mohammed Sonebi, Advanced Concrete and Masonry Centre, Paisley (UK)

Leslie Struble, Univ. of Illinois at Urbana-Champaign (USA)

David Tepke, Pennsylvania State Univ. (USA)

Jon E. Wallevik, Norwegian Univ. of Science and Technology, Trondheim (Norway)

Olafur Wallevik, The Icelandic Building Research Institute, Reykjavik (Iceland)

Contact

Chiara F. Ferraris

NIST
100 Bureau drive, MS 8621, Gaithersburg MD 20899 (USA)

Phone: +301-975 6711

Fax: +301-990 6891

E-mail: clarissa@nist.gov

Participants in the tests at MB in Cleveland (OH), USA



1st row (left to right): Jinhua Jin, Jon Wallevik, Joe Daczko, Chiara Ferraris, Kevin M. Murnin, Lynn Brower, Frédéric Chapdelaine, Celik Ozyildirin

2nd Row (left to right): Mohammed Sonebi, Gary Crawford, Leif Wathne, Mark Piechuta, George Lianopoulos, Tyler Agner, Eric Koehler, Mark Kurtz, Denis Beaupre, David Tepke, Olafur Wallevik

Affiliations of participants (in alphabetical order): (* not present)

Advanced Concrete and Masonry Centre, Paisley (UK): Mohammed Sonebi

FHWA (USA): Gary Crawford, Leif Wathne

The Icelandic Building Research Institute, Reykjavik (Iceland): Olafur Wallevik

Laval Univ., Quebec (Canada): Denis Beaupré, Frédéric Chapdelaine

Master Builders, Cleveland OH (USA): Tyler Agner, Lynn Brower, Joseph Daczko, Eric Kinzle, Mark Kurtz, George Lianopoulos, Mark Piechuta

National Institute of Standards and Technology, Gaithersburg (USA): Chiara F. Ferraris, Nicos Martys

Norwegian Univ. of Science and Technology, Trondheim (Norway): Jon E. Wallevik

Pennsylvania State Univ. (USA): David Tepke

University College London (UK): Peter Domone*, Jinhua Jin

Univ. of Illinois at Urbana-Champaign (USA): Lin Shen*, Leslie Struble*

University of Texas, Austin (USA): Eric Koehler, Kainan Bodenlos

Virginia Transportation Research Council (USA): Celik Ozyildirin

W.R. Grace & Co. (USA): Kevin M. Murnin

Foreword

The American Concrete Institute (ACI) sub-committee 236A, “Workability of Fresh Concrete,” upon its creation in fall 1999, immediately faced the task of determining appropriate methods to measure concrete workability. Using a material science-based approach, workability should be defined using rheological methods. The instrument most used for determining rheological parameters is a rheometer. There are several concrete rheometers used around the world that have significant design differences, but no standard method with which to compare their results. ACI 236A members determined that, as no reference material was available, one method to compare the rheometers would be to test them under the same conditions using the same concrete mixtures. A tentative analysis comparing two rheometers was performed [1, 2] but did not involve most of the available rheometer designs. A first set of round-robin testing was organized in 2000, allowing the direct comparison of five types of rheometers [3]. This first comparison test was sponsored by the Concrete Research Council (CRC) of ACI and by industry. It was held at the Laboratoire Central des Ponts et Chaussées (LCPC) facility in Nantes, France, on October 23-27, 2000. The rheometers selected included commercially available concrete rheometers (four), and one coaxial concrete rheometer developed for research.

After the test and subsequent report it was apparent that some issues were still unresolved; therefore ACI 236A committee requested an extension grant from CRC and more industrial support to conduct a second set of round-robin testing. The second test was performed on May 19-23, 2003, in the laboratory of Masters Builders, a Degussa Construction Chemical company, in Cleveland OH, (USA).

The authors of this report are principal investigators who participated in this second test and contributed to the report. This report describes the tests performed and the results obtained. Following the same procedure as in the first comparison test, this report was not published as an ACI document and therefore was not submitted to the Technical Activities Committee (TAC) for approval. There are two reasons that this is not an ACI document: 1) ACI documents are guidelines and practice recommendations, not research reports; 2) all ACI reports are consensus documents balloted and approved by the members of a committee, while this report only reflects the views and opinions of the authors. All members of ACI 236A were invited to review the document prior to publication (as shown in the acknowledgements). It was also discussed during the regular meetings of ACI 236A during Fall 2003 and Spring 2004.

Acknowledgements

This project was not possible without the financial support of the ACI Concrete Research Council. Its support offset the cost of the transportation of the rheometers from Canada and UK to the test site at Master Builders (MB), a Degussa Construction Chemicals Company, in Cleveland, Ohio (USA). We are thankful for the hospitality and the professionalism of the staff of MB, who welcomed the international team for the weeklong tests. We would like to acknowledge the participation of MB staff, in particular: Tyler Agner, Lynn Brower, Joseph Daczko, Eric Kinzle, Mark Kurtz, George Lianopoulos, and Mark Piechuta. They organized the tests, prepared and tested all of the concrete used for this project, and conducted all of the concrete quality control measurements.

We would also like to thank all the participants and their organizations for their involvement in the planning and execution of this comparison. Their names are listed in the participants list placed before the foreword. Also, MB should be thanked for providing their expertise to administer the funds provided by CRC.

The authors would also like to **thank all the reviewers** for their efforts in reading this rather large report (in alphabetical order): Phil Banfill (Heriot-Watt Univ. , UK), Peter Claisse (Coventry Univ., UK), Edward Garboczi (NIST, USA), F. de Larrard (LCPC, France), Nicos Martys (NIST, USA), Walter Rossiter (NIST, USA), T. Sedran (LCPC, France)

We would also like to thank the members of ACI 236A for their lively discussion during ACI conventions and their support of this study.

Table of Contents

1.	<u>INTRODUCTION</u>	1
2.	<u>CONCRETE MIXTURES</u>	4
2.1.	<u>CONSTITUENTS</u>	4
2.2.	<u>MIXTURE PROPORTIONS</u>	5
2.3.	<u>MIXTURE PRODUCTION</u>	11
2.4.	<u>MIXTURE MEASUREMENTS</u>	11
3.	<u>CONCRETE RHEOMETERS</u>	13
3.1.	<u>THE BML RHEOMETER</u>	13
3.1.1.	<i>Description of the apparatus</i>	13
3.1.2.	<i>Analysis of data</i>	14
3.2.	<u>BTRHEOM RHEOMETER</u>	16
3.2.1.	<i>Description of the apparatus</i>	16
3.2.2.	<i>Test procedure</i>	17
3.2.3.	<i>Analysis of the data</i>	17
3.3.	<u>THE IBB RHEOMETER</u>	19
3.3.1.	<i>Description of the apparatus</i>	19
3.3.2.	<i>Analysis of the data</i>	20
3.4.	<u>THE TWO-POINT RHEOMETER</u>	22
3.4.1.	<i>Description of the apparatus</i>	22
3.4.2.	<i>Test procedure</i>	22
3.4.3.	<i>Analysis of the data</i>	23
3.5.	<u>UIUC RHEOMETER (USED ONLY FOR OIL TESTS)</u>	25
3.5.1.	<i>Description of the apparatus</i>	25
3.5.2.	<i>Test procedures</i>	25
4.	<u>MEASUREMENTS USING OIL</u>	29
4.1.	<u>MATERIALS AND PROCEDURE</u>	29
4.2.	<u>RESULTS AND DISCUSSION</u>	29
5.	<u>RESULTS FOR CONCRETE AND MORTAR MIXTURES</u>	32
6.	<u>DISCUSSION OF RESULTS WITH CONCRETE AND MORTAR</u>	36
6.1.	<u>CORRELATION BETWEEN SINGLE POINT TESTS AND RHEOMETER RESULTS FOR CONCRETE</u>	36
6.2.	<u>COMPARISON BETWEEN RHEOMETERS</u>	38
6.2.1.	<i>General Trends</i>	38
6.2.2.	<i>Comparison of measurements on concrete mixtures</i>	39
6.2.3.	<i>Ranking of the concrete mixtures by the various rheometers</i>	46
6.2.4.	<i>Comparison of Results from Phase I (2000) and Phase II (2003) [3]</i>	47
6.3.	<u>REPEATABILITY OF DATA</u>	51
6.4.	<u>RELATIVE VISCOSITY: MORTAR AND CONCRETE</u>	54
7.	<u>SUMMARY OF FINDINGS</u>	57
8.	<u>RESOLUTION OF PHASE I RECOMMENDATIONS AND RECOMMENDATIONS FOR FUTURE WORK</u>	59
8.1.	<u>RESOLUTION OF PHASE I RECOMMENDATIONS</u>	59
8.2.	<u>RECOMMENDATIONS FOR FUTURE WORK</u>	59
9.	<u>REFERENCES</u>	61

List of Figures

<u>Figure 1: The aggregates used in the Cleveland test: Sand and gravel particles. As shown to the right, the aggregate size can be larger than 25 mm due to elongated shape.</u>	5
<u>Figure 2: U-Box schematic and dimensions</u>	12
<u>Figure 3: V-Funnel schematic and dimensions</u>	12
<u>Figure 4. The ConTec BML Viscometer.</u>	13
<u>Figure 5 : To the left: The inner and outer cylinder of the BML. To the right: The computed shear stress τ (in Pa) for the C-200 system [21]. $\tau_o = 200$ Pa, $\mu = 20$ Pa.s, $N = 0.076$ rad/s (0.48 rps).</u>	14
<u>Figure 6: A three-dimensional- and a top view of the coaxial cylinder viscometer.</u>	15
<u>Figure 7: Kinematic viscosity of CylEso 1000 measured with tube viscometer (oil testing laboratory Fjölver) and the BML.</u>	15
<u>Figure 8: The BTRHEOM rheometer showing the blades at the top and bottom of the bucket containing the concrete [8].</u>	16
<u>Figure 9: Picture of IBB Rheometer</u>	19
<u>Figure 10: Picture of portable IBB Rheometer (a) in the lab and (b) on a construction site</u>	20
<u>Figure 11 - IBB Calculation Example. The range of speed are 0 rad/s to 0.15 rad/s.</u>	21
<u>Figure 12 -a) dimensions for the IBB H impeller; b) dimensions for the IBB portable H impeller</u>	21
<u>Figure 13: Impeller and bowl dimensions (in mm) of the Two-point test</u>	24
<u>Figure 14: General arrangement of the two-point test</u>	24
<u>Figure 15. Parallel-plate concrete rheometer at UIUC.</u>	26
<u>Figure 16: Sketch of UIUC rheometer (A) and detailed dimensions of the rheometer (B).</u>	27
<u>Figure 17: Reproducibility of rheological measurements using the UIUC rheometer</u>	28
<u>Figure 18: Range of Bingham properties measured in tests at MB</u>	35
<u>Figure 19: Range of Bingham properties measured in tests at LCPC</u>	35
<u>Figure 20: Relationships between yield stress/yield term and slump for concrete mixtures</u>	36
<u>Figure 21: Relationships between yield stress/yield term and slump flow for concrete mixtures</u>	37
<u>Figure 22: Relationships between plastic viscosity/viscosity term and V-funnel flow time for concrete mixtures</u>	37
<u>Figure 23: Relationships between plastic viscosity/viscosity term and T_{50} times for concrete mixtures</u>	37
<u>Figure 24: Plastic viscosity vs. concrete or mortar mixtures. The lines connecting the points are only used to guide the eye and are not meant as implication of a relationship between the points.</u>	38
<u>Figure 25: Yield stress vs. concrete or mortar mixtures. The lines connecting the points are only used to guide the eye and are not meant as implication of a relationship between the points.</u>	38
<u>Figure 26: Yield stress correlations</u>	42
<u>Figure 27: Yield stress correlations (cont)</u>	43
<u>Figure 28: Plastic viscosity correlations</u>	44
<u>Figure 29: Plastic viscosity correlations (cont)</u>	45
<u>Figure 30: Yield tress correlations obtained at LCPC and MB for concrete mixtures</u>	49
<u>Figure 31: Plastic viscosity correlations obtained at LCPC and MB for concrete mixtures</u>	50
<u>Figure 32: Relative viscosity (using D2M5Mort as a reference) for each rheometer as a function of the mixture number.</u>	55

List of Tables

<u>Table 1: Aggregate particle size distributions</u>	4
<u>Table 2: Mixture proportions and measurements for Day 1 mixtures. See section 2.4 for the measurements details.</u>	8
<u>Table 3: Mixture proportions and measurements for Day 2 mixtures. See section 2.4 for the measurements details.</u>	9
<u>Table 4: Mixture proportions and measurements for Day 3 mixtures. See section 2.4 for the measurements details.</u>	10
<u>Table 5: Results with oil using the various rheometers.</u>	31
<u>Table 6: Results obtained with all mixtures. The mixture # is given to simplify the plot of some data in graphs.</u>	33
<u>Table 7: Correlation coefficients R for yield stress values of concrete mixtures</u>	39
<u>Table 8: Correlation coefficients R for plastic viscosity of concrete mixtures</u>	39
<u>Table 9: Critical values for the absolute value of the correlation coefficient R of a sample extracted from a normal distribution. A is the confidence, and $\gamma = n - 2$, where n is the number of points.</u>	40
<u>Table 10: Coefficients of regression A and B for yield stress of concrete mixtures ($Y = A X + B$)</u>	41
<u>Table 11: Coefficients of regression A and B for plastic viscosity of concrete mixtures ($Y = A X + B$)</u>	41
<u>Table 12: Ranking of the yield stress of the concrete mixtures as determined by the rheometers. The mixtures are ranked in increasing order of yield stress from 1 to 15.</u>	46
<u>Table 13: Ranking of plastic viscosity of the concrete mixtures as determined by the rheometers. The mixtures are ranked in increasing order of yield stress from 1 to 13.</u>	46
<u>Table 14: Correlation coefficients, R, for yield stress values (MB and LCPC) for the concrete mixtures.</u>	47
<u>Table 15: Correlation coefficients, R, for plastic viscosity (MB and LCPC) for the concrete mixtures.</u>	48
<u>Table 16: Regression coefficients A and B for yield stress (MB and LCPC) for the concrete mixtures.</u>	48
<u>Table 17: Regression coefficients A and B for plastic viscosity (MB and LCPC) for the concrete mixtures.</u>	48
<u>Table 18: Average yield stress for the mixture repeatability. No standard deviation was calculated when only one value was available.</u>	52
<u>Table 19: Average plastic viscosity for the mixture repeatability. No standard deviation was calculated when only one value was available.</u>	52
<u>Table 20: Average for the non-rheometer tests</u>	53
<u>Table 21: Average relative viscosity and coefficient of variation (using D2M5Mort as a reference).</u>	56

1. Introduction

The use of concrete with appropriate rheological properties is paramount for determining the performance and durability of the material. Rheological properties control the flow of the concrete in mixing, placement, consolidation and finishing. Typically during a project, all of these characteristics are referred to as workability and often measured using only the slump test (ASTM C 143). Unfortunately, this test does not completely define all the rheological properties of fresh concrete, particularly for specialty concretes such as self-consolidating concretes (SCC).

It is generally agreed that the flow of a concrete can be usually described using a Bingham equation. This equation is a linear function of shear stress (the concrete response) versus shear rate. The general form of this relationship is:

$$\tau = \tau_0 + \eta\dot{\gamma} \quad [1]$$

where τ is the shear stress and $\dot{\gamma}$ is the shear rate. Two parameters provided by the Bingham equation are the yield stress, τ_0 , (y-intercept of the line) and the plastic viscosity, η (slope of the line). The yield stress is analogous to the amount of shear stress required to initiate flow whereas the plastic viscosity describes the resistance to flow once the concrete is flowing. The yield stress correlates reasonably well with the slump value, but the plastic viscosity does not. The existence of the plastic viscosity helps explain why concretes with the same slump may behave differently during placement.

In certain instruments, it is not possible to measure the shear stress and shear rate because the geometry and the flow pattern of the fluid are not correctly known. In this case, Tattersall [18] was the first to introduce the concept of measuring the torque (related to the shear stress) and the velocity of rotation of the vane or inner cylinder (related to shear rate). In a plot of the torque versus the rotational speed, the slope of the linear curve and the intercept at zero speed are called, respectively, H and G .

To calculate the plastic viscosity value as H or η , the slope of the torque vs. rotational speed curve or shear stress vs. shear rate curve respectively is calculated by linear regression. The intercept of the linear regression at zero shear rate or zero rotational speed is τ_0 or G , respectively. The value of linear regression coefficient, R^2 is used to determine whether the calculations are significant. A value of R^2 close to 1 indicates that the relationship is adequately described by a straight line. In this report, we will use these definitions to determine the plastic viscosity and yield stress using various rheometers.

In summary, tests that are more sophisticated than the slump test are needed to determine the workability or flow properties of concrete mixtures. Several instruments have been designed to address this problem [4]. Some of these devices rely on empirical relationships (such as the slump test), while others rely on absolute physical relationships of the fluid rheology as they apply to concrete materials. The devices designed to use

fluid rheology methods to measure the flow of concrete are called rheometers [5]. They generally measure the torque at varying rotational velocities and might or might not relate those values to shear stresses and shear rates, respectively.

Rheometers designed for polymers or neat fluids with no solid particles are not suitable for measuring the flow characteristics of concrete due to the presence and size of the aggregates. Concrete rheometers have a wide variety of designs to deal with the problem of measuring the rheological properties of a fluid containing a large volume percent of solid particles. The range of designs makes it difficult to compare the results from the rheometers on a common basis. One obvious solution would be to have a standard reference material to calibrate the rheometers. To date, no standard material has been developed to simulate fresh concrete rheological behavior. Therefore, the best alternative for comparing the instruments was to bring the rheometers to one location and conduct measurements on the same concrete mixtures.

The goal for Phase II of this project was to extend the work of Phase I by comparing the rheometer measurements on another set of concrete mixtures. Phase I of this project was conducted in France in 2000 [3]. The results of Phase I were that the rheometers ranked all the concrete in the same order, but that their absolute values of plastic viscosity and yield stress are not directly comparable. Preliminary pair wise correlation functions were developed for the rheometers present at the Phase I testing.

Concrete rheometers that are available today are:

- BML (Iceland) [6, 7]
- BTRHEOM (France) [8, 9]
- CEMAGREF-IMG coaxial rheometer (France) [1]
- IBB (Canada) [10]: two versions: lab and portable
- Two-Point (UK) [11]
- UIUC (USA) [12, 13]
- The Flow of High Performance Concrete Meter (FHPCM) [14]
- Bertta Apparatus [15]

This list might not be complete, but the authors are not aware of others rheometers at this time.

The CEMAGREF-IMG was not used in the present study because it was not possible to transport such a large rheometer (500 L capacity) to the Cleveland test site. The UIUC rheometer was not present in Cleveland due to logistic reasons, but it was used for the oil measurements that are reported here. The last two rheometers listed were not available for this study.

The IBB and Two-Point rheometers are based on rotating an impeller in fresh concrete contained within a cylindrical vessel. The shape of the impeller varies with the rheometer. The BTRHEOM and UIUC are parallel plate rheometers. The concrete is placed in a cylindrical container with a fixed bottom plate and a rotating upper plate. The CEMAGREF-IMG and the BML are coaxial cylinder rheometers in which one cylinder (inner cylinder for the CEMAGREF-IMG and outer for the BML) is rotated at controlled

speed. For all the rheometers, the standard procedure is to increase and then decrease the speed of the rotating arm (vane, top plate or inner/outer cylinder) and to measure the torque resulting from the concrete. The flow pattern of the concrete in the IBB and Two-Point rheometers cannot be easily assessed or modeled, while the flow can be mathematically modeled for the coaxial rheometers (BML, CEMAGREF-IMG) and for the parallel-plate rheometers (BTRHEOM, UIUC). For these four rheometers (BML, BTRHEOM, CEMAGREF-IMG, UIUC), rheological characteristics in fundamental units can be estimated from the mathematical model of the flow geometry. Test results for these four rheometers are reported here in fundamental units (shear stress = Pascals (Pa); viscosity = Pascal seconds (Pa·s)). The Two-Point rheometer used in this test was calibrated to convert its torque/speed raw data into fundamental units using calibrating fluids of known viscosity. The IBB rheometer can also be calibrated to convert torque/speed data into fundamental units. However, the instruments used in this test were not calibrated and therefore, the IBB results are not reported in fundamental units.

Comparison and correlation functions, which can relate the results obtained with the various rheometers, are essential to advance the science of concrete rheology and therefore provide a better characterization of concrete “workability”.

A tentative approach to developing a standard material for concrete rheometers was made using high viscosity oil. This oil can be accurately measured in a laboratory fluid rheometer and concrete rheometers could be calibrated by measuring the oil and comparing this measurement to the fluid rheometer value. This is only an approximation at best because the oil is a Newtonian fluid while most concrete is typically assumed to behave as a Bingham fluid. Also, the concrete has particulates and the oil does not. Therefore, only viscosity can be compared and not yield stress.

Under the auspices of ACI subcommittee 236A, “Workability of Fresh Concrete,” a group of researchers obtained a grant from ACI’s Concrete Research Council (CRC) to conduct a series of comparison tests on concrete rheometers. The first test was conducted on October 23-27, 2000, in the facilities of the Laboratoire Central des Ponts et Chaussées (LCPC) located in Nantes (France). An extension of the grant allowed a second series of tests to be conducted at Masters Builders in Cleveland (Ohio) USA in May 19-23, 2003.

This report summarizes the rheometers used and their operation, the concrete compositions and preparation procedure, and all the data obtained as well as some data interpretation. As in the first report, all the data are presented as measured. This will provide a valuable database for use by researchers in this field. Summaries of the different aspects of this research along with further analysis will be presented in ACI journals and other publications.

2. Concrete Mixtures

2.1. Constituents

Twenty-two mixtures (17 concrete and 5 mortar) were produced using cement and aggregate materials stocked as normal laboratory supply in Master Builder’s Cleveland Technical Center. All admixtures were commercially available products. All cementitious, aggregate and admixture materials used throughout the testing were taken from the same lots.

The cement was an ASTM Type I/II from Ashgrove Cement Company. The fly ash was a Class F ash from ISG. The dry condensed silica fume was Rheomac SF 100. A polycarboxylate-based admixture (commercial name: Glenium 3030) was used in all mixtures requiring a high-range water-reducer admixture (HRWRA). The air-entraining admixture (AEA) used in mixture D1M5Conc was Micro-Air and the viscosity-modifying admixture (VMA) used in mixtures D2M3Conc and D2M7Conc was Rheomac VMA 450.

Three different aggregate fractions were used in each concrete mixture. Only the fine aggregate fraction was used in the five mortar mixtures. The fine aggregate fraction was quarried natural sand with angular shaped grains. The two coarse aggregate fractions were different gradings of a crushed limestone material. The size distributions of the three aggregate fractions are given in Table 1. The coarse aggregate absorption was 0.6 % by mass fraction and the bulk saturated-surface-dry specific gravity was 2.78. The fine aggregate absorption was 1.79 % and the bulk saturated-surface-dry specific gravity was 2.58.

Table 1: Aggregate particle size distributions

US Standard Sieve	Mesh Size [μm]	Cumulative % Retain CoarseAgg1 #57	Cumulative % Retain CoarseAgg2 #8	Cumulative % Retain Fine Aggregate
1 in.	25000	0.1		
3/4 in.	19000	16.8		
1/2 in.	12500	74		
3/8 in	9500	84.2	9.3	
#4	4750	96.2	71.2	0.4
#8	2360	98.6	93.7	11.2
#16	1180	98.6	97.8	26.6
#30	600			46.5
#50	300			78.3
#100	150			95.8
#200	75			98.7
Pan		100	99.7	99.8

As is shown in *Figure 1*, the coarse aggregate fraction contains particles with some dimensions larger than nominal 25 mm. There was no attempt made in this test program to provide a carefully designed aggregate gradation for each concrete as was the case in the Phase I tests. The aggregate gradation used for these tests was selected first to be constant over all tests and second to be representative of common US proportioning practice. However, as described below, a decision was made during the actual testing to modify the aggregate gradation for preparation of the LoYld baseline concrete and related test mixtures. Originally it was intended to use the constant sand to total aggregate volumetric ratio (S/A) of 0.50 for all mixtures. This was changed during testing to provide a 0.55 S/A for the LoYld related test mixtures.



Figure 1: The aggregates used in the Cleveland test: Sand and gravel particles. As shown to the right, the aggregate size can be larger than 25 mm due to elongated shape.

2.2. Mixture Proportions

The objective was to prepare all test mixtures as variations of two baseline concrete mixtures. One baseline mixture (HiYld) was a conventional concrete proportioned to provide a slump of 100 mm to 150 mm. The primary objective for the HiYld baseline mixture was a uniform reproducible concrete with a slump value not less than 100 mm. The other baseline mixture (LoYld) was a self-consolidating concrete (SCC) proportioned to provide a slump flow of 550 mm to 650 mm. The primary objective for the LoYld baseline mixture was a uniform reproducible highly fluid concrete with no segregation.

Each of the baseline mixtures (HiYld and LoYld) was mixed and tested three times to provide reproducibility data. In addition, baseline mortar mixtures were prepared from each baseline concrete mixture proportion by removing the coarse aggregate fraction. The HiYld baseline mortar was prepared three times and the LoYld mortar was prepared one time.

The list of the mixtures is shown below. The name code is DXMYConc or DXMYMort where DX indicates the day of mixing (e.g. D2 = day 2), and MY indicates the mixing order on a specific day (e.g. M3 = mixture 3). *Conc* designates a concrete mixture while *Mort* designates a mortar mixture (coarse aggregate fraction omitted).

The test mixtures derived from the HiYld baseline were as follows:

<u>Mixture ID</u>	<u>Description</u>
D1M1Conc	first HiYld baseline concrete mixture
D1M1Mort	first HiYld baseline mortar mixture
D1M2Conc	second HiYld baseline concrete mixture
D1M2Mort	second HiYld baseline mortar mixture
D1M3Conc	HiYld baseline concrete mixture VARIATION add water
D1M4Conc	HiYld baseline concrete mixture VARIATION add HRWRA
D1M5Conc	HiYld baseline concrete mixture VARIATION add AEA
D2M1Conc	third HiYld baseline concrete mixture
D2M1Mort	third HiYld baseline mortar mixture
D3M4Conc	HiYld baseline concrete mixture VARIATION add fly ash

The test mixtures using the LoYld baseline were as follows:

<u>Mixture ID</u>	<u>Description</u>
D2M4Conc	first LoYld baseline concrete mixture
D2M5Conc	second LoYld baseline concrete mixture
D2M6Mort	correct LoYld baseline mortar
D2M7Conc	LoYld baseline concrete mixture VARIATION add VMA
D3M2Conc	LoYld baseline concrete mixture VARIATION add fly ash
D3M3Conc	LoYld baseline concrete mixture VARIATION add silica fume (1)
D3M5Conc	third LoYld baseline concrete mixture
D3M6Conc	LoYld baseline concrete mixture VARIATION add silica fume (2)

An additional three concrete mixtures and one mortar were prepared that did not use either the HiYld or LoYld baseline mixture proportions.

- D2M5Mort was to be the baseline mortar mixture for D2M5Conc however the HRWRA was incorrectly dosed. The mixture was completely measured and retained to provide an additional data point.
- D2M2Conc was the initially planned mixture proportions for the LoYld baseline. This concrete was judged to be too close to segregation to be used as the baseline mixture for the LoYld mixture series. The mixture proportions were changed to decrease the water-cementitious materials ratio (w/cm) and increase the sand-total aggregate ratio (S/A). These revised LoYld baseline mixture proportions were tested as D2M4Conc and selected as the LoYld baseline mixture listed above.
- D2M3Conc was the same mixture proportions as D2M2Conc but with addition of VMA.
- D3M1Conc was an additional concrete mixture prepared with the same w/cm as the LoYld baseline but with increased S/A.

Table 2 to Table 4 show the mixture proportions and laboratory measurements for each mixture in order as prepared for each test day. Note that the dosage of the admixtures was calculated on the basis of mass of active admixture solids to mass of the cement only even if supplementary cementitious materials were present.

Table 2: Mixture proportions and measurements for Day 1 mixtures. See section 2.4 for the measurements details.

Mixture ID	D1M1 Conc	D1M1 Mort	D1M2 Conc	D1M2 Mort	D1M3 Conc	D1M4 Conc	D1M5 Conc
Mixture design	kg/m ³	kg/m ³	kg/m ³	kg/m ³	kg/m ³	kg/m ³	kg/m ³
Cement	413	613	407	614	416	402	389
Silica Fume	0	0	0	0	0	0	0
Fly Ash	0	0	0	0	0	0	0
Fine Agg. (SSD)	869	1292	857	1294	834	846	819
Coarse Agg1 (SSD) (#57)	608	0	599	0	584	573	573
Coarse Agg2 (SDD) (#8)	327	0	323	0	314	318	308
Total Water	186	276	183	276	197	180	175

w/cm	0.45	0.45	0.45	0.45	0.47	0.45	0.45
S/A	0.50	1.00	0.50	1.00	0.50	0.50	0.50
Coarse Agg. Vol. Fraction [%]	54.7	0.0	54.7	0.0	52.6	53.6	54.7

Admixtures

HRWRA (% by mass fract cement)						0.04	
VMA (% by mass fract. of cement)							
AEA (% by mass fract. of cement)							0.005

Measurements

Δt (min)	19	15	9	14	12	33	10
Density (kg/m ³)	2402	2179	2371	2185	2345	2339	2262
Gravimetric Air (%)	1.0	3.0	2.4	2.7	2.6	3.7	6.8
Pressure Air (%)	1.6	1.4	1.4	0.9	0.9	2.6	6.1
Concrete Temperature (°C)	24	24	24	24	24	24	24
Slump (mm)	152		127	248	210	210	133
Slump Flow (mm)				483			
U-box Rise Ht (mm)	184	375	235	387	394	260	216
V-funnel Time (s)		2.0		1.9	4.0	6.5	

Note: The value of Δt for each mixture was the elapsed time in minutes from the contact of water and cement until the start of all measurement procedures.

Table 3: Mixture proportions and measurements for Day 2 mixtures. See section 2.4 for the measurements details.

Mixture ID	D2M1	D2M1	D2M2	D2M3	D2M4	D2M5	D2M5	D2M6	D2M7
	Conc	Mort	Conc	Conc	Conc	Conc	Mort	Mort	Conc
Mixture Design	kg/m ³	kg/m ³	kg/m ³	kg/m ³	kg/m ³	kg/m ³	kg/m ³	kg/m ³	kg/m ³
Cement	412	625	438	443	480	478	686	691	492
Silica Fume	0	0	0	0	0	0	0	0	0
Fly Ash	0	0	0	0	0	0	0	0	0
Fine Agg. (SSD)	868	1316	851	883	926	922	1322	1331	949
Coarse Agg1 (SSD) (#57)	606	0	596	618	530	528	0	0	543
Coarse Agg2 (SDD) (#8)	326	0	321	333	285	284	0	0	292
Total Water	185	281	175	160	166	165	237	238	170
w/cm	0.45	0.45	0.40	0.36	0.35	0.35	0.35	0.35	0.35
S/A	0.50	1.00	0.50	0.50	0.55	0.55	1.00	1.00	0.55
Coarse Agg. Vol. Fraction [%]	54.7	0.0	54.5	56.6	46.1	46.1	0.0	0.0	46.0

Admixtures

HRWRA (% by mass fract cement)			0.13	0.26	0.2	0.2	0.13	0.2	0.25
VMA (% by mass fract. of cement)				0.02					0.02
AEA (% by mass fract. of cement)									

Measurements

Δt (min)	14	16	44	26	26	15	17	19	18
Density (kg/m ³)	2396	2224	2383	2434	2383	2377	2243	2262	2447
Gravimetric Air (%)	1.3	1.0	2.6	1.7	3.2	3.4	3.4	2.6	0.6
Pressure Air (%)	1.3	1.2	1.9	0.9	3.2	3.2	4.0	1.6	0.6
Concrete Temperature (°C)	24	24	24	23	23	23	23	23	23
Slump (mm)	121	241							
Slump Flow (mm)		457	660	641	635	533	444	787	610
T50 (s)			2.0	4.7	2.3	4.7			2.8
U-box Rise Ht (mm)	184	343	349	362	356	349	324	362	349
V-funnel Time (s)		2.3	2.9	9.2	5.8	7.3	3.1	1.9	8.9

Note: The value of Δt for each mixture was the elapsed time in minutes from the contact of water and cement until the start of all measurement procedures.

Table 4: Mixture proportions and measurements for Day 3 mixtures. See section 2.4 for the measurements details.

Mixture ID	D3M1	D3M2	D3M3	D3M4	D3M5	D3M6
	Conc	Conc	Conc	Conc	Conc	Conc
Mixture Design	kg/m ³	kg/m ³	kg/m ³	kg/m ³	kg/m ³	kg/m ³
Cement	479	367	428	320	481	450
Silica Fume	0	0	37	0	0	18
Fly Ash	0	92	0	80	0	0
Fine Agg. (SSD)	1097	940	917	882	927	920
Coarse Agg1 (SSD) (#57)	387	538	524	616	531	527
Coarse Agg2 (SDD) (#8)	208	289	282	332	285	283
Total Water	166	168	164	188	166	165

w/cm	0.35	0.37	0.35	0.47	0.35	0.35
S/A	0.67	0.55	0.55	0.50	0.55	0.55
Coarse Agg. Vol. Fraction [%]	30.7	45.8	45.9	54.3	46.1	46.1

Admixtures

HRWRA (% by mass fract cement)	0.2	0.22	0.22		0.2	0.21
VMA (% by mass fract. of cement)						
AEA (% by mass fract. of cement)						

Measurements

Δt (min)	16	24	11	12	11	11
Density (kg/m ³)	2337	2396	2350	2416	2389	2363
Gravimetric Air (%)	4.3	1.5	3.9	0.0	2.9	3.6
Pressure Air (%)	4.0	1.1	4.2	0.9	2.2	4.3
Concrete Temperature (°C)	23	23	23	23	23	23
Slump (mm)	222		222	203		241
Slump Flow (mm)	356	622	356	356	597	406
T50 (s)		1.4			2.2	
U-box Rise Ht (mm)	292	362	305	292	349	311
V-funnel Time (s)	6.4	2.4	8.4	3.2	5.2	7.8

Note: The value of Δt for each mixture was the elapsed time in minutes from the contact of water and cement until the start of all measurement procedures.

2.3. Mixture Production

All mixtures prepared over the three days of testing were mixed in the same rotating drum mixer (capacity 170 L). The same mixing procedure was followed for all concrete mixtures. The mixer was charged with approximately three-quarters of the mixing water, and all the coarse aggregate, cement and sand. The mixer and time clock were started. The remaining mixing water was added within the first minute of mixing. Mixing was continued at a constant 2.09 rad/s (20 rpm) drum rotation rate for a total of 5 min. After 5 min mixing, the concrete was discharged into two wheelbarrows and moved closer to the various rheometers located throughout the laboratory. Each rheometer crew transferred concrete using hand scoops to fill the rheometer from the wheelbarrows and signaled their readiness to start. When all groups were ready a start-command was given and all testing started at the same time.

The mixing procedure was changed for the mortar mixtures. All cement and sand were charged and the mixer was started. After approximately 30 s to 60 s of dry mixing, the clock was started and the mixing water was gradually added with the mixer turning. Total mixing time from addition of first water was 5 min. The mixer was discharged into wheelbarrows and from there followed the same sequence as the concrete mixtures.

Addition of admixtures was varied according to admixture type. Air-entraining admixture for D1M5Conc was added at the start of mixing. Viscosity-modifying admixture for D2M3Conc and D2M7Conc was added after 2 min of mixing. HRWRA for all mixtures was added with approximately 80 % of total dosage in the initial charge water and the remainder added to the mixture before completion of 2 min of mixing.

2.4. Mixture Measurements

Each concrete or mortar mixture prepared during the three test days was measured using some or all of the following methods in addition to the measurements made by the concrete rheometers. These measurements are recorded in the measurements section of Table 2 to Table 4. Each concrete rheometer was used to determine the yield stress and plastic viscosity characteristics of each concrete and mortar mixture using the Bingham relationship. The results of these tests are presented in Chapter 5.

The value of Δt for each mixture was the elapsed time in minutes from the contact of water and cement until the start of all measurement procedures. Gravimetric air content and density were determined for all mixtures according to ASTM C 138. Pressure air content was determined for all mixtures according to ASTM C 231. Temperature for each mixture was measured using the same thermometer inserted into the concrete in one of the distribution wheelbarrows.

Slump and/or slump flow measurements were made on each mixture. Slump was measured according to ASTM C 143 with the measurement frustrum centered on a smooth, level polymer surface. Slump flow was measured as the average of the maximum

and minimum diameters of the pile remaining after making the standard slump measurement.

Mixtures were measured for rising height (*UboxRiseHt*) using a stainless steel U-box having internal dimensions as shown in Figure 2. The dimension of the U-box in this study is identical to those used by PCI [16] and JSCE [17]. V-funnel times (*V-funnel Time*) were measured for all mixtures with slump greater than 200 mm. The V-funnel used was a stainless steel apparatus having internal dimensions as shown in Figure 3.

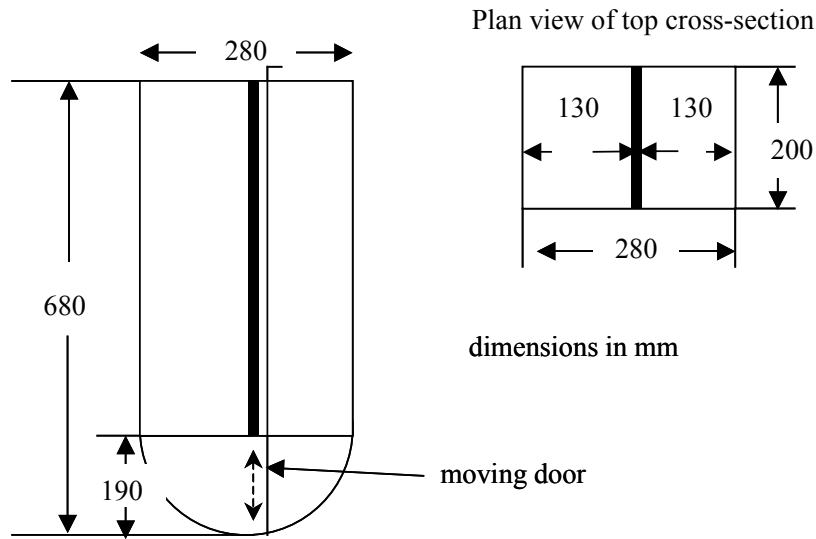

Figure 2: U-Box schematic and dimensions

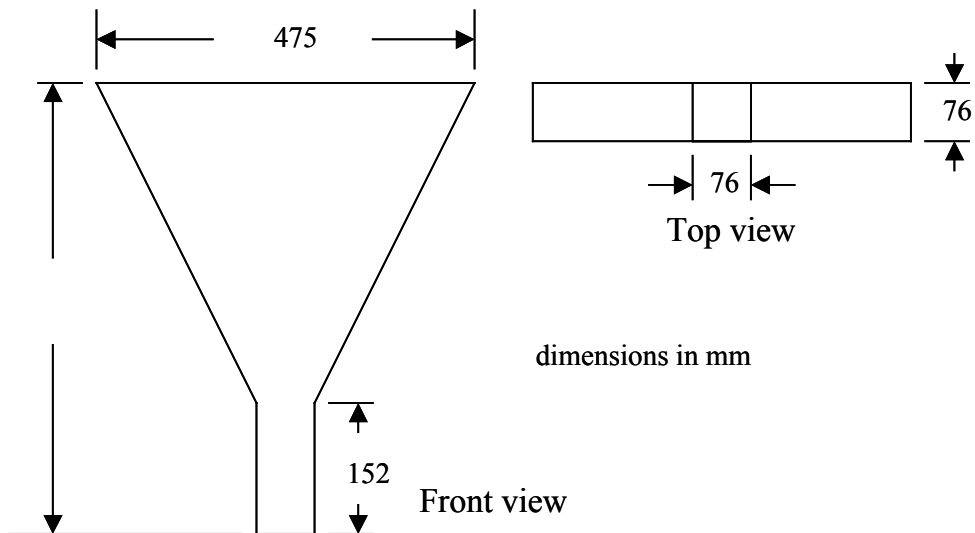

Figure 3: V-Funnel schematic and dimensions

3. Concrete Rheometers

3.1. The BML Rheometer

3.1.1. Description of the apparatus

The ConTec BML Viscometer 3, used in this test, is a coaxial cylinder viscometer for coarse particle suspensions. It is based on the Couette viscometer [18] principle where the inner cylinder measures torque as the outer cylinder rotates at variable angular velocity. It was developed in Norway in 1987 [19, 20] after six years of intensive work with the Tattersall Two-point test instrument. For the tests described in this report, the ConTec BML Viscometer 3 was used (Figure 4). To simplify the text, this instrument will be referred simply as BML in the rest of this report.

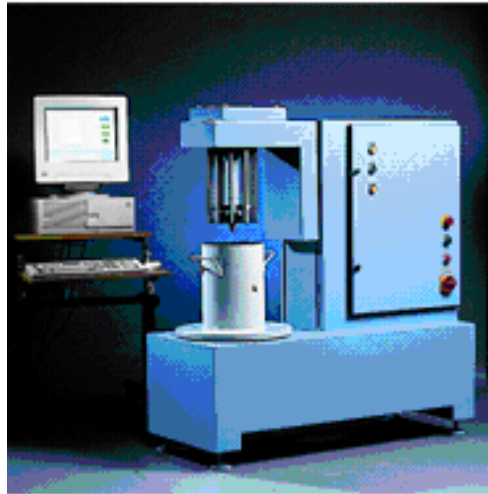

Figure 4. The ConTec BML Viscometer

The instrument is fully automated and is controlled by computer software called FreshWin. Each test takes about 3 min to 5 min, from filling the bowl/material container to emptying it. During testing, the material is exposed to shear for about one minute (depending of the software set-up used). A trolley is used for transporting the container (outer cylinder) full of concrete for easy operation.

Several measuring systems can be used depending on the maximum aggregate size in the suspension to be tested. Details are given in Ref. [3]. Each measuring system is related to the diameter of the inner cylinder. The C-200 measuring system was used in the comparison tests in both rheometer comparison tests held in Nantes [3] and the present test series. This system assumes that the maximum aggregate size is 16 mm. In the Cleveland test, it was about 25 mm, which is higher than assumed for the current geometry.

The parameters for each measuring system are incorporated as a standard set-up in the FreshWin software. Details of the measurements are given in Ref. [3].

Figure 5 shows the inner and outer cylinder. Both cylinders contain ribs parallel to their axis. Therefore, it is the material tested that will form the actual inner and outer cylinder. This leads to a larger cohesion (or stickiness) between the cylinders and the test material, hence reducing the danger of slippage.

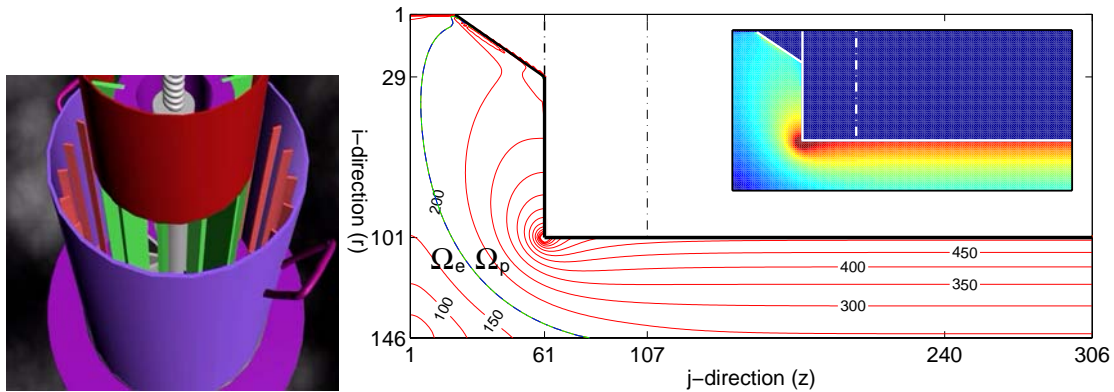

Figure 5 : *To the left: The inner and outer cylinder of the BML. To the right: The computed shear stress τ (in Pa) for the C-200 system [21]. $\tau_o = 200$ Pa, $\mu = 20$ Pa·s, $N = 0.076$ rad/s (0.48 rps).*

The inner cylinder consists of three parts; the upper unit (measuring unit), the lower unit and the top-ring (Figure 5). It is only the upper unit that measures torque. The lower unit is to eliminate or minimize the so-called bottom effects. In this way it is insured that only two-dimensional shearing of the test material generates torque, which the instrument records. The functionality of the top ring is somewhat less important. Its main function is to keep a constant height h where torque is measured. This is done to simplify the calculations of the plastic viscosity μ and the yield value τ_o . If omitted, then the height has to be measured for each test and put manually in the Fresh Win software.

As shown in Figure 5, at the bottom of the coaxial cylinder viscometer a complex three-dimensional shearing occurs in the material. In this bottom zone, the shear rate is not uniform for the given angular velocity. In addition, the material may not have reached equilibrium shear stress for the given angular velocity, although it has done so at the upper zone where the pre-mentioned two-dimensional shearing exists.

3.1.2. Analysis of data

As for all of the rheometers used in this test program, the results are interpreted using the Bingham model. A three-dimensional and a top view of the coaxial cylinders viscometer are shown in Figure 6. The outer cylinder (with radius r_o) rotates at rotational frequency N , while the inner cylinder (with radius r_i) is stationary and registers the applied torque T from the test material (i.e. from the cement-based material). The term h is the height of

the inner cylinder. Equation (2) relates H and G to μ and the yield value τ_o of the tested material. Further description about this equation can for example be found in [3].

$$T = \frac{4\pi\mu h}{\left(\frac{1}{r_i^2} - \frac{1}{r_o^2}\right)} \Omega + \frac{4\pi\tau_o h}{\left(\frac{1}{r_i^2} - \frac{1}{r_o^2}\right)} \ln\left(\frac{r_o}{r_i}\right) = H\Omega + G \quad [2]$$

Further details and discussion on this instrument could be found in ref. [18, 21, 22, 3].

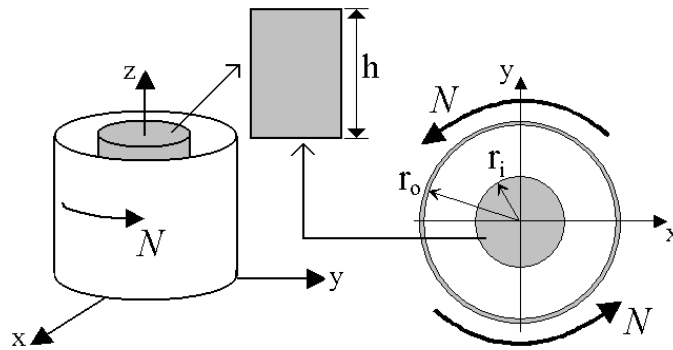

Figure 6: A three-dimensional- and a top view of the coaxial cylinder viscometer.

Calibration of the torque and the angular velocity is done by external load cell and stopwatch (or light-tacho meter). The measured values are inserted into the FreshWin software, which calculates the calibration constants. To confirm that the calibration is correct one can test commercial products with known or stable rheological properties, like the oil, CylEso 1000. Figure 7 shows theoretical line and measured kinematic viscosity with the BML Viscometer (Borregaard & Euroc Res.) and values measured with a tube viscometer by the oil-testing laboratory Fjölver. The results show good correlation and indicate that the BML Viscometer (due to the high accuracy of the instrument) can also be used to measure the viscosity of such a fluid liquid as the CylEso 1000.

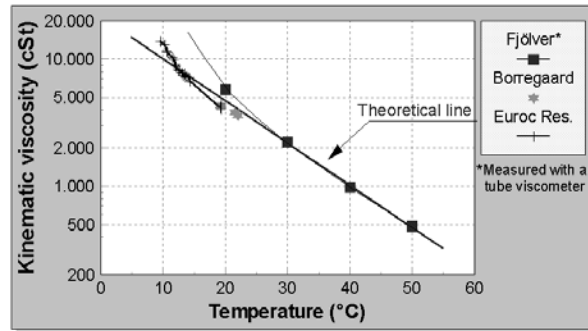

Figure 7: Kinematic viscosity of CylEso 1000 measured with tube viscometer (oil testing laboratory Fjölver) and the BML.

3.2. BTRHEOM Rheometer

3.2.1. Description of the apparatus

The BTRHEOM rheometer (Figure 8) is a parallel plate rheometer capable of measuring the flow properties of moderately to highly fluid concrete mixtures; namely, those with slumps greater than approximately 100 mm (4 in). The device consists of a 240 mm diameter cylindrical container with two parallel blades mounted at the top and bottom of the container a vertical distance of 100 mm apart. The bottom blade remains stationary as the top blade rotates, resulting in the application of shear stress to the concrete specimen. The motor is housed below the container and is connected to the top blade through a 40 mm diameter shaft that extends through the center of the container. The resultant torque from the top blade is measured as this top blade is rotated at a series of different rotation speeds. The device includes a vibrator to consolidate the concrete and to measure the effect of vibration on rheological parameters.

An accompanying software program, ADRHEO, operates the device, records data, and computes the rheological parameters. The text output file includes the computed rheological parameters and the values of torque for each rotation speed. Different versions of ADRHEO are available to either calculate the Bingham parameters or the Herschel-Bulkley parameters.

A more complete description of the device, including details on the derivation of the Bingham parameters and the Herschel-Bulkley parameters, is available in the report from the previous comparison of concrete rheometers [3]. Additional information on the development and implementation of the device is available in Refs. [23], [24], and [25].

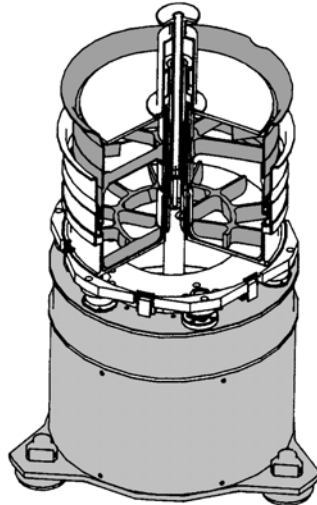

Figure 8: The BTRHEOM rheometer showing the blades at the top and bottom of the bucket containing the concrete [8].

3.2.2. Test procedure

Prior to initial testing, the BTRHEOM rheometer was calibrated for torque, rotational velocity, and vibration frequency as per the manufacturers' specifications. Before each test, further refinement of calibration was completed by performing a rotational calibration test. Two seals, used to prevent concrete from penetrating into the area between the bucket and rotating cylinder, were carefully fitted to the apparatus before each mixture was tested. To account for the frictional resistance of each set of seals, a rheology test was completed with water. The results are used by the ADRHEO software to account for the mean friction effects of the seals for the following test with concrete or mortar mixtures.

The procedures used for testing were developed to closely mimic those used in the pilot study in Nantes, France [3]. A description of the general procedures is given. Notes attached to individual mixtures in Appendix A are provided where protocol differed. As the concrete or mortar was added to the rheometer, the bucket was shaken and the concrete was rodded as needed to ensure proper filling of the container. High yield stress (HiYld series) concrete mixtures were pre-vibrated for 15 s at 36 Hz to ensure proper consolidation. No pre-vibration was used for low yield stress (LoYld series) concrete mixtures and mortar mixtures. As the tests are performed using the BTRHEOM rheometer, the ADRHEO software plots the measured torque for the specified varying rotational velocities after the velocity and reading are stabilized (about 20 s). The tests consisted of two consecutive down ramps (i.e. decreasing the rotational velocity during the test) with seven points per ramp and angular velocities ranging from 1.2 rad/s to 0.015 rad/s (0.8 rev/s to 0.1 rev/s). Only the set of results from the first down ramp are used in the analysis for this study. It is noted that the second series of data points typically yielded a lower yield stress and similar viscosity when compared to the first series. The second set of data was obtained for possible future study. It was realized during the testing that the BTRHEOM lacked capabilities to sufficiently move the concrete at 0.015 rad/s (0.1 rev/sec) so the analysis was completed for all the mixtures without that data point. Although some highly fluid concrete and mortar mixtures did result in reasonable torque values at the low angular velocity (0.015 rad/s or 0.1 rev/s), the data point was excluded in all mixtures for consistency and to eliminate the possibility of using any improper outliers points for analysis.

3.2.3. Analysis of the data

Torque versus rotational velocity data is collected with the ADRHEO software. Although the focus of this study is to obtain the Bingham parameters, the ADRHEO software has capabilities to report the Hershel-Buckley parameters as well. A straight line with an intercept (G) in $\text{N}\cdot\text{m}$ and slope (H) in $\text{N}\cdot\text{m}\cdot\text{s}$ is characteristic of the torque ($\text{N}\cdot\text{m}$) versus rotational velocity (rad/s or rev/s) data for Bingham fluids. Refer to [1] for a description of the methods to convert the intercept (G) and slope (H) to shear stress and viscosity respectively. The multipliers to convert G to yield stress and H to plastic viscosity are 277.596 Pa/ $\text{N}\cdot\text{m}$ and 44.01 Pa·s/ $\text{N}\cdot\text{m}\cdot\text{s}$ for this set-up, respectively.

The regression analysis and mean friction values for the seal tests were computed and outputted from the ADRHEO software. The mean friction values were used inherently as a point of reference for the subsequent concrete and mortar tests. Although the program has capabilities to complete the regression analysis and report shear stress and viscosity values, the MS Excel computer program was used to analyze the raw test data for the concrete and mortar mixtures. This was necessary because of the outliers data points described above (at the low rotational velocities). In addition, the program will report regression values for the Herschel-Buckley model if it produces a better fit than the Bingham model; the focus of this project was to study the Bingham parameters.

3.3. The IBB Rheometer

3.3.1. Description of the apparatus

This apparatus is an instrumented and automated version of the existing apparatus (MKIII) developed by Tattersall [26]. It was modified in Canada by Beaupré [27] to study the behavior of high performance wet-process shotcrete. The apparatus is fully automated and uses a data acquisition system to drive an impeller rotating in fresh concrete. The test parameters are easy to modify in order to produce any required test sequence. The analysis of the results is also automated and the parameters, G (in Nm) and H (in $N \cdot m \cdot s$), related to the Bingham parameters, the yield stress and plastic viscosity, are displayed on the screen. The user may also retrieve the individual data sets to plot the flow curves manually.

This apparatus can be used to test concrete with slumps ranging from 40 mm to 300 mm. It has been successfully used for self-compacting concrete, high-performance concrete, pumped concrete, dry and wet-process shotcrete, fiber reinforced concrete and normal concrete. It has also been used on a few job sites as a means of quality control. The general view of the apparatus is shown in Figure 9. The impeller shape and the planetary motion are as developed for the Tattersall MKIII (LM) apparatus. The concrete bowl leaves a 50 mm gap between the impeller and the bowl. The recommended maximum size aggregate is 25 mm. The sample size is 21 L.



Figure 9: Picture of IBB Rheometer

The IBB Portable rheometer (Figure 10) is a traditional IBB rheometer transformed to be portable and be used on construction sites. The only difference is the frame. The control

system, the planetary motion, impeller and bowl dimension are exactly the same as the non-portable. On construction sites, it is powered by a portable gas generator.



Figure 10: Picture of portable IBB Rheometer (a) in the lab and (b) on a construction site

3.3.2. Analysis of the data

The IBB rheometer is fully automated and the results are displayed automatically after a test is conducted. Different test sequences can be entered into the computer. The stored measured data of impeller speed and measured torque that are used to calculate G and H, are displayed on the control unit screen. The software provided with the IBB rheometer calculates the following parameters from the torque/speed data: H, G, M, B and R^2 . Figure 11 shows the definitions of these parameters. H and G could be related to plastic viscosity and yield stress, respectively. The first point and the points for which the speed is 0 are not used in the calculations.

Two sequences were used to conduct the tests during the Cleveland comparison tests: the normal sequence and the SCC sequence. The first test is normally used for regular concrete; the maximum impeller speed reached is about 0.15 rad/s (1 rev/s). The second test used for SCC uses a lower maximum impeller speed of about 0.95 rad/s (0.6 rev/s) to minimize the risk of segregation.

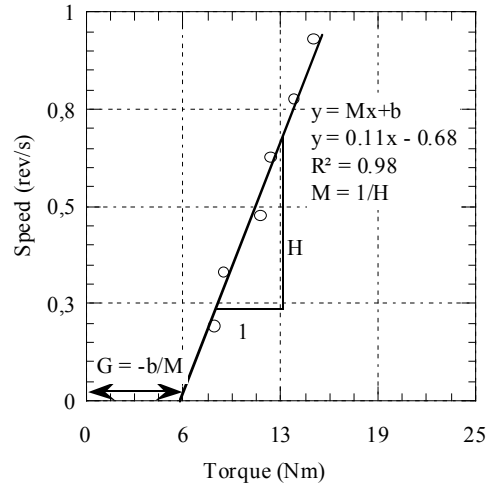
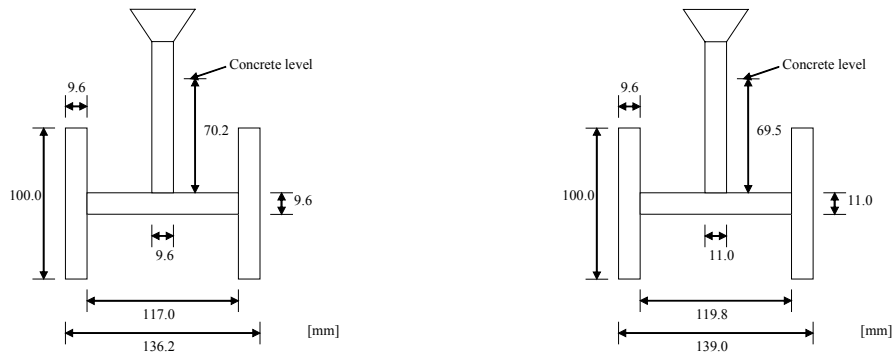

Figure 11 - IBB Calculation Example. The range of speed are 0 rad/s to 0.15 rad/s

3.3.2.1. Differences in H impeller

During the MB tests, a small difference between the two H impellers was noticed. The Figure 12 shows the exact measurements for the two impellers. The surface area is related to the induced torque and should lead to a small difference in the measured yield stress and plastic viscosity.

The H impeller area is 3717.1 mm² for the IBB and 4002.3 mm² for the IBB portable - a difference of 7 %



a)

b)

Figure 12 -a) dimensions for the IBB H impeller; b) dimensions for the IBB portable H impeller

3.4. The Two-Point Rheometer

3.4.1. Description of the apparatus

The Two-point workability test was identical to that used in the first comparative test program at LCPC Nantes [3]. It is based on the apparatus first described by Tattersall and Bloomer [28], with updating of instrumentation, data recording and analysis procedures. It is fully described in Domone, Xu and Banfill [29].

The principle is that an impeller which imparts a stirring action is rotated in a bowl of concrete, and driving torque (T) is measured. As stated in the Introduction (section 1), G and H are calculated from the measurements. Calibration of this instrument with fluids of known properties has determined the relationships between G and τ_0 , and H and μ , and hence τ_0 and μ in fundamental units can be obtained.

Two impeller systems are available:

- An axial impeller with four angled blades set in a helical pattern around a central shaft, which imparts both a stirring and mixing action to the concrete (the MH system). Only the MH system was used for this report
- An offset H-impeller with a planetary motion through the concrete (the LM system)

The former, which is suitable for concrete with slump values in excess of about 100 mm, was used in the current program. Dimensions of the impeller and bowl are given in Figure 13.

3.4.2. Test procedure

The impeller is driven by a variable speed hydraulic drive unit motor through a gearbox; the overall arrangement is shown in Figure 14. Torque is measured indirectly through the oil pressure in the drive unit, with the relationship between the oil pressure and torque obtained by prior calibration with a plunger block, radius arm and spring balance system fully described elsewhere [18].

During testing, the oil pressure can be observed on a pressure gauge, or captured digitally on a PC via a pressure transducer fitted to a tapping in the drive unit casing. The impeller speed is similarly captured from a tachometer fitted to the drive shaft. Speed is controlled manually.

The torque/impeller speed relationship was obtained in a single downward sweep of the speed from 0.15 rad/s to 0.015 rad/s (1 rev/s to 0.1 rev/s) in about 30 s. A guide trace on the PC screen was used to ensure consistency between tests. The voltages corresponding to speed and pressure were recorded four times per second, giving approximately 120 data points per test. As well as testing with the impeller rotating in the concrete, it is necessary to record the oil pressure with the impeller rotating in air (called the idling test)

over a similar speed range. The net pressure between the idling and concrete test then gives the torque needed to rotate the impeller in the concrete.

The calibration to determine the relationships needed to convert G and H to τ_0 and μ was carried out using a high viscosity silicone, a Newtonian fluid, and aqueous solutions of carboxy methyl cellulose, power law fluids. The calibration theory is described in full in Chapter 7 of Ref. [18], and the principles were summarized in the report of the first comparative test program [3].

The resulting relationships are

$$\tau_0 = 122 * g; \quad \mu = 17.24 * h \quad [3]$$

The units are:

τ_0 is in Pa while g is Nm and the constant is in Pa/N·m
 μ is in Pa·s while h is in Nm.s and the constant is in Pa·s/N·m·s

The test procedure for a measurement was as follows.

- The machine was run with the impeller rotating for at least half an hour before testing to allow the oil to reach equilibrium temperature.
- An idling test was carried out
- The concrete was loaded into the bowl with the impeller rotating at about 0.031 rad/s (0.2 rev/s) until the impeller blades were completely immersed in concrete
- The speed was increased to 0.15 rad/s (1 rev/s), and the data recording is then started and continued while reducing the speed to zero over about 30 s.
- The impeller was disconnected and the idling test repeated.

3.4.3. Analysis of the data

The data in the form of voltages proportional to speed and torque were recorded directly into an Excel spreadsheet. After discarding the tail of data at either end of the test, the following procedure was used for the concrete test data to eliminate the falsely high pressure kicks that can arise from aggregate particles trapping and interlocking:

- A best fit relationship between pressure and speed was obtained by linear regression
- The standard deviation of the residuals between the measured and predicted values was calculated
- Data points that were more than twice the standard deviation from the predicted value, were substituted by the predicted value and a second 'corrected' regression line obtained.

In practice, this increases the correlation coefficient of the regression line, but does not significantly alter the slope and intercept.

The slope and intercept were also obtained for each of the two idling tests and averaged. The two regression equations were then converted from voltages to oil pressure and impeller speed and the net pressure/speed relationship (equation 1) obtained by

subtraction. The resulting values of G and H were converted into yield stress and plastic viscosity using equations (3).

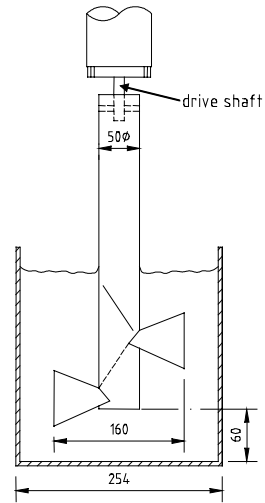

Figure 13: Impeller and bowl dimensions (in mm) of the Two-point test

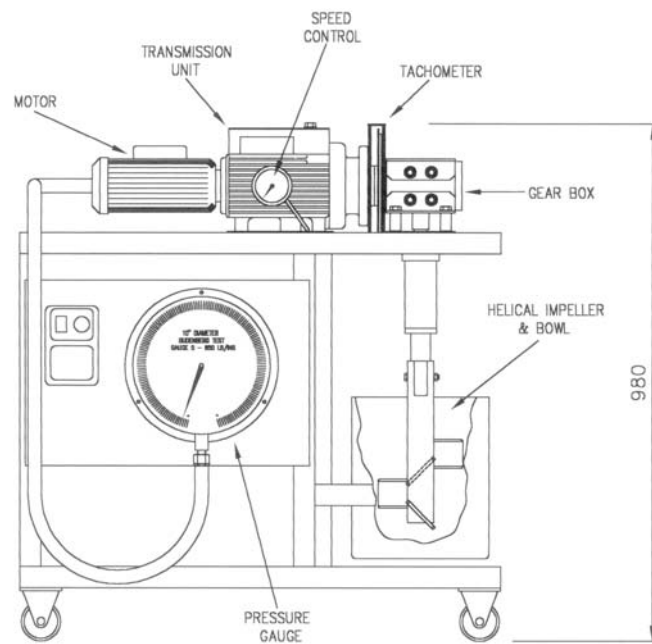

Figure 14: General arrangement of the two-point test

3.5. UIUC Rheometer (Used only for Oil Tests)

3.5.1. Description of the apparatus

This rheometer could not be transported to Cleveland for logistic reasons. Nevertheless, as oil could be shipped to UIUC, oil tests were performed. The UIUC concrete rheometer (Figure 15) was built in the machine shop at the University of Illinois at Urbana-Champaign (UIUC) [12] by modifying the frame of the Two-point Test.

The design of this rheometer was based on the BTHREOM, with major changes to reduce the difficulties involved in the installation and cleaning of the apparatus during the experiments. It can be idealized as a pseudo parallel-plate rheometer with additional sidewalls. The radius of the rotating plate is about 120 mm and the gap between two shear plates is about 90 mm. The rotational speed of the rheometer is measured by a calibrated light sensor and digital counter. The torque imposed on the rheometer is measured by a rotatory torque transducer. A PMac 2000 digital data acquisition device, manufactured by Sensor Developments Inc., was utilized to collect readings from the torque transducer and transfer the readings to a personal computer for further processing.

Adjustments were made to the rheometer to reduce errors in the measurement. The adjustment prevents sample from entering the gap between lower plate and the side wall, which otherwise will produce extra torque and make the estimation of shear stress more difficult. The adjustment is shown in Figure 16. The radius of rheometer after the adjustment is about 110 mm.

3.5.2. Test procedures

The test procedures are described as follows:

1. Before adding the oil into the rheometer, the rheometer ran empty to record the torque induced by rheometer itself. The PMac data acquisition device was set-up to work at 50 Hz, which means 50 readings were taken per second. At 2.09 rad/s, 3.14 rad/s, 4.18 rad/s, 5.23 rad/s and 6.28 rad/s (20, 30, 40, 50, and 60 rpm), the torque was measured for 10 s. The average of the readings at a certain rotational speed was used as the frictional torque T' at that speed.
2. The oil was poured into the rheometer to the level of the upper vane. The rheometer ran at 2.09 rad/s (20 rpm) for 1 min before measurements were taken. Torque was then measured for 10 s each at 2.09 rad/s, 3.14 rad/s, 4.18 rad/s, 5.23 rad/s and 6.28 rad/s (20, 30, 40, 50, and 60 rpm). Then torque was measured for 10 s each at 6.28 rad/s, 5.23 rad/s, 4.18 rad/s, 3.14 rad/s and 2.09 rad/s (60, 50, 40, 30, and 20 rpm). The average of the readings (acceleration and deceleration processes) at each rotational speed was used as the torque (T_0) at that speed.
3. The torque, T , at certain speed was calculated as $T = T_0 - T'$
4. The equations to convert torque and rotational speed to shear stress and shear rate are [12, 13]:

$$\Omega = \frac{2\pi N}{60}$$

$$\dot{\gamma} = \frac{R\Omega}{h}$$

$$\tau = \frac{1}{2\pi R^3} \left(3T + \Omega \frac{dT}{d\Omega} \right)$$

where

Ω = Angularity speed (rad/s),

N = rotational speed (rpm),

$\dot{\gamma}$ = strain rate (1/s),

R = radius of rheometer (0.12 m),

h = distance between two plates (0.11 m),

τ = shear stress (Pa),

T = torque (N·m),

$dT/d\Omega$ = Bingham model slope of Ω - T curve.

The reproducibility of rheological measurements was checked previously using marble concrete, i.e., concrete with coarse aggregate being glass spheres. The results are shown in Figure 17. It is found that the deviation of the data is acceptable and the reproducibility is good.

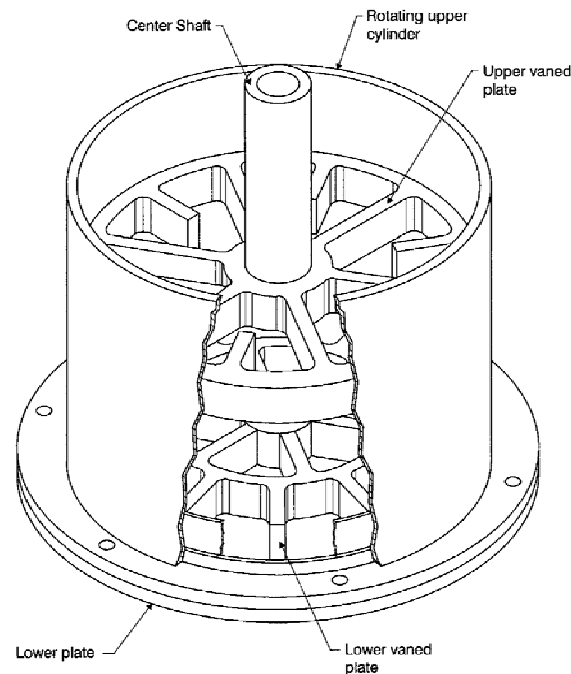
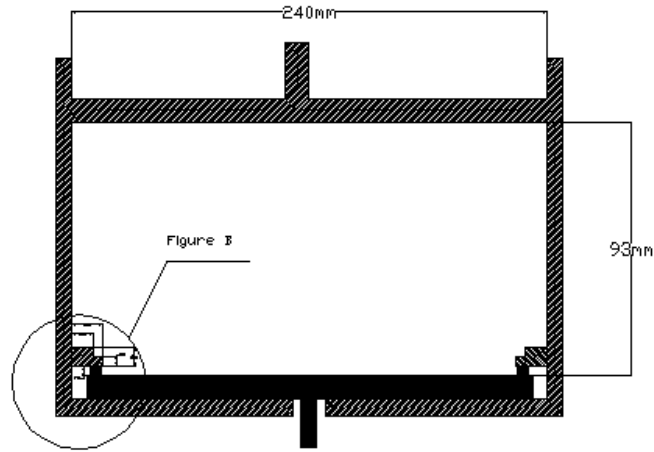
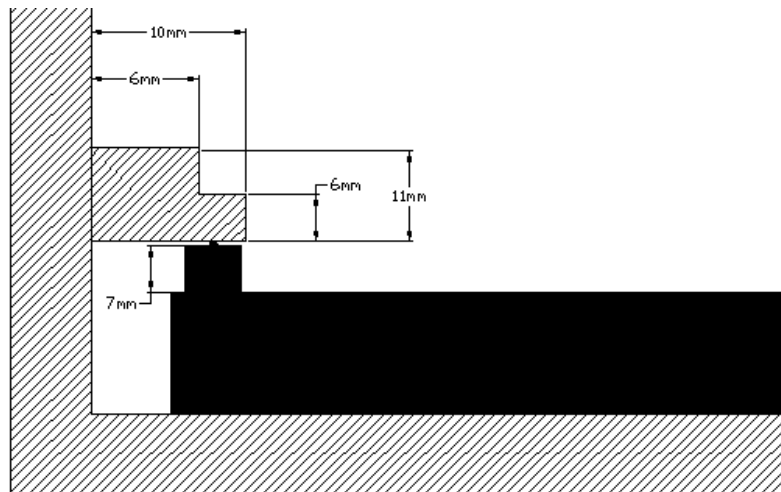

Figure 15. Parallel-plate concrete rheometer at UIUC.



A



B

Figure 16: Sketch of UIUC rheometer (A) and detailed dimensions of the rheometer (B)

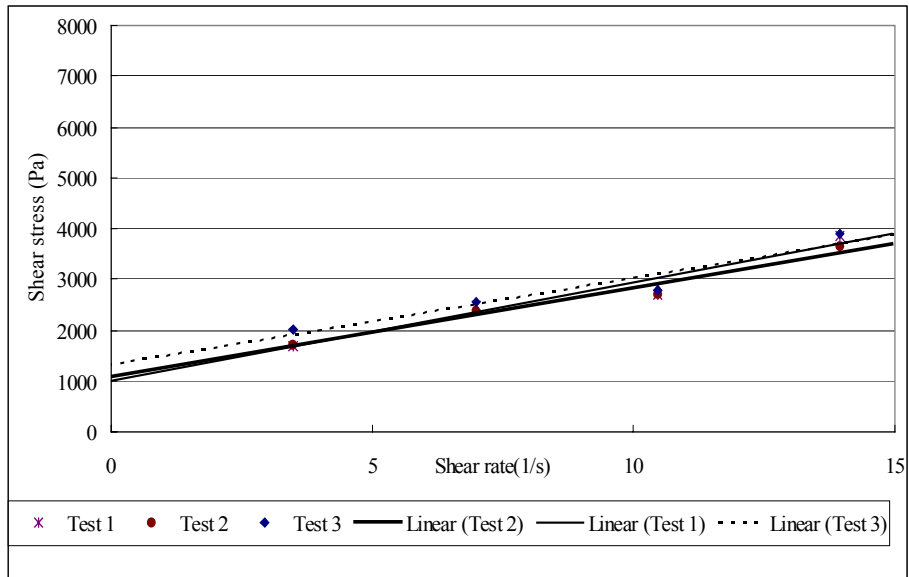

Figure 17: Reproducibility of rheological measurements using the UIUC rheometer

4. Measurements Using Oil

4.1. Materials and Procedure

To begin assessing if a reference material could be developed, oil was measured in all concrete rheometers as the last measurement on Day 3 and at a later date for the UIUC rheometer. NIST also measured the oil using a parallel plate rheometer designed and calibrated for fluids. Each concrete rheometer was filled with Dow Corning 200(R) Fluid, 30,000 CST. This material is a high viscosity fluid polydimethylsiloxane. The nominal viscosity according to the manufacturer is 29.1 Pa·s and the density is 970 kg/m³. This corresponds to a kinematic viscosity of 0.03 Pa·s (30 000 cs). The kinematic viscosity is the ratio between the viscosity and the density.

The only rheometer not described in section 3 is the NIST rheometer. It is a parallel plate rheometer normally used for polymers or oils. It consists of two plates with a smooth surface and a diameter of 35 mm. The rheometer is controlled by a computer that changes rotation speed in decreasing or increasing steps and measures torque on the top plate. The temperature of the material under test is also controlled by a circulating water bath. The gap or distance between the plates can be adjusted. This rheometer is calibrated using standard oils. Further details on this rheometer are given in Ref. [30].

4.2. Results and Discussion

Using the calibrated NIST rheometer, two measurements were done with the oil at a temperature of 24.4 °C ± 0.4 °C. Each measurement was performed at two gaps of 1 mm and 0.5 mm ± 0.001 mm. The viscosity obtained was 29.5 Pa·s ± 0.6 Pa·s. This value was taken as the reference for analysis of the results from the concrete rheometers.

Table 5 shows the results obtained with the oil with the concrete rheometers. All the details, data and curves are shown in Appendix A. It should be noted that the BTRHEOM could not be used to measure the oil as shown by the associated negative viscosity. The reason for this is given below. Correction coefficients were calculated by dividing the viscosity by the reference viscosity for all rheometers except the BTRHEOM. These factors are shown in Table 5. Results from two rheometers are within 30 % error of the correct value (BML and Two-Point test). The IBB reports a value 3 times higher than the correct value. This is not surprising as the IBB is not calibrated against an oil and does not report viscosity in fundamental units.

It is worth examining why the BTRHEOM was not able to measure the oil. It should be said that the BTRHEOM is not designed to measure Newtonian liquids as shown by the negative values measured (Table 5). The following section regarding the inappropriateness of testing oil in the BTRHEOM is a direct excerpt from personal email correspondence [31]:

Testing oil with the BTRHEOM is of little relevance, because the rheometer is designed to characterize granular fluids of soft to fluid consistency (i.e. slump value higher than 100 mm). A torsional motion is imposed to the hollow,

cylindrical material specimen, by using two systems of blades (one at the bottom, one at the top of the specimen). The lower blades avoid rotation of the lower section of the specimen, while the upper blades force concrete to rotate around the vertical axis. Between these two sections, concrete can only have a torsional motion - i.e. a local particle rate that is a linear function of both radius and height - provided that the vertical walls do not perturb this theoretical rate field. In reality, a friction takes place in the vicinity of vertical walls, but, thanks to the spontaneous formation of a limit layer (made up with water and fine elements), this friction is low (much lower than the concrete yield stress). This assumption has been demonstrated both by experiments and numerical simulations [25]. Replacing concrete by oil, the level of friction will be the same, whatever the bounds of the specimen (horizontal or vertical). In addition, the blades will create local turbulent motion in the oil. The result will be a rate field quite different from the torsional one, which is accounted for in the calculation of Bingham constants. As a conclusion, it is not the nature of rheological behavior which matters (Newton or Bingham), but the granular nature of the material. The BTRHEOM is suitable for concrete, less suitable for mortar, unsuitable for grout and any other fine material, including water, oil, etc...

The results obtained from the UIUC rheometers are shown in Appendix A. The frictional torque T was about 1 N·m. The calculated yield stress was 102 Pa and plastic viscosity was 283 Pa·s. It can be seen that the viscosity value is about ten times higher than the expected value. To test the reproducibility of rheological measurements, testing was repeated twice. It was found that there was no significant difference from the previous results. One possible reason for this discrepancy could be similar to the one described for the BTRHEOM as both rheometers have a similar geometry.

Table 5: Results with oil using the various rheometers

Mixture Reference	BML		BTRHEOM*		IBB		IBB portable		Two-point Test		UIUC rheometer	
	Yield Stress τ_o (Pa)	Plastic Viscosity μ (Pa·s)	Yield Stress τ_o (Pa)	Plastic Viscosity μ (Pa·s)	Yield Stress τ_o (N·m)	Plastic Viscosity μ (N·m·s)	Yield Stress τ_o (N·m)	Plastic Viscosity μ (N·m·s)	Yield Stress τ_o (Pa)	Plastic Viscosity μ (Pa·s)	Yield Stress τ_o (Pa)	Plastic Viscosity μ (Pa·s)
O1	9	24	357	32	0.0 (-0.333)	10.02	0.0 (-0.182)	11.04	0♣	49	102	282.9
O2	9	24	444	-8	0.0 (-0.328)	10.03	0.0 (-0.170)	11.03	0♣	44	19	331.8
O3	-	-	221	-23	-	--	-	-	0♣	39	0♣	397.3
Average value		24.0 ± 0.0		N/A		10.0 ± 0.01		11.0 ± 0.01		44 ± 4		337.3 ± 35
Correction factor		1.23				2.94		2.67		0.67		0.087

♣ negative recorded values for yield stress, which can be considered as zero

* The BTHREOM is not designed to measure oil as discussed in the text.

5. Results for Concrete and Mortar Mixtures

Table 6 shows the results obtained by the rheometers on the concrete and mortar mixtures, in test order within each group. (Details of the mixtures and the single point test results – slump etc. – have been given in Table 2 to Table 4). The results from the BML, BTRHEOM and the two-point workability test are in fundamental units (Pa and Pa·s for yield stress, τ_0 and plastic viscosity, μ , respectively). However, the results of IBB and IBB portable are in N·m and N·m·s for the yield (G) and plastic viscosity (H) terms, respectively.

The range of rheological properties obtained for the concrete mixtures by each instrument is shown in Figure 18. As intended, a wide range of combinations was obtained. The BML and BTRHEOM show a largely similar pattern, with the two-point and IBB both showing a pattern lacking a high yield stress/high plastic viscosity region, largely due to high plastic viscosities recorded by both instruments for some of the low yield stress mixtures.

For comparison, the ranges obtained in the tests at LCPC are shown in Figure 19. It can be seen that these included mixtures with higher yield stresses. The MB tests have a greater number of mixtures with low yield stresses, as in the experimental plan.

Table 6: Results obtained with all mixtures. The mixture # is given to simplify the plot of some data in graphs.

Mixture #		BML		BTRHEOM		IBB		IBB portable		Two-point Test	
		Yield Stress	Plastic Viscosity	Yield Stress	Plastic Viscosity	Yield Stress	Plastic Viscosity	Yield Stress	Plastic Viscosity	Yield Stress	Plastic Viscosity
		τ_o (Pa)	μ (Pa·s)	τ_o (Pa)	μ (Pa·s)	g (N·m)	h (N·m·s)	g (N·m)	h (N·m·s)	τ_o (Pa)	μ (Pa·s)
	Concrete										
1	D1M1Conc	-	-			6.94	7.86	7.16	10.01	855	14
2	D1M2Conc	-	-	1236	110	3.84	7.97	5.34	8.69	665	26
3	D1M3Conc	273	24	1005	103	2.09	5.90	3.22	7.44	534	30
4	D1M4Conc	300	36	864	114	2.73	7.60	3.90	9.11	533	14
5	D1M5Conc	528	28	1084	69	4.92	6.83	5.98	7.73	812	♥
6	D2M1Conc	584	32	1120	127	5.63	9.37	7.50	9.22	933	♥
7	D2M2Conc	39	22	324	100	0.34	9.05	1.25	11.29	198	54
8	D2M3Conc	3	57	161	143	0.0 (-1.97)	47.42	0.0 (-1.57)	37.67	121	163
9	D2M4Conc	30	38	491	102	0.75	17.50	0.73	25.38	30	98
10	D2M5Conc	55	58	88	164	0.73	26.52	0.69	30.35	245	117
11	D2M7Conc	38	55	158	138	0.33	26.24	0.48	26.86	155	107
12	D3M1Conc	416	46	628	167	4.18	10.52	4.40	14.29	505	27
13	D3M2Conc	35	17	283	52	0.66	8.04	0.78	9.42	71	46
14	D3M3Conc	303	36	925	134	2.64	10.23	3.50	12.28	427	54
15	D3M4Conc	290	23	670	105	1.39	6.27	2.72	6.86	451	44
16	D3M5Conc	55	42	233	91	0.53	18.16	1.00	18.82	130	70
17	D3M6Conc	235	39	687	71	3.27	13.50	3.36	16.09	268	74
	Mortar										
18	D1M1Mort	-	-	742 (131)*	100 (149)*	1.13	2.09	1.60	1.91	208	♥
19	D1M2Mort	-	-	634	2	1.12	2.14	1.46	2.07	177	15
20	D2M1Mort	224	2	550	1	1.19	1.95	1.65	1.93	240	♥
21	D2M5Mort	254	16	345	66	2.07	5.78	2.27	6.23	181	23
22	D2M6Mort	16	6	177	50	-	-	0.0 (-0.15)	3.91	0▲	19

♥ the recorded plastic viscosity values were low or negative for these mixtures. The yield stress values were high (and slumps relatively low) and we believe that during testing the air pockets created immediately behind the impeller blades may not have refilled with concrete or mortar before the next pass of the blade, resulting in falsely low values of torque at increasing impeller speed, and hence invalid plastic viscosity. There is sufficient confidence in the yield stress values for their use in the subsequent analysis.

♠ negative recorded values for yield stress, which can be considered as zero

* Values in parenthesis are from a second test for the BTHREOM

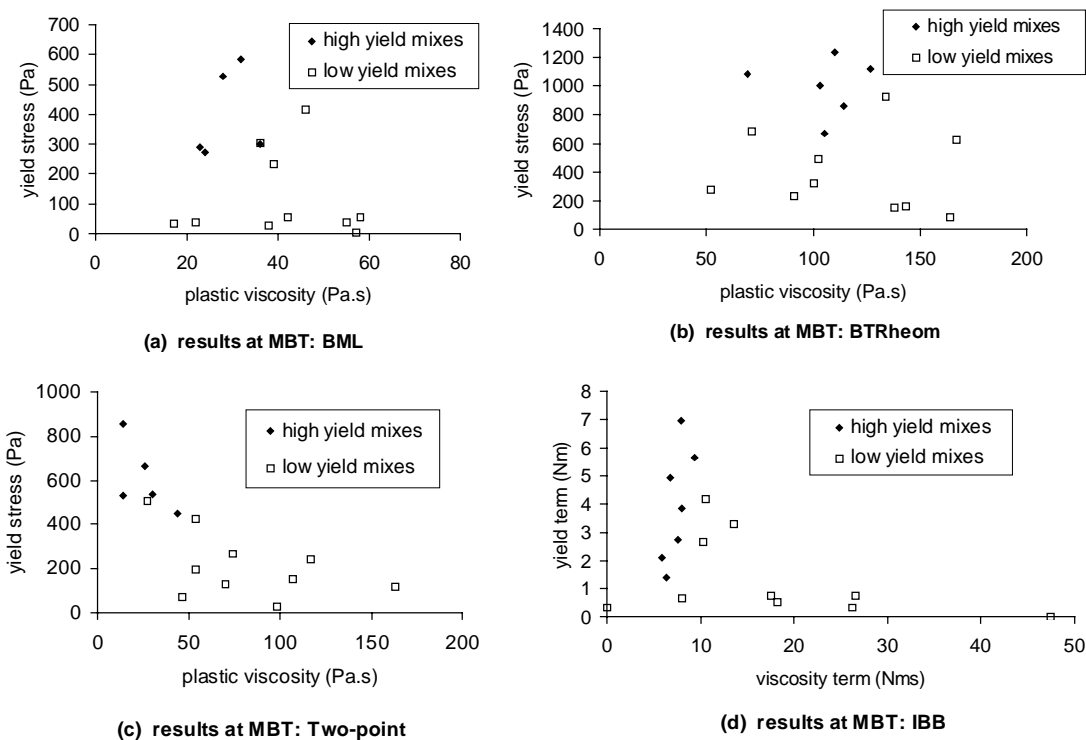

Figure 18: Range of Bingham properties measured in tests at MB

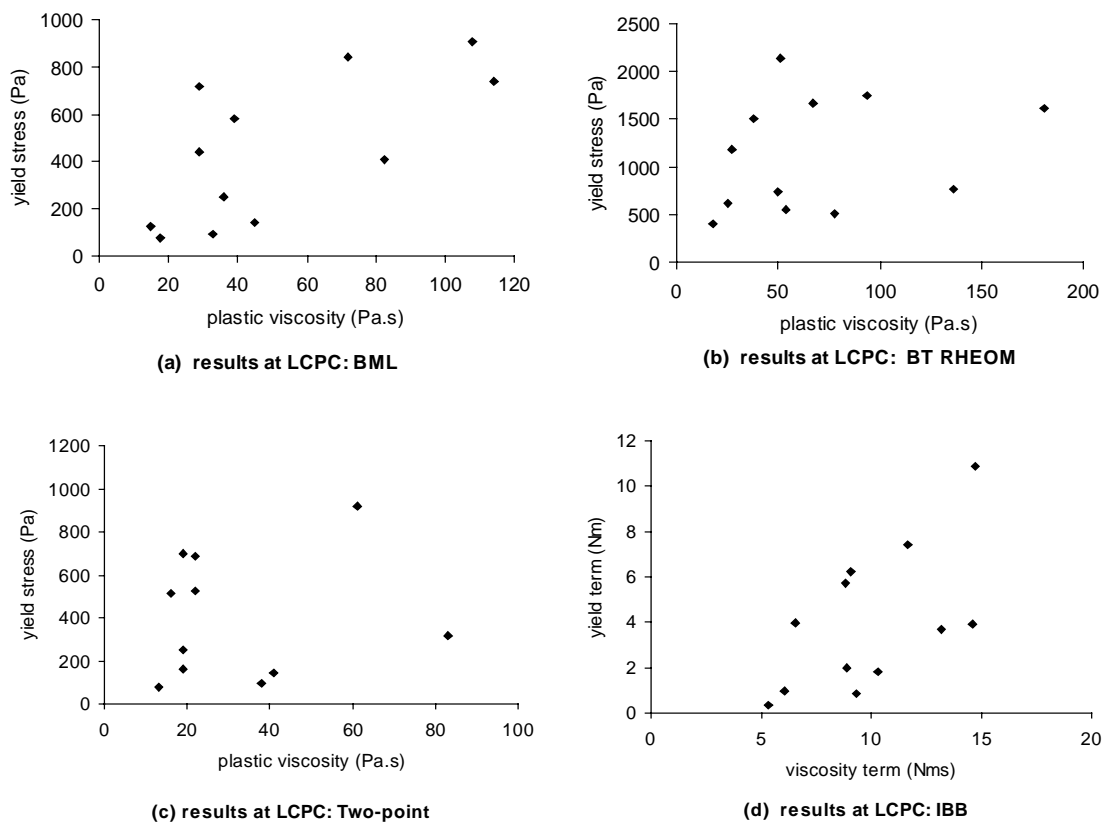

Figure 19: Range of Bingham properties measured in tests at LCPC

6. Discussion of Results with Concrete and Mortar

6.1. Correlation Between Single Point Tests and Rheometer Results for Concrete

For the tests on concrete, the correlation coefficients R for the relationships between the yield stress values and the slump, slump flow, T_{50} and V-funnel measurements are shown in the last three columns of Table 7, and those for the corresponding relationships with plastic viscosity in the last three columns of Table 8. The significance of the correlation can be assessed using Table 9, which gives, for two levels of confidence, the maximum values of absolute value of R that could be obtained by chance alone when no correlation exist. Where available, the coefficients for the previous tests at LCPC are also given in Table 7 and Table 8. Table 7 shows that good correlations with absolute values of coefficients greater than 0.8 (except for one value) were obtained between the yield stresses for each instrument and both slump (as in the LCPC tests) and slump flow values. The relationships are shown in Figure 20 and Figure 21. Poor correlations were obtained between the yield stresses and the T_{50} and V-funnel values, which is to be expected, as these are measurements of flow rate.

The correlations between the plastic viscosity values and slump and slump flow values are poor, but with the T_{50} and V-funnel values are good (Table 8), again as expected. These are shown in Figure 22 and Figure 23 respectively, with Figure 22 showing that in most cases the correlation would be improved if one or two outlying data points were ignored.

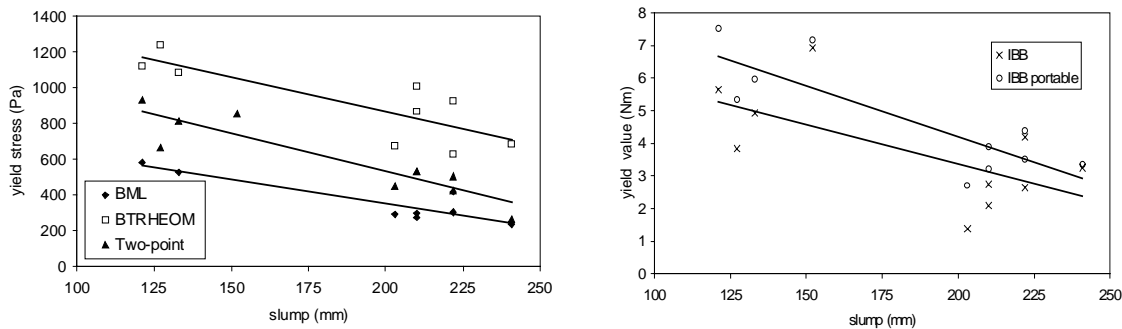

Figure 20: Relationships between yield stress/yield term and slump for concrete mixtures

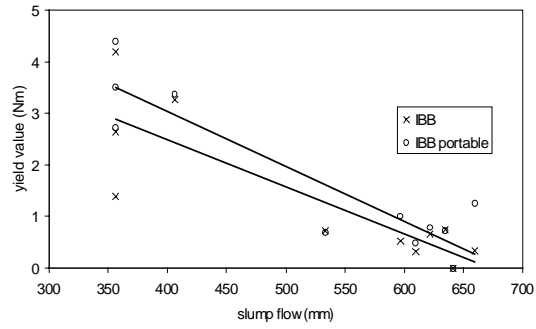
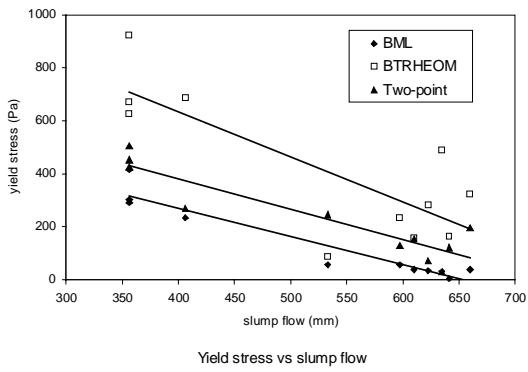

Figure 21: Relationships between yield stress/yield term and slump flow for concrete mixtures

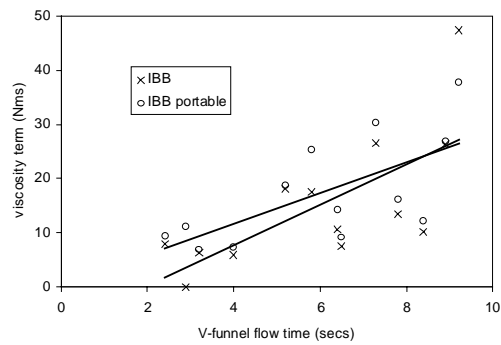
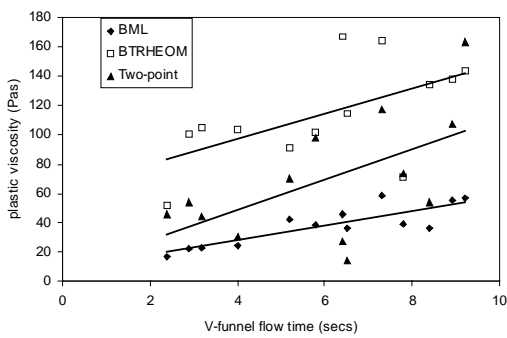

Figure 22: Relationships between plastic viscosity/viscosity term and V-funnel flow time for concrete mixtures

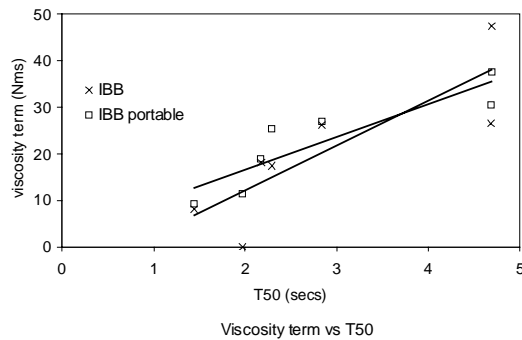
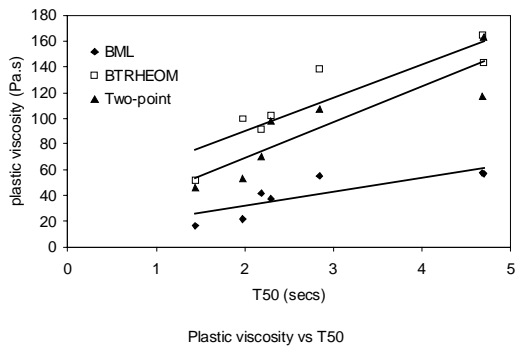

Figure 23: Relationships between plastic viscosity/viscosity term and T₅₀ times for concrete mixtures

6.2. Comparison Between Rheometers

6.2.1. General Trends

Figure 24 and Figure 25 have been plotted from the data in Table 6 and show the yield stress and plastic viscosity values respectively plotted against mixture number. To simplify the graphs, the results from the IBB portable, which are very similar to those from the IBB, have not been plotted in either graph.

As with the tests at LCPC [3], all the rheometers show similar trends for both constants, which is again very encouraging. Also as at LCPC, the yield stresses appear to be the more consistent, i.e., the trends are the same for all rheometers.

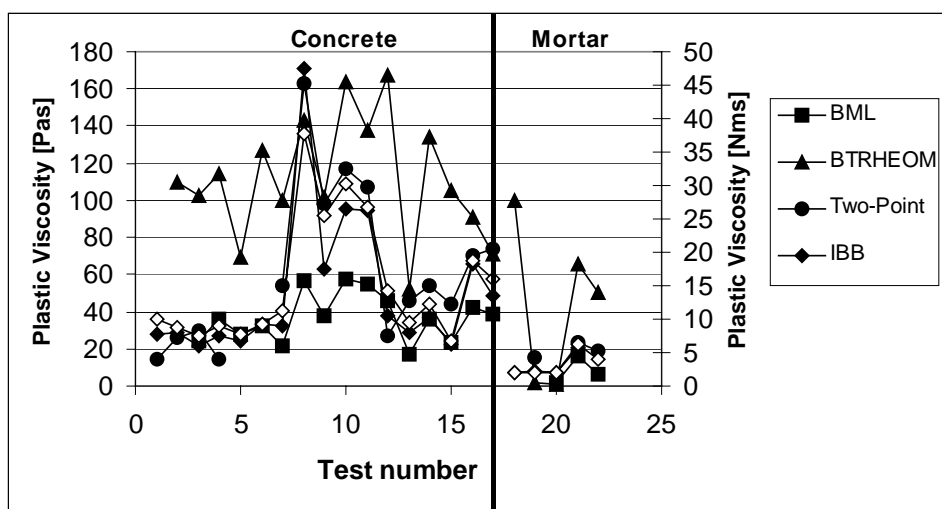

Figure 24: Plastic viscosity vs. concrete or mortar mixtures. The lines connecting the points are only used to guide the eye and are not meant as implication of a relationship between the points.

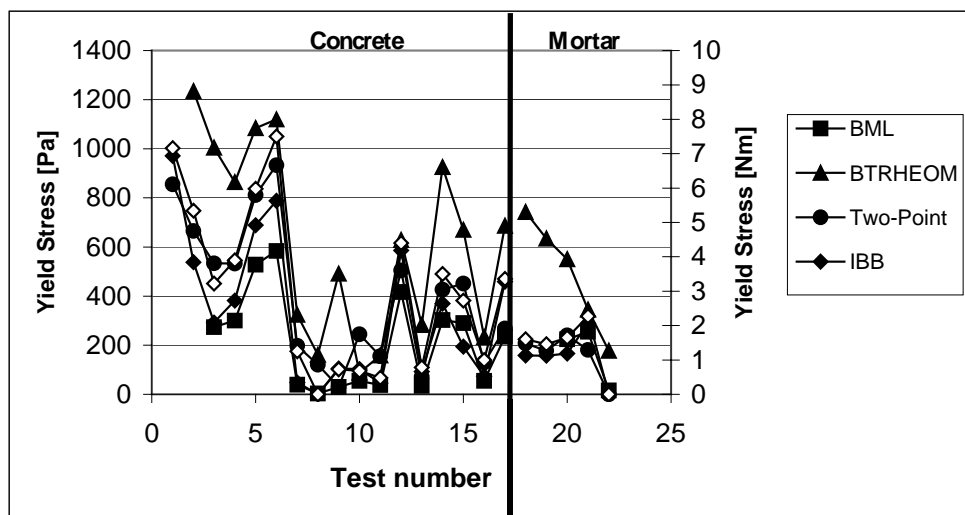

Figure 25: Yield stress vs. concrete or mortar mixtures. The lines connecting the points are only used to guide the eye and are not meant as implication of a relationship between the points.

6.2.2. Comparison of measurements on concrete mixtures

The correlation coefficients, R , for results between pairs of rheometers are given in columns 3 to 6 of Table 7 and Table 8 for yield stress and plastic viscosity respectively, together with the corresponding values from the LCPC tests where these exist. Yield stress coefficients (Table 7) are all higher than 0.84, indicating good correlation (Table 9). The highest values were obtained between BML vs. IBB portable (0.98) and IBB vs. IBB portable (0.97). Plastic viscosity coefficients (Table 8) are generally lower. The absolute values of the coefficients for those relationships between the BTRHEOM and the two-point, IBB and IBB portable are all less than 0.5, indicating poor correlation.

The regression coefficients for the relationships are given in Table 10 and Table 11 for yield stress and plastic viscosity respectively, and the data and regression lines are plotted in figures 25(1) and (2), and 26(1) and (2).

None of the slope coefficients for either the yield stress or plastic viscosity relationships between the three instruments that give values in fundamental units are close to the ideal value of 1. However, the values of slopes for the IBB and IBB portable correlations are, as would be expected, closer to 1 (1.12, 0.844, 1.11, 0.815 from Table 10 and Table 11). The fact that they are not equal to 1 may be attributable to the nature of the rougher surface of the impeller used for IBB portable compared to that of the IBB.

The data and regression line plots for yield stress values (Figure 26 and Figure 27) all have a cluster of points at low yield stress, as intended in the experimental plan. The generally poorer correlations between the sets of plastic viscosities are apparent in Figure 28 and Figure 29, but, as before, in some cases much improved correlations would be obtained if one or two outlying points were ignored.

Table 7: Correlation coefficients R for yield stress values of concrete mixtures

	BML	BTRHEOM	Two-point	IBB	IBB portable	slump	slump flow	T50	V-funnel time
BML		0.89 (0.97)	0.96 (0.94)	0.96 (0.81)	0.98	-0.90 (-0.96)	-0.95	-0.27	0.00
BTRHEOM			0.86 (0.97)	0.84 (0.82)	0.90	-0.82 (-0.95)	-0.80	-0.66	-0.11
Two-point				0.91 (0.90)	0.96	-0.91 (-0.96)	-0.92	0.48	-0.03
IBB					0.97	-0.65 (0.86)	-0.85	-0.35	0.14
IBB portable						-0.84 (-0.94)	-0.91	-0.69	-0.03

() : coefficients R from tests at LCPC

Table 8: Correlation coefficients R for plastic viscosity of concrete mixtures

	BML	BTRHEOM	Two-point	IBB	IBB portable	slump	slump flow	T50	V-funnel time
BML		0.71 (0.84)	0.70 (0.45)	0.83 (0.96)	0.86	0.38	0.07	0.85	0.86
BTRHEOM			0.30 (0.79)	0.45 (0.86)	0.45	0.15	-0.23	0.90	0.58
Two-point				0.90 (0.52)	0.95	0.58	0.52	0.89	0.57
IBB					0.94	0.39	0.35	0.83	0.70
IBB portable						0.54	0.48	0.89	0.67

() : coefficients R from tests at LCPC

Table 9: Critical values for the absolute value of the correlation coefficient R of a sample extracted from a normal distribution. A is the confidence, and $\gamma = n - 2$, where n is the number of points.

α	95 % confidence	99 % confidence
	2 variables	2 variables
γ	$ R $	$ R $
14	0.497	0.623
15	0.482	0.606
16	0.468	0.590
17	0.456	0.575

Table 10: Coefficients of regression A and B for yield stress of concrete mixtures ($Y = A X + B$)

	BML		BTRHEOM		Two-point		IBB		IBB portable		Slump	
	(Pa)		(Pa)		(Pa)		(N·m)		(N·m)		(mm)	
	A	B	A	B	A	B	A	B	A	B	A	B
BML (Pa)			1.66	229.9	1.34	76.6	0.0090	0.062	0.0113	0.221	-0.258	288.8
BTRHEOM (Pa)	0.48	-64.0			0.61	1.17	0.0040	-0.363	0.0053	-0.493	-0.134	310.6
Two-point (Pa)	0.688	-36.16	1.225	156.8			0.0067	-0.342	0.0081	-0.267	-0.194	302.2
IBB (N·m)	102.4	9.51	178.2	249.2	123.6	114			1.12	0.383	-24.25	280.6
IBB portable (N·m)	85.5	-11.7	154.4	191.9	113.5	61.84	0.844	-0.196			-22.56	291.8
Slump (mm)	-3.58	1050	-6.14	2018	-4.75	1468	-0.032	9.52	-0.04	11.87		

Notes: in Table 10 and Table 11:

$$Y = A X + B, \text{ where } Y = \text{column titles, } X = \text{row titles}$$

Table 11: Coefficients of regression A and B for plastic viscosity of concrete mixtures ($Y = A X + B$)

	BML		BTRHEOM		Two-point		IBB		IBB portable	
	(Pa·s)		(Pa·s)		(Pa·s)		(N·m·s)		(N·m·s)	
	A	B	A	B	A	B	A	B	A	B
BML (Pa·s)			1.84	44.3	2.15	-12.4	0.698	-10.85	0.683	-7.10
BTRHEOM (Pa·s)	0.272	6.39			0.387	21.9	0.151	-2.47	0.138	0.1692
Two-point (Pa·s)	0.227	22.3	0.233	98.47			0.246	-0.52	0.210	3.14
IBB (N·m·s)	0.927	23.1	1.32	92.76	3.52	10.3			0.815	3.88
IBB portable (N·m·s)	1.17	17.6	1.65	85.9	4.26	-6.65	1.11	-3.03		

Notes: in Table 10 and Table 11:

$$Y = A X + B, \text{ where } Y = \text{column titles, } X = \text{row titles}$$

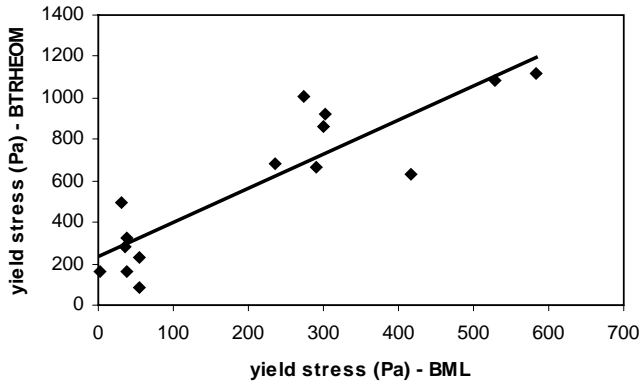

(a) yield stress - BTRHEOM vs BML

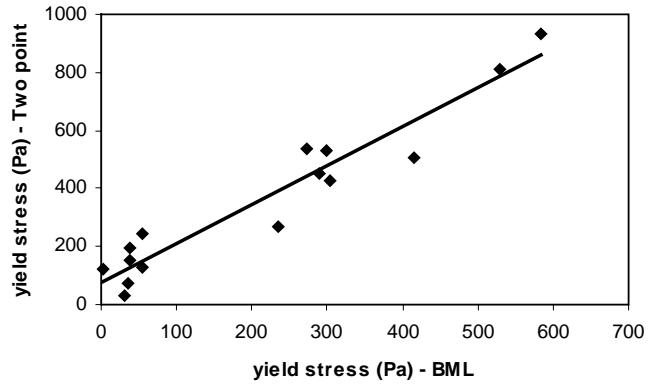

(b) yield stress - Two-point vs BML

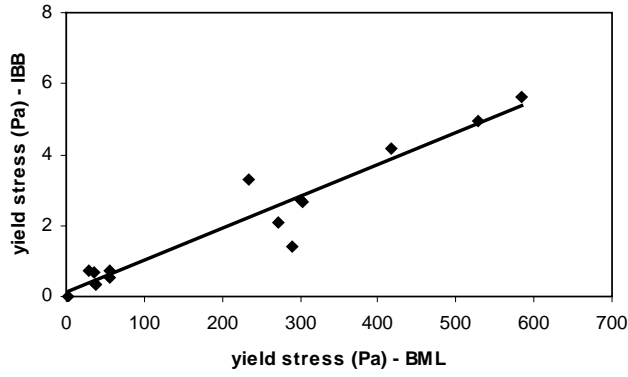

(c) yield stress - IBB vs BML

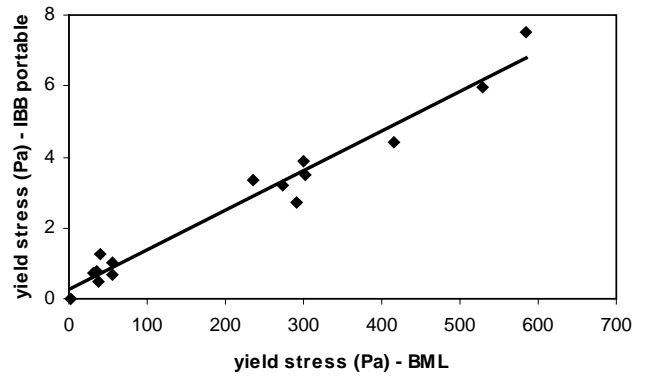

(d) yield stress - IBB portable vs BML

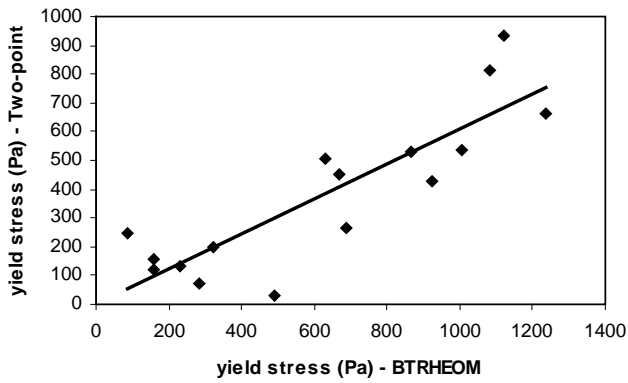

(e) yield stress - Two-point vs BTRHEOM

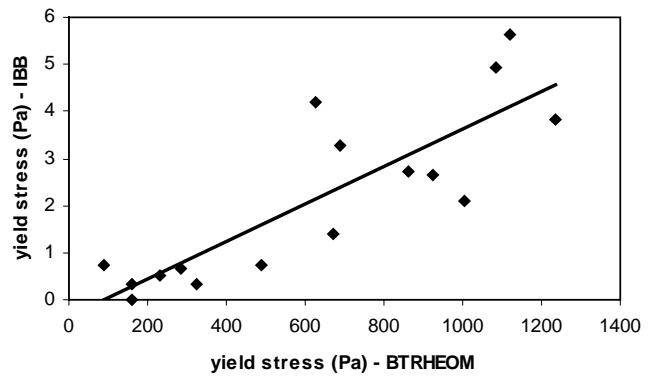

(f) yield stress - IBB vs BTRHEOM

Figure 26: Yield stress correlations

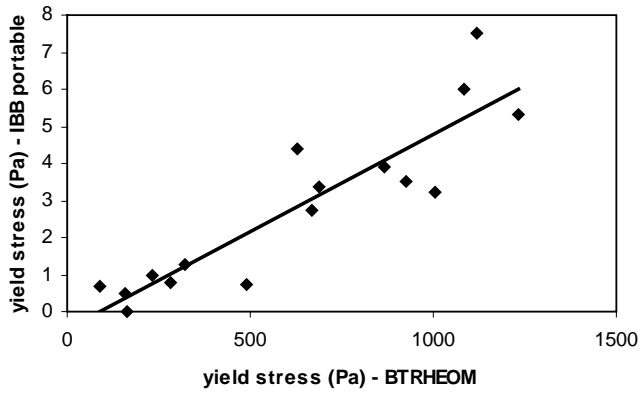

(g) yield stress - IBB portable vs BTRHEOM

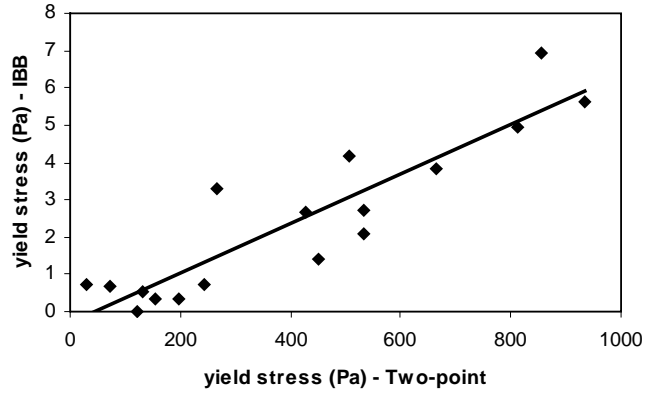

(h) yield stress - IBB vs Two-point

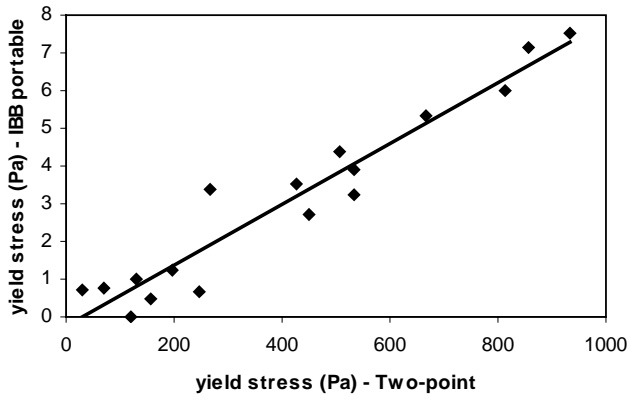

(i) yield stress - IBB portable vs Two-point

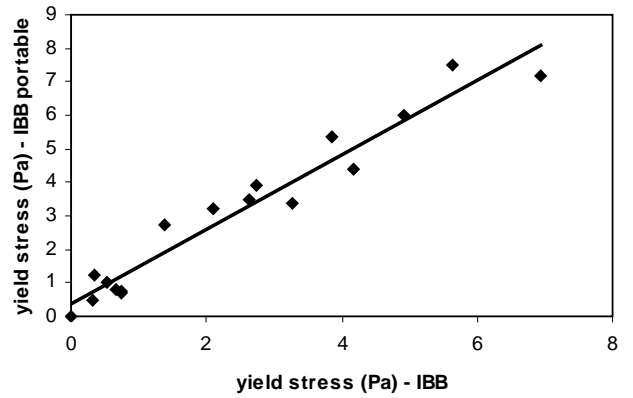

(j) yield stress - IBB portable vs IBB

Figure 27: Yield stress correlations (cont)

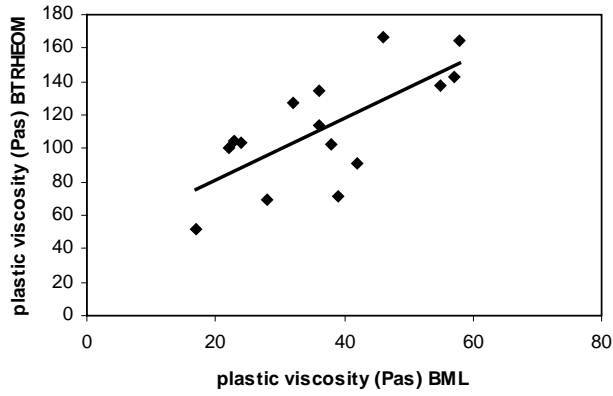

(a) plastic viscosity - BTRHEOM vs BML

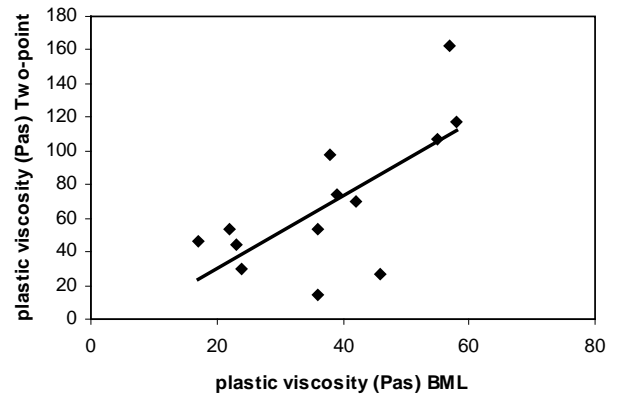

(b) plastic viscosity - Two-point vs BML

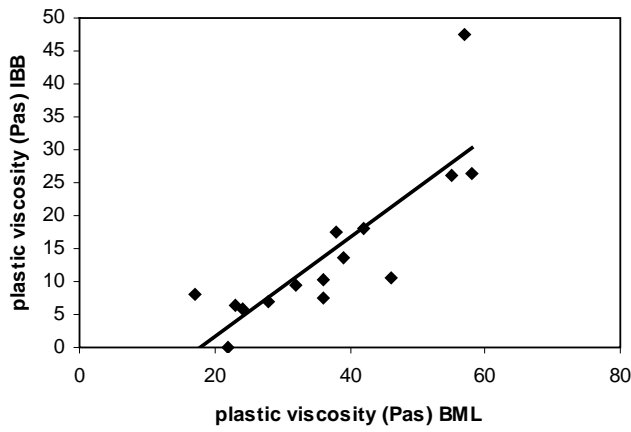

(c) plastic viscosity - IBB vs BML

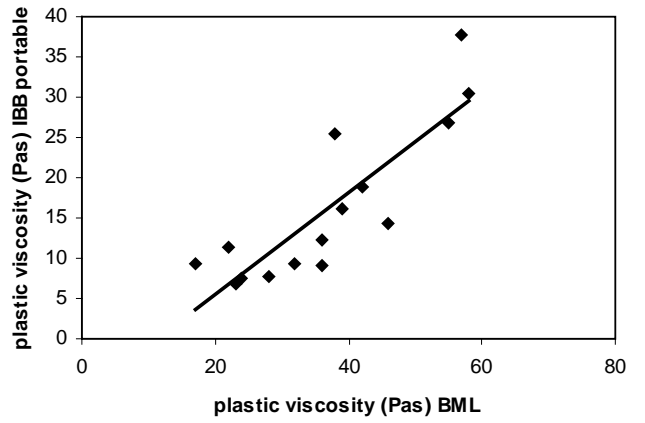

(d) plastic viscosity - IBB portable vs BML

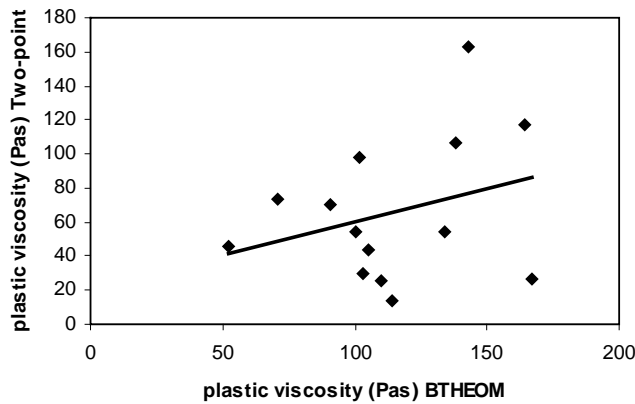

(e) plastic viscosity - Two-point vs BTRHEOM

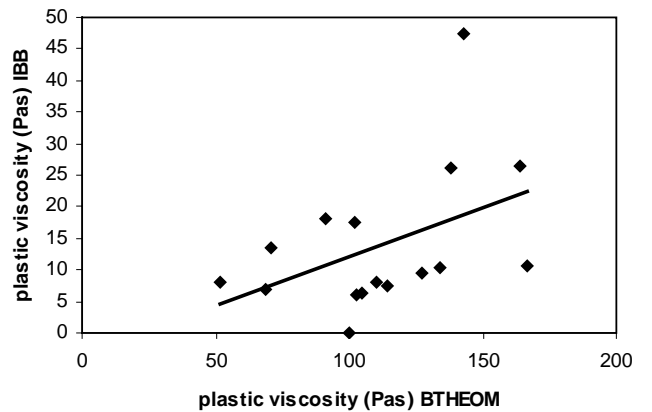

(f) plastic viscosity - IBB vs BTRHEOM

Figure 28: Plastic viscosity correlations

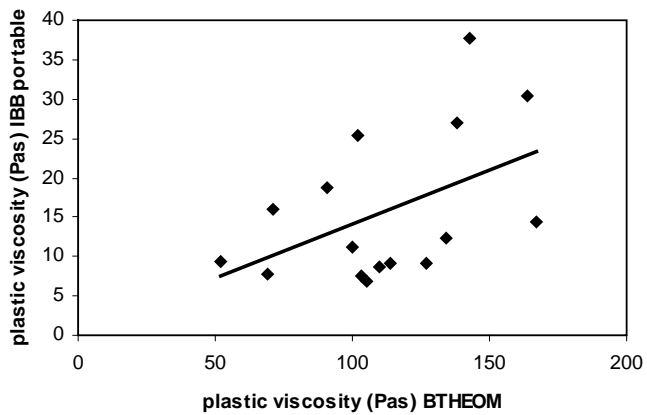

(g) plastic viscosity - IBB portable vs BTRHEOM

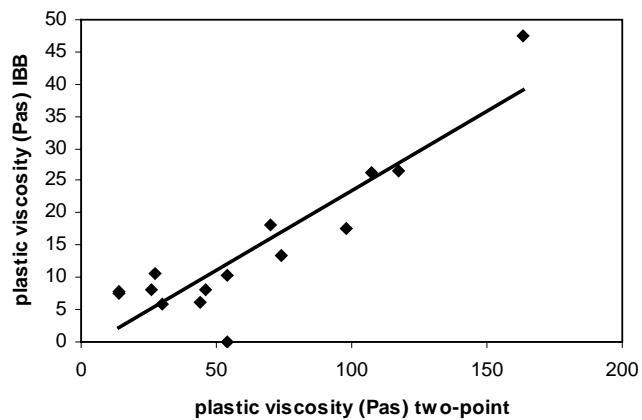

(h) plastic viscosity - IBB vs Two-point

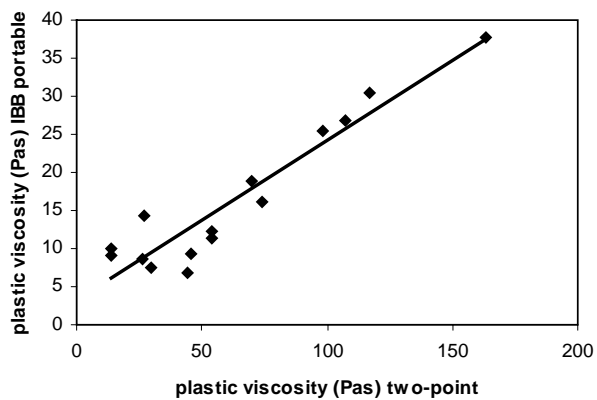

(i) plastic viscosity - IBB portable vs Two-point

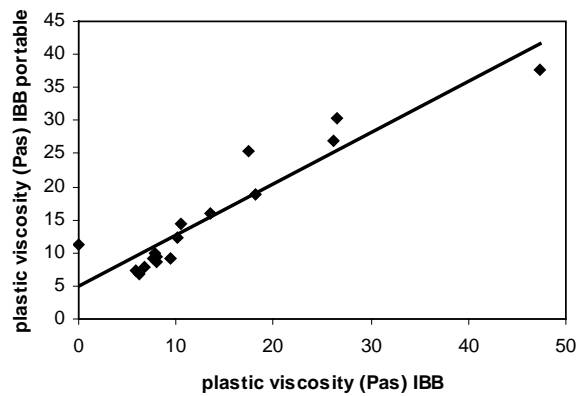

(j) plastic viscosity - IBB portable vs IBB

Figure 29: Plastic viscosity correlations (cont)

6.2.3. Ranking of the concrete mixtures by the various rheometers

The graphs of yield stress and plastic viscosity versus mixture number (Figure 24 and Figure 25) show there is some similarity between the results of the different rheometers. The next step, as it was in Phase I, is to compare the classification of the concrete mixtures by apparatus.

This type of comparison can be quantified by Kendall's coefficient of concordance, W , [32] (see Appendix E of ref. [3]). First, the ranking was established for each concrete by each rheometer, both for yield stress (Table 12) and plastic viscosity (Table 13). This comparison is made only on the rank given by each apparatus, which enables one to include the IBB (for both "equivalent" yield stress and plastic viscosity). Nevertheless, the same number of data points should be available for each rheometer. This precludes mixtures # 5 and 6 from plastic viscosity measurements and mixtures #1 and 2 from both measurements.

From the tables, it is clear that there is some correlation between the various devices for both yield stress and plastic viscosity. For instance, Mixtures #5 and, #6, show similar rankings for yield stress (Table 12). Mixtures #8, #10 and #11 show similar ranking for the plastic viscosity (Table 13).

Table 12: Ranking of the yield stress of the concrete mixtures as determined by the rheometers. The mixtures are ranked in increasing order of yield stress from 1 to 15.

Ranking according to	Concrete Mixtures														
	3	4	5	6	7	8	9	10	11	12	13	14	15	16	17
BML	9	11	14	15	5	1	2	6	4	13	3	12	10	7	8
BTRHEOM	13	11	14	15	6	3	7	1	2	8	5	12	9	4	10
IBB	9	11	14	15	3	1	7	6	2	13	5	10	8	4	12
IBB Portable	9	12	14	15	7	1	4	3	2	13	5	11	8	6	10
Two-Point	13	12	14	15	6	3	1	7	5	11	2	9	10	4	8

Table 13: Ranking of plastic viscosity of the concrete mixtures as determined by the rheometers. The mixtures are ranked in increasing order of yield stress from 1 to 13.

Ranking according to	Concrete Mixtures												
	3	4	7	8	9	10	11	12	13	14	15	16	17
BML	4	6	2	12	7	13	11	10	1	5	3	9	8
BTRHEOM	6	8	4	11	5	12	10	13	1	9	7	3	2
IBB	1	3	5	13	9	12	11	7	4	6	2	10	8
IBB Portable	2	3	5	13	10	12	11	7	4	6	1	9	8
Two-Point	3	1	6	13	10	12	11	2	5	7	4	8	9

Calculations of the Kendall's coefficient of concordance, W (Appendix E of ref. [3]), show it to be equal to 0.89 for yield stress and 0.72 for plastic viscosity. To test the significance of the observed value of W , the distribution of W is considered in the

customary way to reject or accept the hypothesis that the classifications are independent. That is, the classifications are not independent (at the 95 % confidence level) if the value of W is greater than a reference value. Since the number of samples is greater than 7, the following approximation is used to obtain the reference value [see ref 32 p. 98]. In the equation $\chi_r^2 = b(a-1)W$, χ_r^2 is distributed in the form known in statistics as χ^2 with $\nu = a-1$ degrees of freedom, where a is the number of samples (15 for yield stress and 13 for plastic viscosity) and b is the number of devices (5 in this case). For yield stress, $\chi_r^2 = b(a-1)W = 5 \times (15-1) \times .89 = 62.3$, which is greater than $\chi_{\nu=15-1=14, .05}^2 = 23.7$. For viscosity, $\chi_r^2 = 43.4$, which is greater than $\chi_{12, .05}^2 = 21.0$. The tests show that the classifications by the various devices are not independent. This implies that the rheometers can be used to statistically rank the mixtures in the same order. From looking at Table 12 and Table 13, it can be seen that quite a few rheometer rank some mixtures at the same level. For instance, mixture 5 and 6 for yield stress are in position 14 and 15 respectively for all rheometers. Quite a few of the other mixtures have the same position attributed by at least 3 rheometers.

6.2.4. Comparison of Results from Phase I (2000) and Phase II (2003) [3]

Only the concrete mixtures from Phase II are compared with the Phase I data. Comparing the correlation coefficients for yield stress measurements obtained in the two series (Table 7) shows that they were very similar. The coefficients for the plastic viscosity (Table 8) are again generally lower than for yield stress, but have a wider range (as low as 0.3 for BTRHEOM vs. Two-point). Table 14 and Table 15 give the correlation coefficients calculated using all data from both phases. Regression coefficients for the yield stresses and plastic viscosities for all concrete mixtures prepared in both phases are given in Table 16 and Table 17, respectively.

Figure 30 and Figure 31 give a comparison between the data and regression lines obtained for the four rheometers used both in the current tests and in the tests at LCPC, again for yield stress and plastic viscosity respectively. Figure 30 shows broadly similar correlations in each case, with near coincident regression lines in three cases. All those involving the two-point test show a shift, which could indicate some change in the calibration of the two-point test. However, this was checked immediately after the apparatus returned from America, and no differences were obtained. Figure 31 shows the much greater variety of behavior for plastic viscosity.

Table 14: Correlation coefficients, R , for yield stress values (MB and LCPC) for the concrete mixtures.

	BML	BTRHEOM	Two-point	IBB	Slump
BML		0.95	0.91	0.88	- 0.95
BTRHEOM.			0.86	0.85	- 0.93
Two-point				0.88	- 0.90
IBB					- 0.86
Slump					

Table 15: Correlation coefficients, R , for plastic viscosity (MB and LCPC) for the concrete mixtures.

	BML	BTRHEOM	Two-point	IBB
BML		0.51	0.29	0.39
BTRHEOM			0.56	0.49
Two-point				0.90
IBB				

Table 16: Regression coefficients A and B for yield stress (MB and LCPC) for the concrete mixtures.

	BML		BTRHEOM		Two-point		IBB		Slump	
	(Pa)		(Pa)		(Pa)		(N·m)		(mm)	
	A	B	A	B	A	B	A	B	A	B
BML (Pa)			1.89	226.8	0.988	91.37	0.009	0.186	-0.219	274.2
BTRHEOM (Pa)	0.477	-77.37			0.475	14.51	0.004	-0.536	-0.110	294.2
Two-point (Pa)	0.831	-19.82	1.57	189.5			0.008	-0.252	-0.187	280.6
IBB (N·m)	90.81	54.54	176.3	325.1	99.6	124.7			-20.48	262.8
Slump (mm)	-0.22	274	-7.9	2434	-4.3	1290	-0.032	9.37		

Table 17: Regression coefficients A and B for plastic viscosity (MB and LCPC) for the concrete mixtures.

	BML		BTRHEOM		Two-point		IBB	
	(Pa·s)		(Pa·s)		(Pa·s)		(N·m·s)	
	A	B	A	B	A	B	A	B
BML			0.930	52.23	0.439	33.12	0.139	6.64
BTRHEOM	0.282	17.33			0.461	7.55	0.095	3.61
Two-point	0.197	33.11	0.676	59.94			0.213	2.09
IBB	1.12	29.3	2.513	61.79	3.76	1.96		

Notes: $Y = A X + B$, where $Y =$ column titles, $X =$ row titles

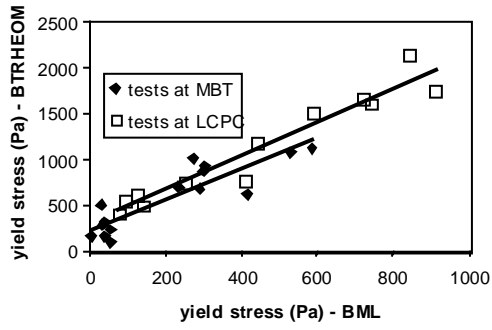

(a) BML/BTRHEOM

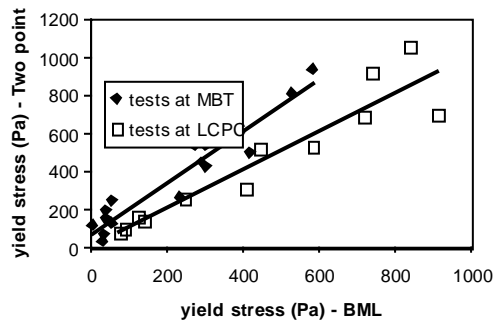

(b) BML/Two-point

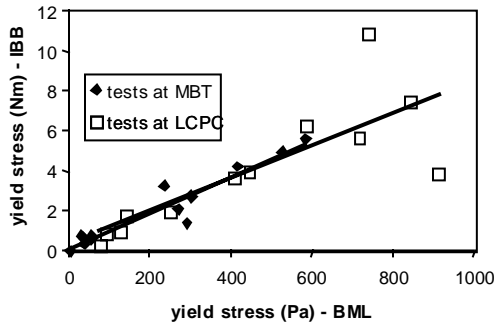

(c) BML/IBB

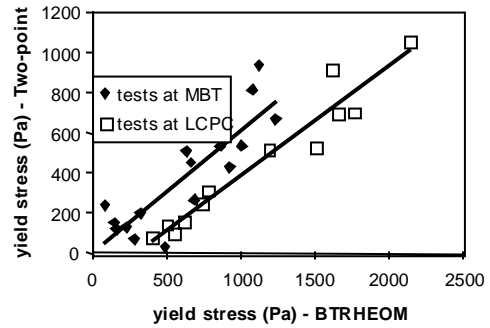

(d) BTRHEOM/Two-point

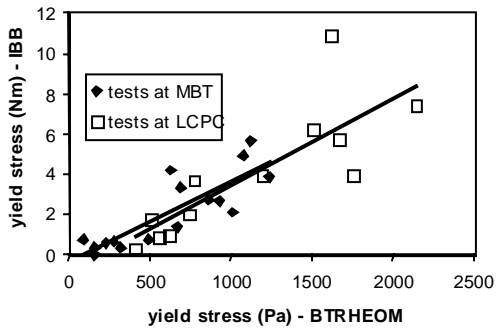

(e) BTRHEOM/IBB

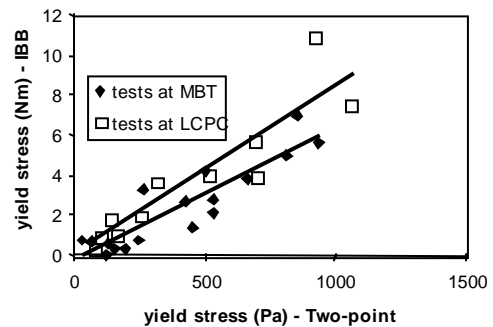

(f) Two-point/IBB

Figure 30: Yield stress correlations obtained at LCPC and MB for concrete mixtures

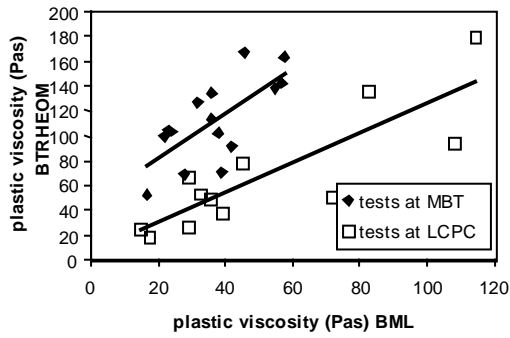

(a) BML/BTRHEOM

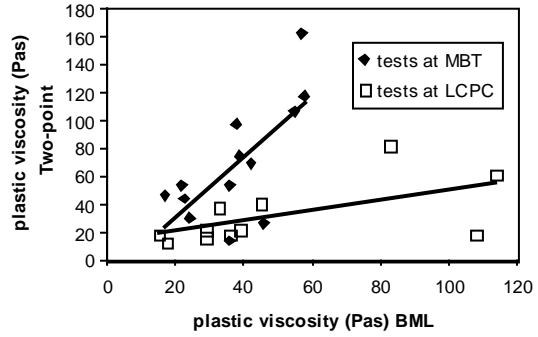

(b) BML/Two-point

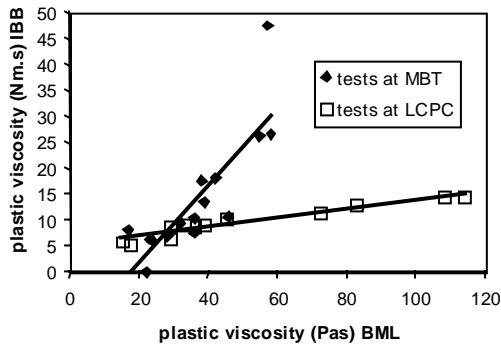

(c) BML/IBB

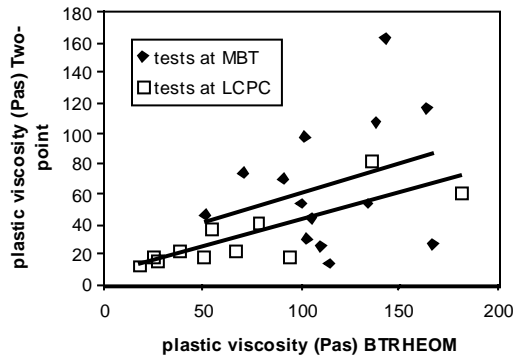

(d) BTRHEOM/Two-point

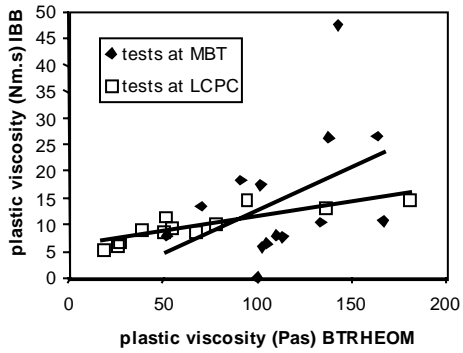

(e) BTRHEOM/IBB

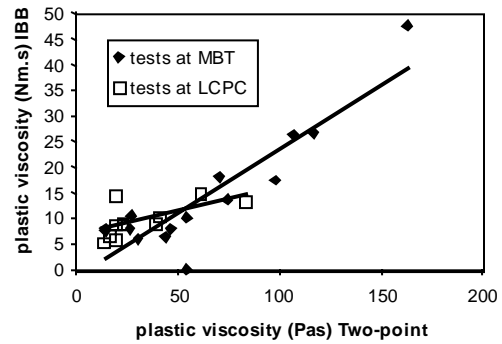

(f) Two-point/IBB

Figure 31: Plastic viscosity correlations obtained at LCPC and MB for concrete mixtures

6.3. Repeatability of Data

Three mixtures design were repeated three times to attempt to determine the repeatability of the results. The mixtures were:

- HiYld concrete: D1M1Conc, D1M2Conc, D2M1Conc
- LoYld concrete: D2M3Conc, D2M5Conc, D3M5Conc
- HiYld mortar: D1M1mort, D1M2mort, D2M1mort

Table 18 and Table 19 show the average, standard deviation and coefficient of variation in percentage for the yield stress and the plastic viscosity respectively determined from the rheometers. Table 20 shows instead the average, standard deviation and coefficient of variation of the other tests. The coefficient of variation (CV) is defined as the ratio of the standard deviation to the average in percentage.

In general, it seems that the CV as calculated in Table 18 and Table 19 is very high. Most of time the CV is higher than 10% and even as high as 166% in one case. This could be attributed to the fact that the concrete mixtures might not be exactly identical in composition. For instance, the water content, as shown in Table 2 - Table 4, does vary slightly. And also, the value of Δt varies for each mixture, in some cases widely. On the other hand, the results in Table 20 show a lower CV for most tests and concrete mixtures than the CV from Table 18 and Table 19. This could imply two interpretations: 1) the rheometer measurements are more sensitive to small changes than the non-rheometer tests; or 2) another factor, not identified here, corrupted the data. There are not enough data to be able to discriminate between these hypothesis.

In summary, these repeatability data are disappointing and it is not clear how to proceed, as the non-repeatability sheds a light of great uncertainty on all the data and correlation factors calculated here and in Phase I. This lack of repeatability should be confirmed by conducting many more tests, as three are not enough to adequately describe the statistical nature of the associated variability. Unfortunately, this was not possible under the current test program.

Table 18: Average yield stress for the mixture repeatability. No standard deviation was calculated when only one value was available.

Mixture type		BML [Pa]	BTHREOM [Pa]	IBB [N·m]	IBB portable [N·m]	Two- point [Pa]
HiYld Conc	Average	584.0	1177.5	5.5	6.7	817.7
	Standard Deviation		81.3	1.6	1.2	137.8
	CV [%]		7	28	17	17
LoYld Conc	Average	46.7	270.7	0.7	0.8	135.0
	Standard Deviation	14.4	204.1	0.1	0.2	107.6
	CV [%]	31	75	18	21	80
HiYld Mort	Average	224.0	642.0	1.1	1.6	208.3
	Standard Deviation		96.2	0.0	0.1	31.5
	CV [%]		15	3	6	15

Table 19: Average plastic viscosity for the mixture repeatability. No standard deviation was calculated when only one value was available.

Mixture type		BML [Pa·s]	BTHREOM [Pa·s]	IBB [N·m·s]	IBB portable [N·m·s]	Two- point [Pa·s]
HiYld Conc	Average	32.0	118.5	8.4	9.3	20.0
	Standard Deviation		12.0	0.8	0.7	8.5
	CV [%]		10	10	7	42
LoYld Conc	Average	46.0	119.0	20.7	24.9	95.0
	Standard Deviation	10.6	39.4	5.0	5.8	23.6
	CV [%]	23	33	24	23	25
HiYld Mort	Average	2.0	34.3	2.1	2.0	15.0
	Standard Deviation		56.9	0.1	0.1	
	CV [%]		166	5	4	

Table 20: Average for the non-rheometer tests

Mixture type		Slump (mm)	Slump Flow (mm)	U-box RiseHt (mm)	V-funnel time (s)
HiYld Conc	Average	133.3		201	
	Standard Deviation	16.4		29.4	
	CV [%]	12		14	
LoYld Conc	Average	244.5	470.0	368.3	2.1
	Standard Deviation	4.9	18.4	22.7	0.2
	CV [%]	2	4	6	10
HiYld Mort	Average		588.3	351.3	6.1
	Standard Deviation		51.5	4.0	1.1
	CV [%]		9	1	18

6.4. Relative Viscosity: Mortar and Concrete

It is clear from the results shown here and from the analysis in previous sections that the comparison of the absolute values of the rheometers can only be done through a fitted correlation curve. This is due to the fact that the units and other geometrical factors are widely different from rheometer to rheometer. Ferraris and Martys [33] have designed the concept of relative viscosity that could be used to compare results from rheometers with different geometries. They define the true or absolute plastic viscosity as the slope of the curve, shear stress vs. shear rate, corrected by a function, f , which depends on the rheometer geometry and experimental conditions. So the following equation could be used:

$$\frac{\Delta T}{\Delta V} = \eta_T \cdot f(M, C) \quad [5]$$

where $\Delta T / \Delta V$ = slope of the torque (T) versus rotational speed (V) = H
 η_T = true or absolute plastic viscosity
 $f(G, C)$ = function depending on the rheometer geometry (M) and experimental conditions (C).

The function f is not fully known for most of the concrete rheometers due to their complex geometry and the lack of a standard material that could be used for calibration. Therefore, to eliminate the function f from the calculation, they defined the relative viscosity the ratio, η_{T1}/η_{T2} , where the indices 1 and 2 stand for the two mixtures tested in the same rheometer. The equation (10) than could be written as follows:

$$\frac{\Delta T_1 / \Delta V_1}{\Delta T_2 / \Delta V_2} = \frac{\eta_{T1} \cdot f(G, C)}{\eta_{T2} \cdot f(G, C)} = \frac{\eta_{T1}}{\eta_{T2}} \quad [6]$$

For instance, material 1 could be the concrete while material 2 could be the mortar with the same composition of the concrete without the coarse aggregates. In equation (6) the relative viscosity does not depend on the rheometer used.

If this concept is applied to the results obtained here, a suitable reference mixture should be identified. The definition of relative viscosity in the rheology is usually given as [34] the ratio of the viscosity in a suspension (concrete as coarse aggregates in mortar) to the viscosity of the suspending medium (mortar). Obviously, a pseudo relative viscosity could be defined and another mixture could be used, but a mortar will be used as a reference to demonstrate the method.

In examining Table 6, it can be seen that only one mortar, “D2M5Mort”, has data for all rheometers. Ideally, the mortar and the concrete should be from the same matrix. Another

criterion for selection is to use the average of the one mortar that was repeated three times. Unfortunately as shown in section 6.3, it is clear that the error attached to that mortar and the missing data for some of the rheometers make it unusable. Therefore, the only reasonable possibility to calculate the relative viscosities for all the concrete was to use “D2M5Mort” as a reference. It is clear that if this approach was to be used, better data for the mortar would need to be obtained. Figure 32 shows the results obtained.

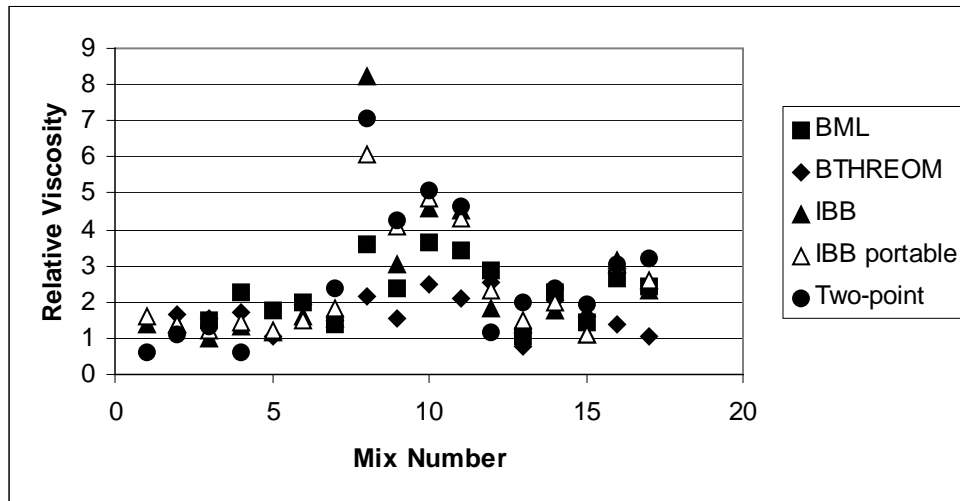

Figure 32: Relative viscosity (using D2M5Mort as a reference) for each rheometer as a function of the mixture number

To determine the spread of the relative viscosities for any mixture, the average, standard deviation and the coefficient of variation were calculated (Table 21). About 58 % of relative viscosities have a CV less than 30 %. The mortar used as a reference was arbitrarily selected as the only one for which all the rheometers reported a measurement. It could be expected that with a better reference the CV could be lowered further. Nevertheless, the comparison of the plastic viscosities using different rheometers is easier to achieve from Figure 32 than from Figure 24.

Due to flaws in the selection of the reference, this approach is given here as an illustration of another way to compare results from various rheometers. It should be kept in mind that otherwise the data from IBB and the other rheometers could not be plotted on the same graph using one Y-axis.

Table 21: Average relative viscosity and coefficient of variation (using D2M5Mort as a reference).

Mixture #	Mixture	Average	Standard Deviation	CV [%]
1	D1M1Conc	1.2	0.5	43.6
2	D1M2Conc	1.4	0.2	15.7
3	D1M3Conc	1.3	0.2	16.8
4	D1M4Conc	1.5	0.6	40.7
5	D1M5Conc	1.3	0.3	23.6
6	D2M1Conc	1.8	0.2	14.0
7	D2M2Conc	1.7	0.4	22.2
8	D2M3Conc	5.4	2.5	46.1
9	D2M4Conc	3.1	1.1	37.4
10	D2M5Conc	4.1	1.1	26.1
11	D2M7Conc	3.8	1.1	28.1
12	D3M1Conc	2.1	0.7	30.9
13	D3M2Conc	1.4	0.5	34.1
14	D3M3Conc	2.1	0.2	11.1
15	D3M4Conc	1.4	0.3	24.5
16	D3M5Conc	2.6	0.7	27.8
17	D3M6Conc	2.3	0.8	33.5

7. Summary of Findings

This report relates the results obtained from the second comparison of concrete rheometers. It was carried out in Cleveland (OH, USA) in May 2003. The first comparison was held in France in October 2003 and the results are reported in Ref. [3].

A series of 23 mixtures was tested in five rheometers, two of which had the same design (IBB and IBB portable). Seventeen mixtures were concrete and five were mortars (no coarse aggregates added). The mixtures had slumps ranging from 121 mm to 248 mm, with some of the concrete being SCC. The most important characteristic was that they had a wide range of combinations of yield stress and plastic viscosity. Some tests using oil, as the first attempt to develop a reference material, were also performed.

The rheometers were all rotational, but were based on different principles and had highly different geometries. They could be grouped as follows:

- Coaxial: BML, CEMAGREF-ING
- Parallel plate: BTRHEOM
- Mixing action with an impeller: IBB and Two-Point apparatus

All the rheometers mentioned above were used in this Phase II with the exception of the CEMAGREF-IMG. This rheometer, that was used in the first round-robin tests, could not be included as part of this test program, because of transportation difficulties.

It was confirmed, as shown in the first round-robin [3], that the rheometers gave different values of the Bingham constants of yield stress and plastic viscosity, even for those instruments that give these directly in fundamental units. Some conclusions also confirmed the findings of the first round-robin:

- The rank of mixtures with respect both yield stress and plastic viscosity was shown to be not independent of the rheometer used. In quite a few cases at least 3 rheometers position one mixture at the same rank.
- The degree of correlation of both yield stress and plastic viscosity measurements between any pair of rheometers was reasonably high. Relationships with 95 % confidence levels have been proposed to relate measurements with one rheometer to those with another. Nevertheless, much research is needed to obtain a good correlation function between any two rheometers. This can be seen as the correlation functions, especially for viscosity, obtained at LCPC (Phase I) and at MB (Phase II) are not the same.
- The slump test correlates well with the yield stress as measured with any of the rheometers
- All rheometers could be used to estimate the flow characteristics of concrete as based on the Bingham parameters.

Some new conclusions could also be drawn:

- The concept of relative viscosity first described in Ref. [30] could be used to compare results from rheometers that do not provide results using the same units, as the relative viscosity is independent of the geometry used.

- The measurements using oil were conducted in all rheometers with the exception of the BTHREOM. This rheometer is not designed to measure a Newtonian fluid. Although the correlation factor varied from 0.7 to 3, it could be conceived that some benefit could be found in using oil as reference material. Obviously, it is clear that a reference material should be granular in nature and cannot be pure oil.
- An attempt in determining the reproducibility of the results showed that small variation in the concrete could cause large changes in the rheometers results. This conclusion should be taken with some caution because of the limited data used for this test.

8. Resolution of Phase I Recommendations and Recommendations for Future work

This research was not able to answer some of the questions raised by the first round-robin [3], and it is the general opinion of the authors that further research in this field is warranted.

8.1. Resolution of Phase I Recommendations

Some of the tasks labeled as future work in the first round-robin were achieved in this campaign. These tasks outlined in Phase I [3] and the corresponding achievements of this test program are listed below:

- A wider range of mixtures, including self-consolidating concrete mixtures should be tested: *At least 3 mixtures prepared through this test program could qualify as SCC.*
- Concrete mixtures with a wider range of plastic viscosities should be tested: *As shown in Figure 18 and Figure 19 this was achieved by preparing mixtures with both high and low plastic viscosities.*
- A set of repetition mixtures should be prepared to give a higher level of confidence in the results: *A level of repeatability was examined through the duplication of three mixtures as shown in Section 6.3.*
- Investigate the possibility of developing a standard material for calibration of rheometers: *The use of the oil was the first attempt to develop such a material.*
- Others goal set by the first round robin were not addressed. For instance it was not possible to have two sources of aggregates (crushed and round). On the other hand these data could be used to validate some approaches to simulate the rheometers that could be in progress in some laboratories.

8.2. Recommendations for Future Work

The following items are offered as recommendations for future work:

- More research is needed to understand the phenomena, which occur in rheometers (segregation, slip, thixotropy), perturbing the rheological measurements. Once these phenomena can be modeled, it will be possible to design better rheometers, able to provide real values that can be securely used in the simulation of concrete casting.
- Numerical simulation of scale-1 concrete flow (e.g. the discharge of a 1-m³ bucket), compared with experimental results, could be explored as another way of evaluating the relevance of the various rheometers.
- The reference material issue was just approached here by using oil but it is by no means resolved. Therefore, there is a need to develop a material that could be properly characterized by independent means and that is granular in nature. Ideally,

oil with round aggregates with a distribution similar to concrete would be potentially more appropriate. The oil viscosity would be easily characterized using a well-calibrated rheometer for polymers and the influence of the addition of the aggregates could be simulated using models [35] that could provide the change of viscosity due to the aggregates. Even if the granular model suspension absolute viscosity could not be measure, such a material could provide a reference material to compare all the rheometers.

Of the research points raised above, the one that should be pursued immediately is the reference material issue. The reason is that with a reliable reference material, calibration of the rheometers could be seriously considered. As a first step, it is possible that the oil used in this report could be satisfactory as the medium of a reference material. Also the same manufacturer produces oils with lower and higher viscosities, if needed. But, the question not yet answered is the source of the aggregates. The performances required by the mixture are: aggregates and oil mixtures should be mixable using conventional mixers; no significant sedimentation of the aggregates between mixing and during the measurements should occur. Some ideas on aggregates characteristics could be: spherical, same specific gravity as the oil (about 1) to avoid sedimentation, manufactured (constant supply), and cheap and available in various sizes.

Using the grant available from ACI-CRC, a large quantity of an oil was purchased and an experimental plan is under discussion to distribute and test the oil in the concrete rheometers with and without aggregates. The rheometers that could participate in this third round-robin are those presented here, but also others that were not present at Phase II.

Finally, the authors of this report are launching a call for any suggestion for a suitable aggregate.

9. References

- 1 Hu, C., "Rhéologie des bétons fluides," Etudes et Recherches des Laboratoires des Ponts et Chaussées, OA 16, 203 p., Paris, France, 1995
- 2 Ferraris C., Brower L., Ozyildirim C., Daczko J., "Workability of Self-compacting Concrete," Symp. Proc. of PCI/FHWA/FIB Int. Symposium on 'High Performance Concrete: The Economical Solution for Durable Bridges and Transportation Structures," Orlando (FL) Sept 25-27, pp. 398-407, 2000
- 3 Ferraris, C.F., and Brower, L.E. (Eds.). (2001). *Comparison of concrete rheometers: International tests at LCPC (Nantes, France) in October 2000*, (NISTIR 6819). Gaithersburg, MD. National Institute of Standards and Technology.
- 4 Ferraris, C.F., "Measurement of the Rheological Properties of High Performance Concrete: State of the Art Report," Journal of Research of NIST, vol. 104 #5, pp. 461-478, 1999
- 5 Hackley V. A., Ferraris C. F., "Guide to Rheological Nomenclature: Measurements in Ceramic Particulate Systems," NIST Special Publication 946, February 2001
- 6 Wallevik O.H., "The Rheology of Fresh Concrete and its Application on Concrete with and without Silica Fume," Dr.ing. thesis 1990:45, NTH Trondheim, p. 185 (in Norwegian), 1990
- 7 Wallevik O.H., Gjorv, O.E., "Development of a Coaxial Cylinder Viscometer for Fresh Concrete," Properties of Fresh Concrete, proceedings of the Rilem Colloquium, Chapman & Hall, Hanover, October, 1990, pp. 213-224
- 8 de Larrard, F., Szitkar J.-C., Hu, C., Joly M., "Design of a Rheometer for Fluid Concretes," RILEM Workshop Special Concretes – Workability and Mixing, 201-208, 1993
- 9 de Larrard, F., Sedran, T., Hu, C., Szitkar, J.C., Joly, M., Derkx, F., "Evolution of the Workability of Superplasticized Concretes: assessment with BTRHEOM Rheometer," RILEM International Conference on Production Methods and Workability of Concrete, RILEM Proceedings 32, Glasgow, Scotland, June 3-5, pp. 377-388, 1996.
- 10 Beaupré, D., "Rheology of High Performance Shotcrete," Ph. D. Thesis Uni. Of British Columbia (Canada), 1994
- 11 Domone P.L.J., Xu Yongmo, Banfill P.F.G., "Developments of the Two-Point Workability Test for High-Performance Concrete," Magazine of Concrete Research, vol. 51, pp. 181-190, 1999
- 12 Szecsy R E, "Concrete Rheology," Ph.D thesis, University of Illinois at Urbana Champaign, pp. 84-86, pp 205-209, 1997

- 13 Struble L, Puri U, and Ji X, "Concrete Rheometer," *Advances in Cement Research* 13(2) 53-63 (2001).
- 14 Powers, T.C. *Properties of Fresh Concrete*. New York: John Wiley & Sons, 1968
- 15 Leivo, M., "Rheological Modeling of the Compaction Properties of Concrete," H.-J. Wierig, Ed., *Properties of Fresh Concrete, Proc. of the Coll. RILEM*, Chapman and Hall, 277-285, 1990
- 16 "Interim Guidelines for the Use of Self-Consolidating Concrete in Precast/Prestressed Concrete," Institute Member Plants, TR-6-03, Precast/Prestressed Concrete Institute, 2003
- 17 "Recommendation for Construction of Self-Compacting Concrete", Japan Society of Civil Engineers, 1998
- 18 Tattersall, G.H., Banfill, P.F.G., *The Rheology of Fresh Concrete*, Pitman Advanced Publishing Program, 1983
- 19 Wallevik O.H., *The Rheology of Fresh Concrete and its Application on Concrete with and without Silica Fume*, Dr.ing. thesis 1990:45, NTH Trondheim. p.185 (in Norwegian), 1990
- 20 Wallevik O.H., Gjorv, O.E., "Development of a Coaxial Cylinder Viscometer for Fresh Concrete," *Properties of Fresh Concrete, proceedings of the Rilem Colloquium*, Chapman & Hall, Hanover, October, pp. 213-224, 1990
- 21 Wallevik, J. E. "Rheology of Particle Suspensions; Fresh Concrete, Mortar and Cement Paste with Various Types of Lignosulfonates" (Ph.D.-thesis), Department of Structural Engineering, The Norwegian University of Science and Technology, pp.65-69, pp.195-204, 2003
- 22 Wallevik, J. E., "Rheological Measurements on a High Yield Value Bingham Fluid with Low Agitation," *Annual Transactions of the Nordic Rheology Society*, Friis, A. and Mason, S. L. (editors), Volume 9, Trondheim, Norway, pp.39-44, 2001
- 23 de Larrard, F., Hu, C., Sedran, T., Szitkar, J.C., Joly, M., Claux, F., and Derkx, F., "A New Rheometer for Soft-to-Fluid Fresh Concrete," *ACI Materials Journal*, 94(3), 234-243, 1997
- 24 de Larrard, F., Szitkar, J. C., Hu, C., Joly, M., "Design of a Rheometer for Fluid Concretes," P.J.M. Bartos, Ed., *Proceedings, Special Concretes: Workability and Mixing*, Paisley, Scotland: RILEM, 201-208, 1993
- 25 Hu, C., deLarrard, F., Sedran, T., Bonlag, C., Bose, F., and Deflorenne, F., "Validation of BTRHEOM, the New Rheometer for Soft-to-fluid Concrete," *Materials and Structures*, 29(194), 620-631, 1996
- 26 Tattersall, G.H., *The workability of concrete*, A Viewpoint Publication, Cement and Concrete Association, 1976

- 27 Beaupré, D., “Rheology of High Performance Shotcrete”, Ph. D. Thesis Uni. Of British Columbia (Canada), 1994
- 28 Tattersall GH, Bloomer SJ, “Further Development of the Two-point Test for Workability and Extension of its Range,” Magazine of Concrete Research 31: 202-210,1979
- 29 Domone PLJ, Xu Y, Banfill PFG, “Developments of the Two-point Workability Test for High-performance Concrete,” Magazine of Concrete Research 51: 171-179, 1999
- 30 Chiara F. Ferraris, Mette Geiker, Nicos S. Martys and Nicholas Muzzatti, “Calibration of modified parallel-plate rheometer for measurement of suspensions with a wide range of particle size”, to be submitted for publication
- 31 Private e-mail from Francois de Larrard and Thierry Sedran, 2004
- 32 Kendall, M.G., *Rank Correlation Methods*, Griffin, London, 1955
- 33 C. F. Ferraris, N. S. Martys, “Relating Fresh Concrete Viscosity Measurements from Different Rheometers,” J. Res. Natl. Inst. Stand. Technol. 108, 2003
- 34 Hackley V. A, Ferraris C.F., "The Use of Nomenclature in Dispersion Science and Technology" NIST Recommended Practice Guide, SP 960-3, 2001
- 35 Bullard J.W, Ferraris C.F., Garboczi E.J., Martys N., Stutzman P., “ Virtual Cement,” Chapt 10.3 from “Innovations in Portland Cement Manufacturing”, Ed. J.I. Bhatti, F.M. Miller, S.H. Kosmatka, PCA – CD-ROM, pp. 1311-1331, 2004

Table of content

<u>Appendix A: Data from the Rheometers</u>	3
<u>DATA AND GRAPHS FROM THE BML</u>	3
<u>DATA AND GRAPHS FROM THE BTRHEOM</u>	9
<u>DATA AND GRAPHS FROM THE IBB</u>	20
<u>DATA AND GRAPH FROM THE IBB PORTABLE</u>	26
<u>DATA AND GRAPH FROM THE TWO-POINT TEST</u>	32
<u>DATA AND GRAPH FROM THE UIUC RHEOMETER</u>	38

Disclaimer

The policy of the National Institute of Standards and Technology (NIST) is to use the International System of Units (metric units) in its publications. This Appendix reproduces reports written by the participants in the International tests in MBT. In some instances, the use of the measurements units in these participants' reports is not in full accordance with NIST policy on SI Units. The copy in this appendix is reprinted in its original format to preserve the integrity of the participants' reports.

Appendix A: Data from the Rheometers

DATA AND GRAPHS FROM THE BML

Day 1, concrete

BLM-D1M3C - Concrete

Torque (Nm)	Speed (rev/sec)	
4,016	0,08	1
4,112	0,14	0
4,464	0,21	0
4,665	0,27	0
4,996	0,33	0
5,252	0,39	0
5,689	0,44	0

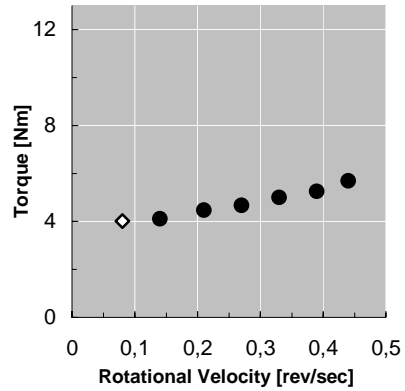

BLM-D1M4C - Concrete

Torque (Nm)	Speed (rev/sec)	
5,426	0,08	1
5,757	0,14	0
6,291	0,21	0
6,834	0,27	0
7,164	0,33	0
7,836	0,39	0
8,506	0,44	0

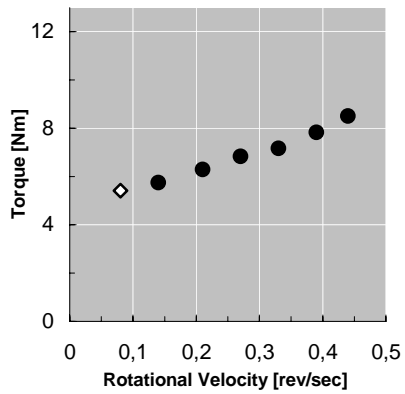

BLM-D1M4C - Concrete

Torque (Nm)	Speed (rev/sec)	
8,138	0,08	1
8,833	0,14	0
8,664	0,2	0
9,16	0,27	0
9,604	0,33	0
10,222	0,39	0
10,62	0,44	0

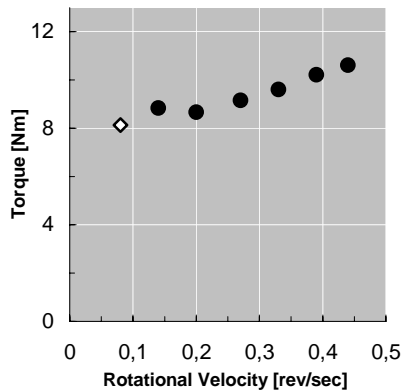

Day 2, concrete

BLM-D2M1C - Concrete

Torque (Nm)	Speed (rev/sec)	
9,351	0,08	0
9,901	0,14	0
10,076	0,21	0
10,147	0,27	0
11,054	0,33	0
11,837	0,39	0
12,201	0,44	0

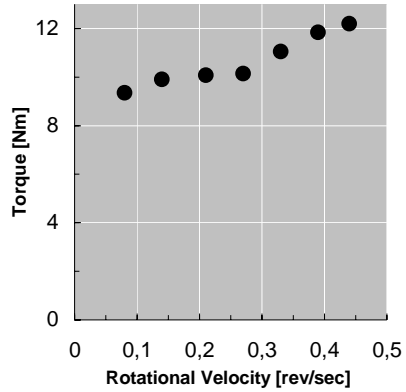

BLM-D2M2C - Concrete

Torque (Nm)	Speed (rev/sec)	
1,148	0,08	1
1,325	0,14	0
1,563	0,2	0
1,819	0,27	0
2,12	0,33	0
2,442	0,39	0
2,819	0,44	0

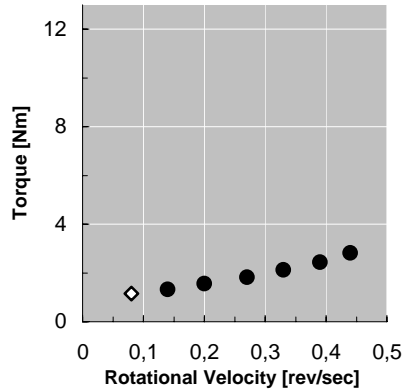

BLM-D2M3C - Concrete

Torque (Nm)	Speed (rev/sec)	
1,328	0,08	0
2,185	0,14	0
3,006	0,21	0
3,92	0,27	0
5,005	0,33	1
6,052	0,39	1
7,967	0,45	1

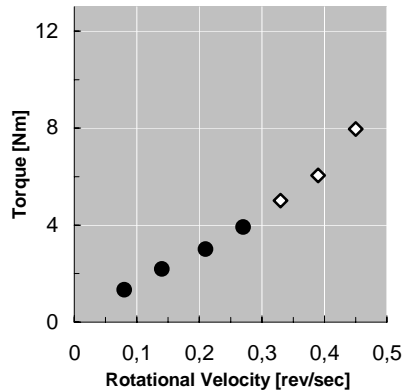

BLM-D2M4C - Concrete

Torque (Nm)	Speed (rev/sec)	
1,383	0,08	1
1,891	0,14	0
2,323	0,21	0
2,884	0,27	0
3,454	0,33	0
4,101	0,39	0
4,965	0,44	1

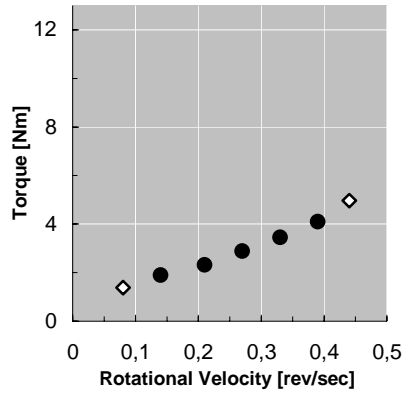

BLM-D2M5C - Concrete

Torque (Nm)	Speed (rev/sec)	
2,289	0,08	1
3,056	0,14	0
3,912	0,2	0
4,681	0,27	0
5,618	0,33	0
6,613	0,39	0
8,071	0,44	1

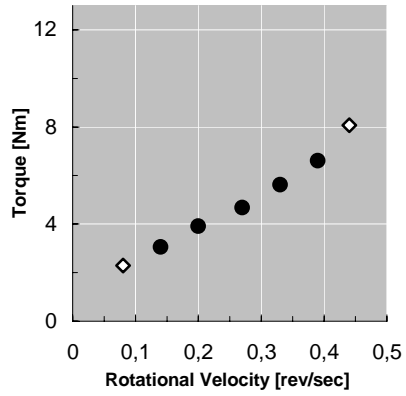

BLM-D2M7C - Concrete

Torque (Nm)	Speed (rev/sec)	
2,025	0,08	1
2,777	0,14	0
3,544	0,2	0
4,137	0,27	0
5,063	0,33	0
6,214	0,39	0
7,27	0,44	1

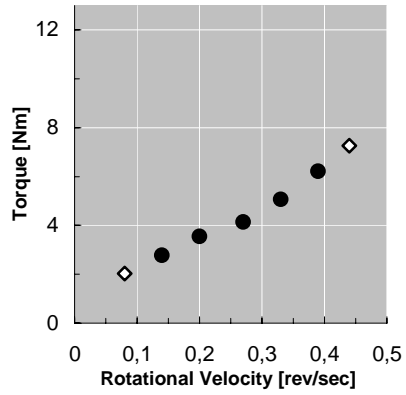

Day 2, mortar

BLM-D2M1M - Mortar

Torque (Nm)	Speed (rev/sec)
3,256	0,08
3,276	0,14
3,308	0,21
3,34	0,27
3,383	0,33
3,407	0,39
3,443	0,44

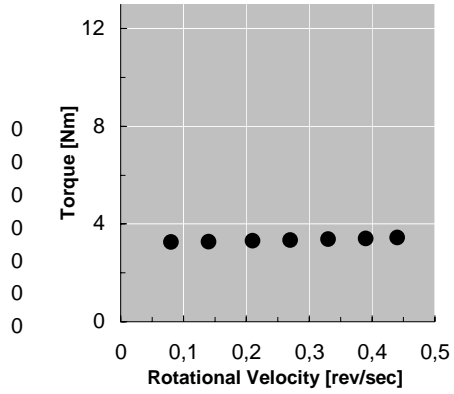

BLM-D2M5M - Mortar

Torque (Nm)	Speed (rev/sec)
4,043	0,08
4,314	0,14
4,553	0,2
4,781	0,27
5,016	0,33
5,232	0,39
5,474	0,44

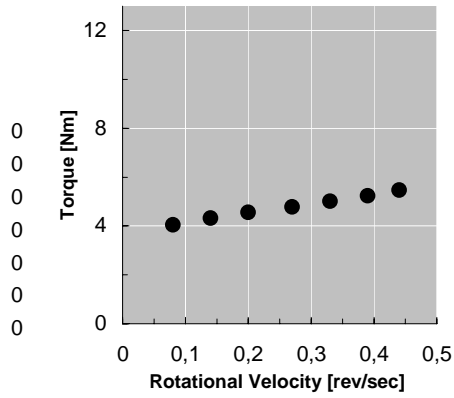

BLM-D2M6M - Mortar

Torque (Nm)	Speed (rev/sec)
0,324	0,08
0,413	0,14
0,491	0,21
0,564	0,27
0,647	0,33
0,731	0,39
0,835	0,44

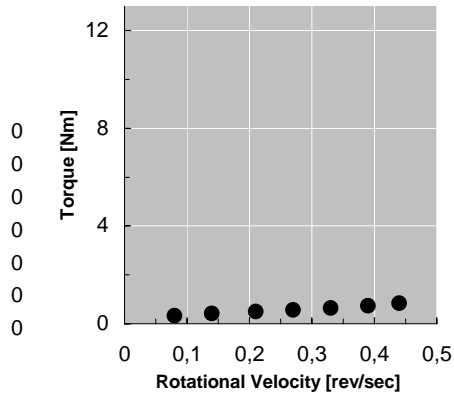

Day 3, concrete

BLM-D3M4C - Concrete

Torque (Nm)	Speed (rev/sec)
4,825	0,08
5,156	0,14
5,359	0,21
5,73	0,27
6,151	0,33
6,565	0,39
7,267	0,44

0
0
0
0
0
0
1

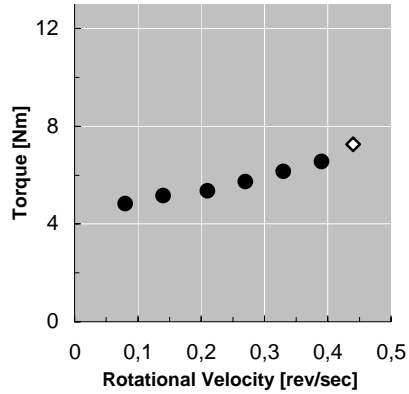

BLM-D3M5C - Concrete

Torque (Nm)	Speed (rev/sec)
1,781	0,08
2,486	0,14
3,024	0,2
3,436	0,27
4,322	0,33
5,039	0,39
6,093	0,44

0
0
0
0
0
0
1

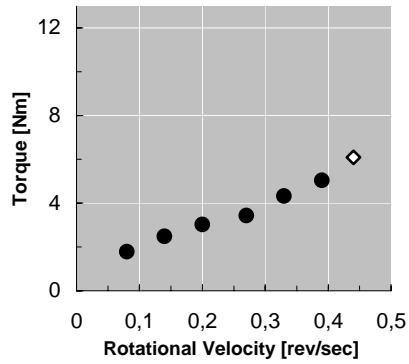

BLM-D3M6C - Concrete

Torque (Nm)	Speed (rev/sec)
4,621	0,08
5,069	0,14
5,781	0,2
6,286	0,27
7,033	0,33
7,654	0,39
8,511	0,44

0
0
0
0
0
0
1

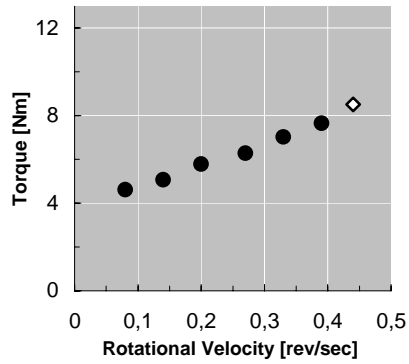

Day 3, oil

BLM-D30 - Oil test 1

Torque (Nm)	Speed (rev/sec)
0,67	0,08
1,04	0,14
1,41	0,20
1,78	0,27
2,15	0,33
2,51	0,39
2,84	0,44

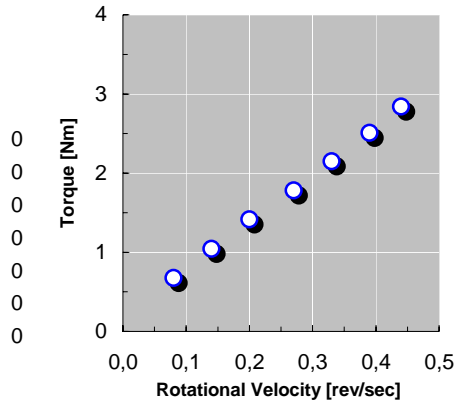

BLM-D30 - Oil test 2

Torque (Nm)	Speed (rev/sec)
0,67	0,08
1,05	0,14
1,42	0,20
1,79	0,27
2,15	0,33
2,52	0,39
2,85	0,44

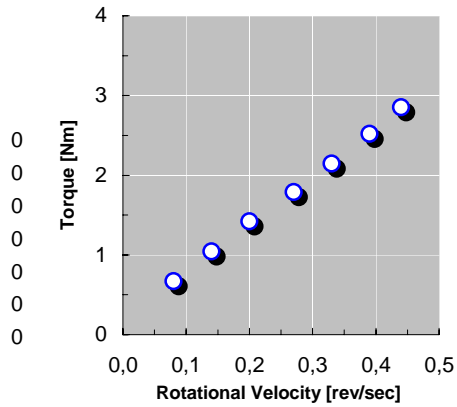

BLM-D30 - Oil test 3

Torque (Nm)	Speed (rev/sec)
0,67	0,08
1,04	0,14
1,42	0,20
1,79	0,27
2,16	0,33
2,52	0,39
2,85	0,44

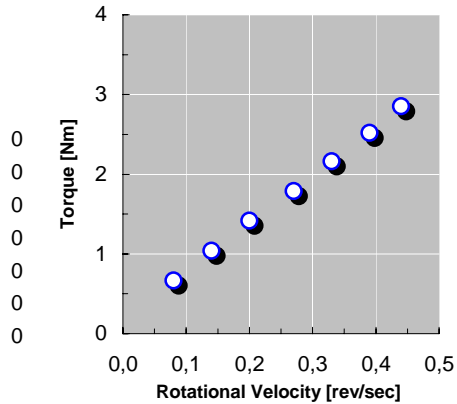

DATA AND GRAPHS FROM THE BTRHEOM

Concrete Mixtures

Mixture BTRD1M2-Concrete

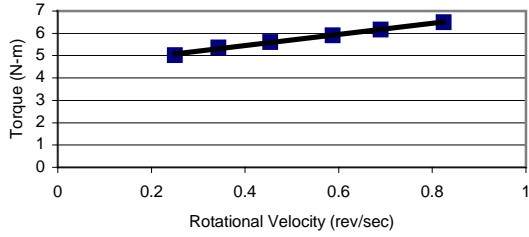

Mixture BTRD1M4-Concrete

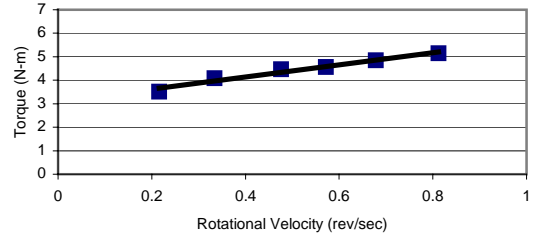

Mixture BTRD1M3-Concrete

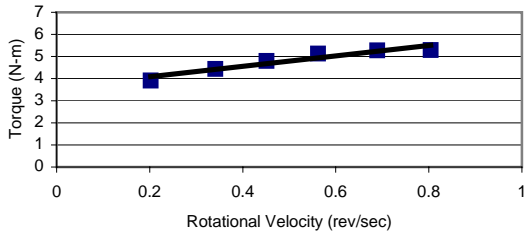

Mixture BTRD1M5-Concrete

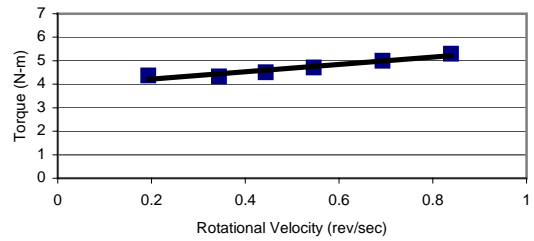

Mixture BTRD2M1-Concrete

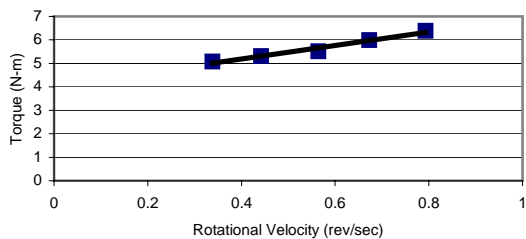

Mixture BTRD2M3-Concrete

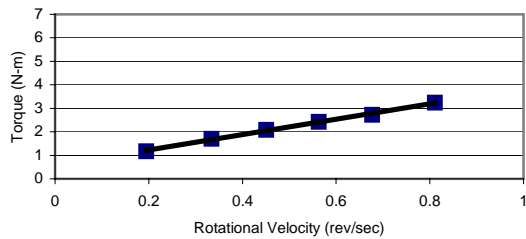

Mixture BTRD2M2-Concrete

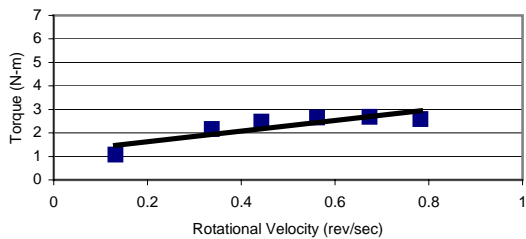

Mixture BTRD2M4-Concrete

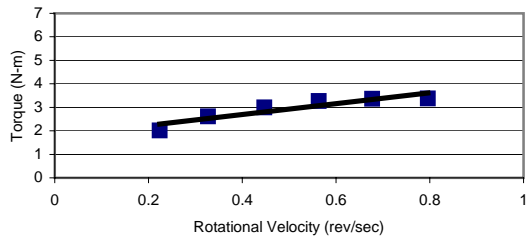

Mixture BTRD2M5-Concrete

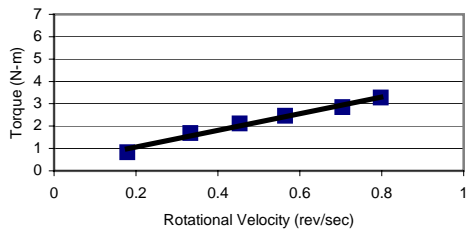

Mixture BTRD3M1-Concrete

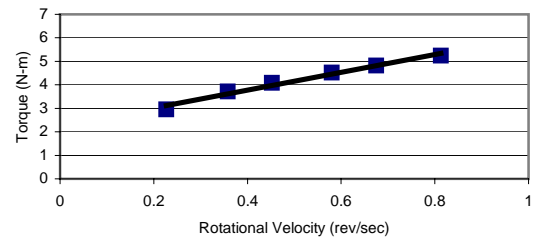

Mixture BTRD2M7-Concrete

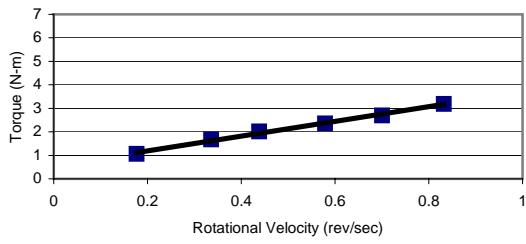

Mixture BTRD3M2-Concrete

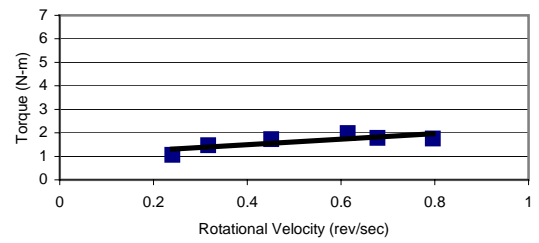

Mixture BTRD3M3-Concrete

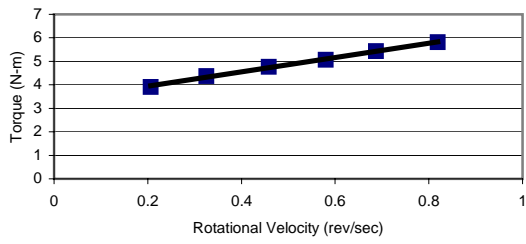

Mixture BTRD3M5-Concrete

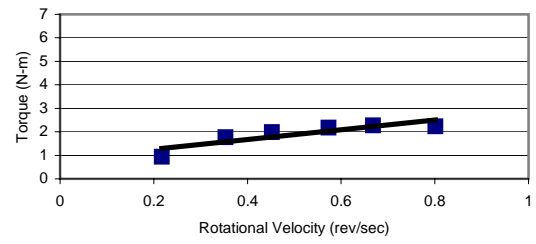

Mixture BTRD3M4-Concrete

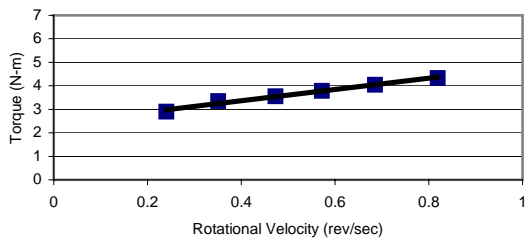

Mixture BTRD3M6-Concrete

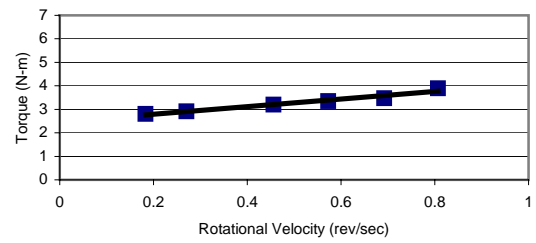

Mortar Mixtures

Mixture BTRD1M1-Mortar

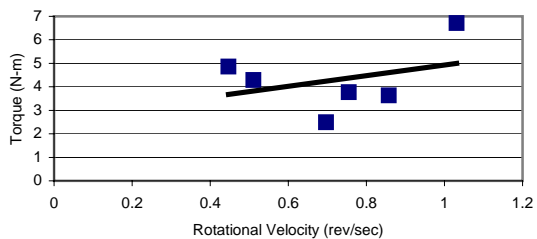

Mixture BTRD1M2-Mortar (Close-up)

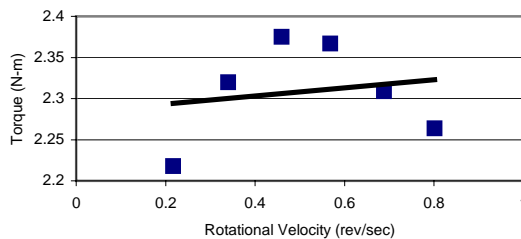

Mixture BTRD1M1-Mortar (2nd test)

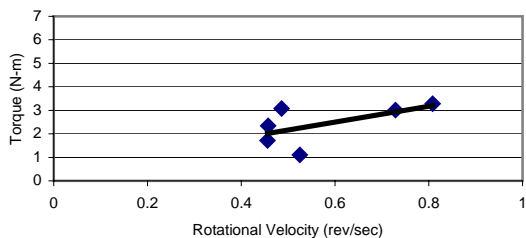

Mixture BTRD2M1-Mortar

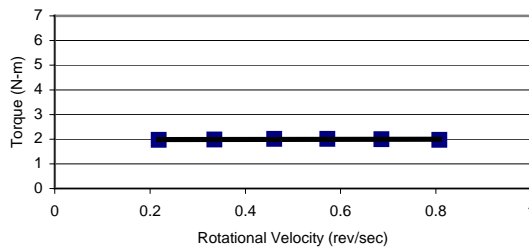

Mixture BTRD1M2-Mortar

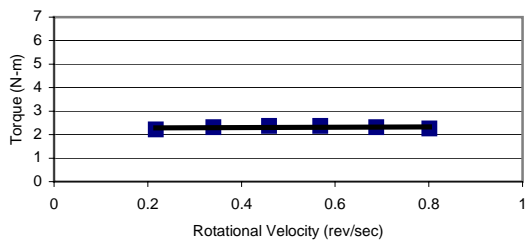

Mixture BTRD2M1-Mortar (Close-up)

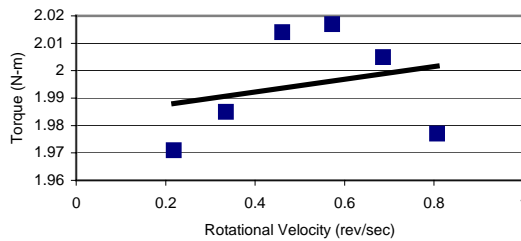

Mixture BTRD2M5-Mortar

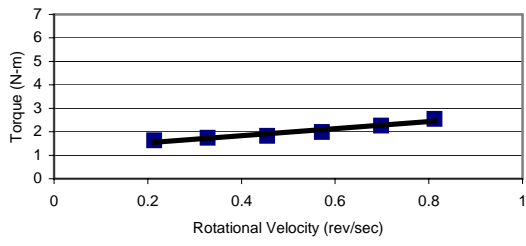

Mixture BTRD2M6-Mortar

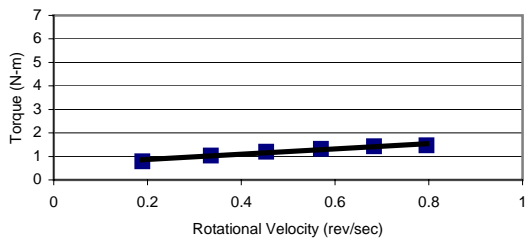

Oil

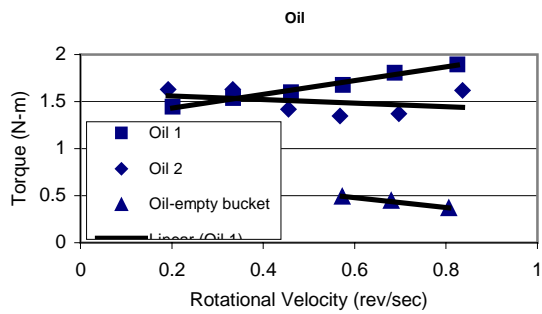

Concrete Mixtures

BTRD1M1C2.tst - Concrete	
Speed (rev/sec)	Torque (N-m)
No Results	

BTRD1M2C2.tst - Concrete	
Speed (rev/sec)	Torque (N-m)
0.824	6.502
0.69	6.163
0.587	5.909
0.454	5.604
0.343	5.363
0.25	5.02
0	5.19

BTRD1M3C2.tst - Concrete	
Speed (rev/sec)	Torque (N-m)
0.804	5.29
0.689	5.277
0.562	5.133
0.451	4.802
0.341	4.441
0.202	3.915
0.188	3.477

BTRD1M4C2.tst - Concrete	
Speed (rev/sec)	Torque (N-m)
0.812	5.153
0.678	4.855
0.572	4.565
0.476	4.464
0.334	4.089
0.216	3.52
0.192	3.519

BTRD1M5C2.tst - Concrete	
Speed (rev/sec)	Torque (N-m)
0.839	5.303
0.693	4.994
0.546	4.716
0.444	4.514
0.344	4.334
0.193	4.365
0.167	4.379

BTRD2M1C2.tst - Concrete	
Speed (rev/sec)	Torque (N-m)
0.793	6.385
0.673	5.989
0.564	5.518
0.442	5.314
0.338	5.076
0	5.974
0.457	4.911

* Point 6 is nonsense and was discounted for analysis

BTRD2M2C2.tst - Concrete	
Speed (rev/sec)	Torque (N-m)
0.782	2.592
0.674	2.68
0.562	2.656
0.443	2.481
0.337	2.17
0.132	1.074
0.107	0.636

BTRD2M3C2.tst - Concrete	
Speed (rev/sec)	Torque (N-m)
0.811	3.237
0.677	2.727
0.563	2.428
0.451	2.08
0.334	1.707
0.195	1.173
0.251	-0.024

BTRD2M4C2.tst - Concrete	
Speed (rev/sec)	Torque (N-m)
0.796	3.377
0.677	3.368
0.563	3.268
0.447	3
0.327	2.609
0.224	2.01
0.249	1.349

BTRD2M5C2.tst - Concrete	
Speed (rev/sec)	Torque (N-m)
0.798	3.272
0.704	2.855
0.564	2.456
0.453	2.114
0.333	1.686
0.179	0.833
0.176	0.577

BTRD2M7C2.tst - Concrete	
Speed (rev/sec)	Torque (N-m)
0.832	3.192
0.7	2.697
0.579	2.362
0.438	2.01
0.336	1.672
0.177	1.061
0.291	0.576

BTRD3M1C2.tst - Concrete	
Speed (rev/sec)	Torque (N-m)
0.813	5.246
0.675	4.818
0.58	4.52
0.452	4.092
0.358	3.722
0.227	2.952
0.308	2.736

BTRD3M2C2.tst - Concrete	
Speed (rev/sec)	Torque (N-m)
0.796	1.762
0.678	1.784
0.614	1.985
0.451	1.732
0.317	1.475
0.24	1.059
0.213	0.896

BTRD3M3C2-2.tst - Concrete	
Speed (rev/sec)	Torque (N-m)
0.819	5.813
0.687	5.43
0.58	5.063
0.458	4.762
0.325	4.369
0.206	3.909
0.747	2.969

* Test was restarted after about 2 minutes

BTRD3M4C2.tst - Concrete	
Speed (rev/sec)	Torque (N-m)
0.819	4.336
0.685	4.048
0.572	3.791
0.473	3.56
0.351	3.346
0.24	2.895
0.266	2.449

BTRD3M5C2.tst - Concrete	
Speed (rev/sec)	Torque (N-m)
0.801	2.23
0.668	2.281
0.573	2.184
0.452	1.985
0.353	1.776
0.217	0.936
0.204	0.848

BTRD3M6C2.tst - Concrete	
Speed (rev/sec)	Torque (N-m)
0.807	3.9
0.692	3.471
0.573	3.356
0.456	3.197
0.27	2.916
0.183	2.807
0.156	2.606

Mortar Mixtures

BTRD1M1M2.tst - Mortar	
Speed (rev/sec)	Torque (N-m)
1.031	6.711
0.697	2.486
0.755	3.768
0.857	3.641
0.511	4.289
0.447	4.859
0	4.023

* Could not attain a proper Bingham relationship

BTRD1M1M2.tst - 2nd mort tst	
Speed (rev/sec)	Torque (N-m)
0.808	3.287
0.729	3.013
0.486	3.08
0.457	2.337
0.456	1.716
0.525	1.105
0.412	0.709

* Could not attain a proper Bingham relationship

BTRD1M2M2.tst - Mortar	
Speed (rev/sec)	Torque (N-m)
0.801	2.264
0.688	2.309
0.568	2.367
0.459	2.375
0.34	2.32
0.217	2.218
0.41	2.058

* Could not attain a proper Bingham relationship

BTRD2M1M2.tst - Mortar	
Speed (rev/sec)	Torque (N-m)
0.807	1.977
0.686	2.005
0.572	2.017
0.461	2.014
0.335	1.985
0.218	1.971
0.14	2.057

BTRD2M5M2.tst - Mortar	
Speed (rev/sec)	Torque (N-m)
0.812	2.557
0.698	2.26
0.572	1.998
0.455	1.825
0.328	1.75
0.214	1.641
0.074	1.567

BTRD2M6M2.tst - Mortar	
Speed (rev/sec)	Torque (N-m)
0.795	1.471
0.683	1.431
0.57	1.325
0.453	1.198
0.335	1.041
0.189	0.788
0.221	0.505

Oil

Oil 1 (oil2.tst)	
Speed (rev/sec)	Torque (N-m)
0.825	1.894
0.688	1.807
0.574	1.676
0.461	1.6
0.334	1.539
0.202	1.445
0.554	1.331

Oil 2 (oil3.tst)	
Speed (rev/sec)	Torque (N-m)
0.836	1.619
0.697	1.37
0.568	1.346
0.455	1.417
0.333	1.629
0.192	1.628
0.202	1.571

Oil (oil5-empty.tst)	
Speed (rev/sec)	Torque (N-m)
0.806	0.367
0.68	0.444
0.573	0.489

* Test completed after oil was removed

BTRHEOM: Summary of Mixtures & Results

Mixture Reference	¹ Average Seal Test Mean Friction	Torque vs. Rot. Velocity Bingham Regression Results			Bingham Parameters		Comments
		g (N-m)	h (N-m-s)	r ²	Shear Stress	Viscosity	
					τ_o (Pa)	μ (Pa-s)	
Concrete							
BTRD1M1C	3.106						No results – concrete too stiff
BTRD1M2C	6.467	4.451	2.495	0.995	1235	110	Manually assisted movement
BTRD1M3C	5.075	3.622	2.338	0.991	1005	103	
BTRD1M4C	6.244	3.112	2.583	0.967	864	114	
BTRD1M5C	3.374	3.905	1.569	0.927	1084	69	
BTRD2M1C	4.479	4.034	2.887	0.974	1120	127	Manually assisted movement; Based on 5 data pts
BTRD2M2C	6.076	1.168	2.269	0.751	324	100	
BTRD2M3C	5.984	0.579	3.258	0.997	161	143	
BTRD2M4C	5.768	1.767	2.317	0.852	491	102	
BTRD2M5C	8.223	0.318	3.731	0.984	88	164	Manually assisted movement
BTRD2M7C	3.763	0.569	3.128	0.994	158	138	
BTRD3M1C	6.689	2.264	3.790	0.980	628	167	Vibration used; vibration malfunction; test restarted ²
BTRD3M2C	6.348	1.019	1.189	0.628	283	52	Segregation witnessed in concrete
BTRD3M3C	6.873	3.332	3.043	0.997	925	134	Vibration used; vibration malfunction; test restarted ³
BTRD3M4C	6.252	2.414	2.385	0.986	670	105	Vibration malfunction ⁴
BTRD3M5C	6.753	0.841	2.071	0.758	233	91	
BTRD3M6C	4.476	2.474	1.610	0.958	687	71	Vibrated manually; manually assisted movement
Mortar							
BTRD1M1M	5.19	2.673	2.261	0.119	742	100	No proper relationship
BTRD1M1M		0.473	3.381	0.353	131	149	BTRD1M1M retest; no proper relationship ⁵
BTRD1M2M	6.268	2.284	0.049	0.032	634	2	No proper relationship
BTRD2M1M	6.724	1.983	0.023	0.067	550	1	No proper relationship
BTRD2M5M	3.560	1.241	1.489	0.939	345	66	Lumps in mortar
BTRD2M6M	4.924	0.637	1.134	0.960	177	50	“Soupy” mortar with balling
Oil							
Oil 1	4.911	1.286	0.727	0.986	357	32	No vibration
Oil 2		1.600	-0.191	0.1078	444	-8	Oil Retest; no vibration
Oil – Empty Bucket		0.795	-0.526	0.989	221	-23	Test completed after oil was removed

¹ Average of two tests

² Program malfunction - 30 to 40 seconds of varying vibration. Test restarted about 1 ½ minutes after initially started.

³ Program malfunction – 30 seconds of proper vibration, 30 seconds of high freq. vibration. Test restarted about 2 minutes after initially started.

⁴ Program malfunction – 30 seconds of proper vibration, 15 to 30 seconds of high freq. vibration.

⁵ A seal was dislodged during testing. This likely caused the improper relationship

DATA AND GRAPHS FROM THE IBB

Concrete Mixtures

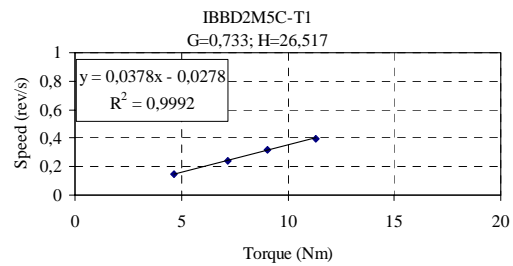
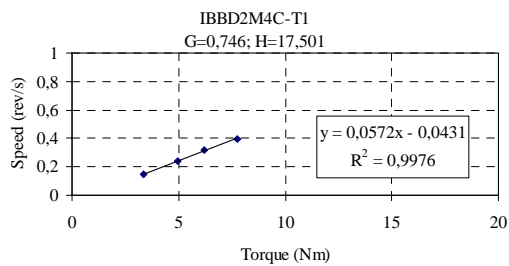
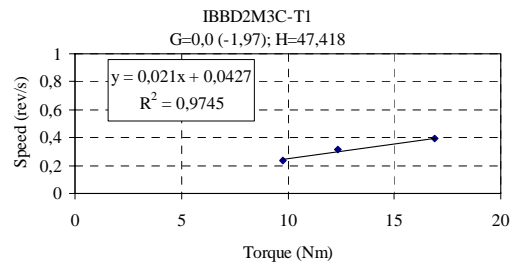
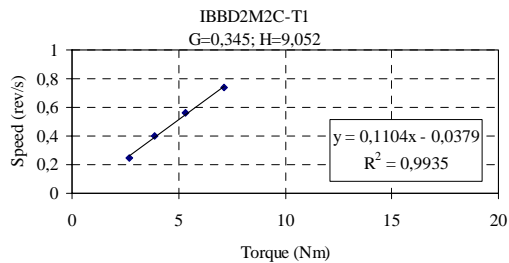
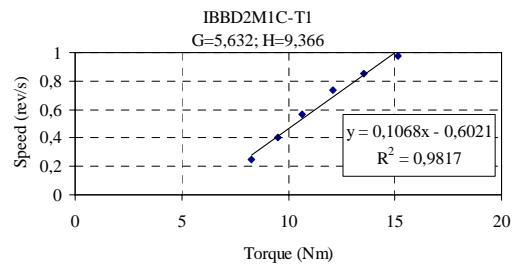
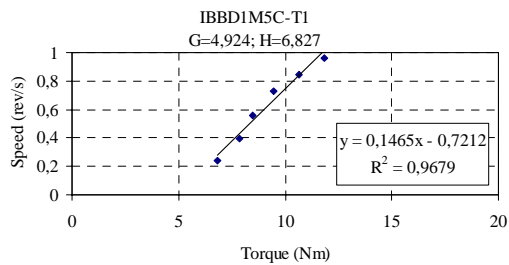
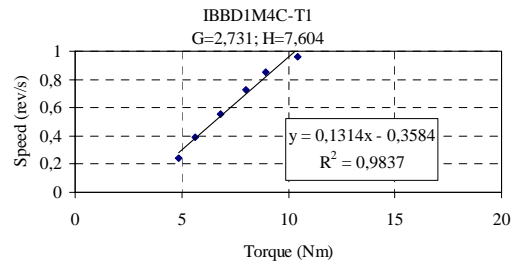
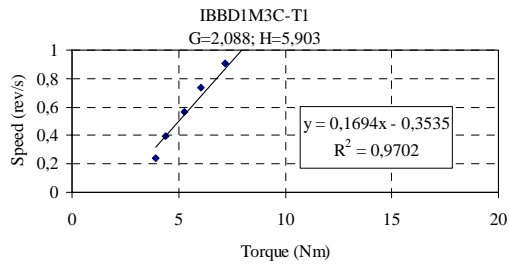
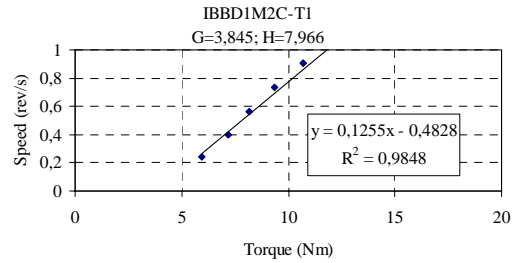
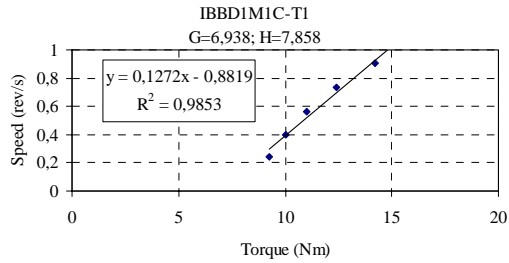

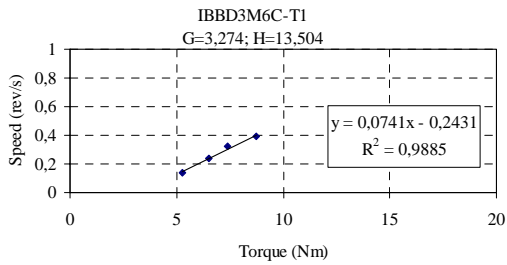
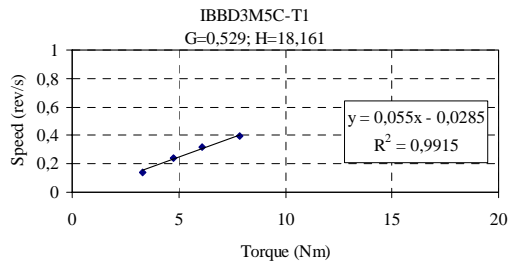
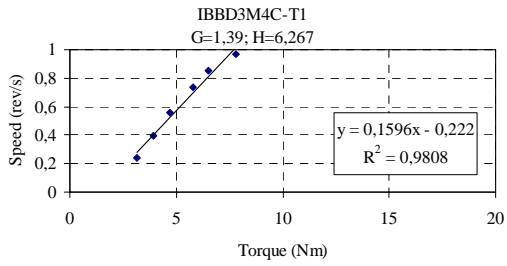
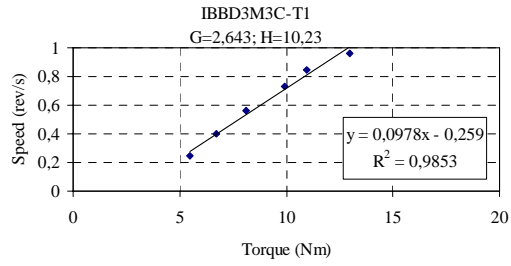
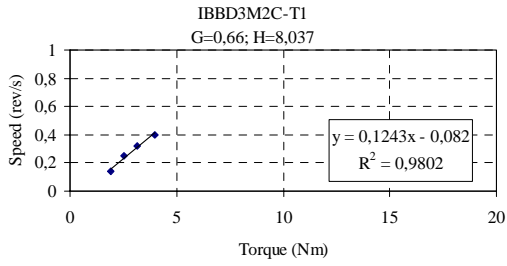
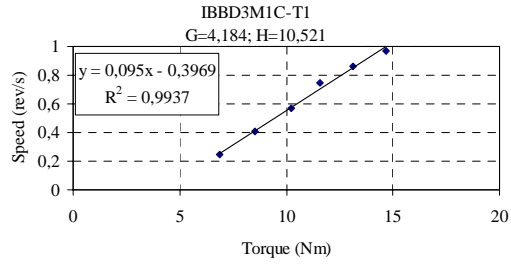
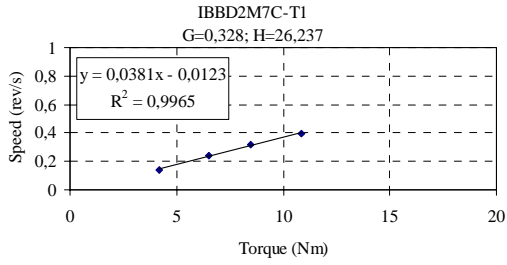

Mortar Mixtures

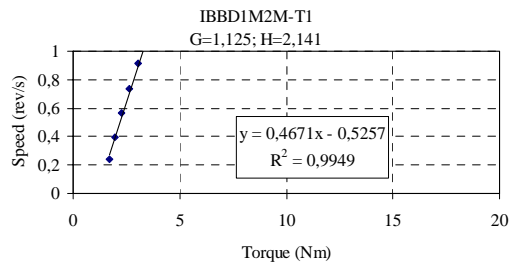
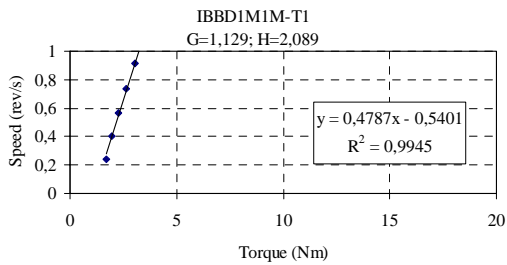

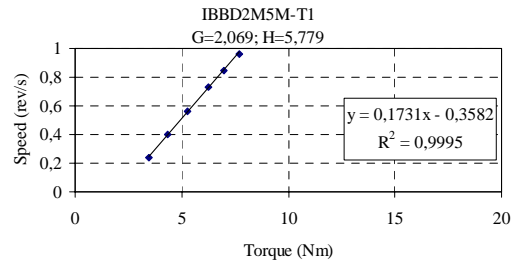
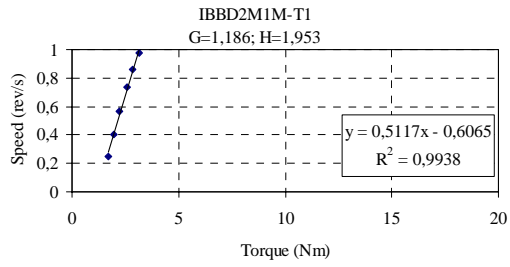

OIL

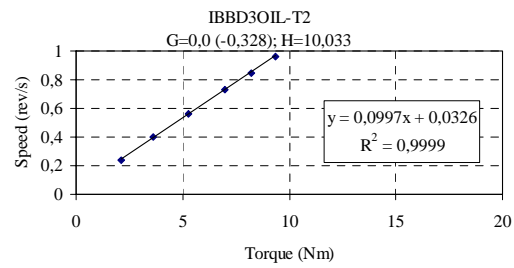
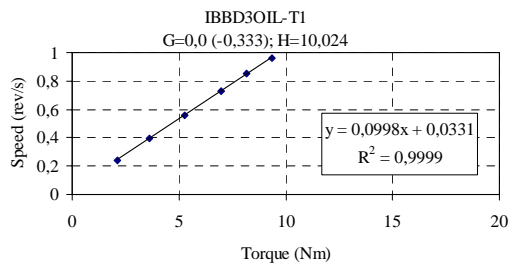

IBB Concrete mixtures Data

IBB-D1M1C	
Torque (Nm)	Speed (rev/sec)
15.66	1.09
14.19	0.91
12.41	0.74
11.03	0.56
10.00	0.40
9.28	0.24

IBB-D1M2C	
Torque (Nm)	Speed (rev/sec)
12.85	1.08
10.72	0.91
9.35	0.73
8.19	0.56
7.20	0.40
5.95	0.24

IBB-D1M3C	
Torque (Nm)	Speed (rev/sec)
8.84	1.08
7.20	0.91
6.06	0.73
5.29	0.56
4.37	0.40
3.95	0.24

IBB-D1M4C	
Torque (Nm)	Speed (rev/sec)
10.43	0.96
8.96	0.85
8.02	0.73
6.85	0.56
5.65	0.39
4.85	0.24

IBB-D1M5C	
Torque (Nm)	Speed (rev/sec)
11.85	0.96
10.63	0.85
9.45	0.73
8.45	0.56
7.87	0.40
6.81	0.24

IBB-D2M1C	
Torque (Nm)	Speed (rev/sec)
15.15	0.97
13.54	0.85
12.09	0.74
10.66	0.57
9.51	0.41
8.28	0.25

IBB-D2M2C	
Torque (Nm)	Speed (rev/sec)
7.13	0.74
5.32	0.56
3.85	0.40
2.70	0.24

IBB-D2M3C	
Torque (Nm)	Speed (rev/sec)
16.89	0.39
12.36	0.32
9.78	0.24

IBB-D2M4C	
Torque (Nm)	Speed (rev/sec)
7.73	0.40
6.18	0.32
4.97	0.24
3.35	0.15

IBB-D2M5C	
Torque (Nm)	Speed (rev/sec)
11.33	0.40
9.05	0.32
7.19	0.24
4.68	0.15

IBB-D2M7C	
Torque (Nm)	Speed (rev/sec)
10.84	0.40
8.50	0.32
6.51	0.24
4.17	0.14

IBB-D3M1C	
Torque (Nm)	Speed (rev/sec)
14.68	0.97
13.14	0.86
11.59	0.74
10.24	0.57
8.54	0.41
6.86	0.25

IBB-D3M2C	
Torque (Nm)	Speed (rev/sec)
3.99	0.40
3.13	0.32
2.55	0.25
1.94	0.14

IBB-D3M3C	
Torque (Nm)	Speed (rev/sec)
12.97	0.96
10.96	0.85
9.95	0.73
8.10	0.56
6.70	0.40
5.50	0.24

IBB-D3M4C	
Torque (Nm)	Speed (rev/sec)
7.78	0.97
6.53	0.85
5.77	0.74
4.72	0.56
3.91	0.40
3.15	0.24

IBB-D3M5C	
Torque (Nm)	Speed (rev/sec)
7.87	0.40
6.08	0.32
4.76	0.24
3.28	0.14

IBB-D3M6C	
Torque (Nm)	Speed (rev/sec)
8.73	0.39
7.37	0.32
6.53	0.24
5.27	0.14

IBB Mortar Mixtures Data

IBB-D1M1M	
Torque (Nm)	Speed (rev/sec)
3.45	1.09
3.04	0.92
2.63	0.74
2.25	0.57
1.96	0.40
1.71	0.24

IBB-D1M2M	
Torque (Nm)	Speed (rev/sec)
3.50	1.09
3.07	0.91
2.66	0.74
2.28	0.56
1.96	0.40
1.71	0.24

IBB-D2M1M	
Torque (Nm)	Speed (rev/sec)
3.14	0.97
2.86	0.86
2.59	0.74
2.24	0.57
1.96	0.40
1.73	0.25

IBB-D2M5M	
Torque (Nm)	Speed (rev/sec)
7.70	0.97
6.97	0.85
6.26	0.73
5.27	0.56
4.37	0.40
3.49	0.24

IBB-D3-OIL1	
Torque (Nm)	Speed (rev/sec)
9.37	0.96
8.15	0.85
6.98	0.73
5.27	0.56
3.63	0.40
2.12	0.24

IBB-D3-OIL2	
Torque (Nm)	Speed (rev/sec)
9.37	0.97
8.20	0.85
6.99	0.73
5.26	0.56
3.63	0.40
2.11	0.24

DATA AND GRAPH FROM THE IBB PORTABLE

Concrete Mixtures

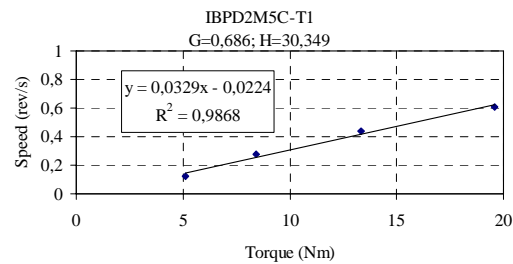
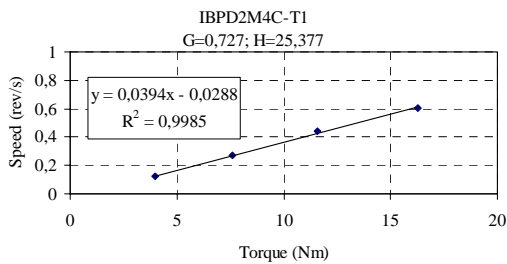
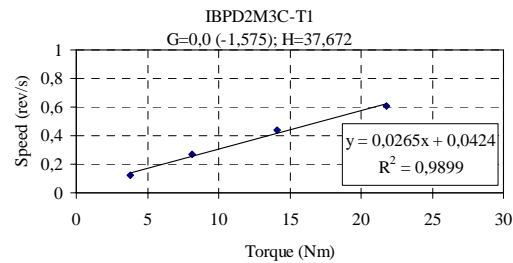
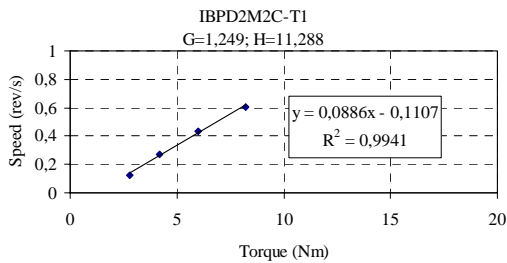
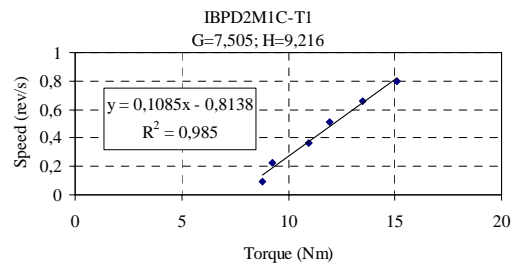
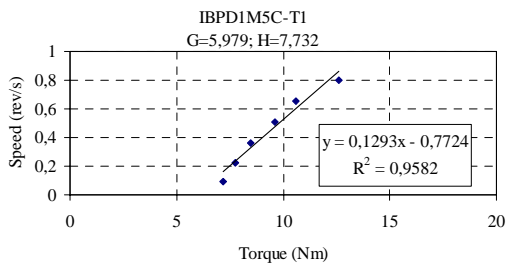
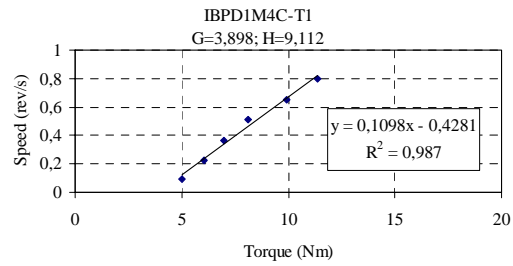
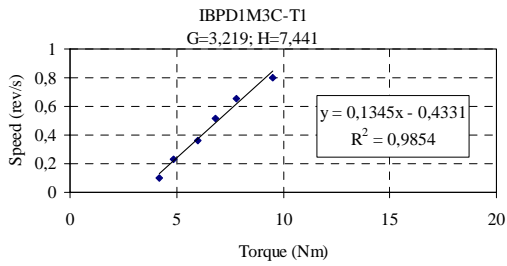
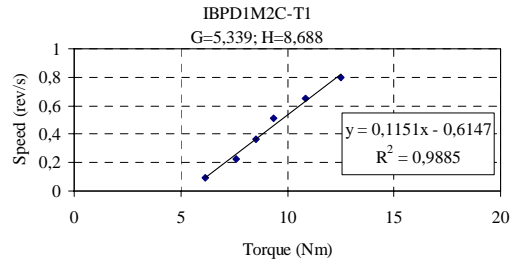
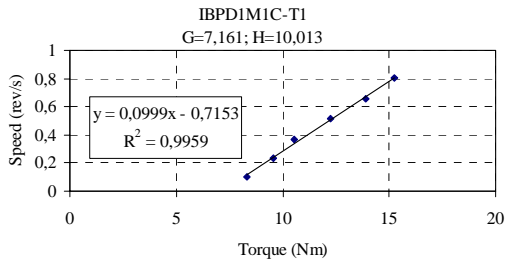

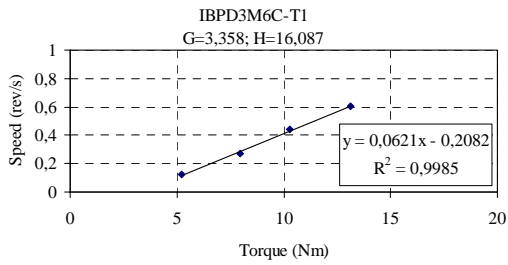
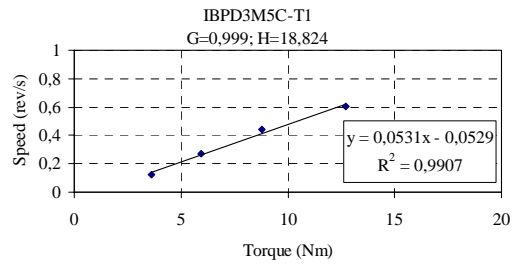
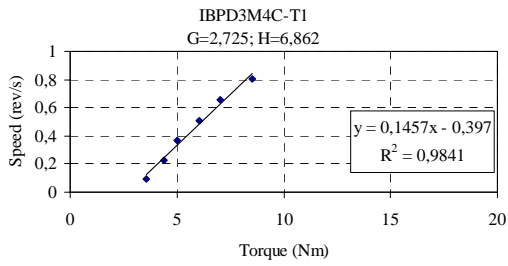
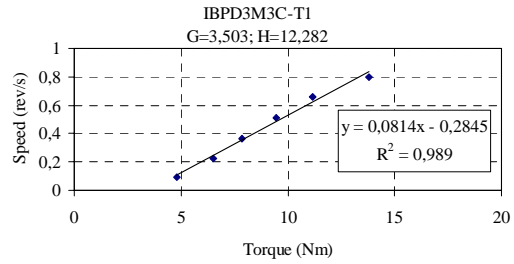
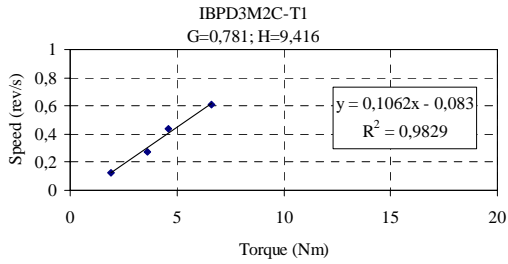
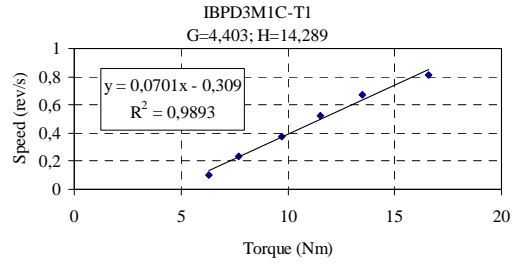
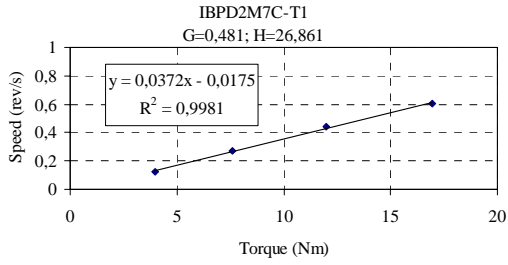

Mortar Mixtures

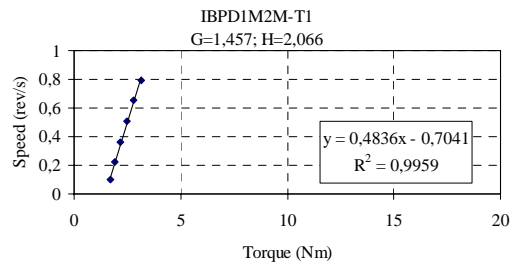
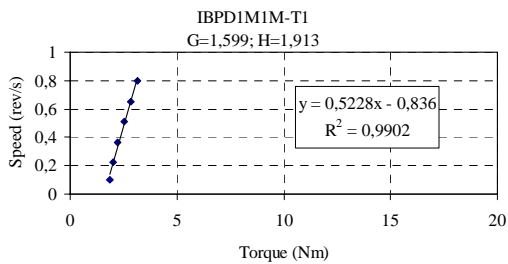

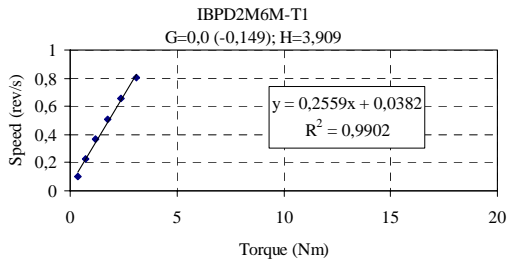
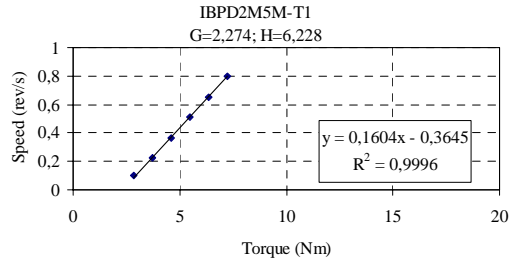
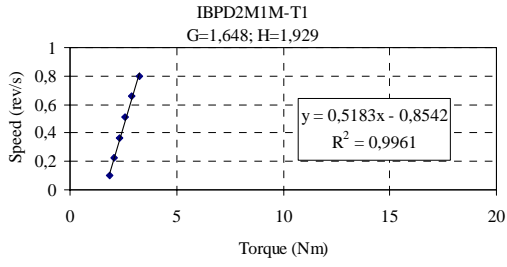

Oil

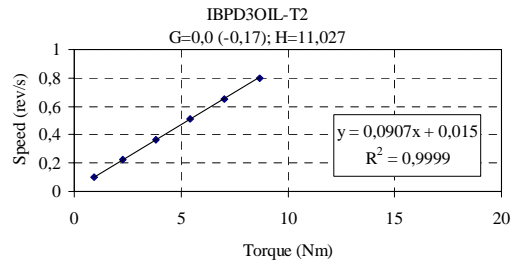
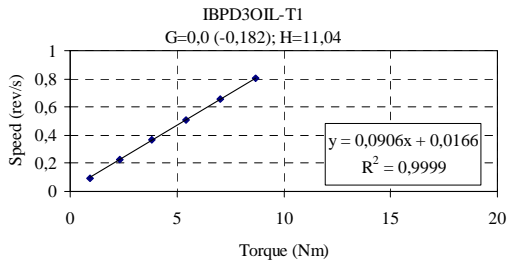

DATA

IBP-D1M1C	
Torque (Nm)	Speed (rev/sec)
15.23	0.80
13.91	0.66
12.24	0.52
10.56	0.37
9.57	0.23
8.33	0.10

IBP-D1M2C	
Torque (Nm)	Speed (rev/sec)
12.48	0.80
10.86	0.65
9.37	0.51
8.55	0.36
7.59	0.23
6.15	0.10

IBP-D1M3C	
Torque (Nm)	Speed (rev/sec)
9.49	0.80
7.81	0.66
6.81	0.51
5.98	0.37
4.84	0.23
4.18	0.10

IBP-D1M4C	
Torque (Nm)	Speed (rev/sec)
11.39	0.80
9.93	0.65
8.11	0.51
6.98	0.36
6.07	0.23
5.03	0.09

IBP-D1M5C	
Torque (Nm)	Speed (rev/sec)
12.63	0.80
10.61	0.65
9.59	0.51
8.49	0.36
7.76	0.23
7.20	0.09

IBP-D2M1C	
Torque (Nm)	Speed (rev/sec)
15.08	0.80
13.47	0.66
11.94	0.51
10.96	0.37
9.24	0.23
8.80	0.09

IBP-D2M2C	
Torque (Nm)	Speed (rev/sec)
8.21	0.61
6.02	0.44
4.17	0.27
2.80	0.12

IBP-D2M3C	
Torque (Nm)	Speed (rev/sec)
21.82	0.61
14.13	0.44
8.14	0.27
3.77	0.12

IBP-D2M4C	
Torque (Nm)	Speed (rev/sec)
16.28	0.61
11.56	0.44
7.58	0.27
3.96	0.12

IBP-D2M5C	
Torque (Nm)	Speed (rev/sec)
19.57	0.61
13.34	0.44
8.42	0.27
5.12	0.12

IBP-D2M7C	
Torque (Nm)	Speed (rev/sec)
16.95	0.61
12.01	0.44
7.61	0.27
3.98	0.12

IBP-D3M1C	
Torque (Nm)	Speed (rev/sec)
16.59	0.82
13.49	0.67
11.53	0.52
9.72	0.37
7.70	0.24
6.29	0.11

IBP-D3M2C	
Torque (Nm)	Speed (rev/sec)
6.62	0.61
4.58	0.44
3.62	0.28
1.94	0.12

IBP-D3M3C	
Torque (Nm)	Speed (rev/sec)
13.81	0.80
11.17	0.66
9.46	0.51
7.86	0.37
6.53	0.23
4.82	0.09

IBP-D3M4C	
Torque (Nm)	Speed (rev/sec)
8.50	0.80
7.04	0.66
6.03	0.51
5.01	0.37
4.40	0.23
3.58	0.09

IBP-D3M5C	
Torque (Nm)	Speed (rev/sec)
12.71	0.61
8.80	0.44
5.95	0.27
3.62	0.12

IBP-D3M6C	
Torque (Nm)	Speed (rev/sec)
13.10	0.61
10.31	0.44
7.94	0.27
5.23	0.12

Mortars mixtures

IBP-D1M1M	
Torque (Nm)	Speed (rev/sec)
3.18	0.80
2.84	0.66
2.53	0.51
2.24	0.37
2.03	0.23
1.87	0.10

IBP-D1M2M	
Torque (Nm)	Speed (rev/sec)
3.15	0.80
2.78	0.65
2.46	0.51
2.19	0.36
1.93	0.23
1.69	0.10

IBP-D2M1M	
Torque (Nm)	Speed (rev/sec)
3.24	0.80
2.89	0.66
2.60	0.51
2.33	0.37
2.09	0.23
1.87	0.10

IBP-D2M5M	
Torque (Nm)	Speed (rev/sec)
7.23	0.80
6.35	0.66
5.47	0.51
4.59	0.37
3.72	0.23
2.83	0.10

IBP-D2M6M	
Torque (Nm)	Speed (rev/sec)
3.09	0.80
2.38	0.66
1.74	0.51
1.18	0.36
0.73	0.23
0.38	0.10

IBB Portable Oil tests data

IBP-OIL1	
Torque (Nm)	Speed (rev/sec)
8.68	0.80
7.05	0.66
5.44	0.51
3.82	0.37
2.30	0.23
0.92	0.10

IBP-OIL2	
Torque (Nm)	Speed (rev/sec)
8.68	0.80
7.05	0.66
5.43	0.51
3.81	0.36
2.30	0.23
0.95	0.10

DATA AND GRAPH FROM THE TWO-POINT TEST

MBT ref	UCL test ref	regression analysis output: oil pressure vs speed (voltages)						g (N·m)	h (N·m·s)	Bingham constants	
		idling (mean of two)			concrete (after correction)					yield stress τ_0	plastic viscosity μ
		intercept	slope	R ²	intercept	slope	R ²			(Pa)	(Pa·s)
Concrete											
D1M1Conc	TWOD1M1C	0.057	0.054	0.961	0.239	0.058	0.944	7.00	0.81	855	14
D1M2Conc	TWOD1M2C	0.065	0.052	0.956	0.207	0.061	0.974	5.45	1.50	665	26
D1M3Conc	TWOD1M3C	0.081	0.053	0.955	0.195	0.062	0.966	4.38	1.72	534	30
D1M4Conc	TWOD1M4C	0.074	0.055	0.942	0.188	0.060	0.977	4.37	0.82	533	14
D1M5Conc	TWOD1M5C	0.090	0.049	0.861	0.264	0.050	0.890	6.66	0.09	812	♥
D2M1Conc	TWOD2M1C	0.075	0.056	0.948	0.274	0.054	0.889	7.65	-0.38	933	♥
D2M2Conc	TWOD2M2C	0.099	0.050	0.884	0.142	0.067	0.952	1.63	3.13	198	54
D2M3Conc	TWOD2M3C	0.101	0.052	0.949	0.127	0.103	0.963	1.00	9.46	121	163
D2M4Conc	TWOD2M4C	0.096	0.056	0.885	0.102	0.087	0.990	0.24	5.68	30	98
D2M5Conc	TWOD2M5C	0.067	0.057	0.950	0.119	0.094	0.951	2.01	6.81	245	117
D2M7Conc	TWOD2M7C	0.069	0.057	0.967	0.102	0.091	0.960	1.27	6.19	155	107
D3M1Conc	TWOD3M1C	0.064	0.057	0.943	0.171	0.065	0.977	4.14	1.55	505	27
D3M2Conc	TWOD3M2C	0.065	0.054	0.945	0.080	0.069	0.984	0.58	2.67	71	46
D3M3Conc	TWOD3M3C	0.060	0.056	0.969	0.151	0.073	0.980	3.50	3.15	427	54
D3M4Conc	TWOD3M4C	0.067	0.054	0.964	0.163	0.068	0.907	3.69	2.53	451	44
D3M5Conc	TWOD3M5C	0.059	0.055	0.940	0.087	0.077	0.990	1.07	4.04	130	70
D3M6Conc	TWOD3M6C	0.062	0.056	0.941	0.119	0.079	0.982	2.19	4.37	268	74
Mortar											
D1M1Mort	TWOD1M1M	0.077	0.050	0.932	0.121	0.049	0.987	1.70	-0.21	208	♥
D1M2Mort	TWOD1M2M	0.091	0.046	0.896	0.129	0.051	0.977	1.45	0.87	177	15
D2M1Mort	TWOD2M1M	0.097	0.051	0.900	0.148	0.051	0.975	1.97	0.01	240	♥
D2M5Mort	TWOD2M5M	0.082	0.054	0.912	0.120	0.061	0.977	1.49	1.33	181	23
D2M6Mort	TWOD2M6M	0.063	0.054	0.955	0.061	0.060	0.987	-0.06	1.12	0♣	19
Oil											
	TWOD3M7(oil)	0.079	0.053	0.924	0.061	0.068	0.983	-0.65	2.87	0♣	49
	TWOD3M7(oil)1	0.073	0.055	0.926	0.060	0.069	0.985	-0.48	2.57	0♣	44
	TWOD3M7(oil)2	0.075	0.058	0.913	0.065	0.070	0.981	-0.38	2.25	0♣	39

♥ the recorded plastic viscosity values were low or negative for these mixes. The yield stress values were high (and slumps relatively low) and we believe that during testing the air pockets created immediately behind the impeller blades may not have refilled with concrete or mortar before the next pass of the blade, resulting in falsely low values of torque at increasing impeller speed, and hence invalid plastic viscosity. There is sufficient confidence in the yield stress values for their use in the subsequent analysis.

♣ negative recorded values for yield stress, which can be considered as zero.

Concrete Mixtures

Mix D1M1Conc

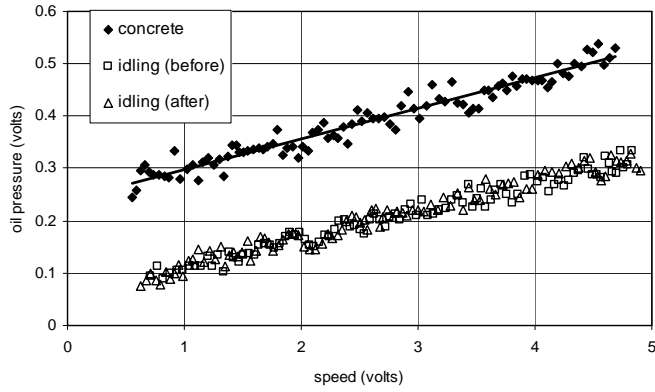

Mix D1M2Conc

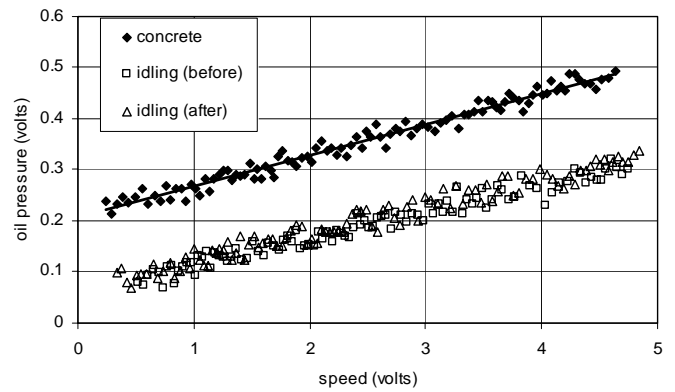

Mix D1M3Conc

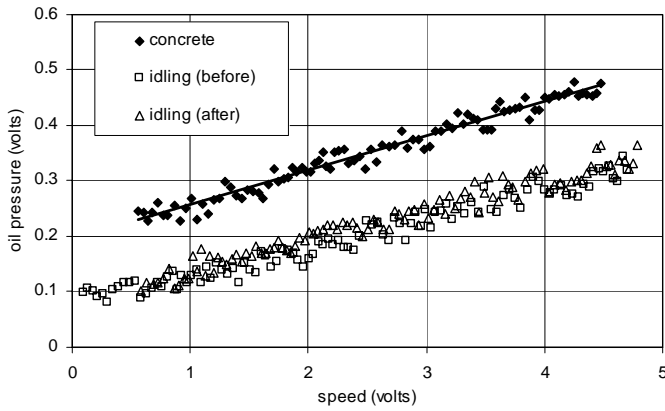

Mix D1M4Conc

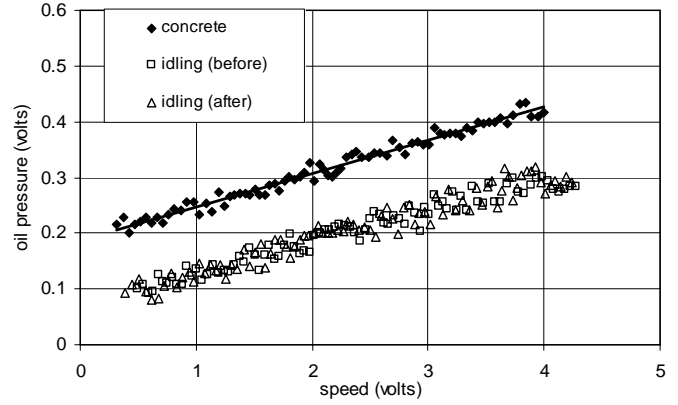

Mix D1M5Conc

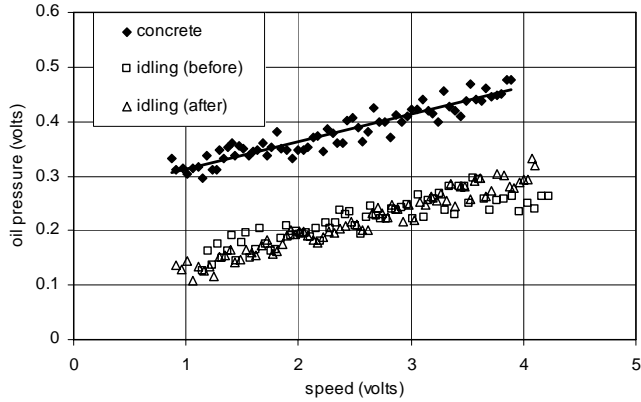

Mix D2M1Conc

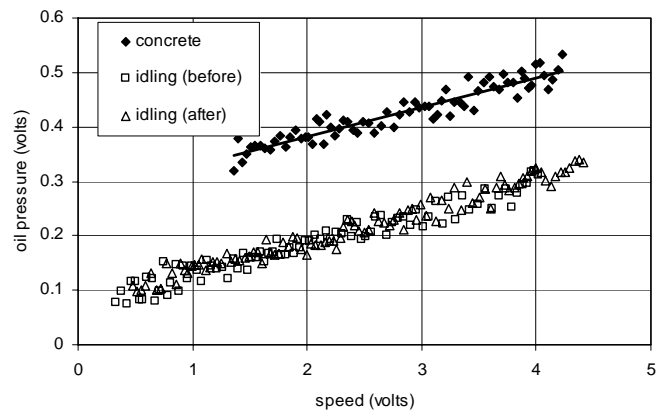

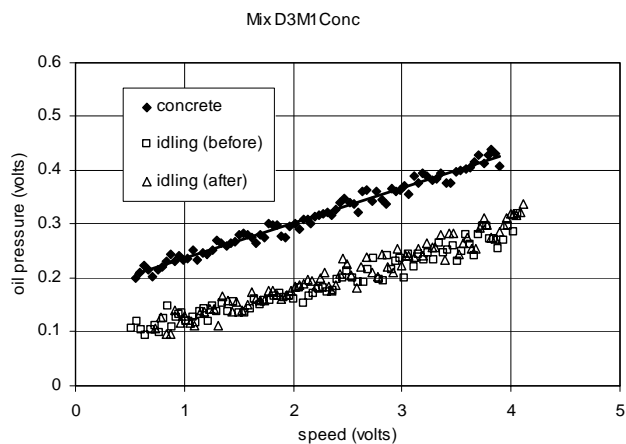
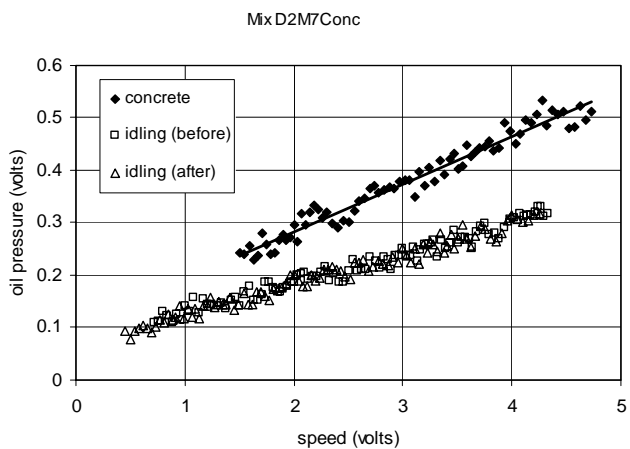
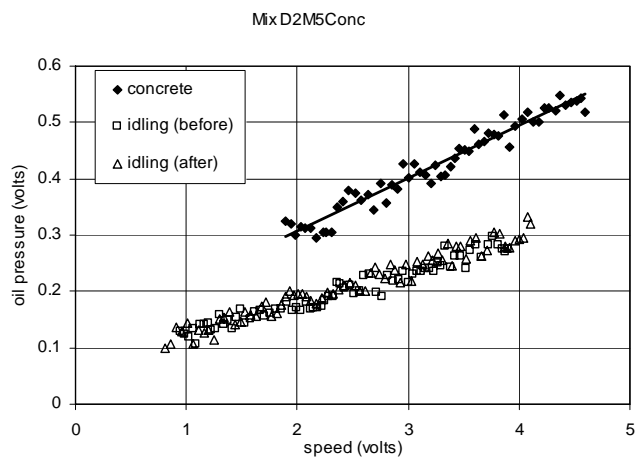
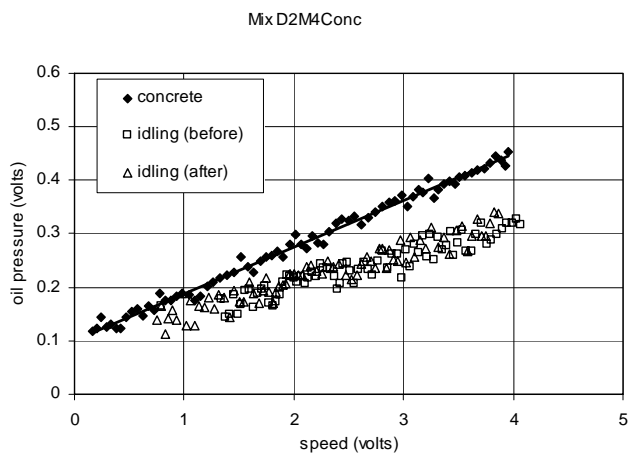
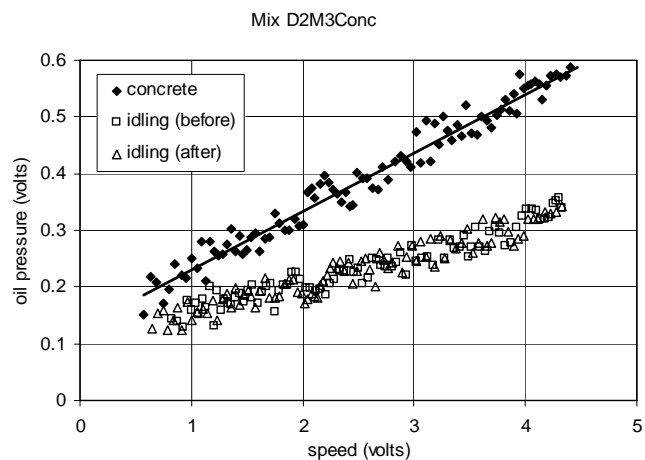
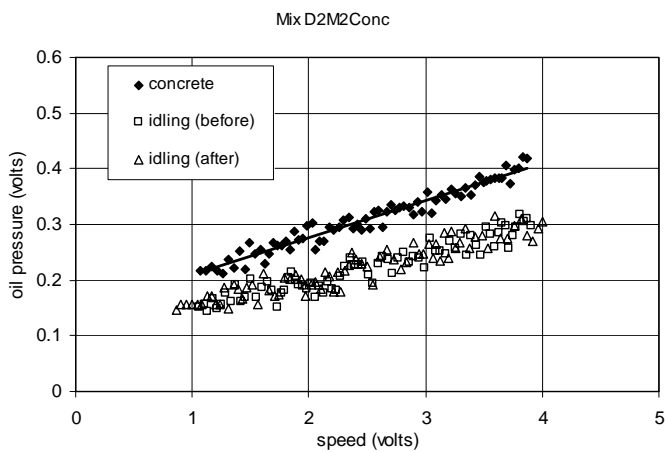

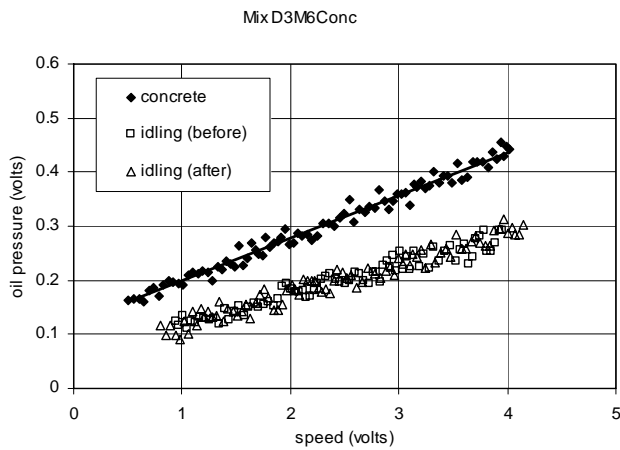
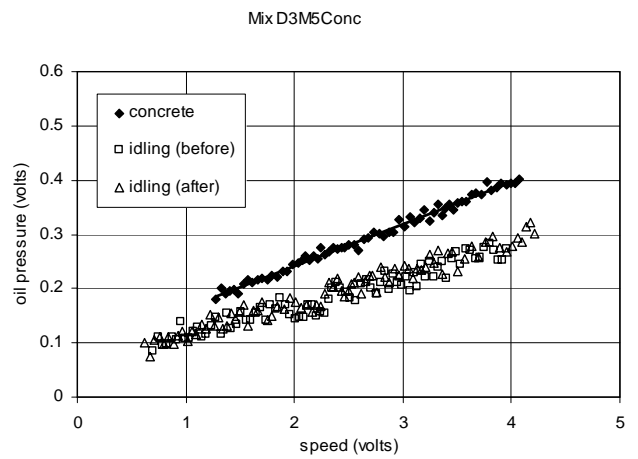
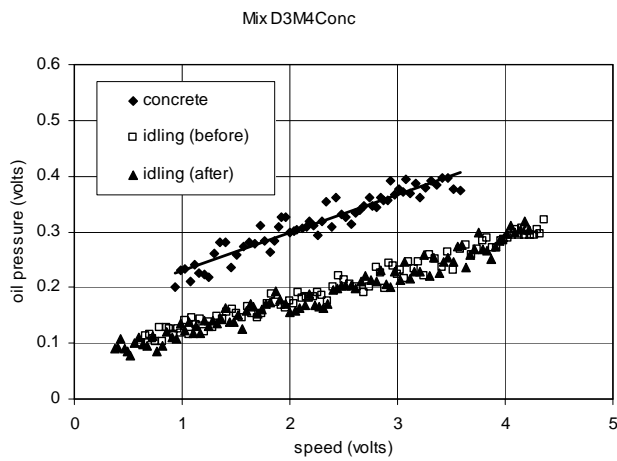
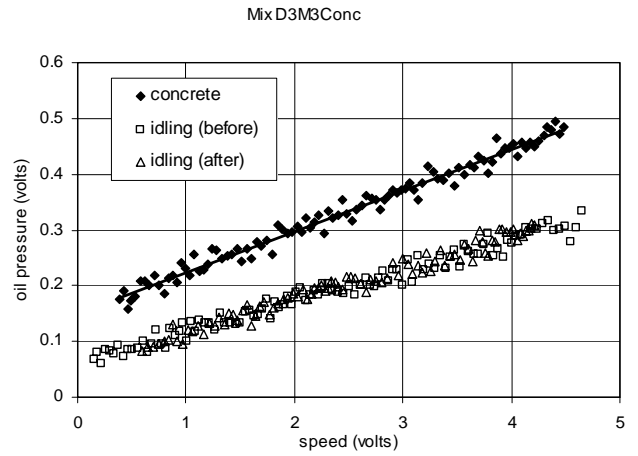
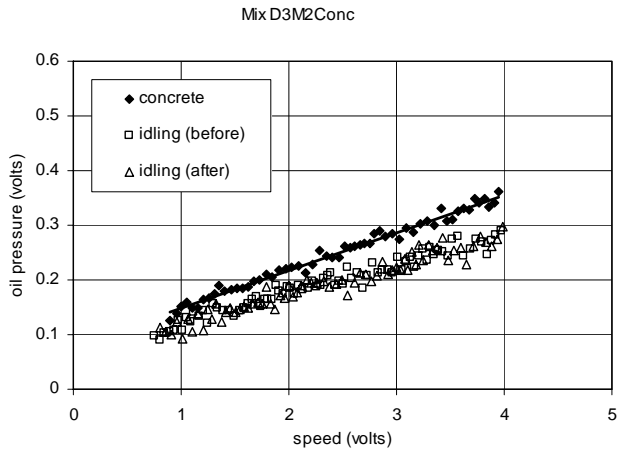

Mortar Mixtures

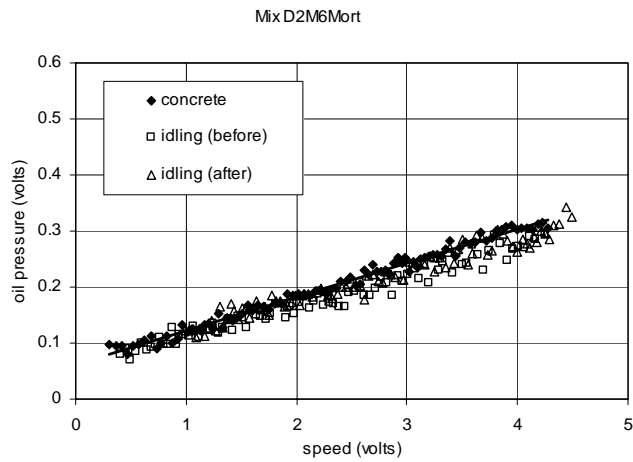
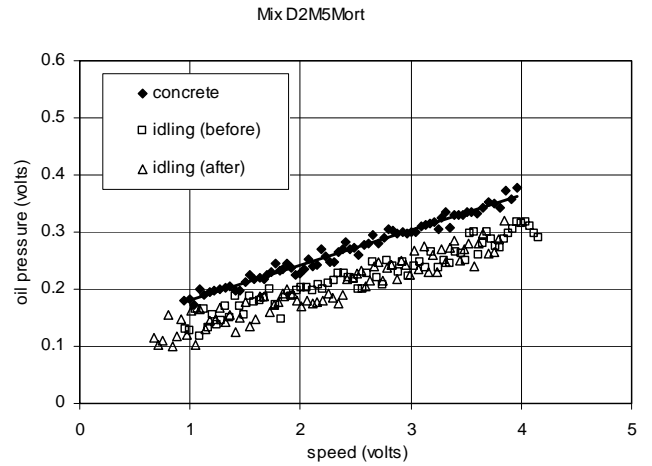
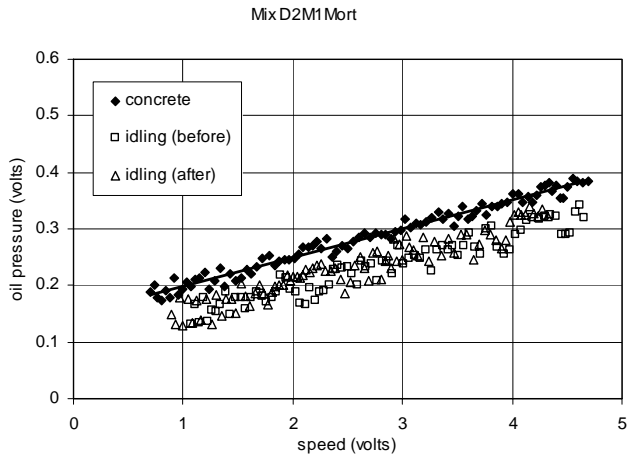
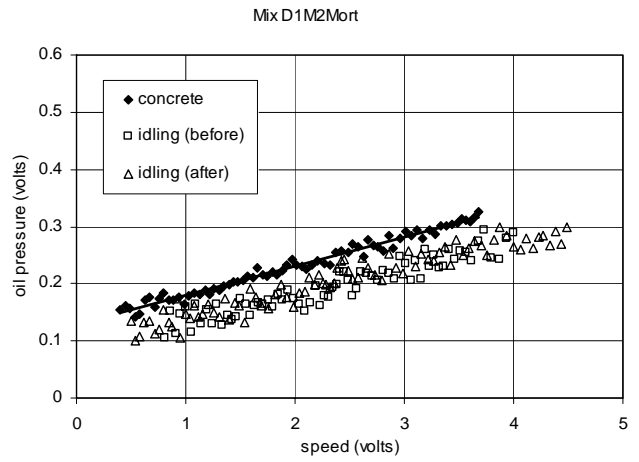
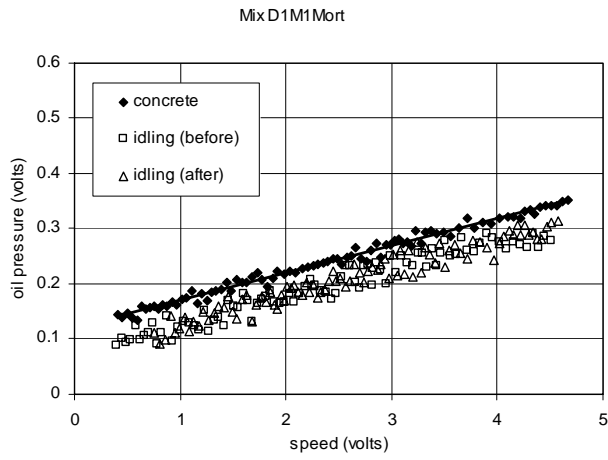

Oil

D3M7(oil)

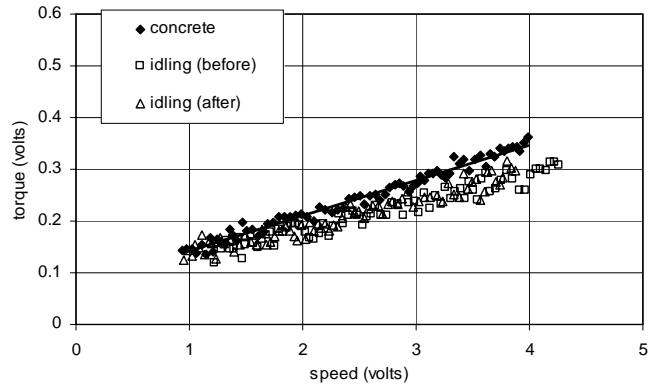

D3M7(oil)1

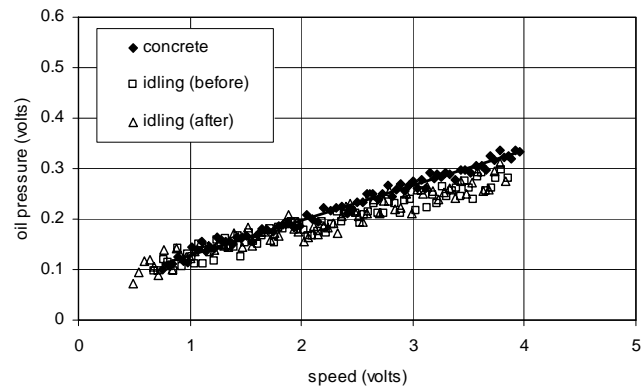

D3M7(oil)2

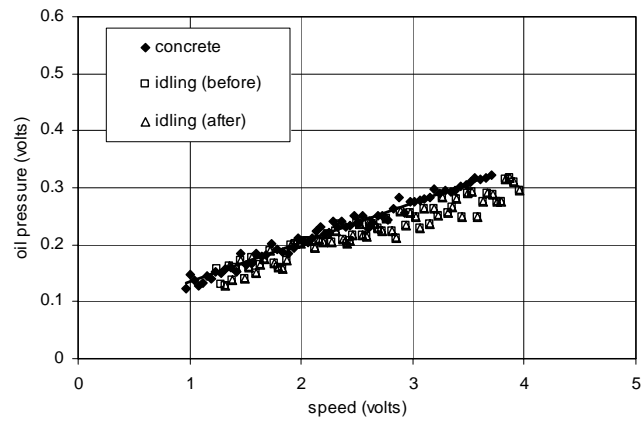

DATA AND GRAPH FROM THE UIUC RHEOMETER

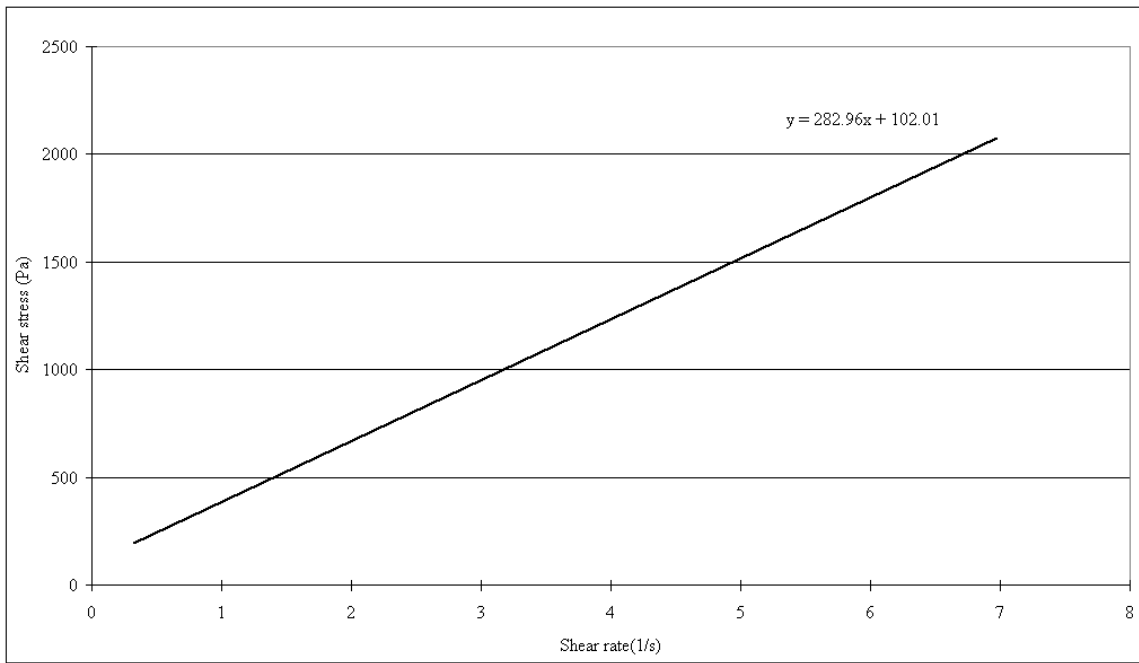

Torque-rotational speed curve of silicone oil. Test 1

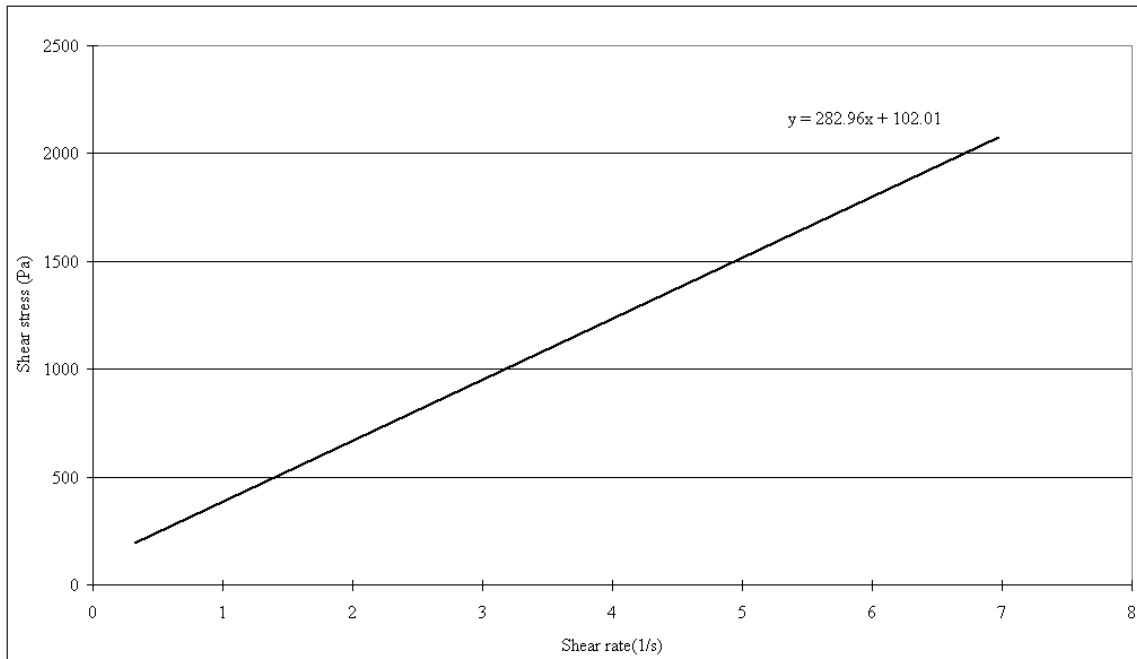

Shear stress-shear rate curve of silicone oil Test 1

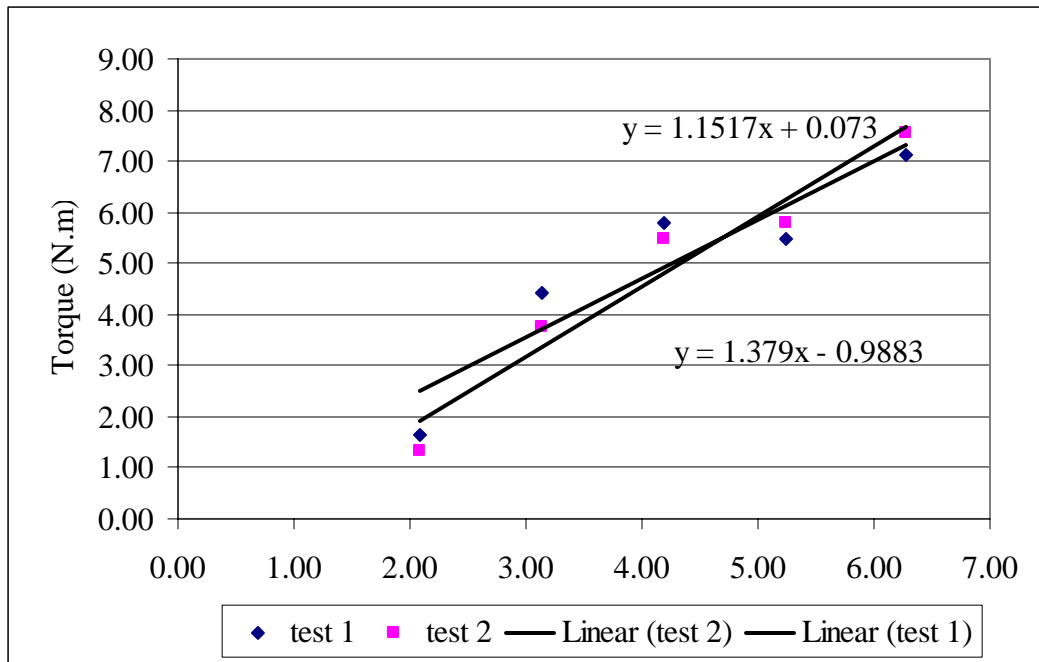

Torque-rotational speed curve of re-tested silicone oil :Test 1 and 2 repeat

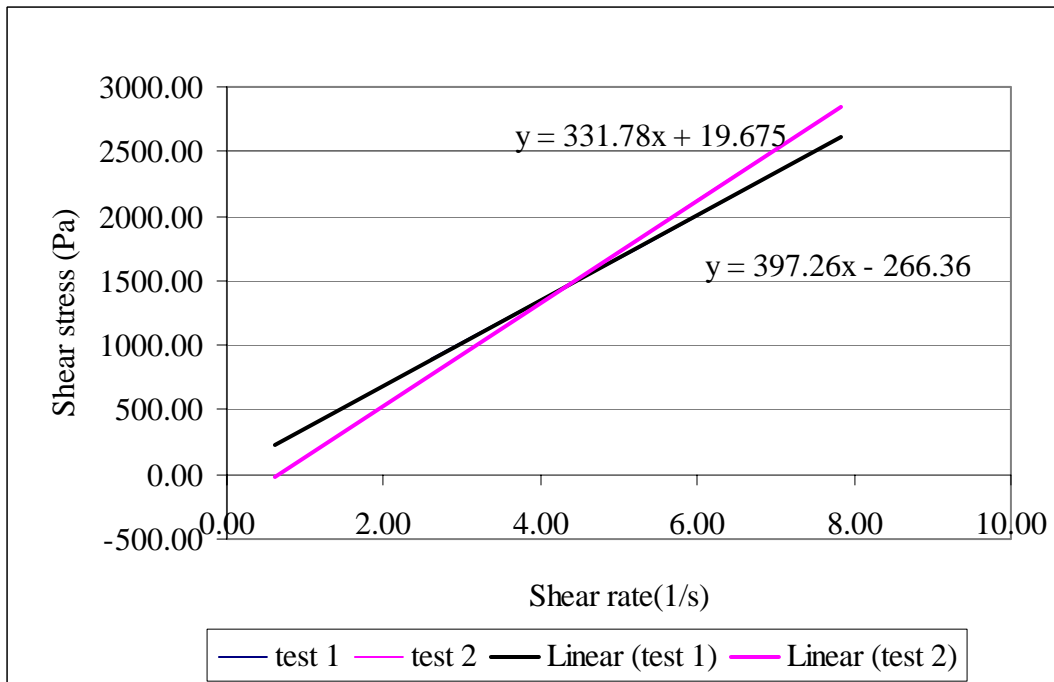

Shear stress-shear rate curve of retested silicone oil: Test 1 and 2 repeat

Table 1 Torque data of silicone oil, Test 1

Rotational Speed (rpm)	20	30	40	50	60		
Rotational Speed (rad/s)	2.09	3.14	4.19	5.24	6.28		
Shear Rate (1/s)	2.61	3.92	5.23	6.53	7.84		
Torque N·m	1.69	2.45	3.13	3.75	4.573	$T=$	$dT/d\Omega=$
Shear stress (Pa)	759.89	1088.83	1417.77	1746.71	2075.65	0.2922	0.6748

Table 2 Torque data of retested silicone oil: Test 1 and test 2 repeat

Rotational Speed (rpm)	20	30	40	50	60		
Rotational Speed (rad/s)	2.09	3.14	4.19	5.24	6.28		
Shear Rate (1/s)	2.61	3.92	5.23	6.53	7.84		
Test 1 torque lb.in	14.33	38.36	50.42	47.72	62.08		
Test 1 torque N·m	1.65	4.41	5.80	5.49	7.14	$T=$	$dT/d\Omega=$
Test 1 Shear stress (Pa)	886.48	1319.89	1753.29	2186.69	2620.10	0.073	1.1517
Test 2 torque lb.in	11.60	32.83	47.72	50.42	65.59		
Test 2 torque N·m	1.33	3.78	5.49	5.80	7.54	$T=$	$dT/d\Omega=$
Test 2 Shear stress (Pa)	771.52	1290.46	1809.40	2328.34	2847.28	-0.9883	1.379