

Volume 2

Volume 2

Detailed Contents.

SITES AND EVIDENCE.		Eutresis Urfirnis	58; 174
Corinth	24	Chronology	178
Akrata	29	Summary	181
Gonia	30	MN - LN transition	39; 192
Nemea	31	PERIOD III	184
Klenia	32	Sites	186
Prosymna	33	Urfirnis	188
Franchthi	35	Hybrid	189
Lerna	40	Black on Red	191
Kefalari	46	" " discuss	194
Ayioryitika	46	" " chronology	197
Asea	47	Black Ware	199
Koufovouno	48	" " chronology	214
Alepotrypa	49	" " northern parallels	215
Elateia	53	Red Slip	219
" EN	54	Grey Ware	220
" MN	55	" " chronology 27-29;	239
" Bothros	57	Grey on Grey	243
" Urfirnis	58; 174	Rhyta	245
" Bl on Rd	59	Matt Painted Ware	249
" Grey/Black	60	" " north. parallels	270
" Rhyta	61	" " origins	272
" Chronology	62	Polychrome Ware	275
PERIOD I		" decoration	280
Phases	67	" three styles	283
EN origins	23; 36	" north. parallels	285
Sites	70	" chronology	289
Ware and finish	72	Red Burnished and Painted	290
Shapes	80	Coarse Ware	292
Decoration	100	Dot Incised Ware	293
Colours, Table I	101	PERIOD IV	296
Summary	115	Sites	297
PERIOD II	118	Prosymna Incised Ware	300
Phases	120	Stroke & Pattern Burn.	304
Sites	121	Crusted Ware	310
Technique - burnish	129	Painted Ware	318
Shapes	132	Early Monochrome	321
Figurines	149	Early/Late Monochrome	325
Legs	152	Late Monochrome	335
Painted Decoration	158	Baking Pans	329
Potters' Marks	170	Plastic decoration	331
Northern distrib.	172	Rolled Rim Bowls	337.



Chronological Charts

They are explained and discussed on p. 350. The abbreviations on the charts are as follows:

Chart I

FM = Fine Monochrome, of the thin-walled black or buff variety
(2,4. 10 etc).

EP = Early Painted

LP = Late Painted

SS = Smeary slip, and, generally, the different kinds of proto-firnis.

WW = White Ware

PC = Proto Carinations, angular shoulders.

CJ = Collar Jars

Urf = Urfirnis: Urfirnis proper, not the intermediate low-lustre slips.

S-F = Stroke-Firnis

B1 = Black Monochrome of the Period III kind

MP = Matt Painted ware

Chart II

MPa = Normal matt dark paint on buff or cream

MPb = Red, or glossy dark paint

Gr = Fine Grey ware

LP = Late Polychrome of the Klenia-Prosymna varieties

Chart III

Pros.Inc. = Prosymna Incised ware

Cr = Crusted ware

SB = Stroke Burnished

PB = Red Pattern Burnished ware of the Prosymna and Aigina kinds

Ago-Kef = Types and traits of the Agora-Kefala culture

Pelos-Alep = All the types and traits associated with the rolled-rim bowls from sites on the islands, in Attica and the Peloponnese.

The carbon-14 series on Chart III are based on the following published dates (B.C.) :-

1. Franchthi (Jacobsen 1973a, table 8; Radiocarbon 13, 1971, 364f; 14, 1974, 214)

P 1660	3311 +/- 64	FN
P 1659	3213 +/- 78	FN

2. Halieis (Radiocarbon 13, 1971, 367)

P 1397	3152 +/- 72	Bedrock deposit of shell with Kefala.
--------	-------------	---------------------------------------

3. Kefala (Caskey 1968, 314; Radiocarbon 11, 1969, 156)

P 1280	2876 +/- 56	Kefala Culture.
?	3031 +/- 58	" "

4. & 6. Sitagroi (Renfrew 1970, 302)

Bln 773	2440 +/- 100	Sitagroi IV, E.B. I.
Bln 782	2360 +/- 100	" "
Bln 78I	2135 +/- 150	Sitagroi V, E.B. II.
Bln 780	1920 +/- 100	" "

5. & 8. Eutresis (Kohler and Ralph 1961, 357f)

P 306	2496 +/- 66	Group IV, EH I.
P 307	2492 +/- 57	Group III, EH I.
P P 317	2262 +/- 56	Group VIII, EH II.

7. Lerna (Kohler and Ralph 1961, 365)

P 318	2120 +/- 65	House of Tiles, EH II.
P 319	2027 +/- 59	" "

The lateness of the Lerna dates could be due to a number of methodological factors, but it is also worth remarking that the earliest EH II material from the site belongs to a typologically developed stage and therefore does not represent the beginning of EH II.

The carbon-14 series on Chart IV are based on the following published dates (B.C.); those marked with an asterisk were not used on the chart because the degree of discrepancy makes their reliability doubtful :-

Franchthi (Jacobsen 1969, 374-5; 1973a, table 8; Radiocarbon 13, 364f; 14, 214 f)

P 1526	6072 +/- 76	Mese - Neo transition.
P 1527	5947 +/- 88	" "

P 1392	5844 +/- 140	Aceramic
P 1525	5754 +/- 81	EN
P 1667	5328 +/- 86	EN
P 1399	5244 +/- 112	Start of Urfirnis: MN
*P 1824	4718 +/- 74	EN - MN transition.
P 1922	4835 +/- 87	MN
P 1922A	4780 +/- 73	MN
P 1537	4696 +/- 79	MN
*T 6128	4905 +/- 150	MN - LN transition
P 1662	4741 +/- 81	Early LN
P 1661	4206 +/- 70	LN
P 1630	4160 +/- 86	LN
*P 1921	6457 +/- 92	LN
P 1920	4222 +/- 60	LN
P 1660	3311 +/- 64	FN
P 1659	3213 +/- 78	FN
<u>Halieis</u> (Radiocarbon 13, 1971, 367)		
P 1399	3152 +/- 72	FN (Kefala culture)
<u>Kefala</u> (Caskey 1968, 314; Radiocarbon 11, 1969, 156)		
P 1280	2876 +/- 56	FN
?	3021 +/- 58	FN
<u>Elateia</u> (Radiocarbon 5, 1963, 182-3)		
Grn 2973	5530 +/- 70	EN Monochrome.
Grn 3037 +/-	5410 +/- 90	"
Grn Grn 3041	5240 +/- 100	"
*Grn 3039	6290 +/- 110	Early Painted, EN.
Grn 3502	5090 +/- 130	"
Grn 2454	4420 +/- 80	"
<u>Asfaka</u> (Higgs and Vita-Finzi 1966, 22)		
I 1959	5430 +/- 240	Possibly EN.
<u>Sidari</u> (Sordinas 1967, 64)		
GXO 771	5720 +/- 120	Earliest pottery; plain monochrome.

GXO 772	5390 +/- 180	Impressed EN
<u>Sesklo</u> (Radiocarbon 15, 1973, 369)		
P 1682	5533 +/- 72	Aceramic
P 1681	5805 +/- 97	"
P 1680	5350 +/- 93	"
P 1679	5661 +/- 83	Earliest pottery, EN
P 1678	5477 +/- 78	"
P 1677	4791 +/- 103	End MN II
P 1676	4367 +/- 85	End MN III
P 1675	4744 +/- 87	MN III
*P 1674	5014 +/- 92	MN III
P 1672	4554 +/- 85	MN III
P 1671	3672 +/- 80	LN reoccupation (Dimini III/IV).
<u>Argissa</u> (Theocharis 1973, 119)		
Grn 3502	5550 +/- 90	EN
*Grn 2454	4420 +/- 80	EN
<u>Nea Nikomedeia</u> (Radiocarbon 4, 1962, 69; 9, 1967, 335)		
*Q 655	6240 +/- 150	EN
P 1202	5607 +/- 91	EN
P 1203A	5331 +/- 74	EN
<u>Servia</u> (personal communication by Mrs Ridley)		
BM 1103	4930 +/- 49	Middle MN
BM 1104	4797 +/- 51	"
BM 1105	4756 +/- 53	MN destruction
BM 1106	4740 +/- 83	Earlier MN
BM 1107	4656 +/- 55	LN destruction (Early LN)
<u>Kitsos</u> (Radiocarbon 16, 1974, 54f)		
Gif 1280	3520 +/- 150	Layer 3a.
Gif 1610	3400 +/- 200	Layer 3.
Gif 1832	3700 +/- 130	Layer 4
Gif 1670	3600 +/- 150	Layer 4.
Gif 1729	3800 +/- 130	Layer 4

Gif 1612 3750 +/- 140 Layer 4.

Saliagos (Evans and Renfrew 1968; Radiocarbon 13, 1969, 157)

P 1393	3766 +/- 85	LN
P 1333	3825 +/- 84	LN
P 1368	3959 +/- 87	LN
P 1396	4124 +/- 79	LN
P 1311	4222 +/- 74	LN

The list is not exhaustive. Other dates, which were not known to me at the time Chart IV was drawn, include two from Argissa, of which the first is clearly erroneous and the second is in general agreement with those from Sesklo and Kitsos: -

Argissa (Milojčić 1961, 446)

H ?	4870 +/- 120	Aceramic EN
H ?	3680 +/- 150	LN. Dimini III/IV

Recently published dates from Achilleion add welcome confirmation to the EN and MN series in Thessaly (Radiocarbon 17,2, 1975, 200-201). New dates for the Franchthi Early Neolithic confirm the earliness of the first neolithic in the Peloponnese and suggest that perhaps Q 655 from Nea Nikomedeia is not as improbable as has been thought. One of them (P 2093) appears to be rather late, but its cultural context is not given in detail and it may be in order.

Franchthi (Radiocarbon 17,2, 1975, 201-3)

P 2093	4990 +/- 90	Late EN
P 2094	5980 +/- 100	EN
P 2095 +/-	6030 +/- 110	EN.

+++++ Aceramic

EN - - - - MN I-I-I-I-ILN

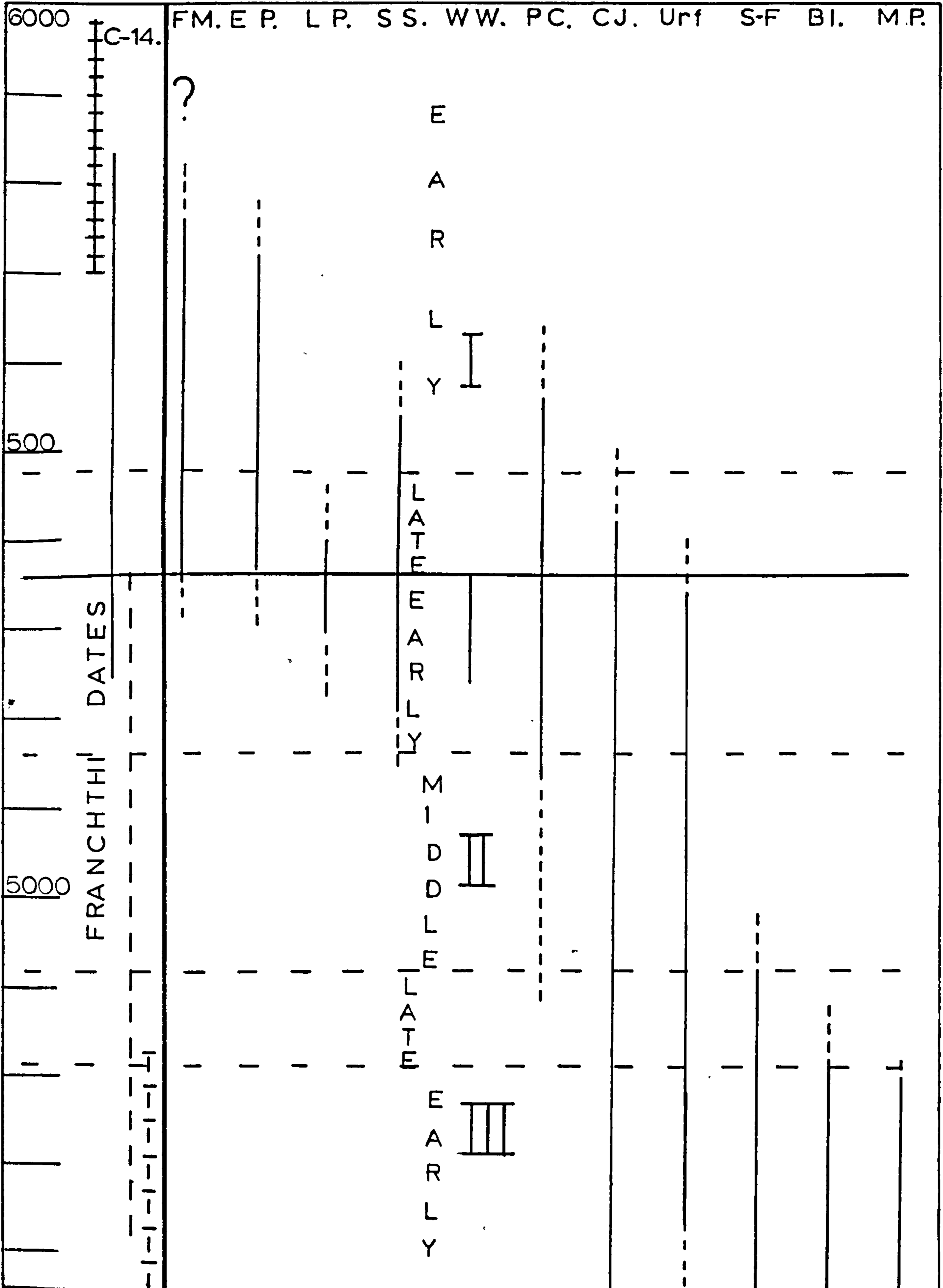

CHART I

---MN

---ILN

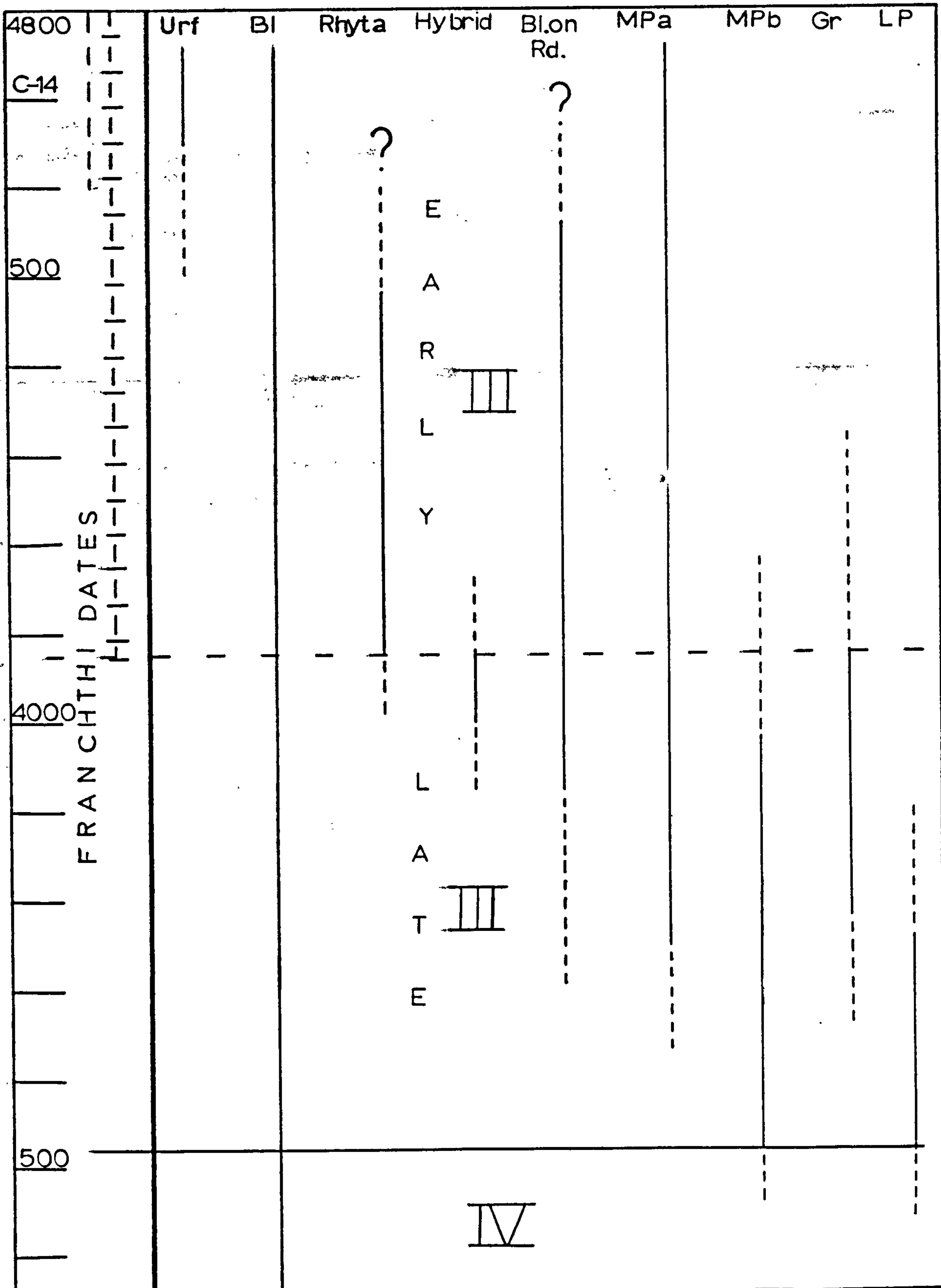

CHART II

.....Early Period IV EHI = = = EHI

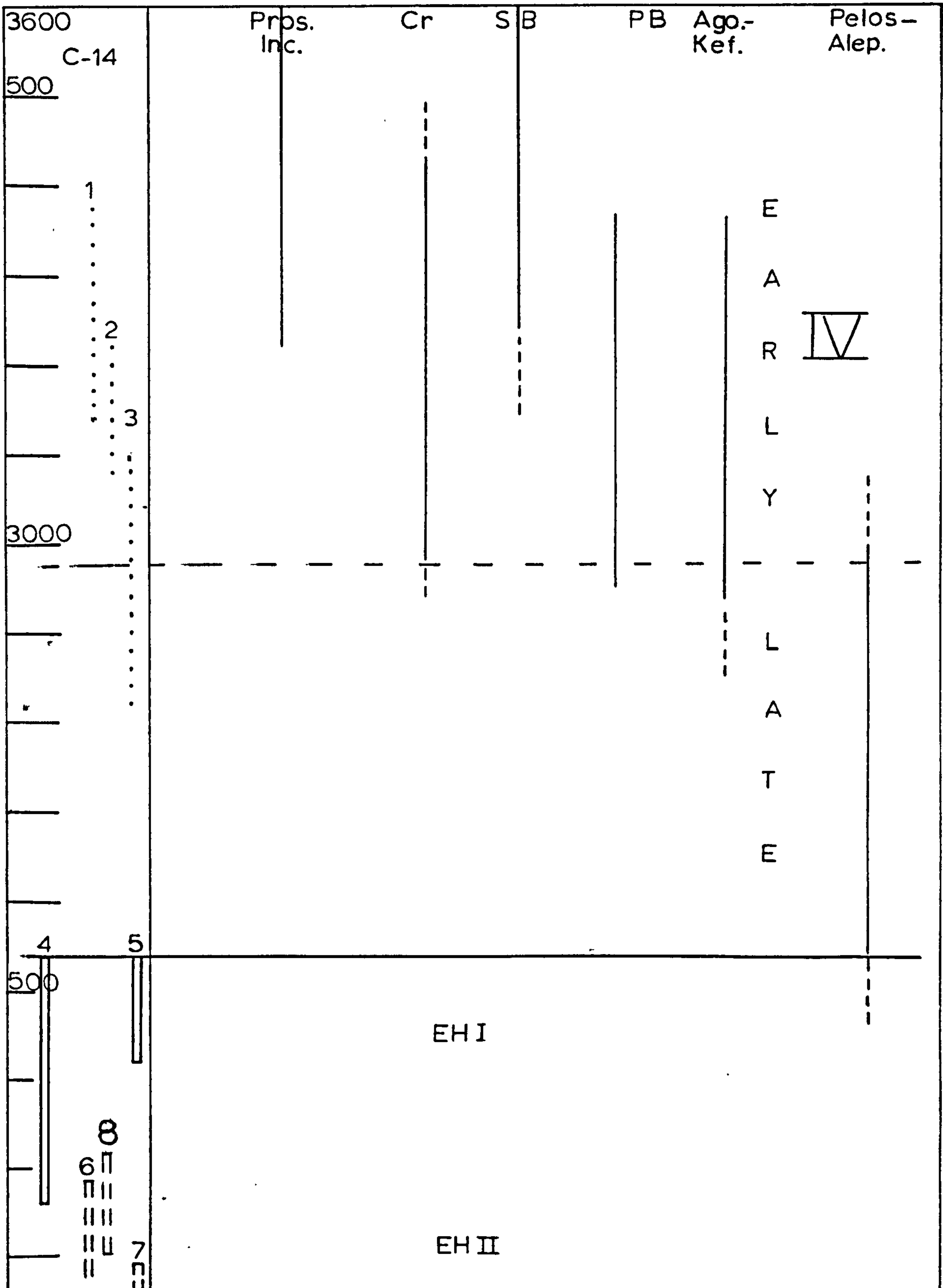

CHART III

++++ Aceramic
 ——— EN
 - - - - MN
 - - - - LN
 FN

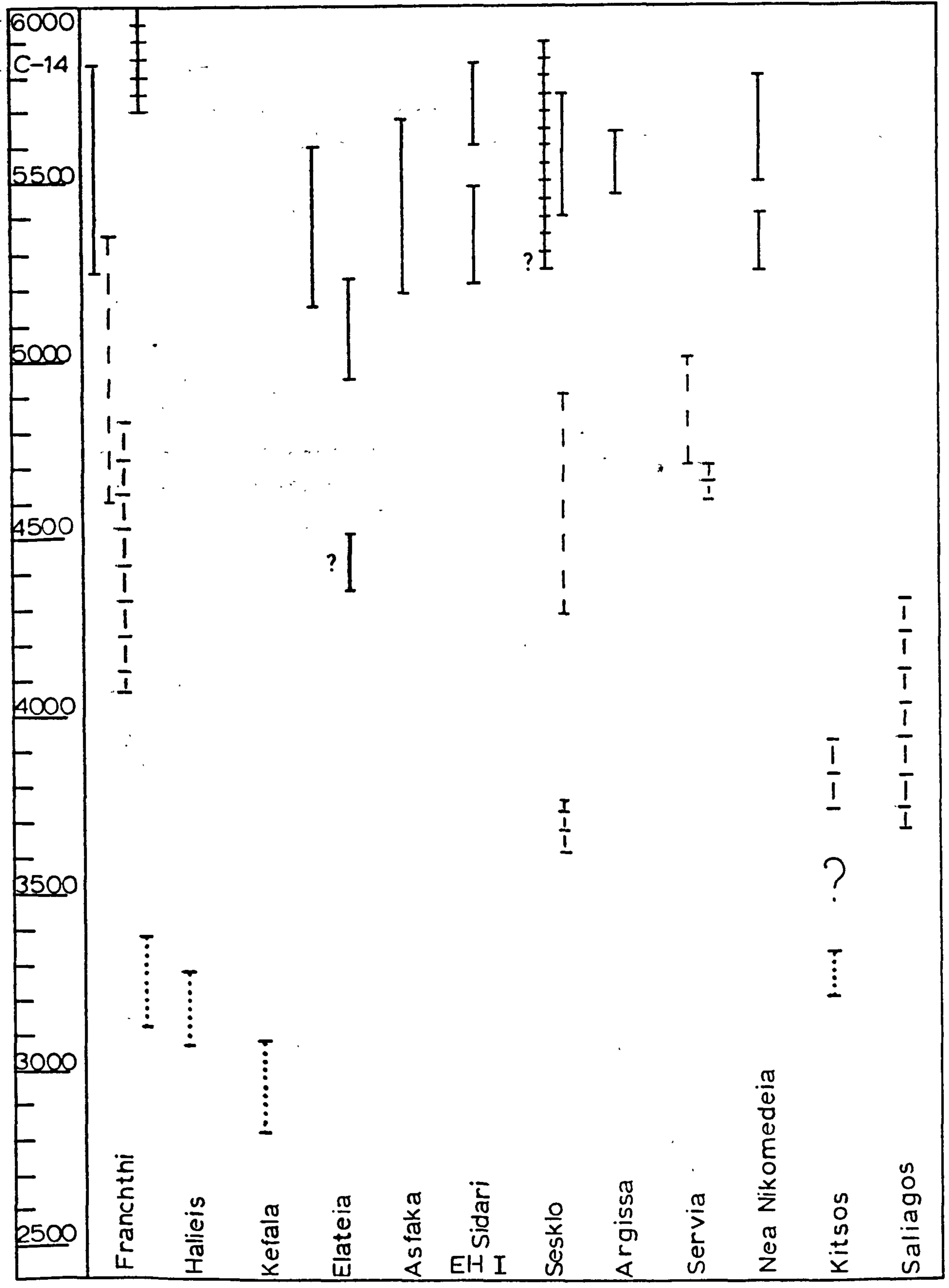

CHART IV

Catalogue of Illustrations

Most of the abbreviations used in the descriptions of the drawings and photographs will be obvious, but a short key is given below to avoid possible ambiguities. Where known, the deposit, stratum and inventory numbers follow the name of the site. Figures in brackets refer to other illustrations of the same sherd or vessel, and the description is only given once. "LWK" refers to an assortment of old Walker-Kosmopoulos material without labels which Dr. Williams kindly allowed me to rummage through, and which produced some fine specimens of certain wares and types. "1937" refers to the material from Weinberg's excavations on Temple Hill, and "1959" to the large collection from his excavations of that year in the Forum West and Lechaion Road areas, of which I only examined a small fraction. "KDV" after a Lerna profile means that it was taken from a drawing by Dr. Vitelli, to whom thanks are warmly tendered. I am deeply indebted to Professor Caskey for allowing me to study and draw representative material from his excavations, and to Professor Weinberg for allowing me to use the results of his Corinth excavations. Dr. Croissant most amiably put the neolithic material from the French School excavations at Argos at my disposal.

A discussion of the illustrated pieces, and sometimes a more detailed description, will be found in the appropriate section of the Catalogue of Shapes which deals with the particular ware, shape, feature or decoration.

b	- burnish(ed)	brshd	- brushed
bdy	- body	ch	- chocolate
bf	- buff	crm	- cream
bge	- beige	crse	- coarse
bl	- black	dk	- dark
brk	- brick red	fn	- fine
brn	- brown	fnt	- faint

glsy	- glossy	pb	- pattern burnished
gr	- grey	rd	- red
grn	- green	rm	- rim
grts	- grits	scrib	- scribble
grtless	- gritless	sft	- soft
grve	- groove	slp	- slip
hd	- hard	slur	- slurry
inc	- incised	smry	- smeary
l	- low	smth	- smooth
lstr	- lustre	spgy	- spongy
lt	- light, pale	st	- stratum
mahog	- mahogany	strky	- streaky
med	- medium	thk	- thick
mott	- mottled	thn	- thin
mt	- matt	v	- very
nr	θ near(ly)	w	- with
or	- orange	yel	- yellow

I am exceedingly obliged to the Corinth Excavations, who kindly provided the following photographs :

74, 25

80, 1

84, 12

86, 1 - 6

87, 1

92, 3 - 5

94, 1

Fig. 1

Period I.

1. Lerna; bf, fn wh grts; rd-brn smeary l lstr slip out;
rd same in.
2. Nemea; sft brk-bf; thin sh slip out; or slip in; smthed.
3. " spgy; rd-brn smth slp out; or-rd same in.
4. " Zervos 319; fn bl; l b dk gry slp out; smth same in.
5. Lerna; pit BE, 2cd St; fn bl b ?slp out/in.
6. Nemea; v hd bf; rd slp w dk streaks out/in.
7. " hd brk, fn wh grts, thn gr core; thk rd slp w bl
streaks out/in.
8. Lerna; pit BE, 2cd St; hd grty gr; bge-bf b out/in, strong
b marks out.
9. Franchthi; 123; glsy bl b out; smth w bl b strokes in.
10. Lerna; 1142, G 1st St; spgy; l b rd dk bf mottl slp out/in.
(KDV)
11. Nemea; smth or-rd slip out/in.
12. Corinth; LWK; fn hd dk gr; l b rd-bf out; dk gr to bl v
smth in.
13. " LWK; fn bl; dk gr to bl smth out/in; fn b strokes
in.
14. Lerna; 1147, J; bf, wh grts; l lstr bl strky rd slp out/in.
(KDV)
15. Nemea; fn gr-bf; dk rd b out; smth in (worn).
16. " fn lt bf; worn pnt out; smth in.
17. Corinth; LWK; l b rd-bf in; l b bf .050m band, bl below, out.
18. " : 1937; spgy, wh grts; smth lt gr-bf in; bl below,
out.

Fig. 2

Period I.

1. Tarsina; hd lt bf fn grtless; lt bf b out/in; dull rd-brn
pnt in.

2. Asea; hd dk bf, fn wh grts; glsy b rd on dusky bf out, smth
bf in.
3. Nemea; hd bf; l b bf out; bright rd slp in.
4. Ayioryitika; bf; bf above, bl below, sharp line, out/in
(67,15).
5. Nemea; sft lt or-rd; or-rd pnt on bf out. (v atypical of
site; 66,2).
6. " sft lt or-bf; rd on bf b out/in (66,23).
7. " fn bl b out/in.
8. Lerna; J Pebble Layer; fn gr; glsy b tan-bge slp out/smth
in; bl below.
9. Nemea; sft bf; rd on smth bf out; rd slp in.
10. " fn bl; surfaces worn, probably bl b slp once.
11. Ayioryitika; fn hd or-rd, fn wh grts; l b rd-brn slp out/in.
13. Lerna; pit BE, 2 cd St; fn grtless lt bf; thn brshd rosy
slp out/in.
14. Ayioryitika; fn bf; had rd pnt zigzag out, worn (76, 10).
15. Asea; Holmberg 1944, pl. IIIa; rd pnt, thk l lstr slp over;
pnt blobs in (68, 2).
16. Asea; Holmberg 1944, fig. 38b; gr, wh grts; smth-scraped
bl/rd mott (68,1).

Fig. 3

Period I.

1. Nemea; fn sft bf; b rd-brn pnt & slp on bf out; smth bf in.
2. " fn bl; bl b our/in; shallow grooves.
3. " as 2; low rib formed by two grooves; shallow rim groove
4. " as 2; v shal grves; b marks in.
5. Lerna; J, St on virgin soil; fn hd bl; glsy bl b slp out;
l b in; grves.
6. Nemea; as 2.
7. " sft pink; b or-rd pnt & slp on b pink-bf; b bf in.
8. " yel-bf; l b or-rd pnt out; smth in.
9. Ayioryitika; lt pink-bf; rd pnt & slp, rd overslp, streaky,
out; slp in.

10. Nemea; fn hd dk gr; bl b out/in.
11. Lerna; J, Pebble Layer; lt brk; rd mt pnt & slp on b bf out;
rd mt slp in.
12. " pit AP, 1st St; hd lt brk; l lstr pink-bf slp, dk
at rm, out/in.
13. Nemea; Zervos 118; dk gr; bl b out/in.
14. Lerna; pit AP, 2 cd St; spongy; b brn to dusky out; near
bl in.
15. Nemea; gr fn; glsy b tan and dk; low rib between two grooves.
16. " Zervos 122; bf, wh grts; b rd-brn to or-brn slp out/in.
17. " sft fn bf; thin b rd-brn slp, fnt tool marks.

Fig. 4

Period I.

1. Corinth; LWK; smth bf out/in, bl bottom.
2. Nemea; fn bf; med grts, bl & quartz; b or-rd on thn wh slp
out; b in.
3. " hd fn pink bf; rd on b bf out; mt rd slp in (66, 29).
4. Lerna; pit BE, 2cd St; hd brk, wh grts; mt rd pnt on mt
or-bf slp; b slp in.
5. Asea; hd dk porous; med and fn wh grts; crusty wh on rd-brn
b slp.
6. Corinth; Babbus Mon; hd bf; rd slp, bl on lip.
7. Nemea; fn hd spongy; smth mt dk rd slur out; bl same in.
8. Corinth; LWK; fn sft lt rd; lt rd-bf b out; smth in.
9. Lerna; J, St on virgin soil; rd w dk core; l b dk rd to
bl at rm; bl in.
10. Nemea; sft lt rd-bf; rd pnt out; red slp in.
11. Franchthi; FP 48; Jacobsen 1969, pl.94c; thn slp, mott, out.
12. Corinth; 1937; fine bl b out/in.
13. Asea; med fn rd; wh grts; wh pnt on smth rd out; smth dusky
rd in.
14. Nemea; v hd fn bf; b rd on b bf out; smth rd slp in.

15. Lerna; J, St on virgin soil; lt or-rd, fn spongy; or-bf
b out; smth in.
16. Ayioryitika; lt rd; full wh grts; smth bl & tan mott out;
smth dk in.
17. Nemea; dk gr & bf; rd-brn b slp out; dark in.
18. Asea; Holmberg 1944, fig.46a; porous bl & dk rd core;
crusty wh on dk b.
19. Ayioryitika; hd lt rd; full wh grts, spongy; rd slur out;
dk smth in (67, 17).
20. Franchthi; H-37-U; dk hd; b bl slp out, vert b marks;
horiz paring in.
21. " H-37-Π; fn glsy bl b.
22. Nemea; fn sft bf; glsy b or-rd on bf out; b ? thn wh
slp in (66, 24).

Fig.5

Period I.

1. Nemea; sft bf; rd pnt.
2. " rd on fn bf.
3. Franchthi; F/F1, 42b; v fn bl b out/in.
4. Nemea; bright glsy b rd pnt on smth bf-bge (66,13).
5. " bf; rd slp, worn.
6. " fn bf, small lt & dk grts; rd pnt on rm out/in.
7. Franchthi; H-37-P; thn dk brn mt pnt on smth dusky slurry.
8. Nemea; fn bf out, gr in; or-rd on b bf out; smthd gr in.
9. Franchthi; FP 164; hd dk rd; dk rd on b bge-bf. Jacobsen
1973b, fig.3,4; pl 49b.
10. " FP 163; hd bge-bf, wh grts; glsy b, shows marks,
out; pared in.
11. Nemea; hd med fn bf; smthd out, traces thn rd slp; smthd in.

Fig.6

Period I. |

1. Nemea; fn hd bf out, gr in; fn wh & dk grts; rd on tan-bf
out; gr in.

2. Nemea; b or-rd on bf out.
3. " fn sft lt bf; rd-brn slp out; same in rim.
4. " lt rd; or-rd on bf out; rd in rim.
5. " gr spongy, shell grt; brn-rd on lt bf out, in rim.
6. " hd bf, med wh & dk grts; or on l b bf out, in rm (66,1).
7. " fn hd spgy bf; deep flakey rd pnt.
8. " sft or-bf; md wh & dk grts; b rd slp out.
10. " lt rd-bf, full angular wh grts; spongy; l b dk rd on l b bf out.

Fig.7

Period I.

1. Nemea; sft bf, fn wh & gold mica grts; bl, rd-brn in parts, l lstr pnt (66,14).
2. Ayioryitika; fn hd or, few fn wh grts; b even rd-brn slp, no marks.
3. Lerna; J; fn bf; mt rd pnt on bf out; mt rd in neck becomes dk olive below.
4. Nemea; sft lt or; rd-brn slp out; prob same, thinner, in.
5. Lerna; JA, 3rd St; hd lt rd, fn wh grts; rd-brn (dk where thk) on b bf.
6. Akrata; lt porous rd, full fn wh grts; b brnish-rd pnt on b thn wh slp (67,3).
7. Lerna; pit BE, 2cd St; fn or-rd; rd-brn mt on b yel-wh slp out; b bf in.
8. Nemea; bf, many fn wh grts; thn off-wh slp out; smth in.
9. Ayioryitika; hd med fn bf; rd-brn slp out, in neck.
10. Lerna; HTJ, Lerna I; fn hd rd; thn rd slp on bf out, in neck.
11. Franchthi; FP 49; Jacobsen 1968 pl 95b; grty or-tan; thn b rd slp, mott bl.

Fig.8.

Period I.

1. Nemea; rd b; round section handle.
2. " rd slp on bf; knob on bend, broken both ends (68, 10).

3. Nemea; or-rd b ? slp inside; smthd under; tip missing (67,10).
4. " sft or-rd; rd slp out/in, worn.
5. " coarsish red.
6. Lerna; JA JB 2cd St; spongy; rd b.
7. Nemea; fn bf; rd slp in; pnt out, too worn to make out.
8. " fn dk gr; bl & dk rd brn b out/in (67, 14).
9. " hd porous gr-bf, spgy; smth brn-bf out; strong
horiz pare marks in.
10. " gr core; thk bf outer layer chipping off; surface
eroded (68,9).
11. " gr-bff; bf skin, traces or pnt, worn (67,10a).
12. " fn sft bf, fn dk grts; rd slp.
13. " spongy, rd w gr core; mt dk rd slur out/in.
14. Corinth; LWK; med coarse bl; bl b out/in; round section
handle.
15. Nemea; hd coarse bf; rough slur out; scraped and gouged
in (68,8).
16. " rd on bf out; smthd in; spout broken (67,9)
17. " fn hd bf; rd on bf out; rd ? slp in, smth.
18. " rd spongy; v smth rd ? slp.
19. " dense hd rd bf; thk dk flaking pnt on b bf; roughish
in (67,11).
20. " hd coarse bf; rough slur out; scraped, gouged in (68,4)
21. " fn lt bf; smth lt bf out, sharp grves; scratch-
wiped in (68,5).
22. " fn yel-bf; traces rd slp in neck; outside worn.
23. " Zervos 286; smth or-rd pnt on warm b bf; restored rm.
24. Lerna; JA JB, 3rd St; hd, full big angular grts in; smth
bf slur out.
25. Nemea; hd bf, few fn grts; fn lt bf slur out; smth, few
pare-grves in.

26. Nemea; lt rd hd; glsy b rd on brn-bf; rough under (66,36).

Fig.9

Period I.

1. Nemea; bf; l b rd-brn slp.
2. " spongy; dusky rd slur out; smth bl in.
3. Lerna; pit BE, 2cd St; fn spgy cream bf, bl core; b out; smth in.
4. " pit AP, 2cd St; spgy; brn b.
5. Nemea; fn bl b out/in.
6. Lerna; J, Pebble Layer; hd rd, wh grts; thk mt dk rd slp out/in.
7. Nemea; fn lt bf; rd-brn slp.
8. Lerna; JA, 3rd St; lt bf; lt bf b out; b in.
9. " JA, 3rd St; sft grtless bf; thn b or slp.
10. Nemea; fn bf; b rd-brn slp; rim as 3,15.
11. " fn sft dk bf; b dull rd slp out/in.
12. Lerna; JA, 3rd St; fn dk gr; glsy b bl.
13. Nemea; fn bl b.
14. " hd lt rd-bf, wh grts; l b rd-brn slip out.
15. " fn bl b out/in.
16. " fn pink bf; rd-bf slp out & under; worn, pitted in.
17. " sft bf; rd slp in, worn.
18. " fn hd grtless bf; gr; glsy bl & pale mott slp out; bl worn in.
19. Corinth; 1937; smth lt bf out/in.
20. " 1937; fn bl b.
21. " 1937; v fn hd grtless lt gr.
22. " 1937; dk gr; sharp tubular perforations made before firing.
23. Nemea; sft gr-bf; bf slur out; smth dusky bf in.
24. Lerna; see 1,1.
25. Corinth; 1937; b dk gr in; b lt bf-gr out; smth lt gr under.

26. Nemea; fn hd bf; 1 b rd-brn ? slp out, and under (treated as out).
27. " fn hd bf, few wh grts; b orppnt (red where thk) on b bf out; pnt carried onto smth-pared inside.
28. " lt rd sft fn; worn rd out; same on rough inside.
29. " fn hd dk gr; bl b out; fn smth-scratched in.
30. " spgy red, bl core (c.f. 66,32).
31. " med coarse lt rd; shell grt; smthd out/in.
32. " dk rd spgy; 1 b dk rd & bf.
33. " rd, much fn silver mica, no wh; b rd-brn out/in.
34. Lerna; J, 1st St; gr grty, bf skins; smth out/in.
35. Nemea; spgyp b dk rd out; smth in.
36. Corinth; LWK; warm bf b out & .010m band in lip; bl below in.

Fig.10

Period I.

1. Nemea; dk bf spgy; b dk rd on less b dk bf; rm as 2,6.
2. " fn bf; b or-rd on b bf out; mt rd slp in; rm as 3,1.
3. " rd on spgy bf (66,21).
4. " lt rd; thk dk rd on b lt rd; rm as 4,10 (66,20).
5. " rd on smth bf; rm as 6,5.
6. " rd-bf spgy; rd on bf out; 1 b in; rm as 4,11 (66,4).
7. " rd on bf out; smth rd slp in; rm as 1,5.
8. " dk brn on bf; body.
9. " red on bf; body.
10. " thk coarse gr; brn pnt; body.
11. " dk crusty pnt, blobs from end of brush; body (66,28).
12. " rd on bf; body.
13. " rd on bf; body.
14. " rd on bf out; rough in; wall of large 4,22 (cf 66,5.12)
15. " or-rd on bf; body.
16. " rd on bf out; rough in; body (66,30).
17. Lerna; pink bf; overall rd slp over rd pnt out; rd slp in.
rm as 4,4.

18. Akrata; fn dk rd; b rd on thk b cream slp; rm as 2,2 (67,2).
19. " fn lt rd; rd on thn cream slp; prob askos frag (67,1).
20. " as 19 (67,0).
21. " as 19 (67,7).
22. " as 19, but wall of large jar (67,6).
23. Corinth; from Weinberg 1937, fig.7; Zervos 328.
24. " " " " " " " 331.
25. Lerna; J, Pebble Layer; mt bl on cream bf out; rd-bf slp in;
rm as 4,13.
26. " J D & E; lt rd, few wh grts; mt rd-brn on b cream
slp out; body.
27. Nemea; spgy brn-bf; l b dk rd pnt, mt cream over rd out;
body as 10,34 (cf 66,19).
28. " bf; b cream slp on b rd slp; rough in; body.
29. Akrata; fn hd lt or-rd; mt wh on b rd-brn out; bf-tan,
bl in; rm as 2,4 (67,4).
30. Asea; see 4,5.
31. " coarse; wh on b rd slp out; smth rd slp in; body of
big pot.
32. " or-brn spgy; smth thk wh on b rd-brn ? slp; body.
33. " from Holmberg 1944, pl. I,i.
34. Ayioryitika; sft lt rd-bf; mt cream on rd-brn slp out;
rd-brn slp in. (76,9).

Fig.11

Period II, Urfirnis.

1. Corinth; LWK; 1 lustr bl on lt bf out; bl & rd-brn slp in.
(69,23).
2. " 1937; lt pnk-gr, fn; mt thk ch slp out/in, rd below.
3. " 1937; 1 lustr majog slp out/in.
4. " Weinberg 1937, fig.18f; bichrome, ch & or pnt on
bf in; mt bl out.
5. Lerna; J-A; rd slp out; rd & bl pnt on rd-bf in.

6. Corinth; 1937; hd dk gr; mt bl slp out/in.
7. Asea; Holmberg 1944 fig.55d; lt bf; mt brshd dk mahog out;
1 lstr rd pnt in.
8. Akrata; 1085; strky brshd bl out; smth mt ch on bf in
(24,4; 72,4).
9. Corinth; 1937; strky mahog slp out/in.
10. Lerna; 1145; 1 lstr smry or-rd slp out; rd-ch pnt, thn
linear decor, in.
11. " 1382, pit BD-C; 1 lstr rd & bl slp out/in. (KDV).
12. Ayioryitika; 2268; hd lt rd; smry bl-tan-mahog mott slp
out/in.
13. Corinth; 1937; bf; strky bl out & on rm; smth bf, no slp, in.
14. " or-bf, bl strks, out; rd pnt, multiple horiz zigzags,
in.
15. Koufovouno (77,6). *Wotr Urfirnis*.
16. Ayioryitika; hd lt rd; 1 lstr rd slp out/in.
17. Corinth; 1937; rd slp, bl strks, out/in.

Fig.12

; Period II, Urfirnis.

1. Akrata; 1053; thk brshd bl out; bl on warm bf in (71,2).
2. Ayioryitika; thn slp out; or-rd pnt on bf in.
3. Tarsina; sft lt bf; rd-brn slp out; rd-brn pnt on lt bf in.
4. Koufovouno; fn bf; rd-brn stroke-b out/in. (77,10).
5. Akrata; 970; brshd mahog slp out; wide bl & thn or-brn
pnt in (24,6).
6. Ayioryitika; lt bf; bl smry slp out; 1 lstr bl smry pnt,
overslip, in (24,1).
7. " 2273; lt bf; lstrous brshd mahog slp out; bl &
mahog pnt in (24,2; 73,5).
8. Lerna; Pebble Layer, J; dull rd slp, bl patch out; bl w rd
strks in.

9. Franchthi; Jacobsen 1969, pl.97a. (KDV).
10. Ayioryitika; 2283; lt rd; 1 lstr bl slp out; bl on bf in.
11. Franchthi; F/F1 32; mt dk smry slp out; thn, brshd, in.
12. " FP 53, Jacobsen 1969, fig 6,2; 1 lstr rd-brn & dk slp out/in. (KDV).

Fig.13

Period II, Urfirnis.

1. Ayioryitika; bl pnt out, rd to mahog overslip out; mahog slp in (69,32).
2. Lerna; 1064, J-B; Zervos 325; gr, wh grts; 1 lstr gr slp, dk gr pnt. (KDV)
3. " Pit BE, 2cd Str; lt rd, wh grts; mt dk slp out/in; plastic crescent.
4. Corinth; LWK; fn lt bf; mt brn on smth bf out; brshd mt brn slp in (69,25; 74,22).
5. Ayioryitika; fn sft or-rd; bl pnt on lt rd-bf out.
6. Akrata; 1084; thn mt bl on warm bf; rest. from 3 frags.
7. Corinth; 1959; hd bl; brshd bl slp out & on rm; smth scraped in.
8. Gonia; fn lt rd; strky rd slp out/in.
9. Koufovouno; ch pnt on bf out/in; brshd mahog slp below (77,18).
10. Ayioryitika; 2274; bl pnt, brshd mahog overslop out; brshd mahog in (73,4).
11. " 2271; thk 1 lstr or-rd pnt out, thn overslop; thn or slp in.
12. Lerna; 1724, J-G; lstrous bl strky slp out/in. (KDV)
13. Franchthi; 131; lt crm, fn rd grts, pitting; 1 b and faint scratches.
14. Lerna; J 865, J-A; rd-bf; 1 lstr dk rd to mahog, undulant b marks under slp.
15. Asea; Holmberg 1944, fig 38a; hd lt rd; lt rd & bf mott, vert pared.

Fig.14

Period II, Urfirnis!

1. Klenia; 1 lustr or0rd, olive b strokes out; dusky tan tooled/pared in.
2. Ayioryitika; lt rd; bl on bf out; bl brshd in.
3. Franchthi; thn mt brn slp, tool marks.
4. Lerna; 1612; Caskey 1959, pl.41c; J-C; thk mt even rd slp out/in. (KDV).
5. " 1036, unphased; fn gr-tan to rd-bf at rim; 1 lstr slp out; plastic.
6. Franchthi; smth dusky bf, spongy.
7. Corinth; 1937; or-rd slp overall.
8. Lerna; J-E; dusky bf; thn overall slp, lightly b after slipping.
9. Klenia; fn yel-bf; 1 lstr thn brshd or & dk slp out; same mt in.
10. Asea; fn pnk-bf; rd pnt on yel-bf out; dull rd slp in.
11. Corinth; 1937; Weinberg 1937, fig.20c; ch pnt on bf out; mt mahog slp in.
12. Franchthi; F/F1 30; rd & darker pnt on b bf out; thn rd slp in.
13. " fn hd bl; lstrous deep bl slp out; tooled in.
14. Lerna; J-A; thk 1 lstr rd-brn slp out; mt olive in; plastic mark.
15. " 773, J-E; Zervos 132; 1 lstr strky rd & bl slp out/in. (KDV).
16. Ayioryitika; lt rd; rd pnt on bf out; thk dk rd in (78,6).
17. Franchthi; F/F1 36; thk crusty bf pnt out; dk mahog in.

Fig.15

Period II, Urfirnis.

1. Lerna; J-B; lstrous strky dk mahog out.
2. " J-D; fn hd bl; bl b slp out.
3. " J-A; lstrous deep rd slp, ghost (wh) pnt, out; mt slp in.

4. Corinth; 1937; 1 lstr or-mahog;out; mt dk rd-mahog in.
5. Lerna; 1391, HTN; Caskey 1958, pl.38d; brshd bl-olive on lustrous bf out. (KDV).
6. Corinth; LWK; brshd lstrous lt mahog slp out; mt rd slp in.
7. Akrata; 1080; 1 lstr bl on warm bf out; smry mt band in rm (72,2).
8. Asea; Holmberg 1944, fig.62b; coarse rd to dk; 1 b mott bl-burn-rd out (73,6).
9. Akrata; 969; fn gr; 1 lstr mott bl & tan strky slp out; 4 pellets (72,5).
10. " 1081; bl to or on bf out; plain in (72,1).
11. Lerna; 1037, J Room 15; strky slp, rd & bl patches out; rd bf in. (KDV).

Fig.16

Period II, Urfirnis

1. Corinth; 1937; bl slp w mahog streaks out/in.
2. " Weinberg 1937, fig.15e; strky dk ch slp out; or-rd in.
3. Franchthi; F/F1 20; dk bf; 1 lstr th dk slp out/in, patt b decor out.
4. Lerna; 1244; J Rm 15; olive & tan streaky slp out/in, dk pnt marks on rm. (KDV).
5. Corinth; Weinberg 1937, figs.8b. 11; or-brn w ch streaks out/in.
6. Franchthi; 125; dk slp to carination, rd below, lstrous bl strokes out.
7. Corinth; ? Weinberg 1937, fig.15; thk mt dk slp out; rougher in.
8. " 1959; rd & brn strky mahog.
9. Franchthi; F/A balk; rd, bl core; bl b strokes on dusky bf out; strky bl in.
10. Corinth; LWK 1948, pl 1b; bl pnt on bf out; thn bl to or-rd in.

11. Ayioryitika; lt bf; dk strky mahog out, & in rim; rd below in.
12. Franchthi; F/F1 32; ch on bf out; same, mt slp, in.
13. Lerna; 1227; J-C; or-rd slp out/in, inconspicuous stroke b.
(KDV).
14. Akrata; 968; th ch to or pnt on bf out; same slp in (71,4).
15. Franchthi; Jacobsen 1969, pl.95c; Theocharis 1973, pl.51;
brn-bl pnt on bf, strky below out. (KDV).

Fig.17

Period II, Urfirnis

1. Ayioryitika; 2270; or pnt on smth bf out; thk or slp on
tooled, in (70,3).
2. " 2272; smry bl on lt bf, thn overslp out; bl
& or in (70,1).
3. Franchthi; Jacobsen 1969, pl.95c; Theocharis 1973, pl.49;
brn-bl pnt & slp out, thn strky in. (KDV).
4. Asea; Holmberg 1944, fig.54b; pl.IIIb; strky bl on mt dusky
bf (70,2).
5. Ayioryitika; 2269; bl on dusky gr out; bl strky mt slp in.
(73,1).
6. " 2278; bl on bf, thn overslp out; bl & mahog
strky in (73,2).
7. Asea; Holmberg 1944, fig.49b; pl.IIIa; bl on tan, thn
overslp (70,7).
8. Corinth; 1937 fig.20a; or-rd & dk pnt on bf out; thn dk rd in.
9. Franchthi; brn spgy.

Fig.18

Period II, Urfirnis.

1. Lerna; pit BE 2cd Str; hd fn rd, mica; brshd slp, bl patches,
out; or-bf in.
2. Asea; fn hd gr core, bf skins; 1 lstr or, bl strks, out/in.
3. Ayioryitika; dk mahog strk out; thn rd & bl slp on scraped
in (73,3).
4. Asea; 1 lstr rd-brn out/in; rd-brn pnt on crm slp on rm.

5. Lerna; 1232, J-E; nr mt rd & bl smry slp. (KDV)
6. " J-A; 1 Str; thk rd slp out; mt same under lip and in.
7. " A 454, mixed fill; bright or-brn slp.
8. Franchthi; F/F1; v smth or-rd on smth bf out; thk mt overall in.
9. Argos; 8654; fn, gr core, bf skins; thn brshd rd & mahog slp out; smth in.
10. Ayioryitika; bl on warm bf (69,31).
11. Asea; brshd brn w bl patches out; rd-brn pnt on yel-tan slp on tm.
12. Lerna; 442, J, mixed fill; yel-bf; bl pnt on b lt bf out; rd pnt/slp on rim, in.
13. Ayioryitika; lt gr-bf; rd slp w dk streaks out & on rim.
14. Asea; ? Holmberg 1944, figs.52. 53a; brshd mahog out/in; or to bl on rm.
15. Franchthi; F/F1 26; ch on 1 b warm bf.
16. Lerna; J, mixed fill; bf; bl stroke b on dusky slp.

Fig.19

Period II, Urfirnis

1. Corinth; 1937. *Urfirnis*.
2. Klenia; lstrous dk slp, rd where thn (on lip).
3. Nestor's Cave; fn bf, wh grts; 1 lstr rd-brn pnt on smth bf out/in rm.
4. Lerna; 1713; tan & bl mott, w bl stroke b. (KDV)
5. Corinth; 1937; rd strky out; dk strky in.
6. Gonia; bf; lt rd slp out; dker in.
7. Corinth; lt olive-bf, dk strks, out; b or-rd in neck.
8. Koufovouno; ch pnt on lt rd out; same brshd in neck; worn.
9. " bl pnt on bf out; or-rd in neck.
10. Corinth; 1959; ch on warm bf out; dk mt slp in.
11. " Babbus Monument; bl on dusky bf (cf 69,7; 74,17).
12. Akrata; thn brshed slp, thk crazed pnt, bright rd above, bl below line.

13. Ayioryitika; strky bl slp.
14. " dk strky mahog out; or-rd in neck.
15. Lerna; 1362, pit B-D C; Caskey 1958, pl.37d; bl & rd
crackled slp. (KDV).
16. " 1381, pit BD C; Caskey 1958, pl.37e; Zervos 320;
1 lstr strky rd. (KDV).

Fig.20

Period II, Urfirnis.

1. Koufovouno; rd-mahog pnt out; or-rd in neck (77,11).
2. " or-rd slp.
3. Lerna; J-A; or-brn on bf.
4. Franchthi; bl on bf b out; thn smry mt in.
5. " F/F1 25; smth ch on bf.
6. Corinth; Weinberg 1937, fig.8c; fn hd lt bf; or to bl strky
slp out, in neck.
7. Koufovouno; mahog pnt out; strky slp in.
8. Franchthi; A 20; ch on pnk-bf out & in neck.
9. " C/C1 30; ch on warm bf out; or-rd in.
10. Ayioryitika; 2287; v dense lt gr; mt bl slp out; mt rd
rm band, olive bl pnt in.
11. Franchthi; FA unstratified; dk gr; ch on dusky bf mt slp out;
bl in neck.
12. Lerna; 728, J-A; lt rd; 1 lstr rd brn & dker; mt same in
neck.
13. Koufovouno; rd-ch pnt on bf out; lt mahog in.
14. Ayioryitika; bl on bf out; thn rd in neck.
15. Tarsina; lt rd, wh grts; dk mahog brshd slp out; thinner in.
16. Franchthi; Jacobsen 1969, pl.95b; 1 lstr rd-brn slp.
17. Corinth; 1937; sft lt rd; thn dull rd to dk out; or-rd in.
18. Ayioryitika; rd-brn pnt out; thn or slp in neck (76,4).
19. Corinth; LWK; deep mahog w bl b strokes out; duller in.

Fig.21

Period II; Urfirnis

1. Corinth; Babbus Monument; bl on dusky bf.
2. Franchthi; F/F1 35; mt rd-brn to ch on smthd bf out; same rd in.
3. Lerna; pit BE-D; bl on dusky bf.
4. Ayioryitika; bl & mahog slp, fn incised neck line.
5. Corinth; 1959; bl to or pnt out.
6. Ayioryitika; 2284; sft or bf; brn-bl on bf, thn overslip out; smry in.
7. Corinth; 1937; dk smry slp out, and down to .200m in; spattered below.
8. " LWK 1948, pl.IIa; 1 lstr or-rd pnt on smth lt rd.
9. Ayioryitika; bf; bl pnt out; bl & rd in neck.
10. Franchthi; FP 127; fn dk gr; bl b slp out; mt bl rm band in.
11. Corinth; 68-290; hd lt rd; ch pnt, lt smry overslp out; smry in (74,25).
12. Ayioryitika; 2676; sft lt rd; or-rd b slp out, same in neck; handle.
13. " 2269; hd lt rd, spongy; rd-brn slp out; scored in (70,8).
14. Asea; Holmberg 1944, fig.43; strky rd & kahog out/in; broken tab (70,4).
15. Ayioryitika (78,4).
16. " bl on pnk-bf; broken perforated flange in (76,6).
17. Lerna; J-A; hd, dusky rd, wh grts; bl mt pnt on b tan out; b tan under.
18. " g 44, unphased; hd lt rd, few sh grts; 1 lstr rd slp.
19. " 1061, J-C; Caskey 1957, pl.47d; Zervos 322; rd pnt on bf, mahog below (KDV).
20. Ayioryitika; typical urfirnis ware; rd pnt on bf (76,11).

Fig.22

Period II, Urfirnis.

1. Corinth; 1937; 1 lstr bl slp.
2. " 1937; ch pnt on thn or-mahog slp out; rough in.
3. Klenia; thk brshd 1 lstrrd to dk slp.
4. Koufovouno.
5. Lerna; J-C; lstrous brshd bl slip out; smth lt tan slp in.
6. Ayioryitika; lstrous thk bl slp out; bl & mahog strky in(76,2).
7. Corinth; 1937.
8. Tzivas-Goumaradhes; lt rd; surface worn out; lstrous bl
slp in.
9. Argos; 9663; dusky gr; dusky brn slp out/in.
10. Koufovouno; fn lt bf; or-rd slp out/in.
11. Franchthi.
12. Corinth; Babbus Monument; fn bf; brshd dk rd slp out/in.
13. Tzivas-Goumaradhes; fn lt rd; bl & or strky slp (cf 76,12).
14. Klenia; fn hd rd; smry dk & or slp out; rough under.
15. Corinth; Babbus Monument; bl on bf, thn overlâp.
16. " 1937; or-bf slp overall, except under.
17. Koufovouno; or-rd slp w dker strks out/in.
18. Corinth; Babbus Monument; rd slp, dk strks out; bl on bf
pnt decor in.
19. " horiz mahog stroke b.
20. " 1937; dense lt rd; ch strky (horiz) slp.
21. Lerna; J-B; mt rd-brn slp out; same under, rougher.
22. Corinth; Babbus Monument; bf; dk mahog slp out; perf
before firing.
23. Klenia; bf; nr mt rd slp out; smth br in & under. (cf 76,13).
24. Corinth; 68-325; hd dusky bf; lstrous dk brn slp out; smth
slurry in.
25. Koufovouno; brshd mahog out/in, thn vert b strokes; large
cut out (72,3).

26. Lerna; J-A; fn grtless bf; 1 lstr bl on dusky bf out;
same in rm, smthd below.
27. Ayioryitika; bl on bf out; roughish under w thn rd-brn slp.
28. Corinth; Weinberg 1937, fig.8e; mahog, vert stroke b out.
29. Franchthi; fn hd gr; dk stroke b out, horiz at foot & neck;
cut out.
30. " Jacobsen 1969, pl.97a. (KDV).
31. " FP 51, Jacobsen 1969, pl.97a; thk 1 lstr rd slp (KDV)
32. Lerna; 1450, ITN Late Phase; Caskey 1958, pl.38 e,f; lstrous
strky rd. (KDV).

Fig.23

Period II, Urfiænis.

1. Lerna; v. 15,11.
2. " J-C.
3. " J-c
4. " v. 19,15.
5. " v. 15,2.
6. " v. 19,15.
7. " v. 19,16.
8. " 1719, J-D; shape as 15,11.
9. " J-E; shape as 14,8.
10. " 1363, BD-C; low collar jar.
11. " shape as 14,8.
12. " J-G; shape as 14,8.
13. " v. 14,5.
14. " v. 16,4 (painted marks).
15. " v. 13,12.
16. Corinth; 1959.
17. Ayioryitika; 1 lstr even ch slp out; brshd bl in (76,8).
18. " cf 13,9 (69,29).
19. Corinth; v. 16,10.
20. " v. 19,10 (cf 69,7).

21. Corinth; 1937; thn lt ch on lt bf; pitcher rm.
22. " LWK; bl on bf; jar rm (69,21).
23. " v. 19,11 (cf 69,2; 75,6).
24. " LWK; v. 21,8.
25. " LWK; v. 21,8.
26. " v. 19,1.
27. " ch on bf; shape as 16,10 (cf 77,2).
28. " 1937; ch on tan; shape as 19,7.
29. " LWK; or & ch on bf b (69,1).
30. Kefalari; Felsch 1971, fig.3.
31. Ayioryitika; bl on bf, inside; shape as 16,10 (75,14).
32. Corinth, 1937; bl & brn on dk gr; shape as 15,4 (cf 69,42).
33. Ayioryitika; rd brn on bf; shape as 15,4 (69,30; 75,1.28).
34. Corinth; Weinberg 1937, fig.20b.
35. Franchthi; FA 11; ch on bf; shape as 17,8.
36. Corinth; Babbius Monument; or-rd on bf; shape as 15,10.
37. Franchthi; ch on pink bf; shape as 15,10 (cf 69,39).
38. " F/F1 36; ch on bf; shape as 15,5.
39. " F/F 1; mt ch on smth bf; shape similar to 16,11.
40. Lerna; Caskey 1958, pl.36f (cf 75,8).
41. Franchthi; FP 121; 1 lstr ch on bf; shape as 11,3.
42. " Jacobsen 1969, pl.96c (cf 75,22).
43. Lerna; J-B; bl-brn on bf; jar belly.
44. Akrata; 1083; bl on bf; shape as 16,14 (71,3).
45. Corinth; Weinberg 1937, fig.17,b.
46. Franchthi; H 37Ξ; bl on bf.
47. " H 37Ξ; bl on bf (cf 69,35).
48. " jar body.
49. " .
50. Corinth; Babbius Monument; ch on bf; shape as 22,18, inside.
51. " 1959; mt bl on b bf (almost Matt Paint); body frag.

52. Corinth; 1959; or brn on b dirty bf; belly frag.
53. " 1937; 1 lstr red on crm-bf; body frag.
54. " 1937; rd & ch on b rd; shape as 15,6.
55. Ayioryitika; bl w mahog band, inside; shape as 11,3 (75,21).
56. Corinth; 1937; bl & rd on bf out/in; shape as 12,3.
57. " 1937; bl & or on bf; shape as 16,12.
58. Koufovouno; ch & rd on dusky bf; base as 22,11.
59. Franchthi; F/F1 30; thn bl scribble b on dk mt slp.
60. Corinth; 1937; bl on bf; shape as 14,14.
61. " Weinberg 1937, fig.19,b; dk b lines on dk brn-bl
mott slp; as 16,10.
62. Lerna; HTN; dk strokes on or-brn slp; rm similar to 15,5.
63. " J-G; pattern b; on rm as 15,5.
64. " J-G. pattern b; on rm as 15,5.
65. Ayioryitika; ch on bf (69,44; 78,5).
66. Franchthi; FP 54, Jacobsen 1969, fig.6,4; bl on bf.
67. Corinth; 1937; v. 22,7.
68. " 1937; bl on dk bf; section as 23,66.
69. " 1937; ch on bf; as 22,15.
70. " 1937; ch on lt bf.

Fig.24

Period II, Urfirnis.

1. Ayioryitika; v. 12,6.
2. " v. 12,7.
3. Franchthi; FP 119, sketch only.
4. Akrata; v. 11,8 (72,4).
5. Corinth; LWK; frag of large bowl, restored.
6. Akrata; inside of 12,5; wide bl lines and narrow or-brn
lines on bf.
7. Asea; restoration on paper of Holmberg 1933, fig.55a,b.

Fig. 25

-Period III, Black Ware

1. Alepotrypa; fn hd bl; bl & tan out; nr bl b in.
2. Corinth 1937; dense bl stone; bl b out; dk strky in.
3. " 1937; dk brn b out; notched lip.
4. " 1937; dk b out/in.
5. " 1937; crse hd; bl b out; brn in.
6. " 1937; dk b out/in.
7. " 1937; sft lt pink bf; fn dk brshd slp out/in.
8. " 1937; bl b slp.
9. " 1937; rd brn b out; bl pb in.
10. Alepotrypa; dk gr; bl b out/in.
11. " dense bl stone; bl b out/in.
12. Corinth Forum West, 70-248; fn hd; bl b out/in; strky tan out.
13. Alepotrypa; bl stone; bl b out/in.
14. Corinth 1937; bl; bl b, thn parallel strokes, vert out, oblique in.
15. " 1959; fn hd; nr bl b out/in.
16. Nestor's Cave; fn bl, red skins; thn bl brshd slp; wh pnt on lip.
17. Corinth Forum West, 70-246; bl b out; smth gr in; lt gr crsty pnt out.
18. Corinth Forum West, 6489; hd bl; bl b out & lower in.
19. Koufovouno; fn dk gr; v lstrous bl b, clear marks.
20. Corinth Forum West, 70-245; dense bl; bl b out/in.
21. Franchthi F/A 117N; fn hd bl; strky bl b out; scraped in.
22. Corinth 1937; fn; bl b out; med gr smth in.
23. " 1937; nr bl b out; smthed in.
24. " 1937; sft lt pink; brshd bl slp out, crisscross.
25. Alepotrypa; dk lumpy; dk mahog b out (101,20).
26. Corinth Forum West 70-354; hd dsky bge; tan & dk b out; dk tan b under.

27. Corinth Forum West 70-226; fn crm, bl skin out; bl b, tan patches out; crm in.

Fig. 26~~Period III. Black War~~

1. Corinth 1937; gr core; bl b out; gr in.
2. " 1937; bl b out/in; fnt burn ripple.
3. " 1937; bl & tan mott, ghost pnt out; b or-gr in.
4. " 1937; bl b out/in.
5. " 68-299; dense fn bl; silvery bl b out; smth in.
6. " 69031; dense fn bl; silvery bl b out; smthed in.
7. Franchthi F/F1 bask 22; hd porous bl; strky bl b, ghst pnt out/ strky bl in.
8. Corinth Forum West 6487; bl b out/ strky in.
9. Corinth 1959; dense fn med gr; thn brshd bl slp out/in.
10. " 1937; gr; graces dk b out; gr slur in.
11. " 70-285; dense bl; bl b, wh pnt out.
12. Klenia; bl b out/in; fn oblique burn grves; traces wh pnt; handle root.
13. Corinth 70-242; dense bl; bl b out/in; fn dk crusty pnt.
14. " 68-168; fn hd tan-gr; dk b, wh pnt out; less b in.
15. " 1937; dk gr; dk brn b out.
16. " 1937; bl b.
17. " 1959; dense hd dk; dk brn b out/in.
18. Franchthi EP 110; hd porous dk to rd; glsy b bl-mahog-tan out; dk tan pb in.
19. Corinth 1937; bl out (worn); gr in.
20. " 1937; pink core; bl b.
21. " 1937; bl b.
22. " 1937; bl b.
23. " 1937; med fn gr core; dk gr slur out/in.
24. " 1937; bl b.

Fig.27Period III, Black Ware.

1. Asea; bl, bf skins; b brn tan w bl strks out/in.
2. Franchthi F/F1 b. 20; dense fn gr; glsy bl b, gr top out;
scrib b in.
3. Corinth Forum West 6479; fn bl b out/in.
4. Corinth P. of Apollo; fn dense dk gr; bl b out/in; pellet.
5. Asea fig 48; hd fn bl; patchy bl b out/in; ghost ?wh pnt.
6. Corinth 70-330; BCH 95, 1971, 857. fig.117; bl b.
7. " 1937; bl b out/in.
8. " 1937; tan bf, bl b strks & patches out/in.
9. " LWK; dense gr; tan b out; tan w bl patches in.
10. " 1937; bl b out/in; traces scratched decor.
11. " 1959; 143; bl b, plastic strip.
12. " 1937; bl & bf, incised decor out; bl b in.
13. " 1937; bl & bf, grve decor out; dk gr smth in.
14. Argos C 8615; lt rd, wh & dk grts; dk rd strky slp out in.
15. Corinth 1937; fn rd-brn brshd slp out/in/under.
16. Klenia; dk hd crse; bl smth slur out/in (93,4).
17. Corinth 1937; or rd; rd slp out/in; grve decor.
18. " LWK; bl b out/in, tan patch under; grve decor.
19. Klenia; dense gr, med grts; bright rd b slp, rim incised.
20. Corinth Forum West 6490; dense bl; bl b out/in.

Fig.28Period III, Black Ware.

1. Corinth 1937; dk gr; glsy bl b slp out; tan in.
2. Corinth Forum West 70-291; v fn dk gr; b tan smry out/in;
reserve ?wh pnt.
3. Corinth 1937; bl b below rm out; smth crm-gr-bf on rm & in.
4. Alepotrypa; hd fn porous bl; bl b out & in rm.
5. Corinth Forum West 70-151; bl & dk rd/mahog mott b out; smth
bl in (92,5).
6. Corinth Forum West 6479; bl b.

7. Corinth Forum West 70-215; or-rd to dusky, overfired; worn
bl out/in; faint ripple & bead decor.
8. Corinth Forum West 70-143; bl b, tan patch out.
9. Koufovouno; dense brn, little quartz, grog, wh grts; dense
mt bl slp out/in.
10. Corinth P. of Apollo; dense dk gr, bl, wh grts; traces glsy
bl b slp; fn incised wh filled decor; traces
red pnt under lip.
11. Corinth Forum West 70-332; dense dk fn; glsy bl & dk tan b,
wh pnt.

Fig.29Period III, Black Ware.

1. Corinth Forum West 70-271; dusky & rd; tan & bl b, tn wh pnt
out; rd brn in.
2. Klenia; bl b out in; reserve matt ?pnt line out.
3. Franchthi F/A balk 117N; fn bl; bl b, ghost pnt out; l b gr in.
4. Corinth Forum West 70-547; fn dk gr; bl b, wh crsty pnt out;
dk gr in (92,2).
5. Corinth 1937; bl b out & in rm; dk brn below, in.
6. " 1937; bl b.
7. " 1937; lt rd core; bl b out/in.
8. Franchthi F/F1 b.22; bl; patchy bl b, wh pnt out.
9. Alepotrypa; dense bl; smthed bl out/in; (Hauptmann 1971,fig.54)
10. Corinth 1959 177; bl; bl b, fn tool marks out.
11. Alepotrypa; fn bl; glsy bl b, gr patches & strks.
17. " Hauptmann 1971, fig.54b; fn gr; b bl-gr-crm
mott out; gr in (90,1).
13. " lt rd, bl skins; dk brn to bl b out; tan to
bl in.

Fig.30Period III, Grey Ware,

1. Corinth 1937; gr.
2. " 1937; dk brn; notched lip.

3. Corinth 1937; grn-gr; notched lip.
4. " 1937; gr.
5. " 1937; fn gr.
6. Klenia; grnish gr.
7. Corinth 1937; med fn gr; dk gr out; smth gr in.
8. " 1937; roughish gr.
9. " 1937; fn hd lt gr; l shine out/in; dk purplish-rd
mt pnt on rm.
10. " 1937; fn gr; notched lip.
11. " 1937; gr.
12. " 1937; gr slur out/in.
13. " 1937; gr.
14. " 1937; gr; notched lip.
15. " 1937; gr.
16. " 1937; gr; shallow notched lip.
17. Klenia; hd fn; dk gr b out/in.
18. Argos; gr w tan tones, smth.
19. Klenia; sft med gr; l b out/in; fnt rippling; broken
pedestal ground smth.
20. Corinth 1937; gr.
21. Klenia; med gr.
22. Corinth 1937; smth bf gr; lt paring marks; rough under.
23. Alepotrypa; lt gr, crse grts; wll b; incised after firing
(? recent).
24. Corinth 1937; gr slur.
25. " 1937; md dk gr slur; tool marks in.
26. Klenia; dk gr b out; rough under (91,5).
27. Corinth 1937; dk gr-tan.
28. " 1937; gr.
29. " 1937; crse, sft; smth bf-gr.

Fig. 31

Period III, Grey Ware.

1. Corinth 1937; fn gr slur out/in.

2. Corinth 1937; crm gr slur.
3. " 1937; gr smthed out; smth in.
4. " 1937; gr b out; smth in.
6. Argos C 9484; med gr, wh grts, mica; smth out/in.
7. Corinth 1937; gr.
8. " " gr; vert pierced lug.
9. " " smtn gr out/in.
10. " " dk gr b out/in.
11. " " gr; shallow grves in rim.
12. " " smth bf gr.
13. Klenia; med crse; bl b.
14. Corinth 1937; smth gr; fnt b lines; root of high handle.
15. Klenia; gr.
16. Corinth 1937; gr.
17. " 1937; gr; smth out, marks in; scratched/stamped
decor; notched rm.
18. " 1959; fn dk gr b out; smth in; shallow grves.
19. Klenia; med gr.
20. Corinth 1937; dk gr smth out/in; vert incisions, spacing not
sure.
21. " 1937; fig 27d; cf Zervos 375; lt gr.
22. Klenia; med dk gr, fn wh grts; l b out/in (91,1).
23. Corinth 1937; fn med gr; tan to tan-gr b out; lter in; incised.
24. " 1937; fig 27a; Zervos 377; as 23.
25. Klenia; dk gr b out; smth in.
26. Corinth 1937; med gr.
27. " 1937; dk out; gr in; scratched.
28. " 1937; gr; pricked rim.
29. " 1937; fn hd med gr; b.
30. " 1937; fig 27b; Zervos 376; med fn gr; as 23; græves.

Fig. 32

Period IV, Grey Xara.]

1. Corinth P. of Apollo; dense bl; dk gr out; lt gr in; mend hole
2. Corinth 1937; gr slur out; smth in.
3. Klenia; lt gr; fnt vert rippling (91,4).
4. Corinth 1937; gr slur out in.
5. Klenia; lt gr.
6. Corinth 1937; dk gr smth.
7. " 1937; dk gr b.
8. " 1937; fn gr.
9. " Lechaion Road; fn gr; bl pnt out/in.
10. " 1937; fn gr.
11. Klenia; med gr b out; l b in (91,8).
12. Corinth 1937; dk b out; lt gr slur in.
13. Franchthi; Jacobsen 1973b, fig 5,2; fn Corinthian gr.
14. Corinth 1937; gr.
15. " 1959; fn dense silvery gr.
16. " 1959; fn gr.
17. Klenia; fn med gr.
18. " v fn dense med gr; b out/in/under.
19. Corinth Forum West 6479; med lt gr; crm patch out; crm tan in.
20. " 1937; v fn gr; gr slur out/in.
21. " 1937; gr; vert perf lug.
22. " 1937; fn lt tan b, wh marbling.
23. " 1937; lt gr rough; perf tubular lug.
24. " 1937; fn gr b out; shallow oblique rippling.
25. " 1937; gr.
26. " 1937; gr; fnt vert rippling; lip restored.
27. " 1937; fn gr; b out; slur in.
28. Klenia; dk fn gr b out; l b in.
29. Corinth 1937; hd gr; wh marbling.
30. Corinth LWK; fn lt gr; fnt vert rippling (90,8).

Fig.33 Period III, Grey Ware.

1. Corinth 1937; fn gr; grve decor.
2. Klenia; med gr b; oblique fluting (91,3).
3. Corinth LWK; v smth lt gr out/in (90,9).
4. " 1937; fn gr.
5. Klenia; med fn gr.
6. " as 5, plastic strip (91,10).
7. " dk gr b; strap handle.
8. Corinth 1937; fn gr; b marks out; scraped in; hndle root.
9. Klenia; med lt gr.
10. Argos, C 9484; fn med gr.
11. Klenia; v fn med gr; l b out; fn scratched in; hndle root.
12. Corinth 1937; gr slur out; rough in.
13. " 1937; fn gr.
14. Klenia; med gr; fnt oblique rippling.
15. Corinth 1937; smth bf gr out/in; wide handle.
16. Klenia; v fn hd dk gr.
17. Klenia; med gr; b out; smth pared in.
18. Corinth 1937; smth gr out; wiped in.
19. " 1937; smth gr out; less in.
20. Gonia aXI; med gr b, dker patches.
21. Tarsina; hd dusky gr, crse grts; dk gr b out; dusky tan in.
22. Klenia; dense fn dk gr; dk gr b out; scraped in.
23. Corinth 1959; lt bf core, bl skins; smth tan gr out/in.
24. Klenia; dk gr b out & in rm; handle root.
25. " med gr.
26. Corinth LWK; dk gr b, shallow grves out; med gr in.
27. Klenia; v fn hd; dk gr b.

Fig.34 Period III, Grey Ware.

1. Corinth 1937; gr; as 33,26.
2. v. 31,30.

3. v. 31,21.
4. v. 31,27.
5. Klenia; large, thick; as 31,11, shallower.
6. Corinth 1937; as 31,27.
7. v. 31,24.
8. Corinth 1959; bl, gr patches; body.
9. " 1937; as 31,18.
10. " 1959; fn dk gr; as 31,27.
11. v. 31,17.
12. Argos C 8559; dk gr; incised and dotted; as 31,27.
13. Corinth 1959; smth gr; as 32,26.
14. Klenia; med gr; grved handle.
15. Corinth 1937; lt gr; grves.
16. v. 31,20.
17. Corinth 1959; gr bf b; incised, plastic motif.
18. v. 31,27.
19. Corinth 1937, fig 27,b.
20. " 1959; dk gr; fn incised; body.
21. " 1937; fn gr; shallow fluting.
22. " 1937; gr; narrow shallow rippling.
23. Klenia; med gr; fn rippling.
24. Corinth 1937; gr; fluting; as 33,14.
25. " 1937; lt grn-gr b; thn brshd slp; shallow fluting.
26. " 1937; gr; wide shallow fluting.
27. " 1937; med gr; shallow fluting; pedestal wall.
28. " 1937; fn gr; faceted lip.
29. " 1937; fn gr; scalloped lip.
30. " 1937; fn gr; incised lip.
31. Lerna; bl b; fn ripple and bead (sketch).
32. Corinth Eorum West 70-239; bl b; 1 ripple and bead.
33. Corinth 1937; gr.

34. Corinth 1937; gr; vert perf lug.
35. Corinth LWK; dk gr; vert perf lug.
36. Klenia; med gr; on pedestal bowl.
37. Corinth 1937; lt gr slur out; roughish in; spout broken at end.
38. Klenia; med gr.
39. Corinth 1937; fn gr.
40. " 1937; fn gr.
41. " 1937; fn gr.
42. " 1937; fn gr.
43. " 1937; fn gr.
44. " 1937; tan bf b out/in.
45. " LWK; med crse gr, quartz; gr b out, tan patch.
46. " 1937; med fn, hd; traces dk gr b out.
47. " 1937; gr; smth on top; break scar under.
48. " 1937; gr.
49. " 1937; gr.
50. " 1937; gr.
51. " 1937; rough dk gr ripple b out; smth gr slur in.
52. " 1937; gr.
53. " 1937; gr.

Fig. 35 Period III, Black & Grey Ware

1. Corinth Forum West 6478; wh on bl b out; tan in.
2. Corinth 1937; wh on bl b; cf 29.1; 92,4; as 26,2.
3. " 1937; ghost on bl b; cf 26,6.
4. " 1937; fig 22g; wh on bl b out; tan in.
5. " 1937; wh on bl b; as 26,15.
6. " 1937; ghost on bl b.
7. " LWK 1951, pl.4.
8. " 1937; ghost on bl b.
9. " = 29,4; 92,2.
10. " 1937; wh on med gr slur.
11. " = 26,13.

12. Franchthi = 29,8.
13. " F/F1; wh on bl b.
14. " = 26,7.
15. " = 29,3.
16. Corinth Forum West 70-292; bl pb inside open bowl.
17. " " " 70-357; fn bl pb, body.
18. " " " 70-283; bl pb, thick body.
19. " " " 70-228b; fn bl pb, body.
20. " LWK; lt gr; mt purplish pnt line; d. .260.
21. Argos C 8578; med gr, traces dk b & rd-brn pnt out; lt gr
smth in.
22. Corinth 1937; bl mt on dk gr; jar shoulder.
23. " 1937; thk mt bl pnt on dk gr w tan tinges; rough tan in.
24. Klenia; lt gr; rd-brn pnt, overall b; d..160 (95,15).
25. " med gr; glsy bl pnt (95,14).
26. Gonia aVI; dense dk gr; mt dk violet pnt on b tan out.
27. Corinth Forum West 70-473; fn Grey on Grey; cf 92,6.

Fig.36~~Black on Red.~~

1. Corinth Forum West 70-331; mt bl on l b rd slp (17; 80,1).
2. " 1959; bl on rd b slp, in.
3. " 1937; bl on rd slp, out and in rm.
4. " Forum West 70-230; b lt brn-rd; traces brn pnt out/in.
5. Gonia (BSA); thn smth bl pnt on rd b slp, dker in parts.
6. Corinth 1959; mt bl on bright rd b slp out/in.
7. " Forum West 70-540; bl on rd slp (50,3).
8. " 1937; bl on rd.
9. " Forum West 6491; lt rd; bl mt pnt on rd slp in &
? once out on rm.
10. " 1937; bl mt on crazed rd brn slp (cf 80,2 from Forum
West).
11. " Forum West 70-247; fn rd; thn bl pnt under rd mt
brshd slp.

12. Corinth 1937; thk rd slp out; bl on rd in.
13. " 1937; mt bl on b rd-brn, out & in lip.
14. " 1937; bl pnt on rd slp out; bl slp in; high handle root; d .150m.
15. " 1959; bl on or-rd slp; pedestal.
16. " 1959; mt bl on or-rd b slp out; mt rd slp on pitted surface in.
17. Decor inside 1 (80,1).
18. Corinth 1937, fig.14a; lt rd-bf; thk bl-mahog slp out; rd-brn l lstr slp in.

Fig.37

Matt Painted.

1. Corinth 1937; bl on l b lt gr-bf.
2. " 1937; ch on warm bf out/in; multi-chevrons.
3. " LWK; dense lt pink; gr ghost pnt on b bf in.
4. Franchthi; Jacobsen 1973b, fig.7,15; pl.51a; lt rd; or to ch mt on l b.
5. Corinth 1937; fig 32c; lt rd; l b ch on l b pink-bf.
6. " 1937; ch rn band on grnish crm.
7. " 1937; dk ch rm bnd on lt bf.
8. " 1959; bl on rd-bf, worn.
9. Asea, fig 77j; mt bl on smthed warm bf; same out.
10. Corinth 1937; ghost pnt on lt bf.
11. " 1937; ch on grnish crm in.
12. " 1959; dk ch on lt grnish crm in; l b out.
13. " 1937; ch on grnish crm out; ch on lt bf in.
14. Gonia aVIII; bl mt on smth pink bf in.
15. Corinth Forum West 6478; fn bf to lt gr; brn pnt on ? crm slp.
16. " 1937; ch strky pnt on smth gritty crm.
17. Gonia aXI; l b warm crm-bf, fnt pnt lines in.
18. Franchthi; fn dense lt rd; or-rd pnt on smth warm bf (close to Urf.).
19. Klenia; hd porous bf; thn mt ch on b yel-tan (88,3).

20. Corinth 1937, fig.31c; mt ch on fn warm bf (cf 88,3).
21. " LWK; lt gr, pnk skins; dk rd pnt.
22. " 1937; fig 31a.
23. " 1937; dusty mauve on grnish crm.
24. Alepotrypa; fn sft lt crm; traces rd pnt, v worn (101,18).
25. Corinth 1937; fig.31f; ch on yel-bf.
26. " 1937; mt bl on warm bf out; brshd smeary under, to dotted line.
27. " Forum West 70-294; lt gr core, rd-bf skins; l b out, no paint.
28. " 1937; bl pnt on warm rd-bf.
29. " 1937.
30. " 1937.

Fig.38

Matt Painted.

1. Gonia EtaIII/IV; lt pnk core; lt yel-bf, v worn.
2. " aX; lt rd; dk ch on grnish crm.
3. Corinth 1937; dusty mauve on lt grn-crm.
4. " 1937; or-mauve on lt bf.
5. " 1937; dk ch on rd bf.
6. Argos C 8698; lt rd; thn dk mauve pnt out, & on pnk-crm slp in.
7. Corinth 1937; ch on grn-crm rm band; angle not sure.
8. " Forum West 70-224; thn brn mt on smth yel-crm (86,3).
9. Argos C 9416; thn mauve pnt on dusky bf.
10. Klenia; ch on grn slur out/in.
11. Corinth 1937; dk ch on lt yel-bf.
12. Klenia; crse crm, large grts; bl rm blobs on rough slur.
13. " lt rd; surfaces worn.
14. Corinth 1959; dusty mauve on warm bf.
15. " 1937; gr core, pink bf skins; traces rd slp/pnt out.
16. Klenia; lt rd; mt ch on l b bf-crm out; smthed in.
17. Argos C 9462; Daux 1967, fig.31, centre; brn-bl pnt on smth bf.

18. Klenia; hd lt rd; mt bl on bf slur out; smth warm bf in.
19. Corinth 1937; dk ch on grn-crm out; grve rm.
20. " 1937; ch on lt bf out/in.
21. Klenia; crse, roughly made, grnish.
22. " lt rd crse; smth bf slur; dk rd pnt out; same pattern in.
23. Corinth 1937; lt rd; mauve on lt yel-crm in; plain out.
24. Gonia (BSA); crse bf; mt rd on rough slur out.
25. Klenia; rd; rough l b out; smth in; b verm pnt out/in.
26. Corinth 1937; c pnt on lt grn crm out.
27. " Forum West 70-219; rd; smth dusky & rd mott slur; thn yel-brn pnt.
28. " 1937; sft lt rd; rd pnt out; traces in.
29. " 1937; dusty mauve on lt grn-crm.
30. " 1937; lt rd; rough slur out/in; careless pnt lines out.
31. " Forum West 70-558; rd; l b ch on l b warm bf (85,7).
32. " Forum West 70-299; ch on l b bf (86,1).

Fig.39.

Matt Painted.

1. Klenia; lt rd; bl mt on l b crm slp out/in.
2. Asea, fig 77a; sft bf; mt rd pnt on lip; smth out/in.
3. Corinth 1937; ch on warm bf.
4. " 1959; bf, many wh grts; dusty ch on crm out/in (4a).
5. " 1937; cn on rd-bf.
6. Franchthi, Jacobsen 1969, fig.7,3; gr core, bf skins; mt dk brn on l b.
7. Corinth 1937; mauve on lt crm out; d. .220m.
8. " 1937; dk ch on rd bf.
9. " 1937; ch on lt bf.
10. " 1937; mt pnt.
11. " Forum West 70-217; dense gr, bf skins; thn smry bl pnt out/in.

12. Klenia; mt bl on l b yel-bf.
13. Corinth (BSA); hd gr core, rd skins; bl mt pnt on l b dusky slurry.
14. " 1959; crusty bl on l b.
15. Gonia; v fn sft lt crm.
16. Corinth 1959; 59-22; dk ch on l b yel-crm.
17. " 1937; ch on yel-crm out.
18. Klenia; hd dense bf.
19. Corinth 1937; ch on lt crm out.
20. " 1937; smth lt grn-crm; wiped in.
21. " 1937; ch on warm bf; rm grve.
22. " Forum West 70-218; lt rd; mt brn on b crm-pink-bf (86,2).
23. " 1937; mauve on lt grnish-crm.

Fig. 40

Matt Painted.

1. Corinth LWK; crm; thn mauve wash out; wavy line in.
2. " LWK; lt pink, dk grts & grog; mauve on lt grnish-crm out; bf slur in.
3. " P. of Apollo; lt bf; fnt mauve on b bf out; lt yel bf in.
4. " Forum West 70-289; pink bf; mt brn pnt on l b bf (86,4).
5. " 1937; ch on lt grn-crm out.
6. Klenia; gr core, rd skins; bl mt on l b rd (87,2).
7. Corinth 1937; ch on warm bf out.
8. " 1937; bl on rd-bf, worn.
9. Klenia; l b rd out; fn scratched in.
10. Corinth LWK; pink core, crm skins; smry purplish pnt in slur.
11. " Forum West 6487; rd brn on smth warm bf.
12. Klenia; mt bl on l b yel-bf.
13. Corinth 1937; ch on bf.
14. " 1937; mauve on l b bf rd.

15. Corinth 1937; ch onlt bf.
16. " 1937; or-rd; crm-bf slur slp, traces pnt.
17. Franchthi, Jacobsen 1973b, fig.7,8, pl.51; dk gr core, bf skins; crusty pnt.
18. Argos; fn hd crm, dk strks; thn rd-brn pnt.
19. Corinth 1937; lt yel-crm, pnt worn.
20. Franchthi, Jacobsen 1973b, fig.7,9; spongy bf; dusty ch on smth mt.
21. Gonia; dk ch on lt crm-bf, poss slp.
22. Klenia; crse gr; dk & yel-bf mott; bl mt pnt.
23. " fn yel-bf; mt bl on l b crm-bf out; smth bf in.
24. Corinth 1937; sft fn bf; dk ch mt pnt (cf 84,9).

Fig.41

Matt Painted.

1. Corinth 1937; lt bf; traces pnt, worn.
2. " 1937; ch on lt yel-crm.
3. Corinth Forum West 70-557 (85,5).
4. " 1937; mauve on warm bf, worn.
5. " 1937.
6. " 1937; mauve on grnish crm; pattern as 43,5.
7. Klenia; mt bl on smth yel-bf.
8. " mt bl on b crm bf.
9. Corinth 1937; bl on dusky gr slur.
10. " 1937; lt bf; worn pnt, as 43,5.
11. " 1937.
12. Klenia; dusty mauve on crm slp (81,18).
13. Alepotrypa; Hauptmann 1971, fig.48b; fn bf; dk ch on thn crm slp (82,2).
14. Corinth 1937; fig.32,d; lt rd; ch on crm slp.
15. " 1937; bl on pink bf; 2 horiz zigzag lines.
16. " 1937; ch on warm bf.
17. Klenia; overall mt bl except handle, w 2 stripes.

18. Alepotrypa; Hauptmann 1971, fig.47a; pink bf; bl on thn
wh slp (82,6).
19. Klenia; crusty bl pnt on yel-bf.
20. " lt rd bf; lt crm slp out (81,17).
21. Corinth Forum West 70-358; crazed bl on smth crm slp.
22. Alepotrypa; Hauptmann 1971, fig.54a; lt rd; bl mt on thn
wh slp.
23. Corinth LWK; dk purple pnt on l b crm slp out; rough in,
verm wash.
24. " 1959; dense yel; wipe marks out; dk mauve pnt on
hndle & in.
25. " 1937; ch on grn-crm out.
26. " 1937; mt bl on wh slp, as 37,23.
27. " 1937; fn hd crm; mt ch pnt, worn.

Fig.42£

Matt-Painted.

1. Klenia; bl on l b warm bf.
2. " mauve on warm crm (81,13).
3. Corinth LWK; fn sft bf; crm slp out/in.
4. Corinth LWK; roughly made, crm bf; strky mt mahog pnt in.
5. Alepotrypa.
6. Akrata; hd overfired crm-gr, blistered; bl mt on thn wh slp
(89,2).
7. Corinth 1937; ch on lt bf.
8. Alepotrypa; lt bf; rd brn pnt on l b slur (82,7).
9. Klenia; dense crm bf; mt bl on rough crm slur; yel-brn on
hndle (88,6).
10. Alepotrypa; thn mt purple & incised lines in wh slp.
11. " Hauptmann 1971, fig.47c; bl on crm slur (82,5).
12. Corinth Forum West 70-243; smry bl on yel-crm.
13. Alepotrypa; Hauptmann 1971, fig.48b; ch on thn brn ?slp (89,6).
14. " Hauptmann 1971, fig.45b; bl on thn wh slp.
15. " Hauptmann 1971, fig.47b; bl on wh slp.

Fig.43

Matt Painted.

1. Klenia; inside of 87,3.
2. Corinth Forum West 70-560; ch on l b ivory; as 39,20, lip
grve (85,6).
3. " 1937; crusty bl on crm; piriform jar.
4. " 1937; pedestal ft.
5. " 1937; mauve on lt bf; jar collar; cf 85,18.
6. " LWK; ghost mauve on yel-bf; as 40,10.
7. " Forum West 70-223; crusty brn on smth bf slur; same
lip as 38,26.
8. Klenia; = 87,3; bl on l b rd; band of 43,1 in; as 38,7.
9. Gonia aX; nt rd on warm bf out; vert rm.
10. Klenia; ch on grn-crm in; as 38,5; (81,14).
11. Corinth 1959; ch on grn-yel; inside & out as 39,16.
12. " Forum West 70-549; sim 38,32; (85,13).
13. " Forum West; sim 38,32; (85,14).
14. " 1937.
15. " 1937.
16. Gonia pl.Ie; bl on crm.
17. " eIV; mauve on warm rd; pedestal as 37,26.
18. " aXI; dusty mauve on b tan; as 39,1 (cf 84,7).
19. " aVIII; thk mt verm on rd in; rm as 38,32.
20. " aII; mt verm on dusky bf out; jar collar.
21. Corinth 1959; 59-18; ch on lt grn-crm, as 39,7.
22. " 1937; fig.32e; as 41,4.
23. " Forum West 70-530; dk brn-mauve on yel-crm; as 37,17
(84,3).
24. " 1937; bl on bf; as 37,15.
25. Alepotrypa; watery dk brn on smth crm-bf slur; as 42,7; (89,1).
26. " as 42,13.
27. Klenia; rd; bl on crm slp; as 42,14; (88,4).

28. Corinth Forum West 70-548; brn on crm; as 41,7; (85,16;
cf LWK 1951, pl.4b).
29. Klenia.
30. Corinth 1937, fig.32g;
31. Gonia aXI; ch on honey bf b; fn body.
32. Alepotrypa; mt bl on l b bf; jar belly.
33. " jar shoulder; (82,12).
34. " Papathanasopoulos 1971b, pl.IV.
35. Gonia, pl.Ic.
36. Corinth 1937, fig.31g.
37. " 1937; ch on pink bfl jar shoulder.
38. Klenia; ghost pnt on high b lt crm; belly as 41,14; (81,19).
39. Corinth 1937; ch on lt grnish crm; large jar wall.
40. Gonia pl.1a; mauve on crm.
41. Corinth 1959; mauve on yel-bf; jar belly.
42. Gonia aVII.
43. " eIV; ch on rd-bf.
44. Klenia; l lstr bl on l b bf; jar shoulder; (82,10).
45. Corinth 1959; ch on lt bf, overall b (urf/matt paint), out.
46. " 1959; inside of 45.
47. " Forum West 70-531; bl crusty on grn-crm; jar collar
(84,4).
48. " 1937; Zervos 400; smth ch pnt on b bf.
49. " 1937; ch on rosy bf.
50. " 1937.
51. " LWK; mt brn mauve on l b crm; as 37,2.
52. " 1937.
53. " 1959; lstrous, brshd ch on pink bf, part mt (urf/matt
paint).
54. " Forum West 70-554; ch on lt rd; low collar jar, as
41,19 (85,17).
55. " 1959; bl on lt grn-crm; jar belly.

56. Klenia; bl on high b warm bf (87,12).
57. Alepotrypa; mt dk slp, dker pnt; collar jar (82,10).
58. Corinth 1937.
59. " Forum West 69-292; mauve on warm bf, in; as 39,20.
60. " 1937, fig.31d; Zervos 399.
61. " 1937, fig.32a; Zervos 400.
62. " Forum West 70-555 (85,10).
63. " 1937.
64. Klenia; dk mt on crm slur.
65. Gonia aXI; bl pnt on crm fabric.
66. Klenia; dk pnt on grn-crm.
67. Alepotrypa; bl mt on thn wh slp (42,10).
68. " dk mt on thn brshed wh slp.
69. " = 42,15.
70. Argos C 7537; ch on crm.
71. " C 9594; ch on yel-crm.
72. Alepotrypa; dk ch on thn crm slp (41,13).
73. " = 42,13.

Fig.44

Polychrome:

1. Corinth 1937, fig.33g; mt or & bl on crm.
2. Gonia EtaVIII; rd & bl out; strky b in, fire darkened.
3. Corinth 1959; glsy or-rd & mt bl on l b yel-bf out/in.
4. Gonia aIII; rd & bl on bf out; traces decor in.
5. " aV; l b rd & mt bl on l b ivory.
6. Corinth 70-94; v smth lt bf out; l lstr bl & thn rd on l b
lt rd in (87,1).
7. Gonia aI; dp rd & mt bl on dusky crm (83,23).
8. " aX; decor out/in but worn.
9. Klenia; b dp rd & mt bl on l b bf.
10. " dp verm & mt bl on l b yel-bf out/in.
11. Gonia eIV; bl & rd on bf.

12. Gonia FVII; dk & lt brn on crm out; 1 b bl & mt brn on 1 b dusky wh in (83,13).
13. " EtaI; rd & bl on lt bf-crm in; worn out.
14. Klenia; lt rd; verm & bl on b dusky bf out.
15. " rd & bl on yel-bf; roughly made; (88,2).
16. " b bl & dp rd on b dk rd; rest from several frags.
17. Gonia aII; rd & bl on pink-bf; rest from several frags.
18. Corinth 1959; crusty cherry & thn bl on or-bf.
19. Gonia aIII; thk dk mahog & bl on 1 b bf (83,22).
20. " EtaVII; 1 b rd & mt bl on crm-bf (83,11).
21. " aV; b or & mt ch on b bf (83,12).
22. Klenia; fn dense rd; decor out v worn.

Fig.45

Polychrome.

1. Klenia; dp rd & mt bl on 1 b pink bg out.
2. " 1 lstr rd & bl pnt on 1 b yel-bf.
3. Corinth Forum West 70-270; mt ch & rd on smth crm-bf.
4. Klenia; dp verm & mt bl on dusky bf.
5. " rd-brn & bl on 1 b bf.
6. Gonia aVI; rd & bl on lt bf out.
7. Klenia; hd bf; lstrous dp verm & mt bl on bf.
8. Gonia aVII; rd & bl on 1 b crm slp.
9. Klenia; dense bf; lstrous verm & mt bl on 1 b bf (81,23).
10. " dp rd & bl pnt.
11. Alepotrypa; rd & thn mauve on warm bf (82,8).
12. Corinth Forum West 70-233; rd & bl on bf.
13. Gonia; etaVII.
14. " aIII; rd & bl on lt bf (83,14).
15. Corinth 1937; fig.33 e; or & bl on crm-bf slur.
16. Klenia; gr core, rd skins; lstrous rd & mt bl on 1 b bf.
17. Corinth Forum West 70-295; hatching shows orig core.
18. Argos C 8510, Daux 1967 fig 17; thn mauve & verm on bf.

19. Gonia FVIII (83,31).
20. Klenia; l b dp verm & mt bl on l b bf (81,24).
21. Argos C 8719; verm & thn ch on smth yel-cr.
22. Gonia aIII; rd & bl on bf; smth in.
23. " etaIV; v worn.
24. Klenia; rd & bl on crm-bf (88,1).
25. Gonia etaVI; dk gr core, pink bf skins; rd degraded to brn.
26. Argos C 8517, Daux 1967 fig 17; verm & mt ch on smth bf; cut out.
27. Klenia; lstrous or-brn & mt bl on yel-tan (87,6).
28. Corinth 1937, fig 33h; or & bl on l b bf.
29. " 1937; l lstr rd & mt bl on l b bf.
30. Gonia etaVI; rd & bl on b ivory out.

Fig.46

Polychrome.

1. Gonia; as 44,12.
2. " aIX;
3. " aVIII; thn dk purplish pnt; as 44,12.
4. Klenia; strky high b rd & mt bl on smth bf; as 44,16.
5. Gonia aV; as 44,3.
6. " Blegen 1930, pl.IIf.
7. " aVIII; outside of 3 (83,4).
8. " rd brn & mt bl on bf (83,17): inside.
9. " etaVIII; out, body.
10. " etaVIII; out, body.
11. " aVII; rd & thn bl on bf; in, as 44,20.
12. " aVIII; b rd & mt bl on bf; jar shoulder.
13. " etaV; jar belly (83,9).
14. " Blegen 1930, pl.IIj.
15. " etaVI; in, body.
16. " FVII; out, body, cf 83,13.
17. " eta V; body.
18. " Blegen 1930, pl.IIk.
19. " Blegen 1930, pl.IId.

20. *Gonia* Blegen 1930, pl.IIm (sketch).
21. " etaIII; b dk brn & mt bl on grn-crm, same out/in.
22. *Prosymna* fig 630,2.
23. " pl.III,5.
24. " fig.629.
25. " pl.III 1.
26. *Corinth Forum West* 70-228 (sketch).
27. " LWK 1948, pl.IVd.
28. " *Forum West* 70-561; (84,11), pedestal foot, "Bl on Rd ware."
29. " LWK 1948, pl.IIi.
30. " 1937; worn bl & or on b lt rd; inside of ped bwl.
31. " 1937; lstr rd & mt bl on bf; ped junction.
32. " 1937; thn or-rd & ch on bf; ladle frag as 41,24.
33. " LWK 1948, pl.IIe.
34. " *Forum West* 70-231; lstr rd & thn mt bl on bf; as 45,6.
35. " *Lechaion Road*; fn open bowl sherd.
36. " *Forum West* 70-533; or & ch on bf; pedestal (84,6).
37. *Klenia*; = 44,15.
38. " dp rd & mt bl on l b pink bf; as 44,17.
39. " as 44,9.
40. " body.
41. " b rd & mt bl on b crm-bf; closed body.
42. " b rd-brn & mt bl on b bf; out, open body (81,25).
43. " jar belly.
44. " jar belly.
45. *Alepotrypa*, *Papathanasopoulos* 1971b, pl.IV.
46. " mt mauve-bl w or-rd; jar shoulder (89,5).
47. *Franchthi*, unstrat; crusty verm & thn/mauve on l b bf; as 44,22.

Fig.47

Dot Incised; Prosymna Incised; Scratch Crusted.

1. Klenia; md fn rd; rough b, fn inc decor out (94,5).
2. " porous bl; bl b out in; fn inc out.
3. " dk porous; brn-bl smth slur.
4. " med fn rd; l b tan, shall inc (94,4).
5. " fn dk gr; glsy bl b out/in, fn wh fill inc.
6. " porous bl; bl b out/in.
7. Prosymna fig 633,1 (sketch).
8. Klenia; dk slur out/in (94,2).
9. " bl b out/in, fn inc (94,9).
10. Corinth 1959; smth rd; fn inc.
11. Klenia; smth rd-bf slur; part oblit inc.
12. " rd porous; dusky smthed; lines part oblit (94,7).
13. " crse dusky slur; lines part oblit.
14. Prosymna fig 633,6.
15. " fig 633,4.
16. " fig 633,7.
17. Corinth 68-49. (94,1).
18. " 40-534; convex bowl.
19. Klenia; rough dusky slur (94,8).
20. Corinth LWK; gr, shading to lt rd at base; shall sharp inc.
21. Lerna, Caskey 1958, pl.36a; wh crust preserved.
22. Corinth 1937, fig.29i; Zervos 374; glsy bl b out, bl b in.
23. Lerna, Caskey 1958, pl.58c;
24. Corinth 1937, fig.29k, glay bl b, fn scratch.
25. " 1959; bl b, fn scratch filled out.
26. " 1937; bl b, fn scratch out; rd-bf b in.
27. " 1959; bl b, fn scratch filled.
28. " 1937, fig.29j; Zervos 374; glsy bl b out; b tan in.
29. Gonia aV; l b dk, incised & dotted, wh filled out; wall above base.

30. Gonia eIV; crse gr bg; inc & dot; thk closed body (83,29).
31. " etaVI; dull bf slur; inc & dot; hndle; (83,26).
32. Akrata 967; smth bf; inc & impressed; 3 perf after firing;
complete (94,3).
33. Corinth P. of Apollo; pnk-bf fn; rd-brn pnt out/in; grve
& dot; overall b.
34. " P. of Apollo; hd crse bl; dk brn smthed, wh fill
inc out; rougher in.

Fig.48

Red Pattern Burnish

1. Klenia; bl & rd mott slp, pb.
2. Corinth, unstrat; warm bf; dk rd pb out; rd b in.
3. " unstrat; lt bf; rd-brn pb out.
4. " 1937; med fm bl; mt or slp out, dker pb; rd brn
pnt bnd in.
5. Klenia; lt rd; or-rd horiz stroke-b out; lt rd b in.
6. Corinth 1937, fig.29e; med fn dk; mahog pb out; gr in.
7. " (Lot)5243; crse hd; bf & rosy slp out & in rm; careless pb.
8. " 1959, Weinberg 1960, pl.63b 4; rd pb on mt or-rd.
9. " 1959, Weinberg 1960, pl.63b,1; rd pb on mt or rd.
10. Klenia; dk gr, bf skins; dp rd stroke-b, bl strks (93,6).
11. Corinth, unstrat; bl core, bf skins; rd-brn stroke-b.
12. " 1937.
13. Klenia; lt rd; rd pb out; smthed in.
14. " or-rd; rd stroke-b; fn lip bevel.
15. Prosymna fig.635,1 (not to scale).
16. Corinth 1959, Weinberg 1960, pl.63b,7; dp rd pb on strawberry
mt. as 21.
17. Klenia; rd; bl & dp rd mott, traces pb.
18. " rd; dk stroke-b (93,8).
19. Prosymna fig.635,9 (not to scale).
20. Klenia; dk, rd skins; strawberry stroke-b out, smth dull red in.

21. Corinth, unstratified; rd-brn pb.
22. Klenia; dp verm pb on dk rd.
23. Corinth unstrat; sft yel-bf; dp glsy rd pb.
24. Gonia; rd pb on mt strawberry.
25. Corinth, unstrat; dk rd pb on rd slp, out.
26. " 1937; cherry rd pb on strawberry ground.
27. Klenia; brn stroke-b on dusky rd out; traces b in.
28. Corinth 1959, Weinberg 1960, pl.65b,8; lt bf; rd brn strok b;
cut out.
29. Klenia; dp rd strokes on smth rd; cut out (93,7).
30. Corinth 1937; bf; rd-brn stroke-b.
31. Klenia; bl core, bf skins; sparse rd strokes out; dusky bf in.

Fig.49

Pattern Burnished, Period IV.

1. Klenia; fn gr; bl b strokes out; dk gr in.
2. " hd porous bl; strky high bl b out, less in (93,2).
3. " dk rd; horiz bl strokes on rm, vert mahog strokes
below; res lines ? pnt (91,6).
4. " crse rd; sparse bl & brn strokes out; angle approx.
5. " dusky dk brn, fn stroke-b.
6. " bl & mahog stroke-b out; smth bl in.
7. " hd porous bl; rd & bl mott stroke-b out (93,9).
8. Gonia etaV; strky b cherry rd slp, reduced to bl in parts.
9. " aIII; cherry rd stroke-b slp out/in.
10. " aII; brshed or-rd pnt & thn ch on yel-bf (83,3).
11. " aVIII; strky b cherry rd slp on bf, reserve decor (83,1).
12. " etaVIII; bl, to brn nr rm; overall stroke-b, reserve
decor.
13. " aVII; mt bl pnt on bright rd scribble b out/in.
14. " aVII; rd slp out; thn mt bl pnt on b rd slp in (81,1).
15. " aXI; rd-brn b line on smth warm bf.
16. " FVII; warm bf b, dk pb lines (worn) out.
17. " aVII; bl pnt on or-rd in; bright rd scribble b out (81,2)

Fig. 50 Period IV. -- Crusted Ware; White Painted

1. Nestor's Cave; high bl b out/in; thk relief pnt.
2. Klenia; dull rd; smth out/in. thk chalky crust out/in (95,8).
3. Franchthi, Jacobsen 1973b, fig 9,2; pl.52a; high b dk brn;
rd crust out w wh band; overall rd in.
4. Klenia; crse friable bf; pitted bf surface; traces chalk
crst out (95,7).
5. " smth dk gr out/in; traces rd out; rd & wh in (95,11).
6. " bl b out/in; thk dusty wh pnt out (95,12.13).
7. " bl b out/in; wh pnt traces in (95,4).
8. Franchthi, Jacobsen 1973b, fig 9,3; pl.52a; wh & rd decor.
9. Asea; fn bl b; traces pink crust out.
10. Franchthi, Jacobsen 1973b, fig 9,5; pinkish coating overall.
11. Klenia.
12. " dk porous; rough bl b out/in; wh crust out (95,5).
13. " smth rd-bf to dk; thk relief wh pnt out; smth tan
in (95,19).
14. " lt gr-bf; smth bf out, traces wh & rd; smth or-rd in
(95,3).
15. Akrata 972; gritty rd; dp opaque l b out, traces ghost pnt.
16. Lerna, Caskey 1959, pl.41,b; Zervos 338; rd brn; powdery
or (not to scale).
17. " Caskey 1958, pl.37a; rd; powdery or coating (not to
scale).
18. " Caskey 1959, pl.41d; Zervos 337; rd brn; wh crust,
rd pnt.

Fig. 51 Period IV, -- Early

1. Klenia; dense rd; smth out/in.
2. " fn grty rd; keeled lug.
3. " rd (101,8).
4. Corinth 1959; bl core; smthed rd out/in.
5. Alepotrypa; dense lt rd; dull bf-rd slur out/in.

6. Klenia; bl slur out/in (101,10).
7. Corinth 1937; smthed bf w rd to dk tinges.
8. " 1937; dk rd-brn mt out; rd b in.
9. Klenia; dk, bf skins; rd-bf b out; bf b in, dk lip.
10. " (101,12).
11. " dk tan to bl slur (101,7).
12. Corinth 1937; pink-gr; bf gr, traces dk b slp.
13. Klenia; crse lt rd; rough sooty bl out; smth in (101,6).
14. " crse dk; wh crust pnt (95,16; 101,9).
15. Argos C 8691; crse, large grts; dirty slur out; rough mott
slur in.
16. Klenia; dusky crm-bf; smth slur.
17. " crse dusky bf; dk rd brn b out; strky bl in.
18. Lerna; smth pink out/in.
19. Klenia; bl b, strong fluting (93,1).
20. " crse rd-bf-gr; dk rd & sooty bl slur out (101,11).
21. Corinth, unstrat; rd b.
22. Klenia (101,14).
23. Lerna, Caskey 1958, pl.37b; Zervos 336; dk gr-brn b (sketch).
24. Gonia; hd rd; rd ? slp.
25. Klenia; dk crse (101,13).
26. Corinth 1959; bf; worn sooty surface; width of hndle, .040.
27. Alepotrypa; dense crse rd; rd b out; less in.
28. Klenia; smth dk gr slur.
29. " crse; dusky rd slur out; smthed in.
30. Alepotrypa; crse or-rd; dk sooty surfaces (101,17).

Fig.52

"Period IV, Early

1. Akrata 1082; dk rd gritty; b dk rd-mahog-bl mott } slp.
2. Alepotrypa; crse lt rd, grog; dk b out/in (96,7)
3. Akrata 1027; crse gritty rd; b rd w bl mott out; smth in.
4. Phlius, Biers 1969, fig.3,34; 1 b rd-bf out/in.
5. " Biers 1969, fig.3,36; 1 b rd-bf out/in.

6. Phlius, Biers 1969, fig.3,37; crse dk rd; rough dk rd b out.
7. Alepotrypa; crse dull rd, grog; b bl & brn mott out/in;
fnt rippling.
8. " dk med crse; mott rd-brn bl b out; smth bl in.
9. " Hauptmann 1971, fig.54g; crse dk; dk b, fnt
rippling (96,8).

Fig.53

Period IV, Early.

1. Alepotrypa; dense fn bl; bl b out/in.
2. " dull rd; smth bf out/in.
3. Klenia; crse dk; bl b out/in.
4. " dusky crse; bl b out/in.
5. Alepotrypa; dense dk; dull bl b out/in.
6. Klenia; crse dk; bl b out/in.
7. Lerna, L 390; dk mahog & bl b out/in; low wide fluting.
8. Alepotrypa; dense bl; dk brn b out; bl b in.
9. " Hauptmann 1971, fig.54f; crse dk, grog; mott
bl b out/in; low fluting on shoulder (96,6).

Fig.54

Period IV, Early/Late; Plain Ware.

1. Alepotrypa; dense dk; dk b out/in.
2. " rough b or-rd out; smth lt bf in.
3. " rough rd b slp out/in.
4. Argos C 8588; bl, rdish patches out; rd, bl patches in.
5. Akrata 966; crse rd-bf-dk; smth rd bf, bl patches out; rest
hndle.
6. Alepotrypa; bl, fn grts; b dk rd-brn to bl slp out.
7. Argos C 6681; hd bl & gr; bl & tan mott b out; l b strky bf in.
8. Klenia; crse lt rd; rd brn smth slur.
9. Alepotrypa; med fn dk porous; fn wiped slur out/in.
10. Klenia; hd porous dk brn; smth brn out; boriz strk b in.
11. Alepotrypa; dense brn; smth dk sooty brn out/in; well made.
12. Klenia; crse lt rd-br-gr; dk rd & sooty bl.
13. " gr core, bf skins, med crse; dusky slur out (100,8)

14. Ayioryitika; bl porous; dk to rd-bf mott slur out; dk tan in.
 15. Alepotrypa; hd rd; roughly made; smth bl-gr-mahog mott out/in
 (97,1).
 16. " or rd; smth in & upper out; earth imprint under.
 17. Asea fig.38c; smth bl mt out/in, paler mott (97,2).

Fig.55

Period IV, Early/Late; Plain Ware.

1. Alepotrypa; rd b out & in lip.
2. " l rd-brn b out.
3. " l rd-brn b out; rough in.
4. " fn dense gr; smth warm bf out/in.
5. Klenia; med crse lt rd; rd slur out/in.
6. Alepotrypa; crse dk; smth rd out, sooty patches.
7. " off-white fabric, surfaces worn.
8. Klenia; or-rd slur out/in.
9. Alepotrypa; crse hd lt rd; dull rd-bf to dusky slur; rough
flaking in.
10. " fn bl porous, red skins; rd slur out; dk tooled
in (98,2).
11. " hd porous dk rd; dk b out; smthed in.
12. Klenia; crse dk; dusky slur out; bl b in.
13. " crse dk rd; rough dusky slur out/in.
14. Alepotrypa; fn dk; dk b out/in.
15. " med crse rd; smth dusky rd out/in.
16. " lt rd; rd brn mott b out; smth dull in (101,23).
17. " hd rd; smth dk out; dk rd in.
18. Klenia; crse; dusky rd slur out/in.
19. Alepotrypa; hd bl, rd skin out; dk in (101,21).
20. " warm bf; bf slur out/in (101,22).
21. " dense dk rd; brn b out.
22. Klenia; hd crse dk gr; rough bl out/in.
23. Alepotrypa; or, wh grts; surfaces encrusted.

24. Alepotrypa; dk, rd patches; dk b out/in; smth under.
 25. " dense dk rd; good tan b out/in (101,24).
 26. Klenia; v crse friable dk rd; slur out/in.

Fig. 56 Period IV, Early/Late; Plain Ware.

1. Alepotrypa; bf; l b dk rd to bl slp out/in.
 2. " rd-brn b out/in.
 3. Klenia; med fn bf; high bl b out/in.
 4. Alepotrypa; dense bl; bl b out/in.
 5. " rd-bf; l b rd slp out/in.
 6. " dk dense; bl b in; outside encrusted.
 7. " dk; smth mahog out/in (97,4).
 8. " dk dense; dk b out/in (96,2).
 9. Klenia; dk med crse; bl & dk mahog b out/in.
 10. Alepotrypa; hd crse gr; l b dk out/in (96,11; more open angle).
 11. Klenia; fn porous rd; dk brn b out/in; vert stroke-b in
 below rn.
 12. " dk crse; bl b slp out/in.
 13. " dk crse; bl b slp out/in.
 14. Alepotrypa; or rd; dusky bf out; dull rd in (97,5).
 15. Corinth P. of Apollo; dense bl; b striated tan; fn inc, rd
 fill; hndle/lug root, c. .060m wide.
 16. Alepotrypa; crse dk rd; rosy-bf b out; worn in(98,1).
 17. " dense bl; bl b out/in.
 18. " lt rd; smth dull lt rd out/in (97,3).

Fig. 57 Period IV, Late.

1. Alepotrypa; crse dk rd; smth slur out/in; perf rn, plastic.
 2. " gr, rd skins; dull mt rd out/in; perf rn, plastic.
 3. " crse rd; dk rd slur (99,5).
 4. " crse rd; smth rd-bf; perf rn (98,4).

Fig. 58 Period IV, Late.

1. Alepotrypa; dense lt brn; rough dusky slur.
 2. " rd, large crse grts, grog; smth out & in neck.

3. Alepotrypa.
4. " crse or-rd; dk dusky slur (101,2).
5. " rd; dk mahog upper out, lter below; bl patches;
4 handles.

Fig. 59

Period IV, Late.

1. Alepotrypa; dense rd; slur out; smthed in (99,3).
2. Klenia; gr core, rd skins; dull rd slur out; dker in (100,10).
3. Alepotrypa; 1 b dk upper, rd lower, out.
4. " lt rd; smth slur.
5. " or-rd; smth lt rd slur.
6. " lt brn; 1 b dull rd out.
7. " hd dk; dk b out/in.
8. Argos; med crse; rd & bf smthed; fire blackened below.

Fig. 60

Period IV, Late.

1. Alepotrypa; dk; b crazed dk mahog ?slp out; smth dk gr in.
2. " crse or rd; slur out/in (101,16).
3. " crse or rd.
4. " crse or rd; dk dusky surfaces (99,2).
5. " hd dk rd; dusky out/in.
6. " crse b (96,10).
7. Asea fig 82 d; crse or to dusky, grog; dusky & rd mt slur.
8. Klenia; crse dusky rd; lt rd slur.
9. Alepotrypa; crse bf; dk slur out; dk smth in (96,9).
10. " crse rd; dker slur (99,1).
11. " crse or rd; dull brn slur (101,5).
12. " rd, wh grts; crse dker slur out (101,4).
13. " pithos wall.
14. " pithos wall.
15. " coarse rd, smthed; two lugs preserved.

Fig. 61

Period IV, Early/Late; Period III, Rhyta.

- 1.2.5.6.9.10. from Klenia.

3.4.7.11 from Alepotrypa.

8. from Asea.

12. from Gonia.

13. Corinth LWK; dense gr; quartz, chert, bl grts & grog; bl, large tan patches; fn incised, worn. h. of leg, front. .109m.

14. Corinth Forum West 70-155; dense hd bf, thk bl skin inside below; high b bf to rosy bf out; bl pared in.

15. Corinth P. of Apollo; fn dense lt gr; smth gr, incised.

16. Corinth.

17. " MF 3447.

18. Alepotrypa; dense dk gr, bl b, fn incised (102,3).

19. " hd bl, med grts; bl b out, shall grves; rough b in.

Fig.62

Map of Period I sites; list on p.70.

Fig.63

Map of Period II sites; list on p.121.

Fig.64

Map of Period III sites; list on p.186

Fig.65

Map of Period IV sites; list on p.297

Fig.66

Period I; Nemea.

1 - 38 Nemea.

1. = 6,6.

9. reduced; body.

2. = 2,5.

10. reduced; body.

3. as 2,4.

11. body; knob scar (cf 66,33)

4. = 10,6; as 4,15.

12. body.

5. wh slp; 10,14; jar shoulder.

13. = 5,4.

6. body.

14. = 7,1.

7. body.

15. as 6,10.

8. rare bl pnt, nr firnis.

16. body.

- | | |
|-------------------------------|-----------------------------------|
| 17. body. | 28. = 10,11. |
| 18. body. | 29. = 4,3. |
| 19. = 10,27. | 30. = 10,16. |
| 20. = 10,4; as 4,10. | 31. dp rd slp; 3 pellets; as 2,4. |
| 21. = 10,3. | 32. as 9,30. |
| 22. as 6,7. | 33. as 1,11. |
| 23. = 2,6. | 34. bf spgy; h-p lug. |
| 24. = 4,22. | 35. bl spgy; as 9,31. |
| 25. typical variegated; Late. | 36. = 8,26. |
| 26. oblique pellet; cf 10,16. | 37. = 9,11. |
| 27. body. | 38. knob as 1,11. |

Fig.67Period I.

- | | |
|----------------------------------|-------------------------------|
| 0. Akrata; = 10,20. | 9. Nemea; = 8,16. |
| 1. " = 10,19. | 10. " = 8,3. |
| 2. " = 10,18. | 10a. " = 8,11. |
| 3. " = 7,6. | 11. " = 8,19. |
| 4. " = 10,29. | 12. " sim 8,17. |
| 5. " cf 10,21;
? askos belly. | 13. " rd slp; askos hndle. |
| 6. " = 10,22. | 14. " = 8,8. |
| 7. " = 10,21. | 15. Ayioryitika; = 2,4. |
| 8. " . | 16. " thn wh slp, as
4,15. |
| | 17. " = 4,19. |

Fig.68Period I.

- | | |
|--|--------------------|
| 1. Asea; = 2,16. | 6. Nemea; as 8,20. |
| 2. " = 2,15. | 7. " as 8,24. |
| 3. Akrata; fn bf; rd brn brshd
slp all over & in
(p.90). | 8. " = 8,15. |
| 4. Nemea; = 8,20. | 9. " = 8,10. |
| 5. " = 8,21. | 10. " = 8,2. |
| | 11. " . |

Fig.69

Period II.

1-28 from Corinth LWK illustrate the range of colours and firnis slips of the best Corinthian Urfirnis.

1. = 23,29.

21. = 23,22.

23. = 11,1.

25. = 13,4; basically Period I fabric and paint, but is not EN; very early II.

29-44 from Ayioryitika; note absence of light buff ground colour.

29. sim 13,1.

30. = 23,33; as 11,7, in.

31. = 18,10.

32. = 13,1.

34. sim 18,3.

35. inside open bowl.

36. sim 21,6.

41. inside 29.

44. = 23,65.

Fig.70

Period II, Urfirnis:

1. Ayioryitika; = 17,2.

6. Asea fig 49,a.

2. Asea; = 17,4.

7. Asea; = 17,7.

3. Ayioryitika; = 17,1.

8. Ayioryitika; = 21,13.

4. Asea; = 21,14.

9. Asea fig 56; as 21,6 but vertical.

5. Asea fig 50,b; as 17,5.

10. Asea fig.50a.

Fig.71

Period II.

1. Koufovouno; typ stroke firnis.

3. Akrata; = 23,44.

2. Akrata; = 12,1.

4. " = 16,4.

Fig.72

Period II:

1. Akrata; = 15,10.

4. Akrata; = 11,8; 24,4.

2. " = 15,7.

5. " = 15,9.

3. Koufovouno; = 22,23.

Fig.73

Period II.

- | | |
|-------------------------|--------------------------|
| 1. Ayioryitika; = 17,5. | 4. Ayioryitika; = 13,10. |
| 2. " = 17,6. | 5. " = 12,6. |
| 3. " = 18,3. | 6. Asea; = 15,8. |

Fig.74

Period II.

- 1-12 Corinth LWK inside.
 13-24 Corinth LWK outside.
 12 & 24; cut out pedestal frag.
 22. = 13,4.
 25. Corinth; = 21,11.

Fig.75

Period II.

- 1-31 Ayioryitika rim sherds showing different painted motifs.
- | | |
|------------------------|----------------|
| 1. = 23,33; as 11,7. | 11. cf 13,9. |
| 13. as 12,10. | 14. = 23,31. |
| 15. sim 14,16. | 19. sim 14,16. |
| 21. = 23,55; as 12,10. | 30. as 12,10. |

Fig.76

Period I & II.

- 1-13 Ayioryitika.
- | | |
|---|----------------|
| 1. sim 20,12. | 7. as 22,13. |
| 2. = 22,6. | 8. = 23,17. |
| 3. sft lt pink bf; rd pnt, rd
strky overslop; as 13,2. | 9. = 10,34. |
| 4. = 20,18. | 10. = 2,14. |
| 5. carination as on 17,7. | 11. = 21,20. |
| 6. 21,16. | 12. = 22,13. |
| | 13. sim 22,23. |

Fig.77

Period II.

- 1-23 Koufovouno; motifs and stroke-firnis sherds.

- | | |
|--------------|-------------------|
| 1. as 15,10. | 6. = 11,15. |
| 2. as 20,9. | 7. rm as on 13,9. |
| 3. as 11,3. | 8. rm as 13,7. |
| 4. as 14,9. | 9. as 20,3. |

- | | |
|---------------|------------------------|
| 10. = 12,4. | 20. sim 11,14; larger. |
| 11. = 20,1. | 21. as 12,10; larger. |
| 19. as 12,10. | 22. rm as 13,6. |

Fig.78

Period II.

1. Asea fig.111,8; pl.1Ik; made on a core; fn bf; bl pnt on warm bf; thn overslip overall including inner (medial) surface; sharp incised triangle; h. .052m (1:1).
2. Asea fig 111,9; bl on warm bf; no overslip; medial surface carefully smthed before firing; buttock & foot broken; h .073m (slightly smaller).
3. Asea fig 111,7; rd firnis pnt on bf (1:1).
4. Ayioryitika; = 21,7.
5. " = 23,65.
6. " = 14,16.

Fig.79

Period III .

1. Akrata 992; fn lt rd; traces thn slp & lustr bl pnt on head & neck; double eye incisions; h .047m. (ca 3:2).
2. Akrata 1020; v fn marble or calcite; broken at neck; h .055m. (slightly larger).
3. Akrata 985; clay as 1; pnt & thn transparent slp as 1; traces slp on medial surface; pubic triangle incised after separation from other leg or matrix; h .083m. (ca 1:1).
4. Akrata 1021; fn lt pink bf; smth lt crm-bf; lustr ch to brn pnt stripes; traces of b on medial surface; incised pubic triangle; h .068m. (1:1).

Fig.80

Period III; Black or Red.

All from Corinth.

- | | |
|----------------------|---------------------|
| 1. = 36,1. | 3. = 36,7. |
| 2. 70-535; as 36,10. | 4. 70-537; as 36,7. |

Fig. 81

Period III, Gonia Red Slip; Matt-Painted

- | | |
|---|--|
| 1. Gonia; = 49,14. | 16. Klenia; thn ch pnt; body. |
| 2. " = 49,17. | 17. " = 41,20. |
| 3. " aVIII; bl mt ov
brshd slp, in. | 18. " = 41,12. |
| 4. " thk mt verm on
rd-brn b. | 19. " = 43,38. |
| 5. " thn mt rd on wh slp;
body. | 20. " body. |
| 6. " as 4; rm as 45,14
(inverted). | 21. " body. |
| 7. Corinth 1937. | 22. " lstr verm pnt; body. |
| 8. " 1937. | 23. " = 45,9. |
| 9. " 1937. | 24. " = 45,20. |
| 10. " 1937. | 25. " = 46,42; 87,5. |
| 11. " 1937. | 26. " prob same as 24. |
| 12. " 1937; ped foot as
37,28. | 27. " or pnt zigzag; body. |
| 13. Klenia; = 42,2. | 28. " thn ch pnt on tan,
overall b; as 37,30. |
| 14. " mt ch on grn-crm;
as 36,9. | 29. " dk verm mr pnt; body. |
| 15. " dp rd pnt out; bl
in; as 36,5. | |

Fig. 82

Matt Painted.

All from Alepotrypa. Figures from Hauptmann 1971.

- | | |
|----------------------|--|
| 1. fig.47 e. | 8. = 45,11. |
| 2. = 41,13; fig.48b. | 9. wh slp; shoulder. |
| 3. fig 48d. | 10. mt bl on mt dk slp; as 42,3. |
| 4. shoulder. | 11. bl on rd; shoulder. |
| 5. = 42,11; fig.47c. | 12. = 43,33. |
| 6. = 41,18; fig.47a. | 13. bl on tan; shoulder (pho
too dk). |
| 7. = 42,8. | |

Fig.83

Matt Painted. Polychrome.

All from Gonia.

- | | |
|------------------------------------|--|
| 1. = 49,11. | 16. body. |
| 2. rim. | 17. = 46,8. |
| 3. = 49,10. | 18. wh slp; body. |
| 4. aVIII; = 46,3 out;
as 44,11. | 19. body. |
| 5. aVII; in; as 40,22. | 20. etaVI; body. |
| 6. FVII; in; body. | 21. FVII; = 45,19. |
| 7. etaVIII; in; body. | 22. = 44,19. |
| 8. wh slp; body. | 23. = 44,7. |
| 9. = 46,13. | 24. aV; fn scratch out; oblique
pnt lines out/in; as 44,13. |
| 10. rd & thn mauve on bf;
body. | 25. body. |
| 11. = 44,20. | 26. = 47,31. |
| 12. = 44,21. | 27. aIX; thk wall; wh slp; same
out/in. |
| 13. = 44,12. | 28. body, in. |
| 14. = 45,14. | 29. = 47,30. |
| 15. aVI; out; body. | |

Fig.84

Matt Painted.

All from the Corinth Forum West excavations.

- | | |
|-------------------------------|--|
| 1. 70-541; underside of base. | 7. 70-552; jar rim. |
| 2. 70-542; pedestal bowl rim. | 8. 70-551; sim 39,17; lip pnt
as 38,12. |
| 3. 70-530; = 43,23. | 9. 70-553; sim 40,24. |
| 4. 70-531; = 43,47. | 10. 70-550; bl on rd in; wh slp
out. |
| 5. 70-532. | 11. 70-561; = 46,28. |
| 6. 70-533; = 46,36. | 12. 70-224; = 38,8. |

Fig.85

Matt Painted.

All from the Corinth Forum West excavations.

- | | |
|---|---|
| 1. 70-544; as 38,32. | 10. 70-555; = 43,62. |
| 2. 70-545; as 38,32. | 11. 70-554; body. |
| 3. 70-546; as 38,32. | 12. 70-539; large; crse; dk
pnt; body. |
| 4. 70-543; as 38,32. | |
| 5. 70-557; = 41,3. | 13. 70-549; = 43,12. |
| 6. 70-560; = 43,2. | 14. = 43,13. |
| 7. 70-558; 38,31. | 15. 70-534; mt ch on b crm; rm
as 41,10. |
| 8. 70-556; mauve on crm in;
simple lip band &
grve out; as 39,20. | 16. 70-548; = 43,28. |
| 9. 70-559; as 38,25. | 17. 70-538; = 43,54. |
| | 18. 70-536; mt bl on crm slp;
as 41,3. |

Fig.86

Matt Painted.

All from the Corinth Forum West excavations.

- | | |
|---------------------|--------------------------------------|
| 1. 70-299; = 38,32. | 4. 70-289; = 40,4. |
| 2. 70-218; = 39,22. | 5. 70-297; lt crm; bl crazed
pnt. |
| 3. 70-224; = 38,8. | 6. 70-289; = 40,4. |

Fig.87

Matt Painted; Polychrome.

All are from Klenia except 1.

- | | |
|--------------------------------|---------------------------|
| 1. Corinth 70-94; = 44,6. | 7. body. |
| 2. = 40,6. | 8. lstr bl on 1 b grn gr. |
| 3. = 53,8. | 9. = 43,44. |
| 4. b bl on b or-brn; as 41,11. | 10. = 43,44. |
| 5. = 46,42; 81,25. | 11. base as 41,25. |
| 6. = 45,27. | 12. = 43,56. |

Fig.88

Matt Painted; Polychrome.

All from Klenia.

- | | |
|-------------|--------------|
| 1. = 45,24. | 4. = 43,27. |
| 2. = 44,15. | 5. jar neck. |
| 3. = 37,19. | 6. = 42,9. |

Fig.89

Matt Painted

All from Alepotrypa.

- | | |
|--|---------------|
| 1. = 43,25. | 5. = 46,46. |
| 2. = 42,6. | 6. = 42,13. |
| 3. ch on strky wh slp; as
42,15. | 7. sim 42,13. |
| 4. dk ch on bf; collar as
42,11; hndle. | |

Fig.90

Grey Ware, Period III.

1. from Alepotrypa; 2-6 from Corinth 1937; 7-15 from Corinth LWK.

- | | |
|--------------|----------------------|
| 1. = 29,12. | 9. = 33,3. |
| 3. as 32,12. | 11. as 32,23. |
| 6. as 26,19. | 12. as 33,14, belly. |
| 8. = 32,30. | |

Fig.91

Grey Ware, Period III.

All from Klenia

- | | |
|----------------------------|--|
| 1. = 31,22. | 6. = 49,3. |
| 2. lt gr; as 33,14, belly. | 7. gr; handle on bowl as 33,14. |
| 3. = 33,2. | 8. = 32,11. |
| 4. = 32,3. | 9. lt grn-gr; strap hndle; as
25,4. |
| 5. = 30,26. | 10. = 33,6. |

Fig.92

Black Ware Grey on Grey, Period III.

All from Corinth.

1. 70-562; from a mixed context with Forum West and later material;
bl; bl b; part of shallow bowl or ladle with handle
rising from rim; ware and finish do not look EN (p.209).
2. = 29,4.
4. 70-273; bl b, wh ghost pnt; as 29,11.
5. = 28,5.
6. 70-473; Grey on Grey; sim 35,27, rim.

Fig.93 Stroke-burnish; Fluted; Early IV.

All from Klenia.

- | | |
|---------------------------------|-------------|
| 1. = 51,19. | 6. = 48,10. |
| 2. = 49,2. | 7. = 48,29. |
| 3. as 27,16. | 8. = 48,18. |
| 4. = 27,16. | 9. = 49,7. |
| 5. bl stroke burnish; as 47,11. | |

Fig.94 Prosymna Incised; Odd Incised; Period IV.

- | | |
|---|--------------------|
| 1. Corinth 68-49; 1940 excavation,
New Museum extension. | 5. Klenia; = 47,1. |
| 2. Klenia; = 47,82. | 6. " = 47,9. |
| 3. Akrata; = 47,32. | 7. " = 47,12. |
| 4. Klenia; = 47,4. | 8. " = 47,19. |
| | 9. " = 47,9. |

Fig.95 Crusted Ware; Painted Grey.

All from Klenia.

- | | |
|--|--|
| 1. wh & rd on smth gr-tan out;
lt rd in; body & hndle,
as 50,11. | 10. as 50,2.4. |
| 2. wh crust; body. | 11. = 50,5. |
| 3. = 50,14; base. | 12. = 50,6. |
| 4. = 50,7. | 13. = 50,6. |
| 5. = 50,12. | 14. = 35,25. |
| 6. wh crust; body. | 15. = 35,24. |
| 7. = 50,4. | 16. wh crust; vert tube lug;
= 51,14. |
| 8. = 50,2. | 17. wh crust; plastic decor. |
| 9. as 50,4. | 18. wh crust; long strap hndle. |
| | 19. = 50,13. |

Fig.96 Early & Late IV Monochrome.

All from Alepotrypa.

1. = 56,16.
2. = 56,8.
3. open bowl rm.

- | | |
|------------------|--------------|
| 4. open bowl rm. | 8. = 52,9. |
| 5. open bowl rm. | 9. = 60,9. |
| 5. = 53,9. | 10. = 60,6. |
| 7. = 52,2. | 11. = 56,10. |

Fig.97.

Late IV Monochrome.

- | | |
|-------------------------|--------------------------------|
| 1. Alepotrypa; = 54,15. | 4. = 56,7. Alepotrypa; = 56,7. |
| 2. Asea; = 54,17. | 5. = 56,14. " = 56,14. |
| 3. Alepotrypa; = 56,18. | |

Fig.98

Late IV.

All from Alepotrypa.

- | | |
|----------------------|-------------------------|
| 1. Wide-mouthed jar. | 3. complete collar jar. |
| 2. = 55,10. | 4. = 57,4. |

Fig.99

Late IV Pithos Decoration.

All from Alepotrypa.

- | | |
|--------------------------------------|----------|
| 1. = 60,10. | 7. body. |
| 2. = 60,4. | 8. " |
| 3. = 59,1. | 9. " |
| 4. as 57,1. | 10. " |
| 5. = 57,3. | 11. " |
| 6. = 61,11; body & hndle as
60,9. | 12. " |

Fig.100

Late IV.

- | | |
|------------------|-----------------------------|
| 1. Klenia; body. | 6. Ayioryitika; pithos rim. |
| 2. " pithos rim. | 7. Klenia; as 59,2. |
| 3. " body. | 8. " = 54,13. |
| 4. Ayioryitika. | 9. " body. |
| 5. " . | 10. " = 59,2. |

Fig.101

Early & Late IV.

1-5 from Alepotrypa; 6-15 from Klenia; 16-25 from Alepotrypa.

1. body; hndle as 60,9 but
narrower.

2. = 58,4.

- | | |
|-----------------------------|--|
| 3. tube handle on bowl rim. | 14. = 51,22. |
| 4. = 60,12. | 15. knob; rm as 51,11. |
| 5. = 60,11. | 16. = 60,2. |
| 6. = 51,13. | 17. or-rd; dk dusky surface; body. |
| 7. = 51,11. | 18. = 37,24. |
| 8. = 51,3. | 19. dk gr; broken & ground ped from below. |
| 9. = 51,14; 95,16. | 20. = 25,25. |
| 10. = 51,6. | 21. = 55,19. |
| 11. = 51,20. | 22. = 55,20. |
| 12. = 51,10. | 23. = 55,16. |
| 13. = 51,25. | 24. = 55,25. |
| | 25. as 55,19. |

Fig.102Rhyta; Period IV Figurines.

1. Alepotrypa (Hauptmann 1971, fig.526); fn grained marble; broken at waist; h. .065m; head identical to a painted & incised clay head from Franchthi (Jacobsen 1973b, pl.52d.e).
2. Alepotrypa (Hauptmann 1971, fig.52a); fn grained marble; broken at neck; h. .087m; sim torso from Athens Acropolis (Hesperia 8, 1939, 406; fig.88).
3. Alepotrypa; = 61,18.
4. Asea fig 111,1; hd med fh bl, wh grts; thn dull rd skins; well b warm tan; broken neck & waist; arms bent at elbow; shoulder width .070m (1:1).

Fig.103Alepotrypa Metal.

1. Sparta Museum 5610. L. .148; W. butt .006, centre .011, blade .009; max Th. .0105m. Top, bottom and sides flat, corners square. Rounded butt slightly jagged, and swollen from percussion or haft-squeeze. Blade with ground bevel, rounded and slightly battered. The whole tool is curved downwards and sideways, probably

from use. A patch of pale green corrosion on one side (v.photo) bears faint impressions as from a bone or antler sleeve. The cut on the top is modern.

2. 5611. L. .078; W. butt .018, blade 1037; max Th. .011m.
Convex top, flat bottom and sides; corners square. The butt has rough-cast pitting and a casting depression, and shows no signs of percussion or squeeze. The blade is sharp, but burred at the corners.
3. 5612. L. .061; W. butt .017, blade .010; max Th. .009m. Top slightly convex, bottom slightly hollow near the blade, sides flat; corners square. Butt slightly oblique, with porous granular surface and burred edges; probably broken and reused. Blade sharp, straight and slightly battered.
4. d. .040; av. Th. .003; expanded end d. .005m. Another similar, broken, with small casting protuberance, still rough, near break.
5. d. .055; av. th. .004; expanded ends d. .007m. Surface shows gold coloured streaks at one place, and there are shakes on one side as from cold bending or hammering. Another similar, restored.
6. Small beads d. ca .003m, apparently cut as segments from a continuous, seamless tube with max wall Th. .00025. Central bead d. ca .0065, W. .003m (photo slightly larger than 1:1).
7. Oval bead: L. .011; max d. .0075; end d. .005m. Made from thin sheet silver. Pendant: max L. .024; max Th. .0025. One face slightly convex; the other, flat. The holes have been drilled and reamed (ca 2:1).

The set of silver jewellery is illustrated in Hauptmann 1971, fig.53.

The metal from Alepotrypa has been briefly discussed above (p.52). The copper tools, along with the two Sesklo axes, were, with the permission of Professor Marinatos, drilled in 1970 by Professor Henrickson for a trace element analysis by neutron activation at the Democritos establishment, and it is hoped to treat them more fully in a short article. The jewellery and tools, with other more recent metal finds by Papathanasopoulos (AD 17, 1961-2, pl.67; Lambert 1972, 860) make Alepotrypa the richest site in Greece for metal artifacts of this period. It has been suggested above that this period is not later than the transition from Final Neolithic to EH I, and contemporary with the earliest Grotta-Pelos phase. This is my conclusion from a study of the pottery which was available before 1971, when Papathanasopoulos made the first archaeological excavations in the cave. The typological evidence of the metal artifacts themselves cannot be strong because so little pre-EH II metalwork is known in the Aegean. The adze is unique in this region; there is one almost identical from the Grotta Tominz at San Canziano, near Trieste, not well dated and geographically remote. Copper tools from ^{possibly} Neolithic contexts in Albania, including a "hache-burin" indicate that metal was ^{perhaps} in use at this time along the southern Adriatic coast (Bull. d'Arch. S.-E.Eur.2, 1972, 13), and axes typologically close to late stone celts are known from a few neolithic sites in Greece and Crete (Pevkakia, perhaps Sesklo, Knossos); one in the BSA "from Spata" is an exact replica of a common type of celt. The chisels have parallels in EB I Aegean contexts (Troy I; Poliochni) as well as later ones. The pendant has close parallels, in other materials and in metal, at Eileithya, Kitsos, Pevkakia and Sesklo. Further afield it is a common type in the East Aegean, the Balkans and Central Europe, and is found as far north as West Gotland, at different periods.

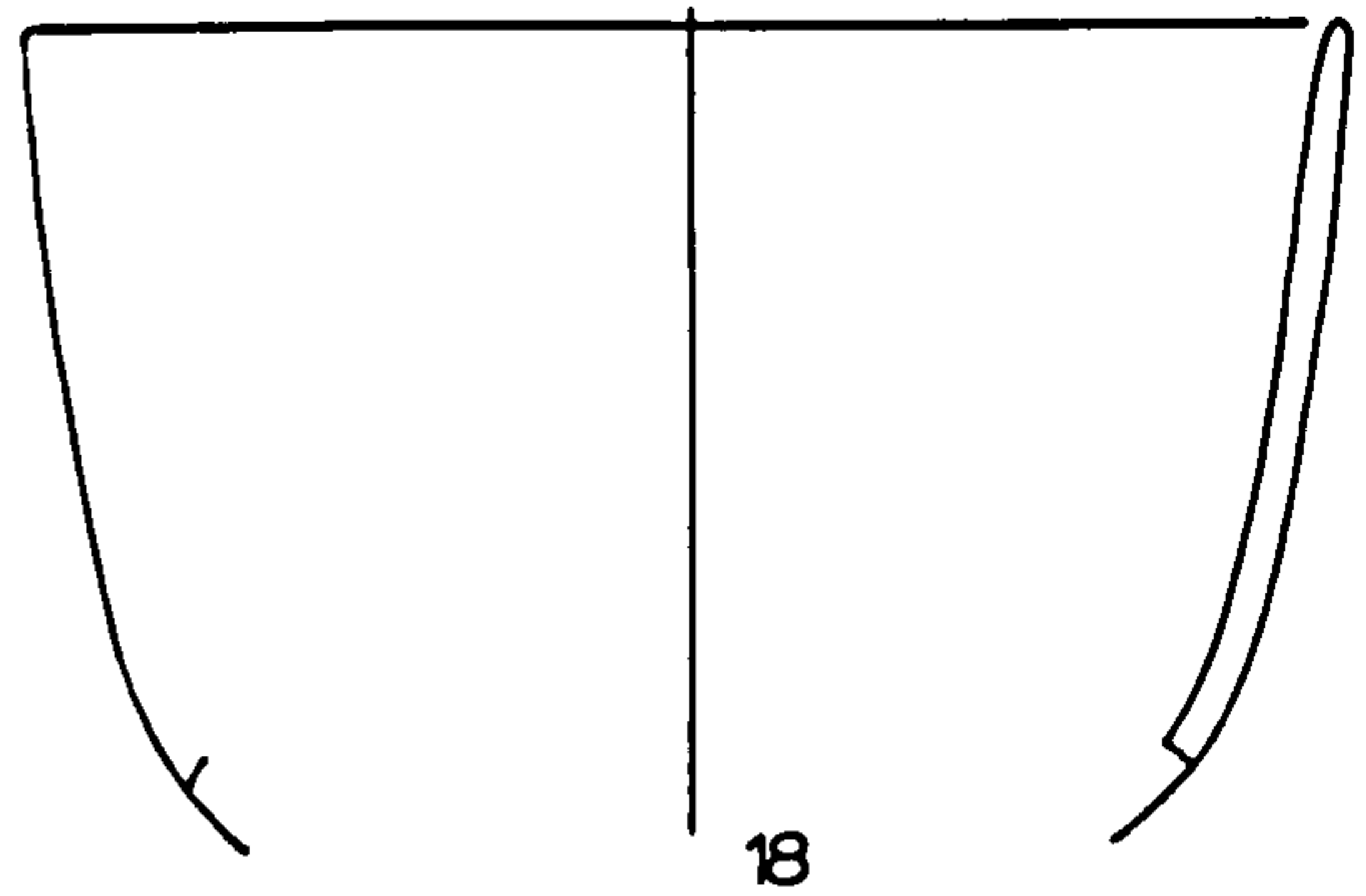
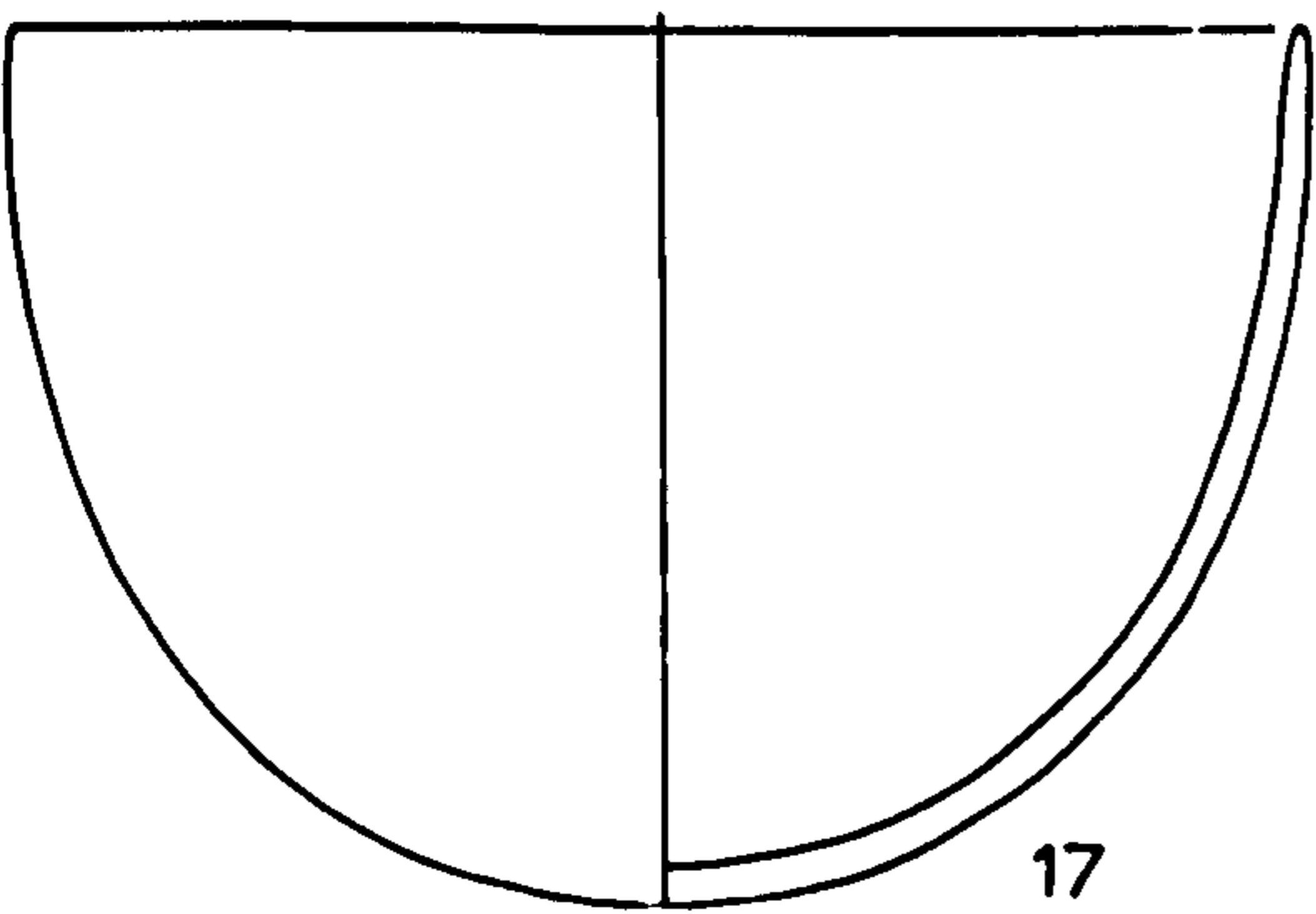
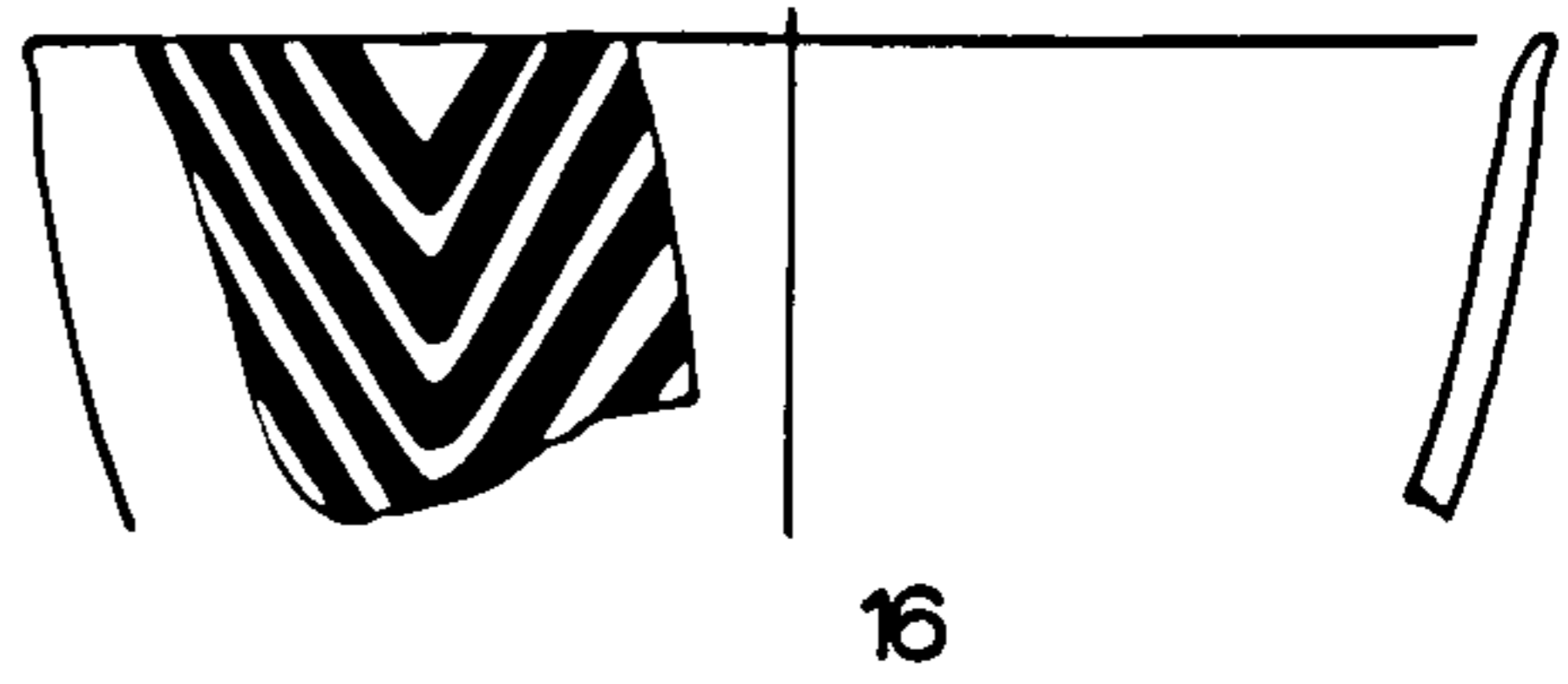
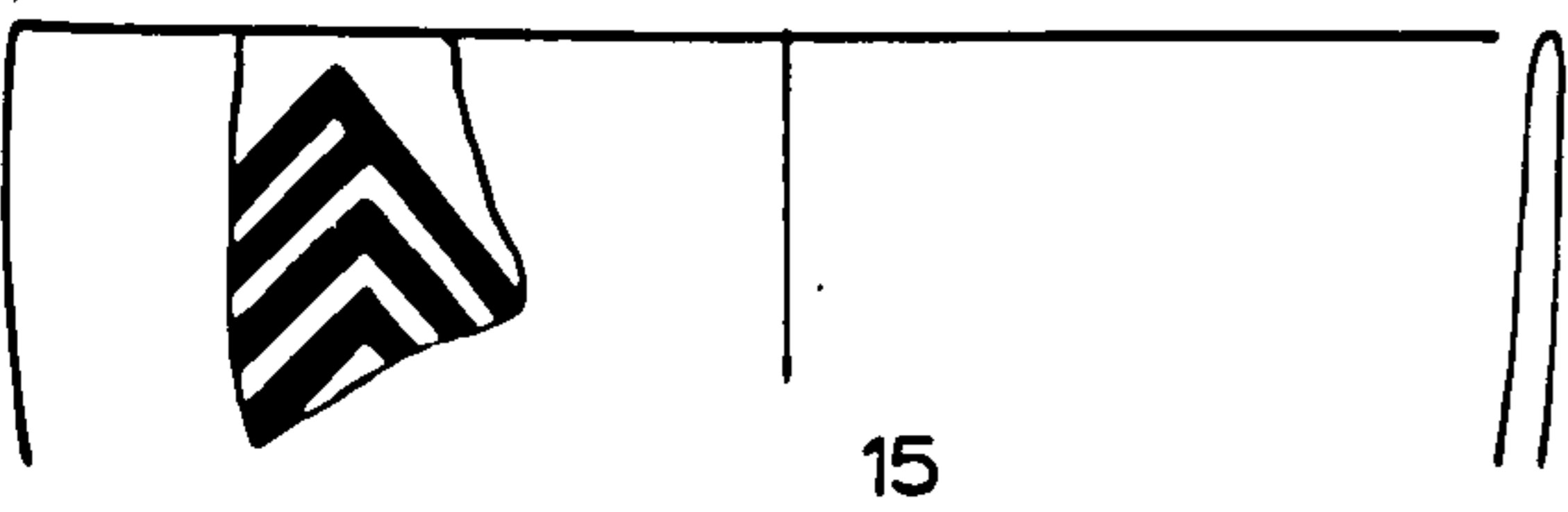
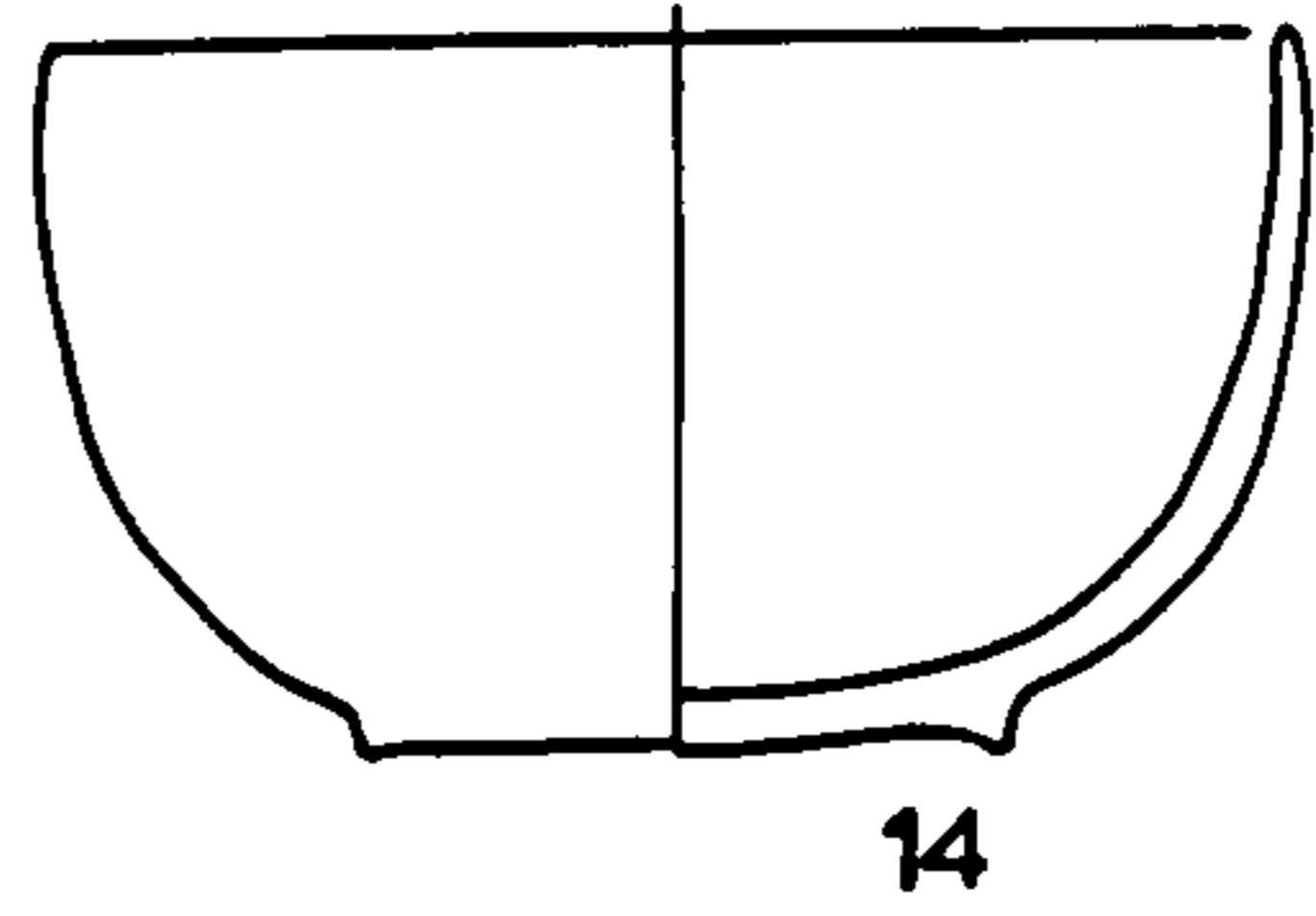
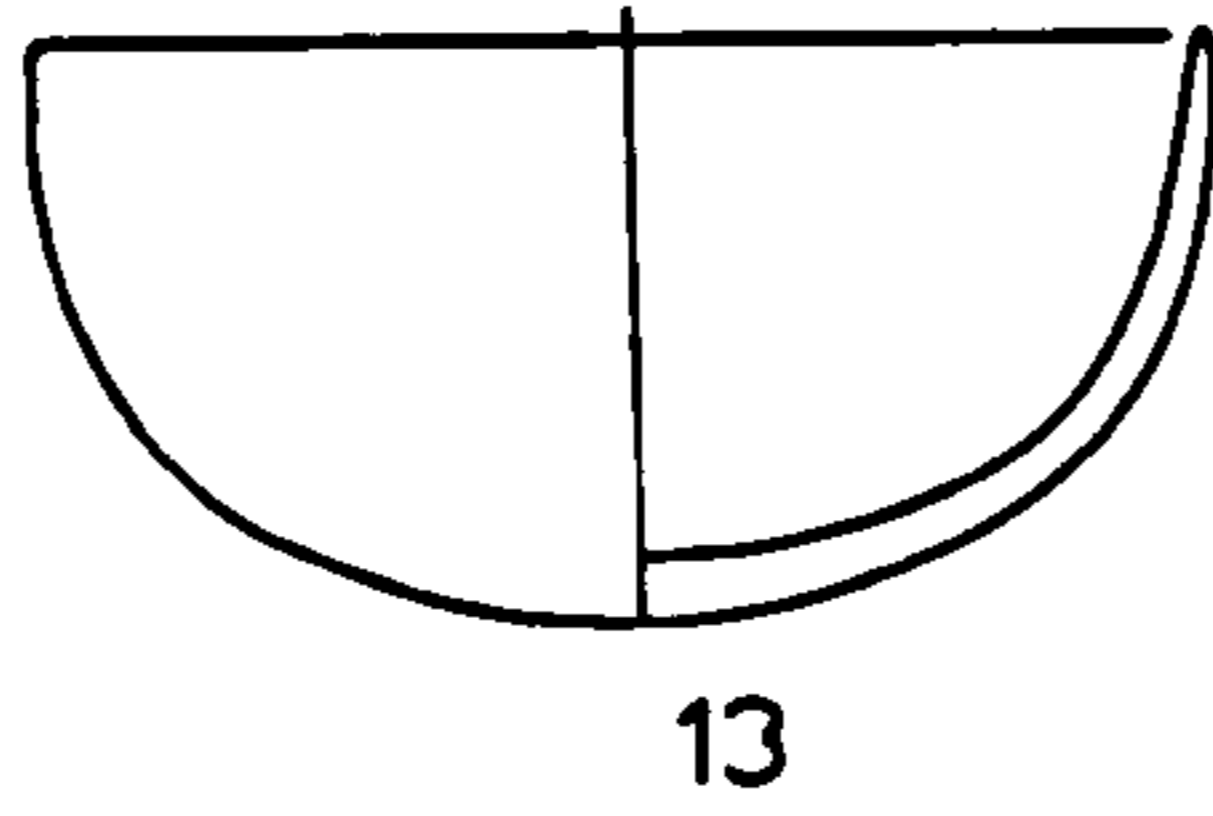
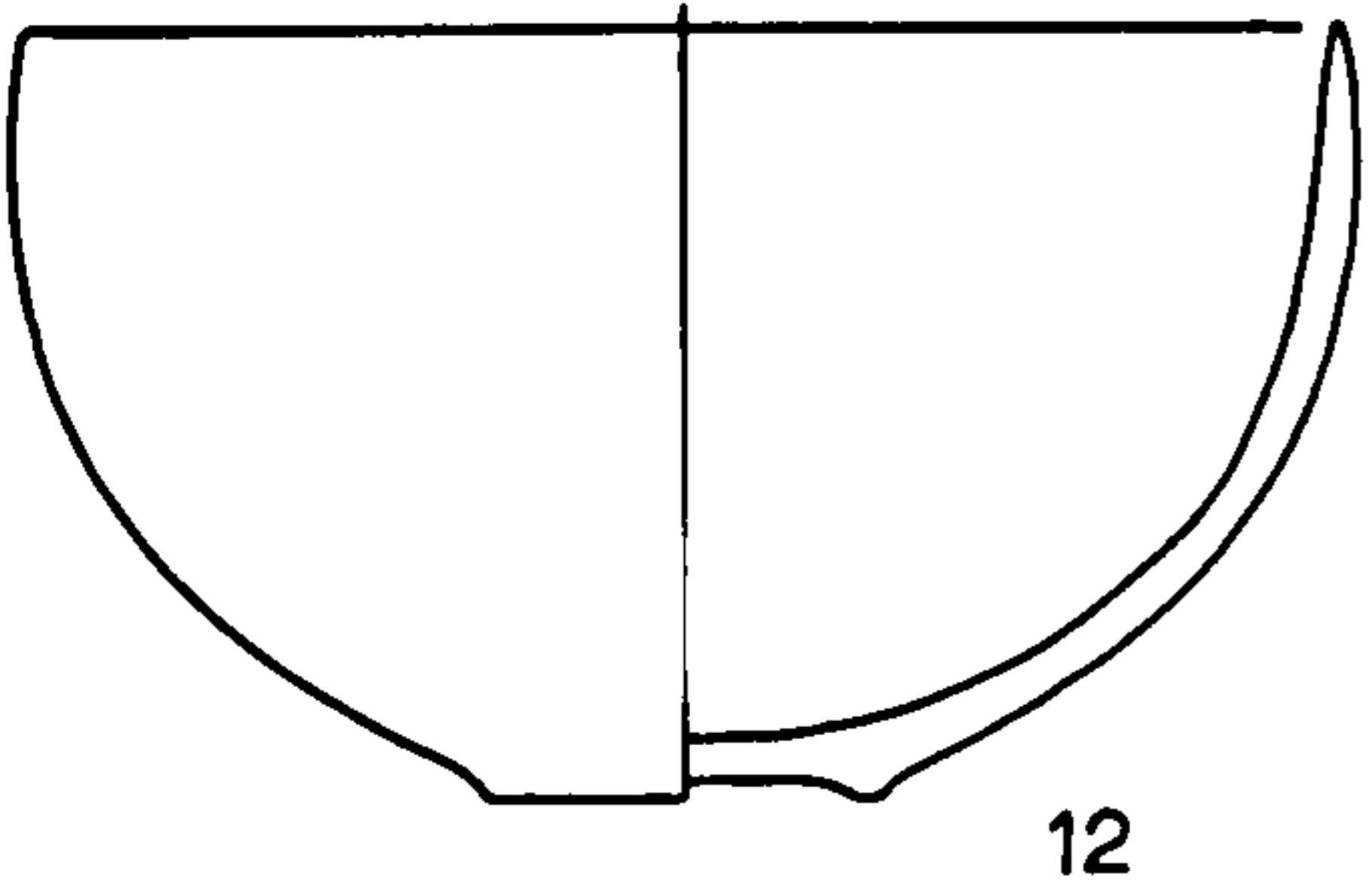
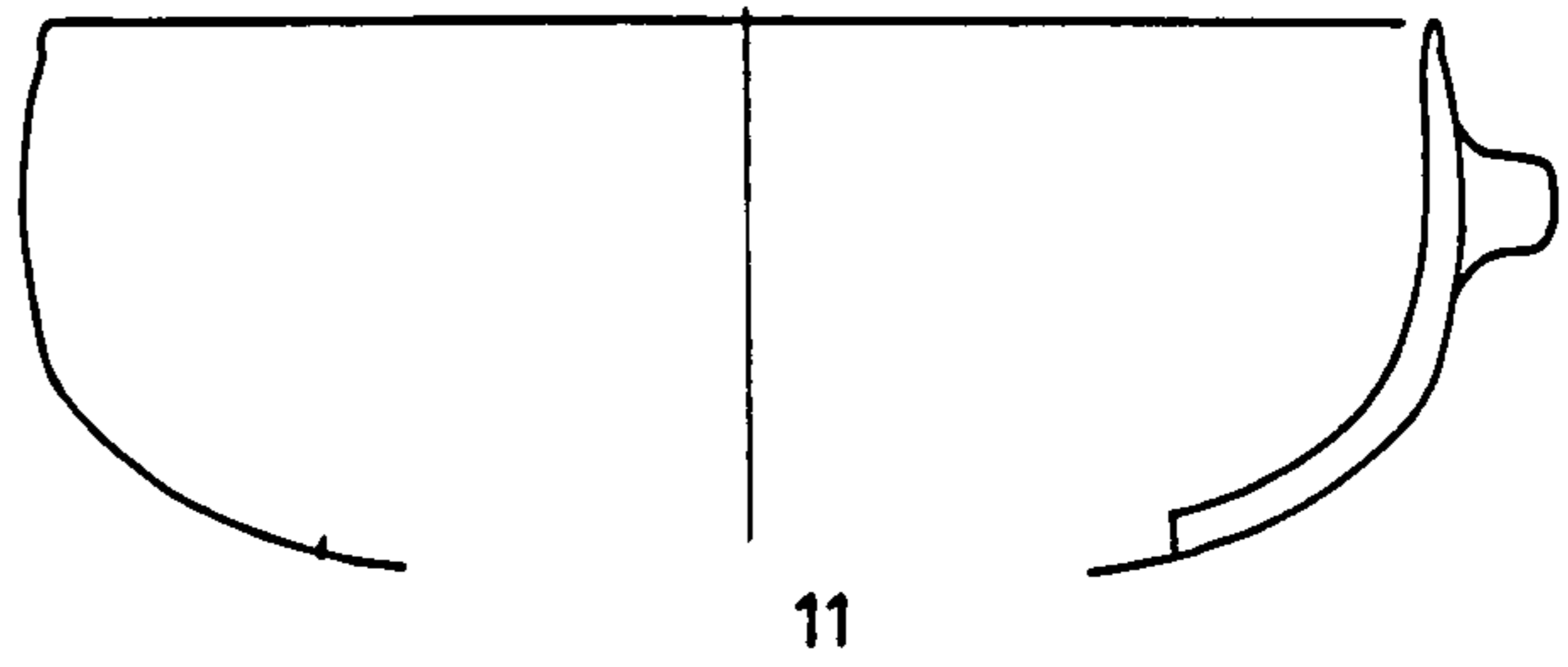
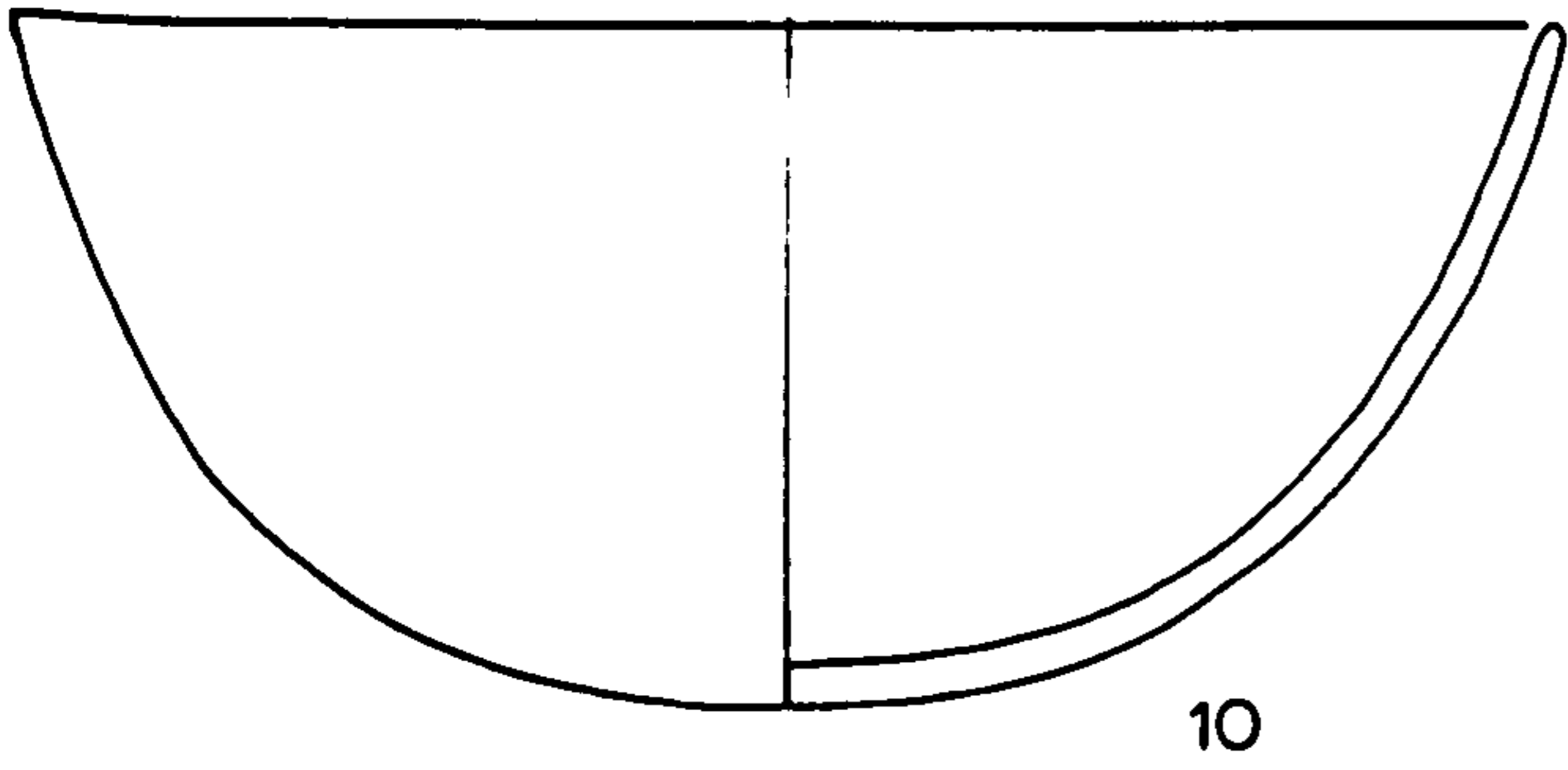
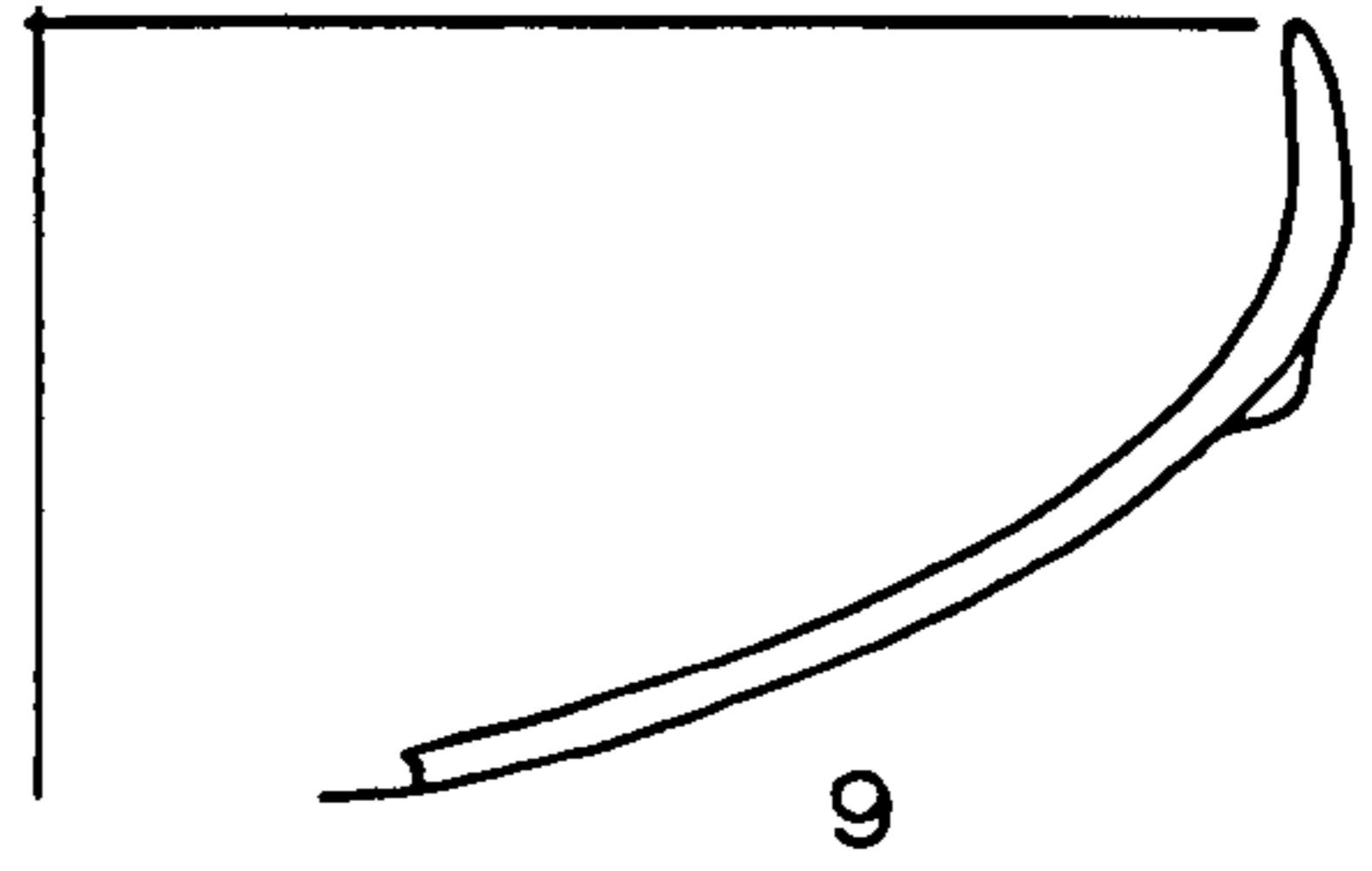
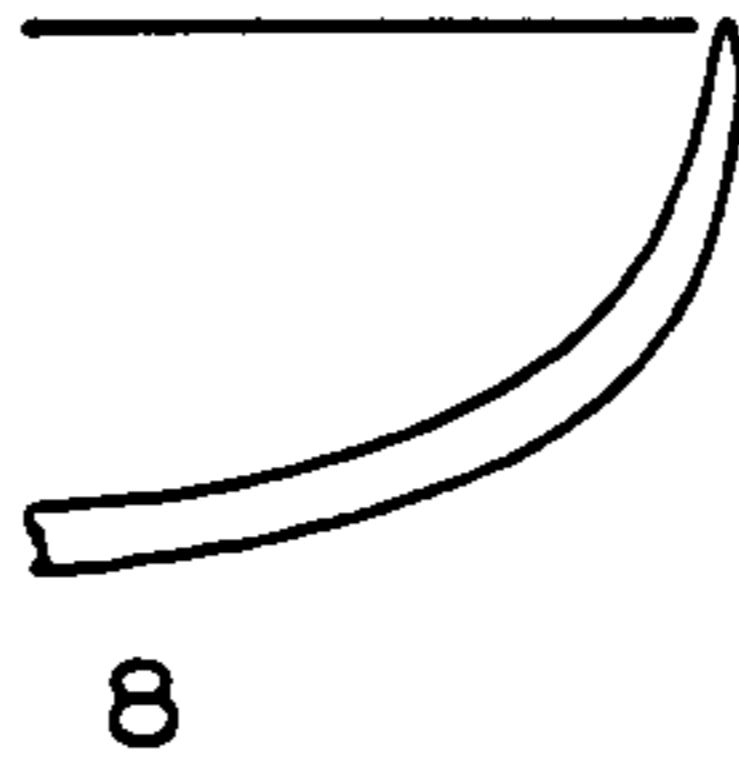
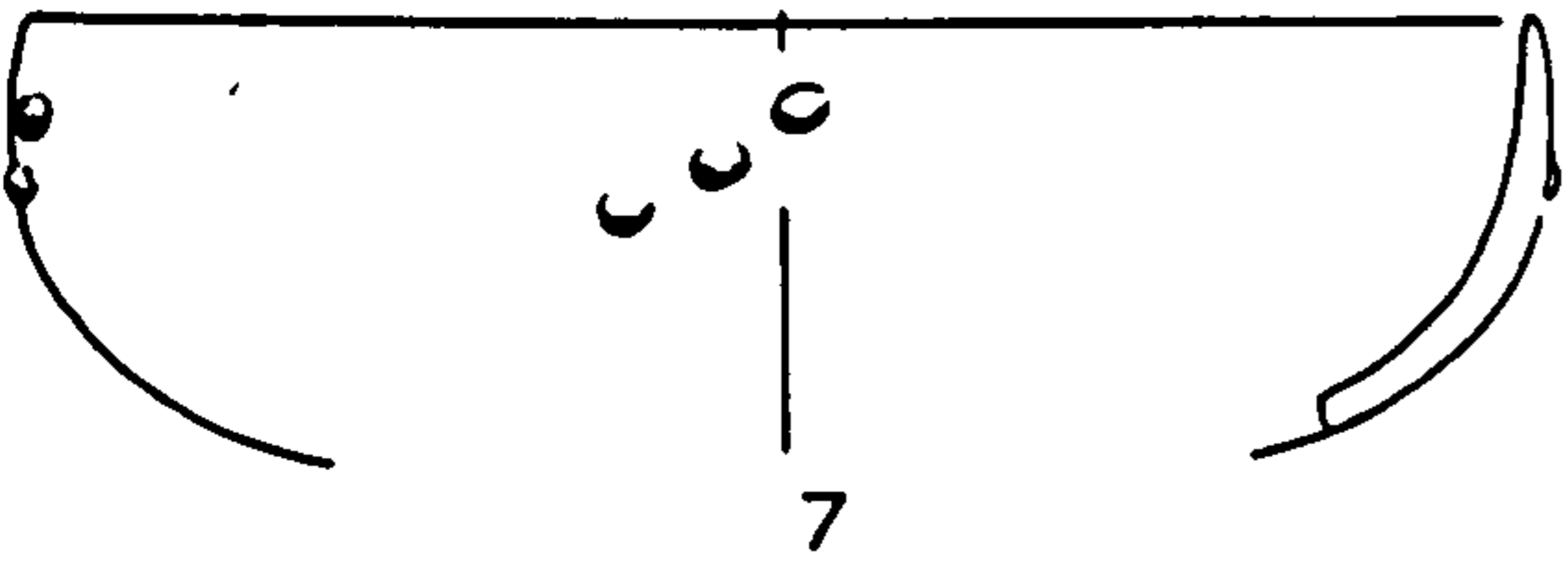
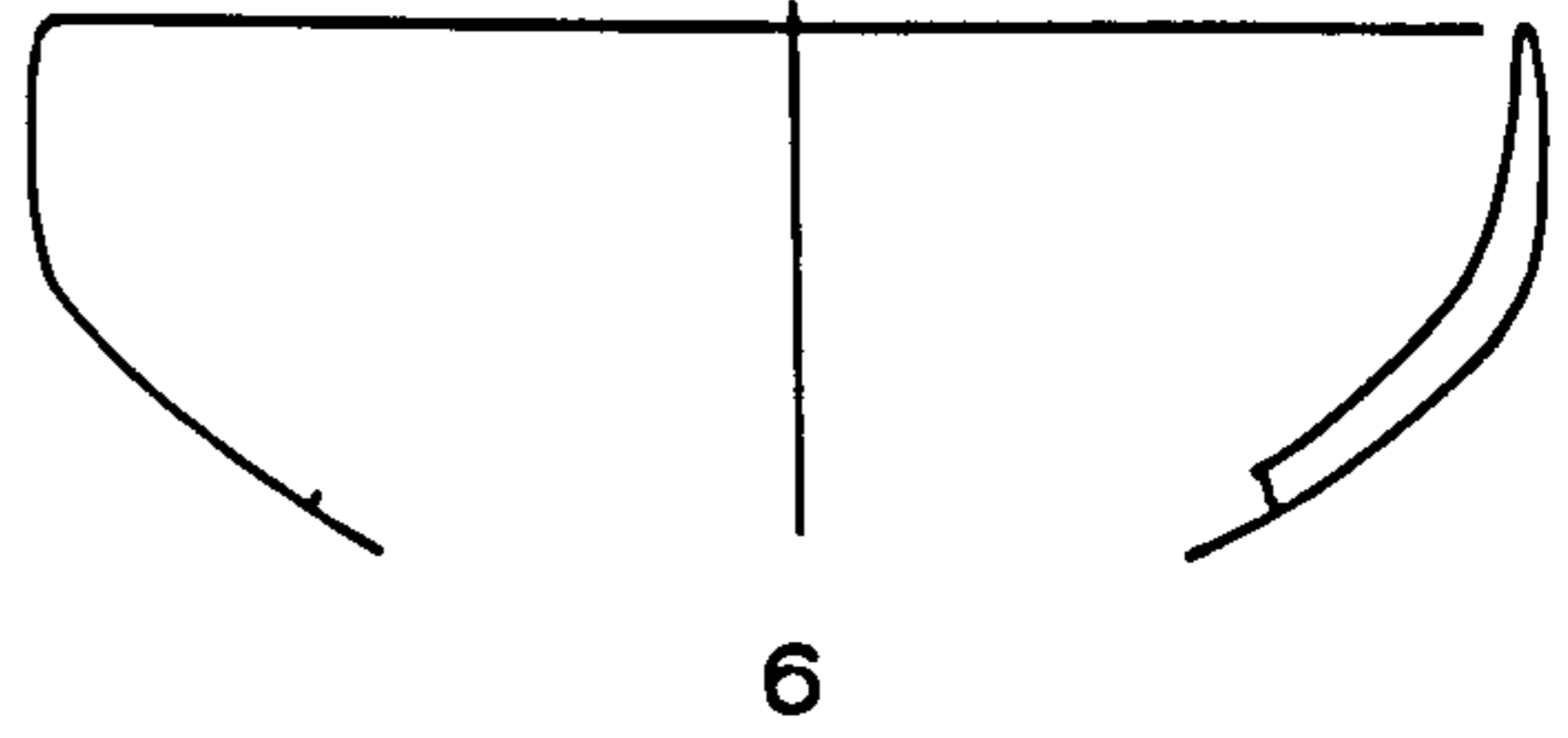
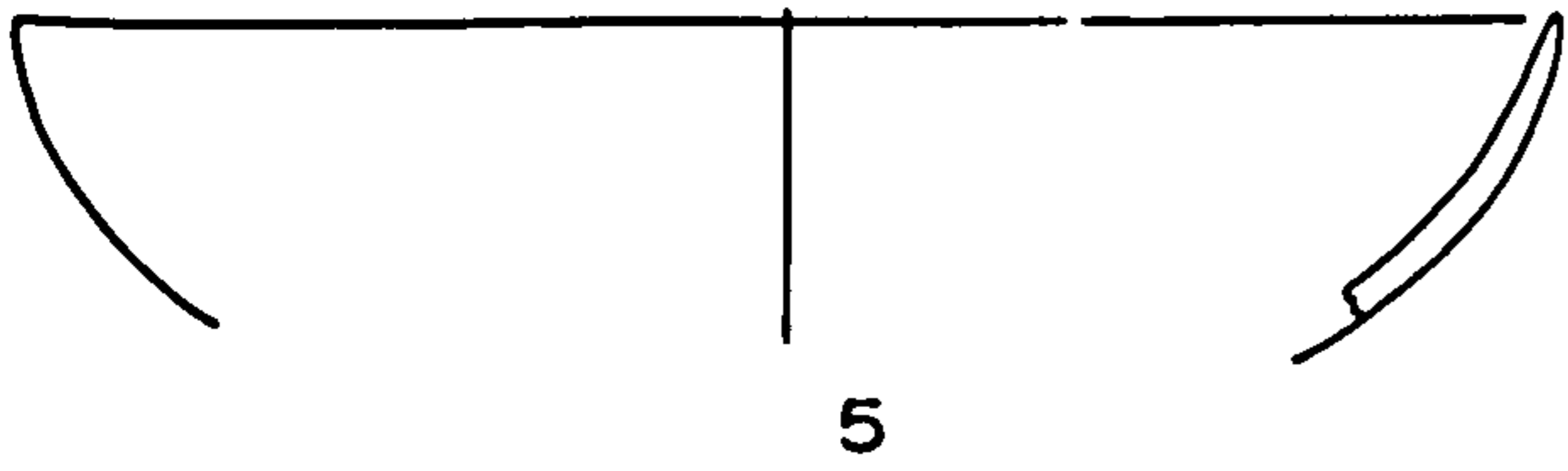
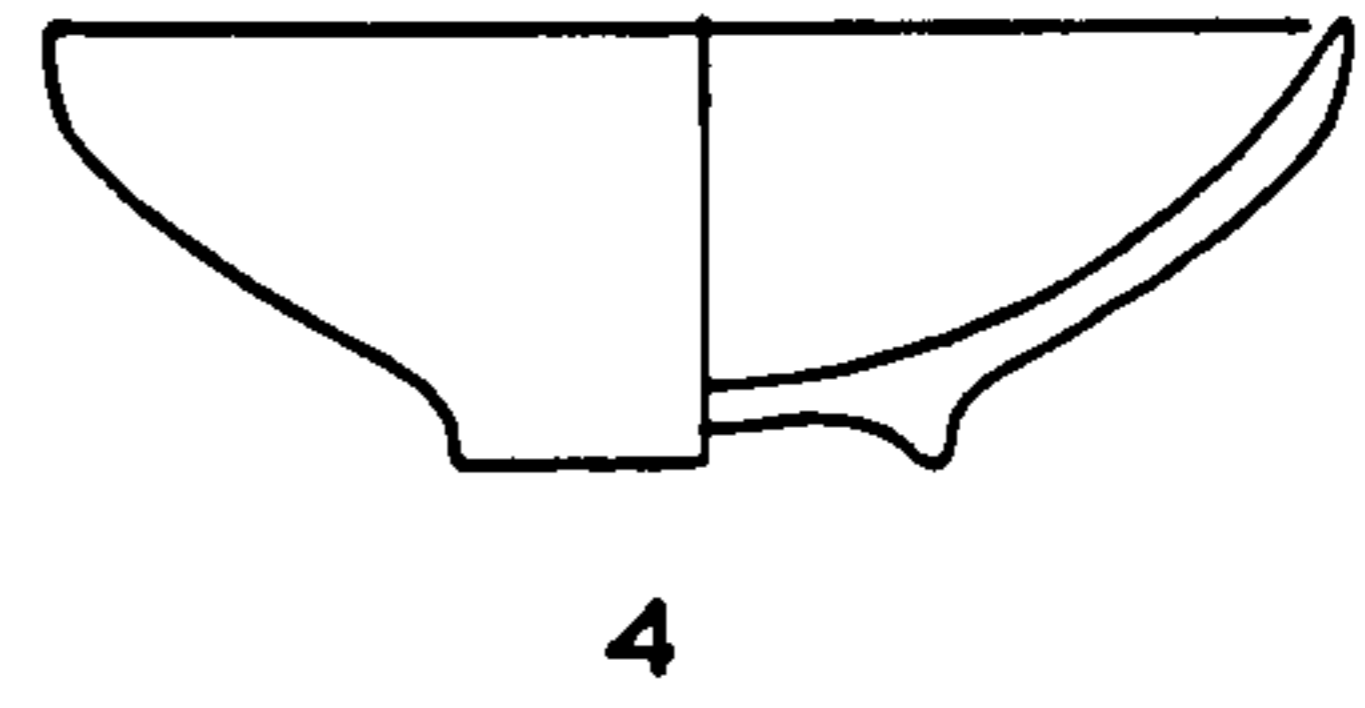
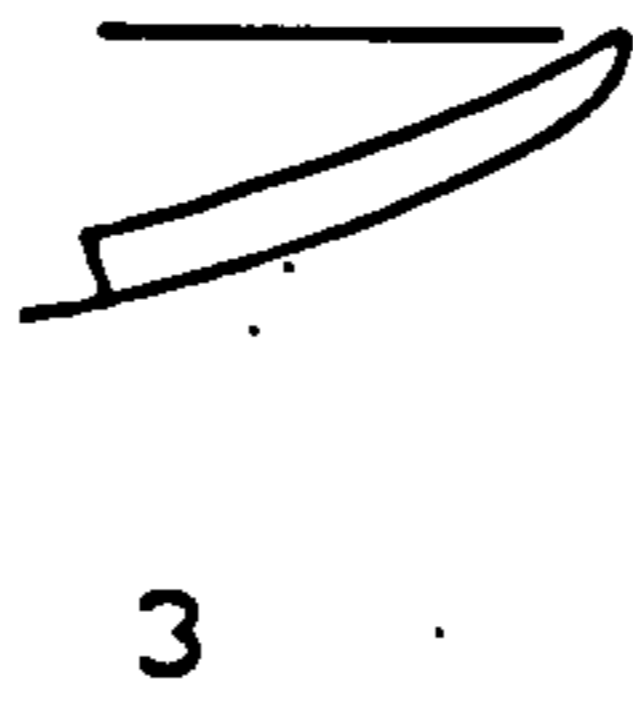
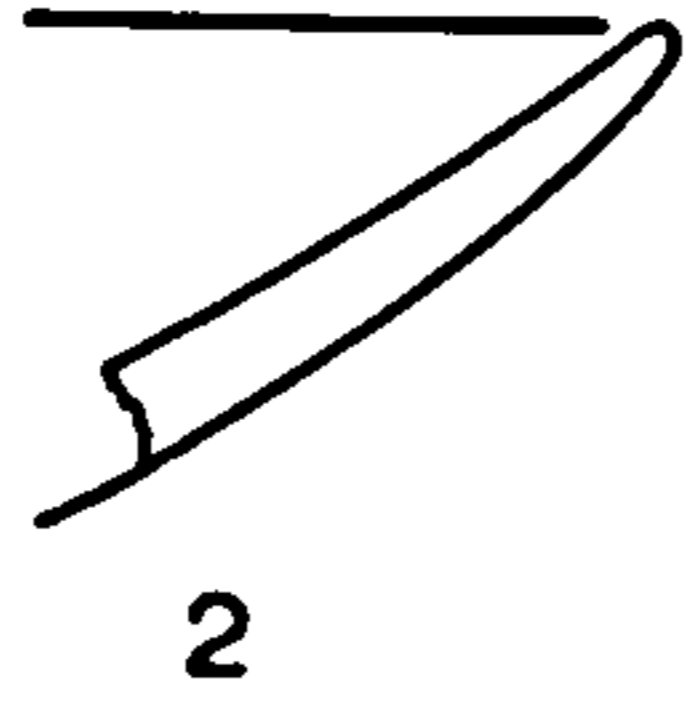
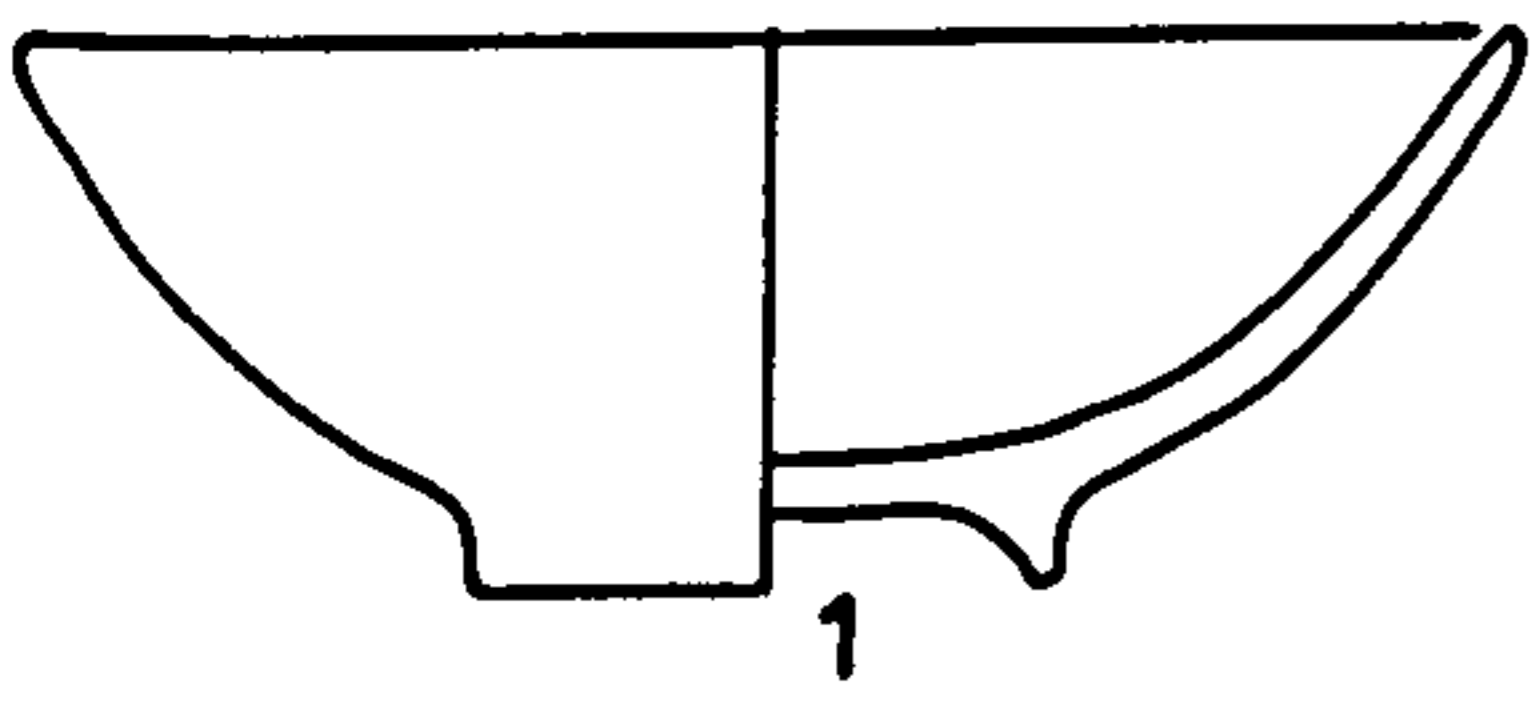
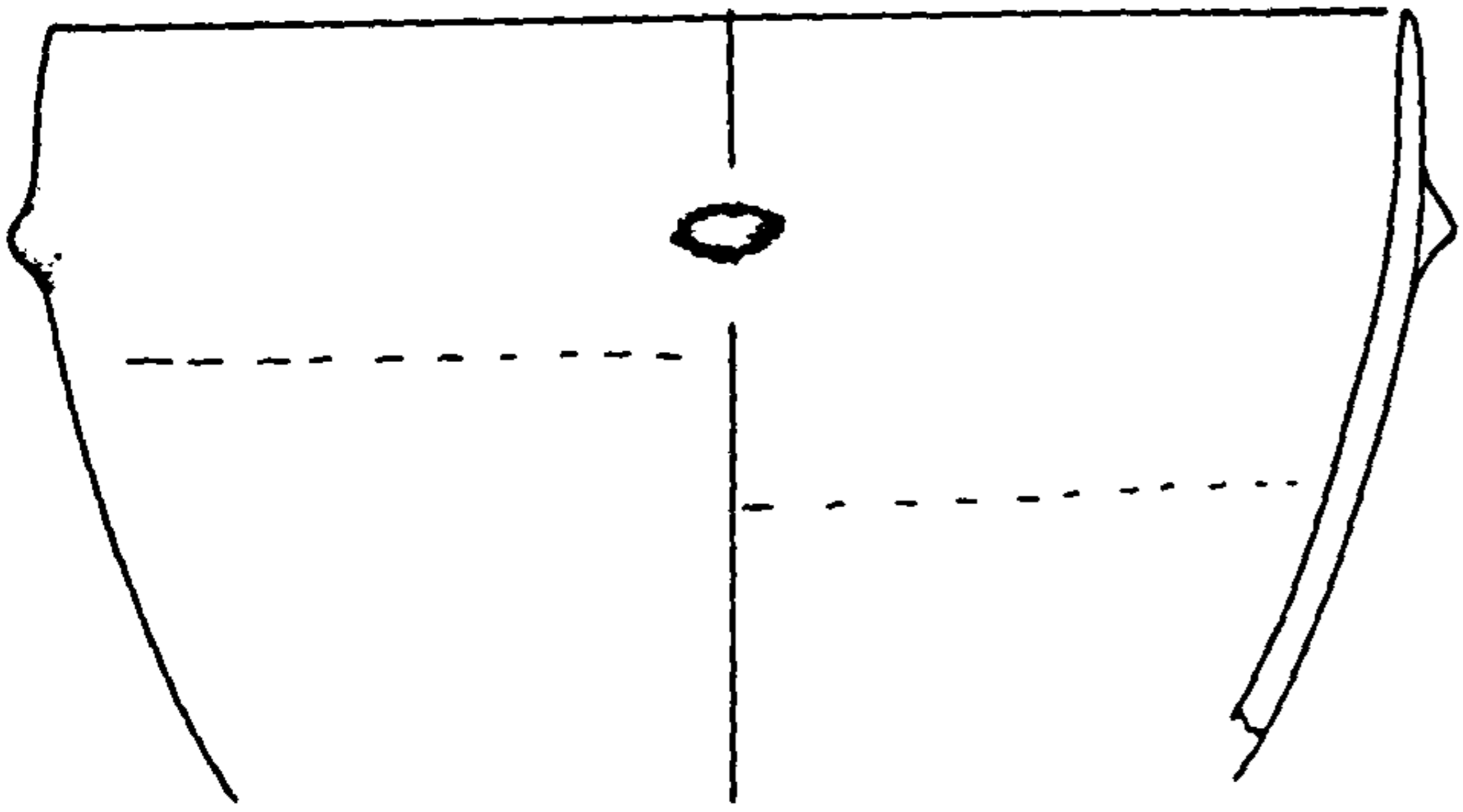
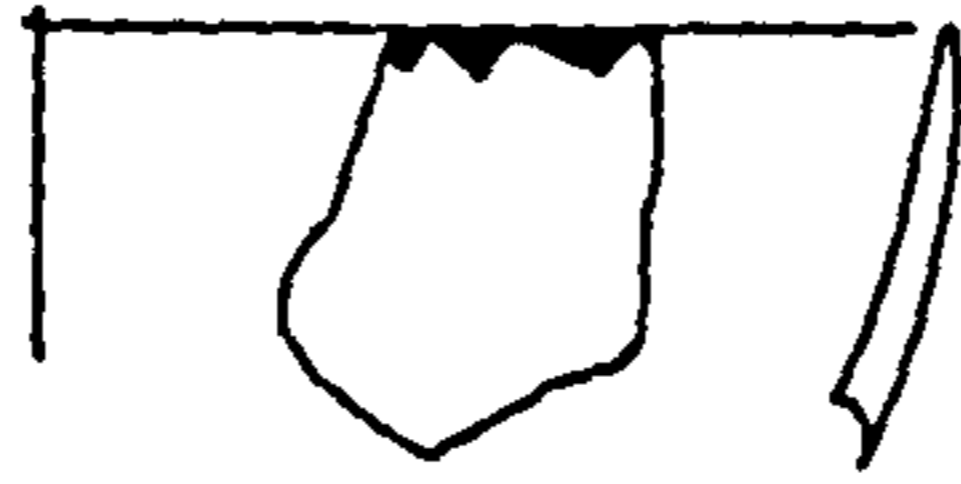

Fig.1



4



1



2



3

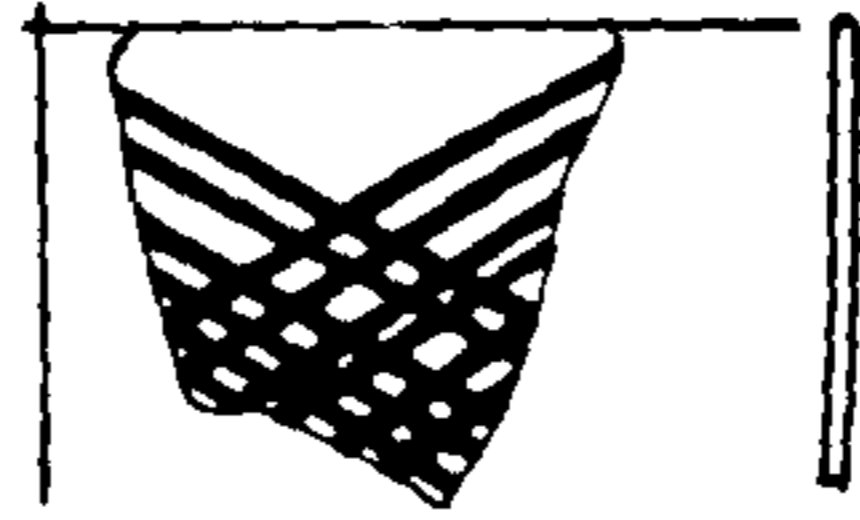

5

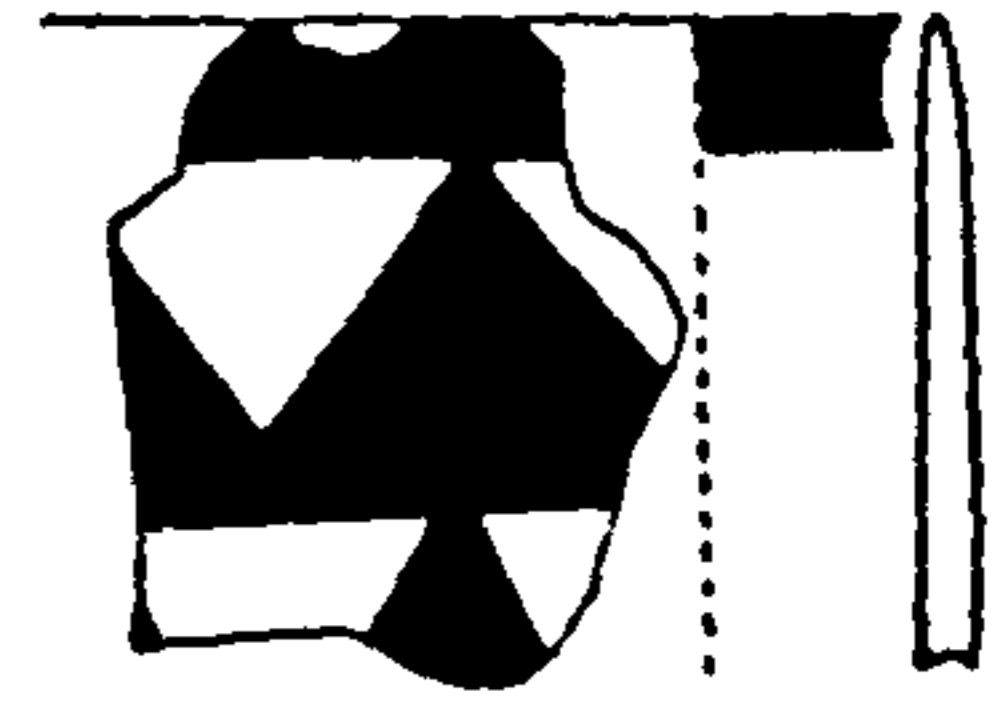

6

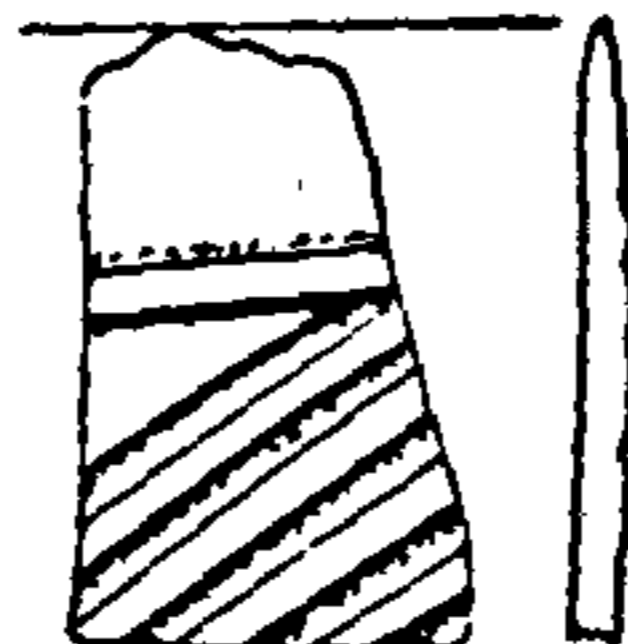

7

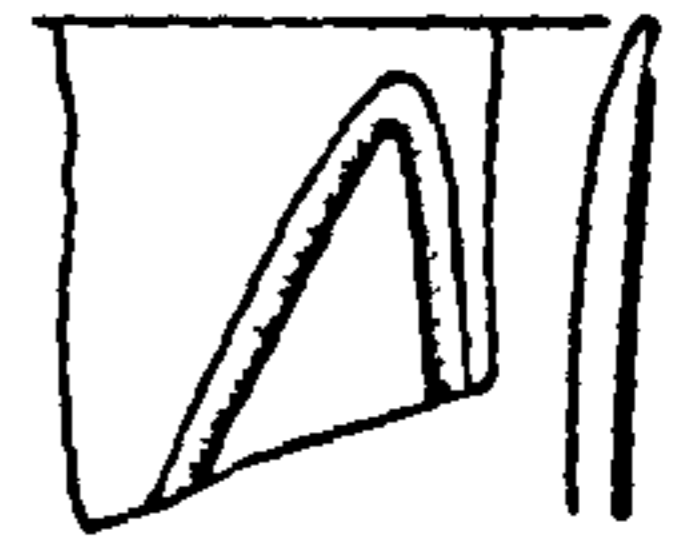

8



9

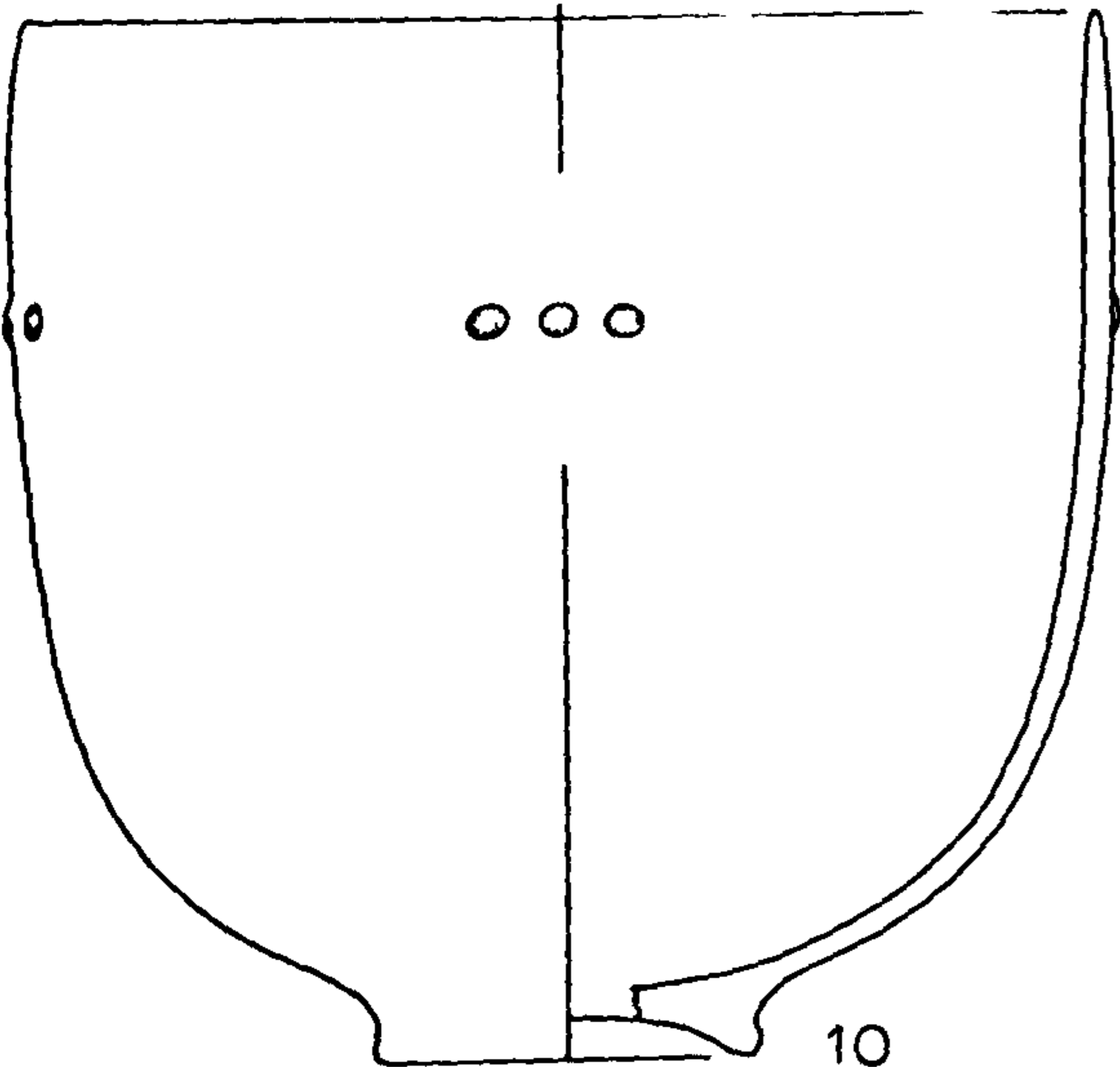

10

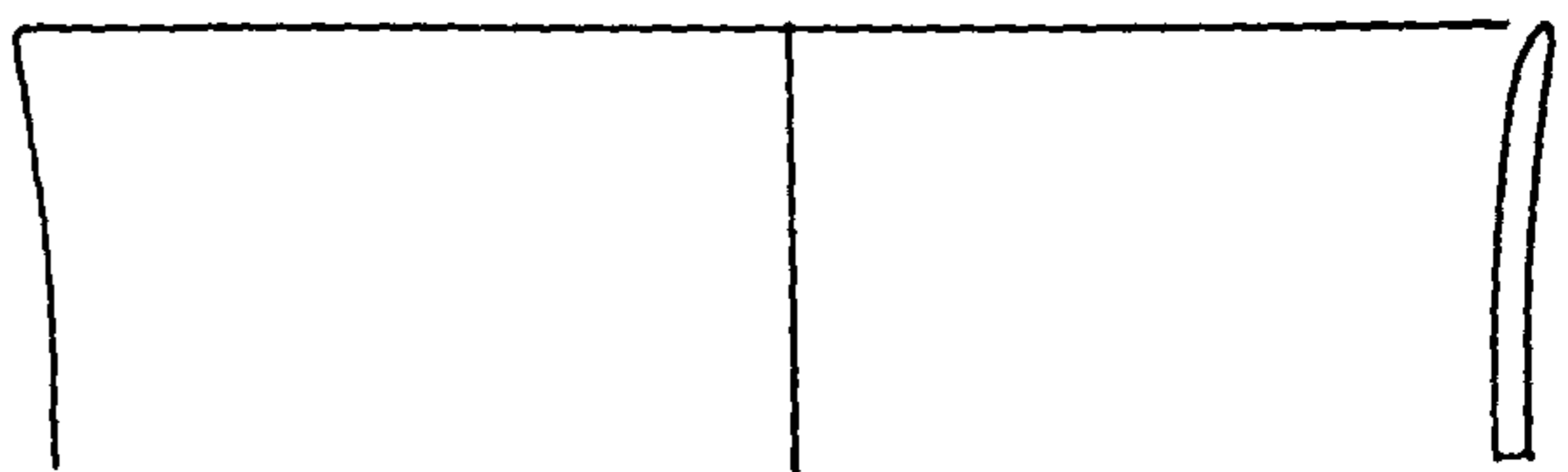

11

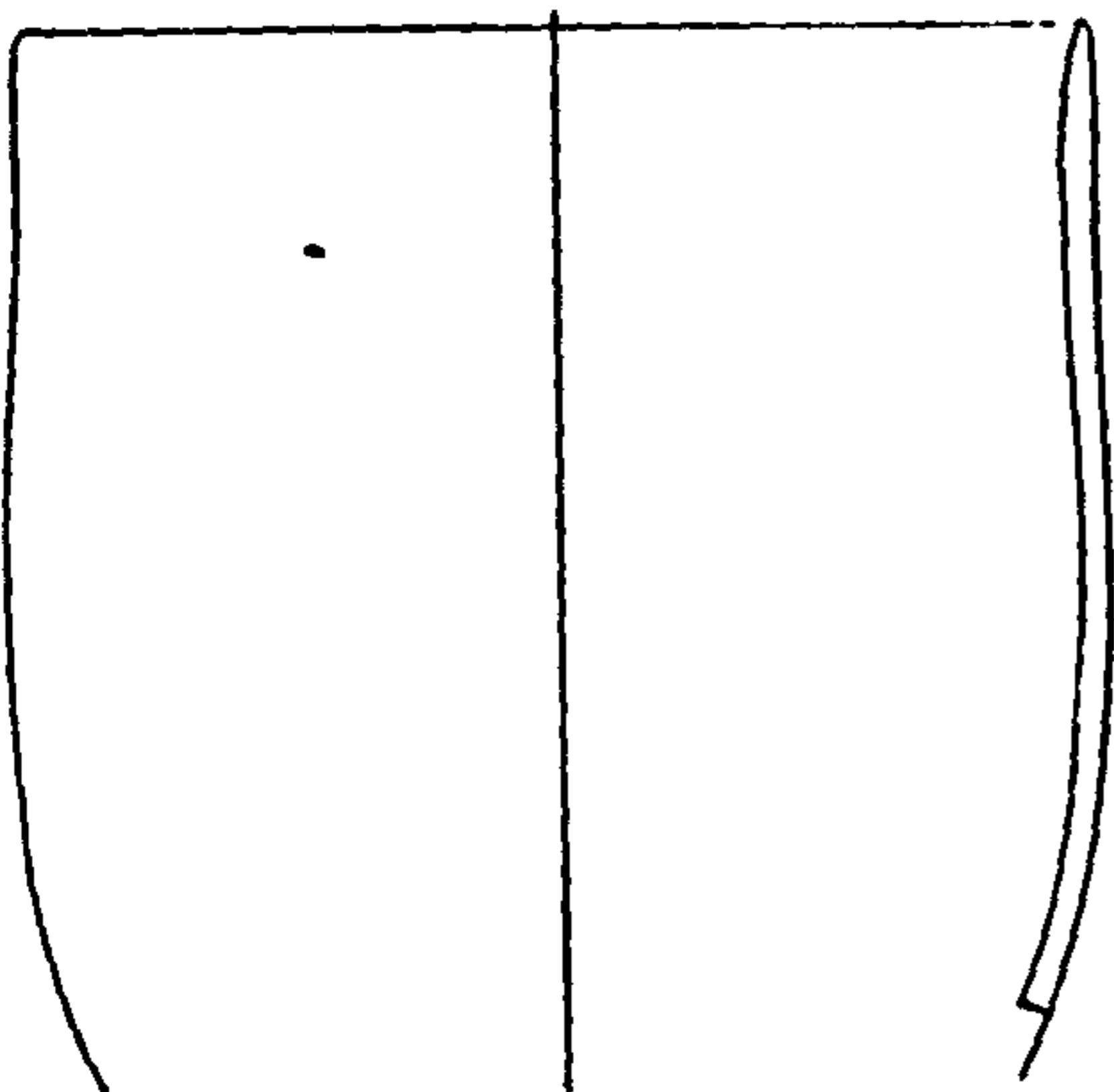

13

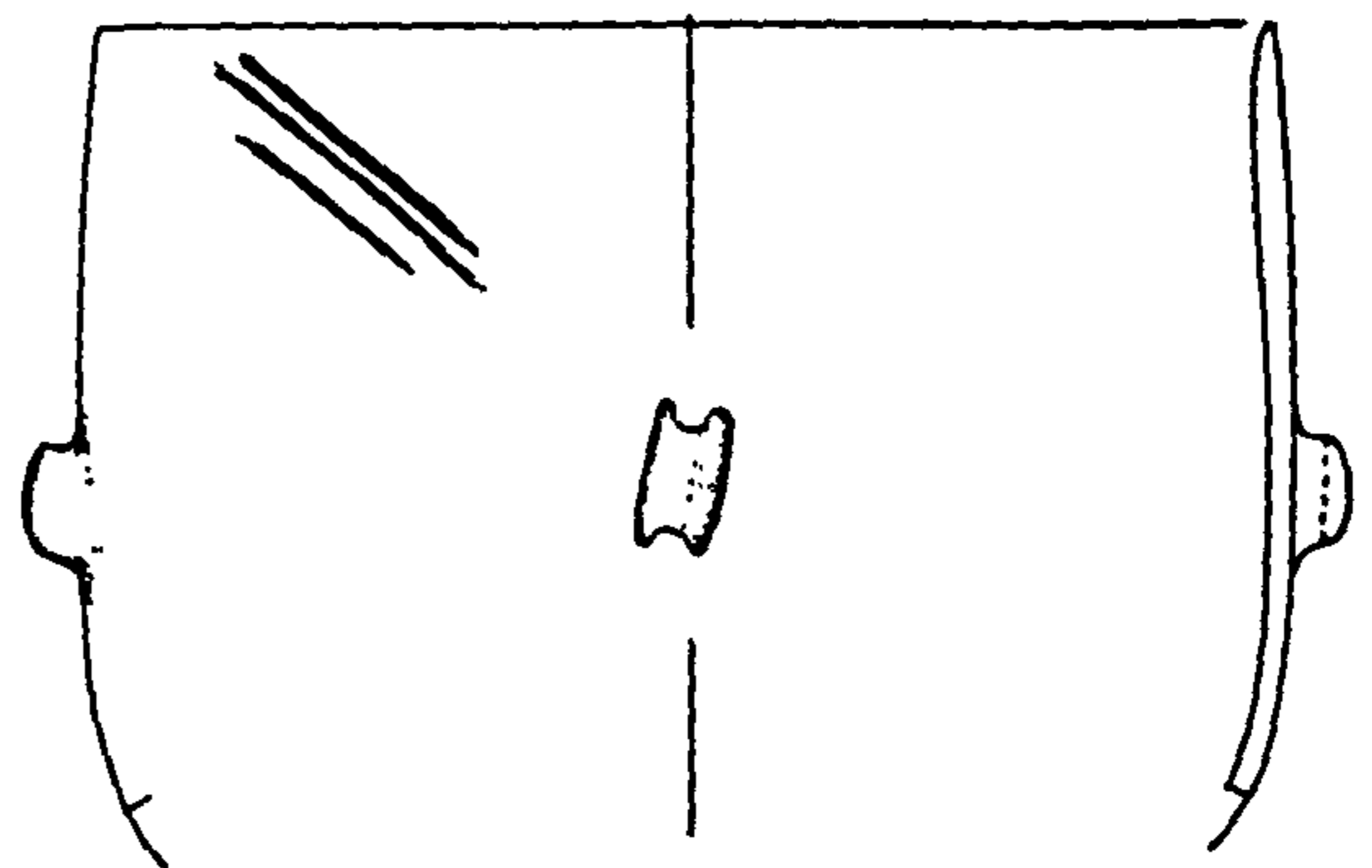

14

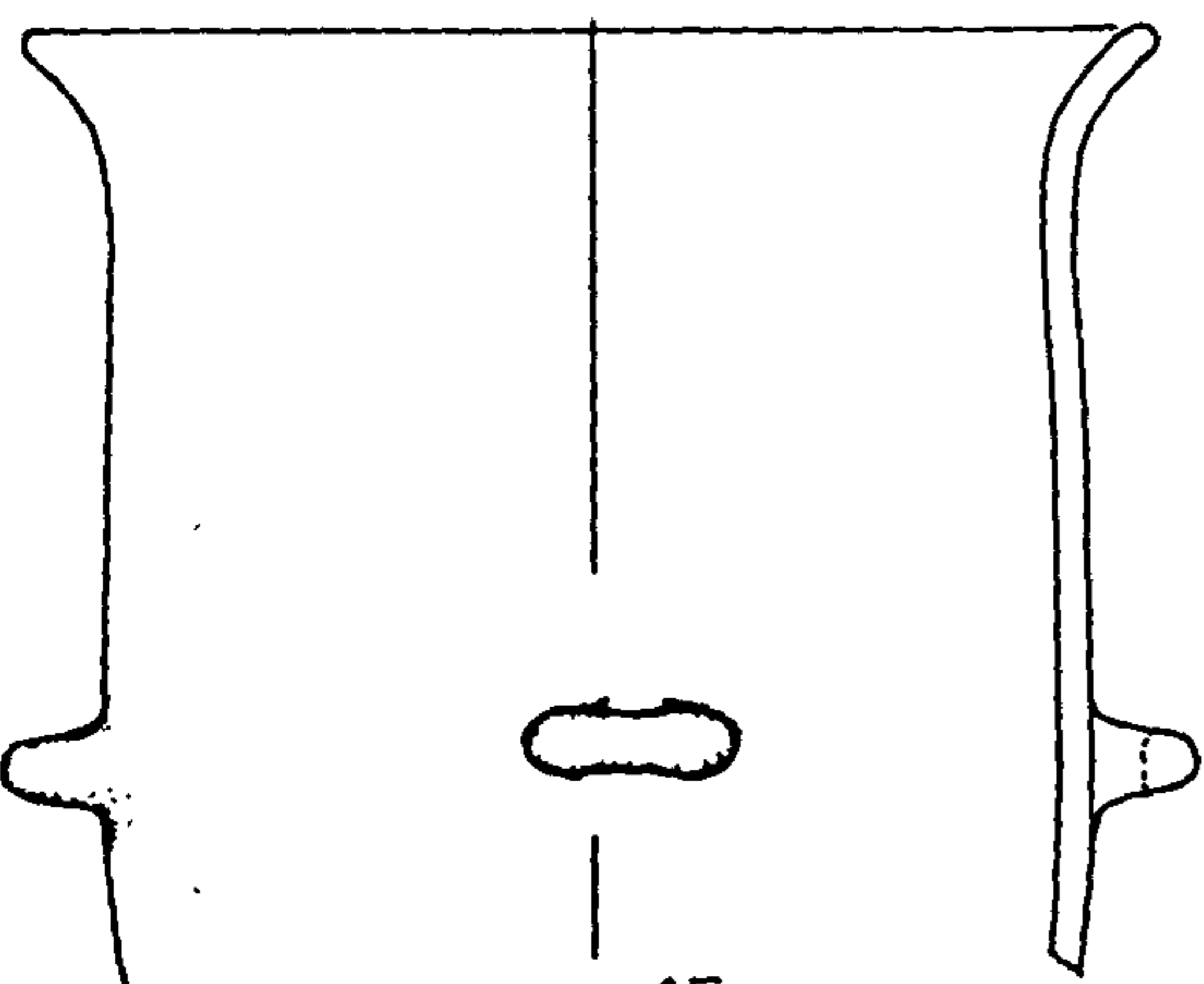

15

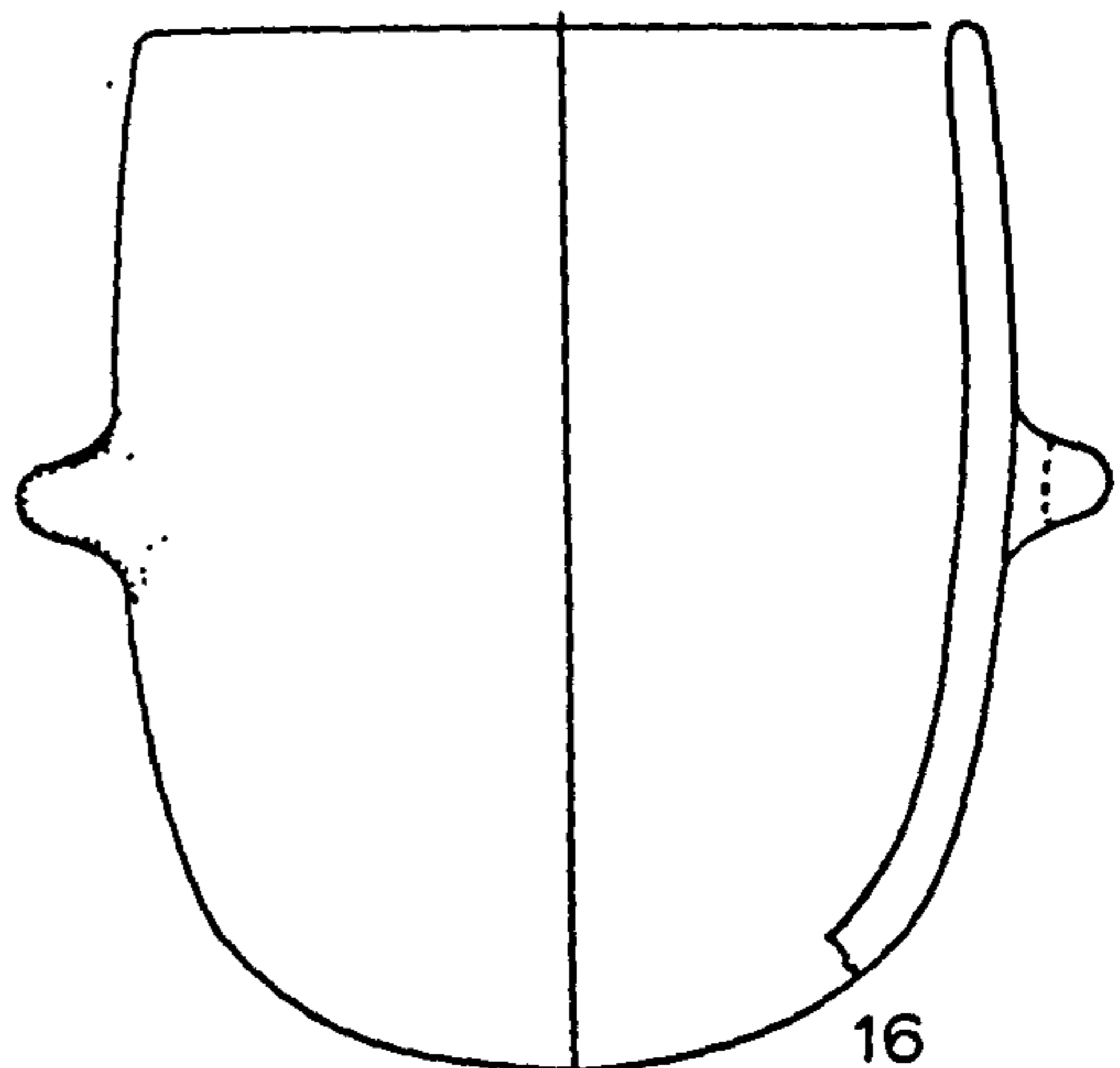

16



Fig. 2

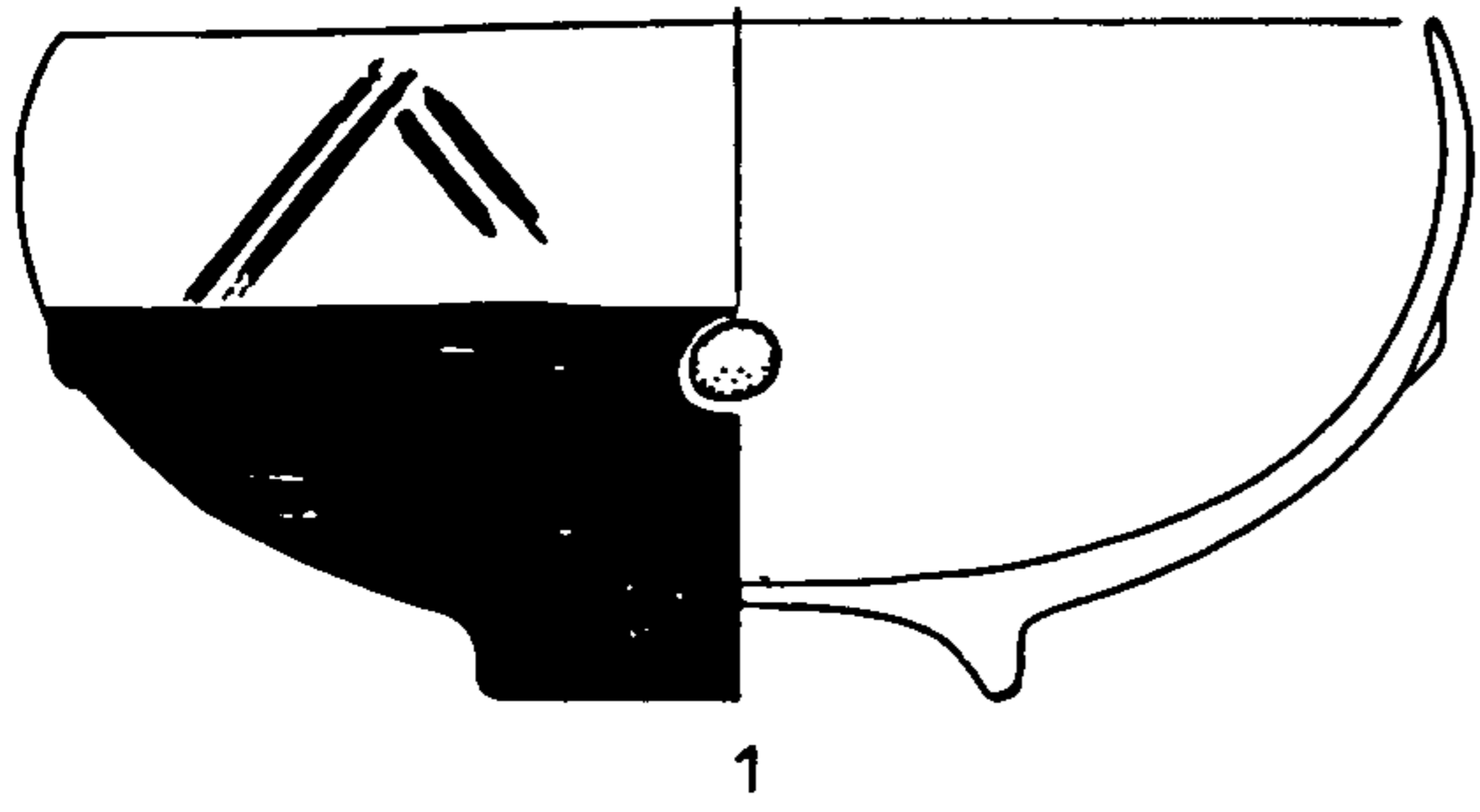

1

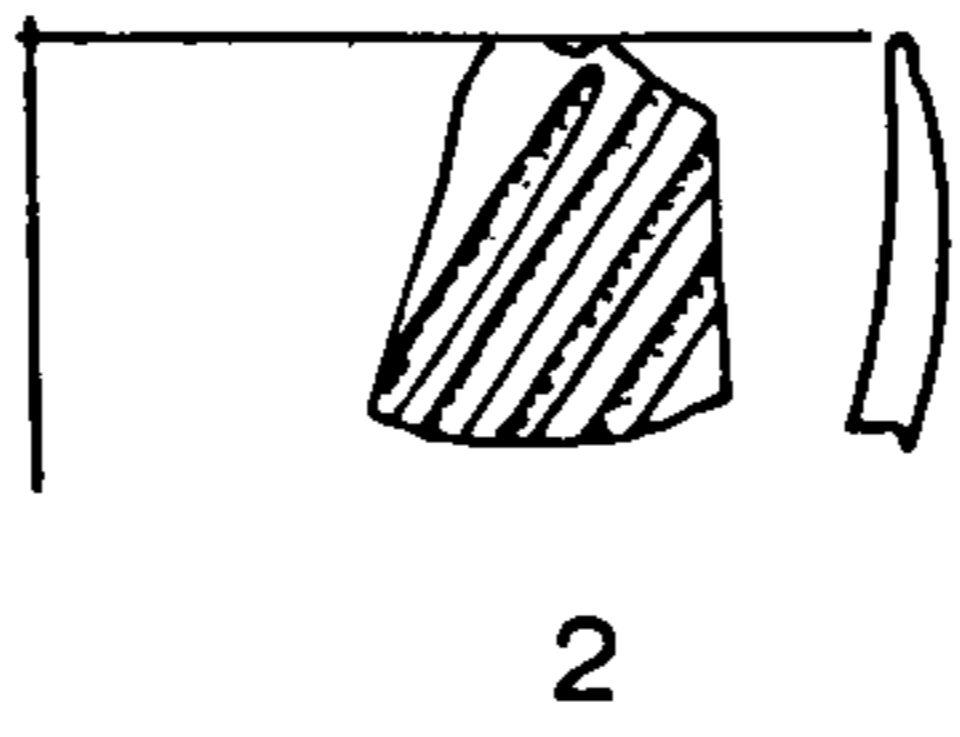

2

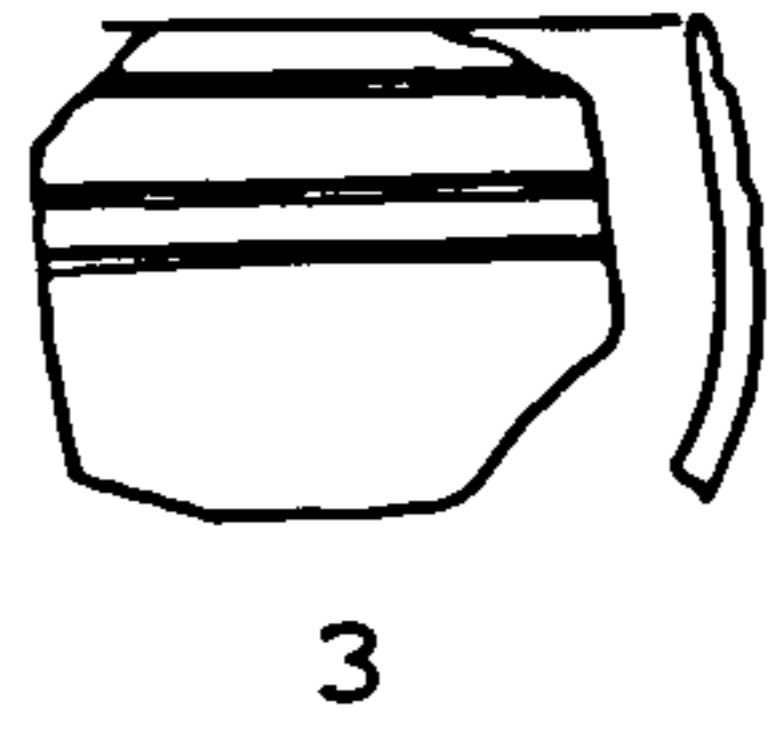

3

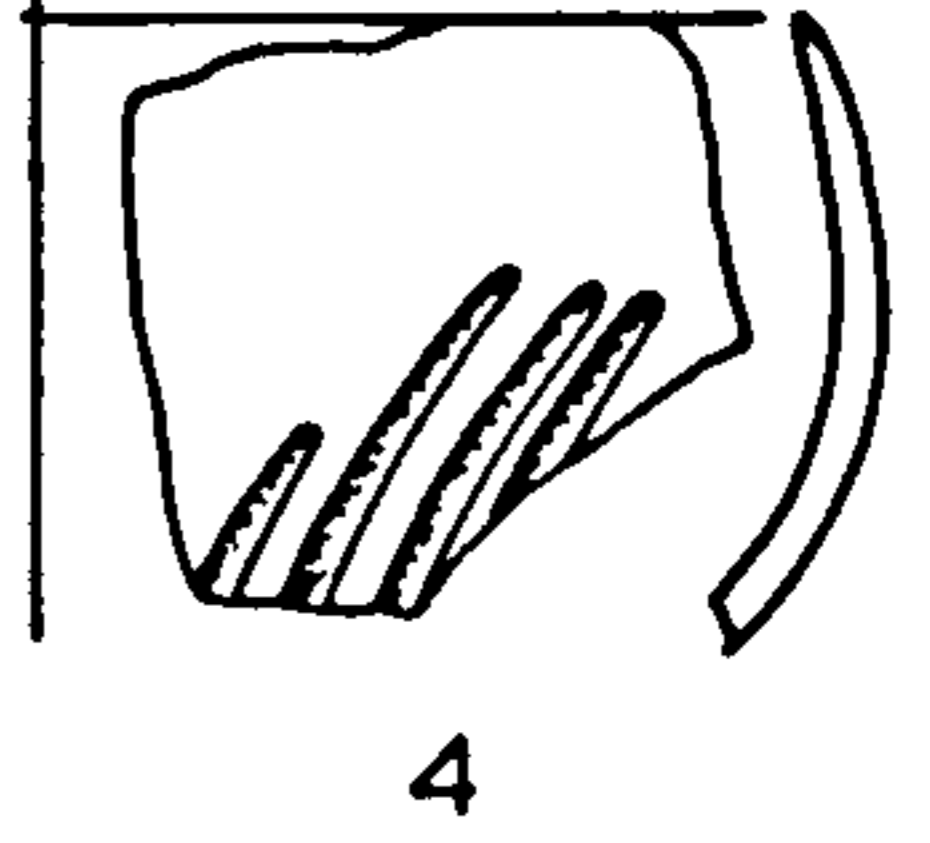

4

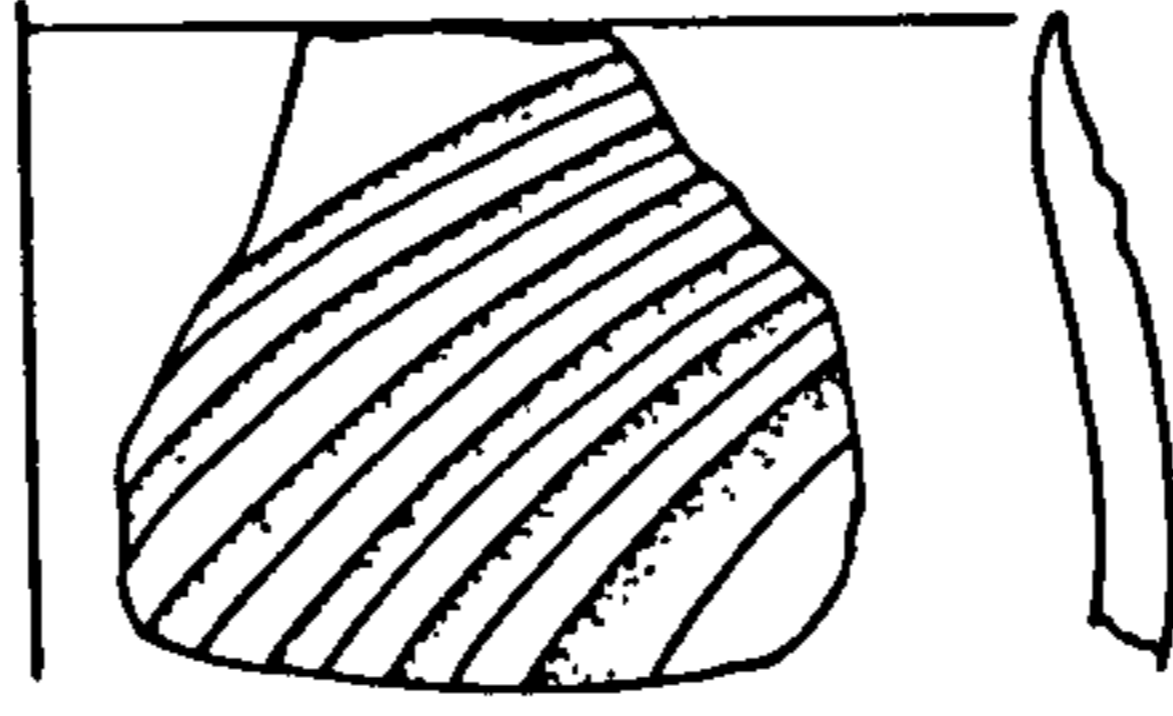

5

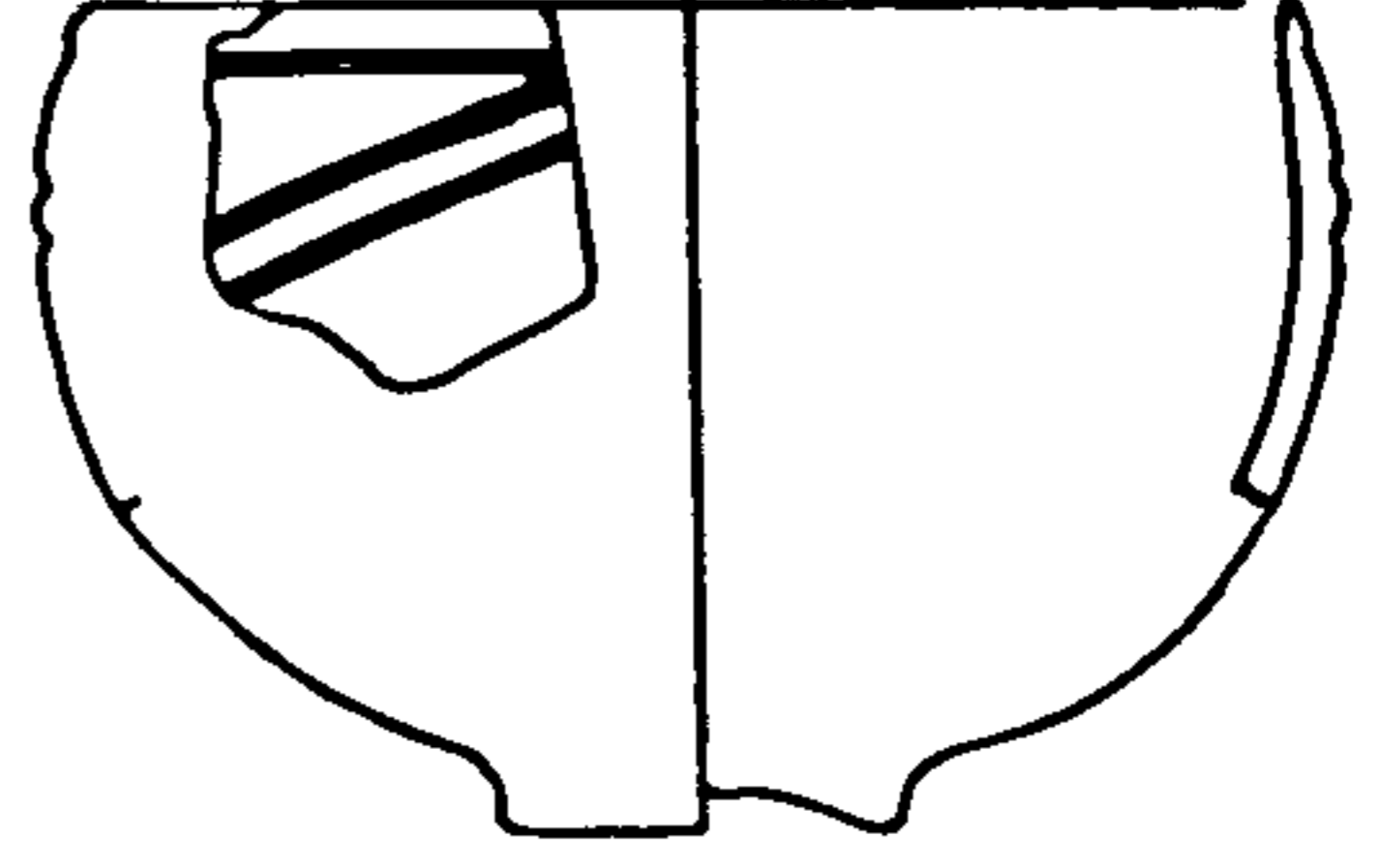

6

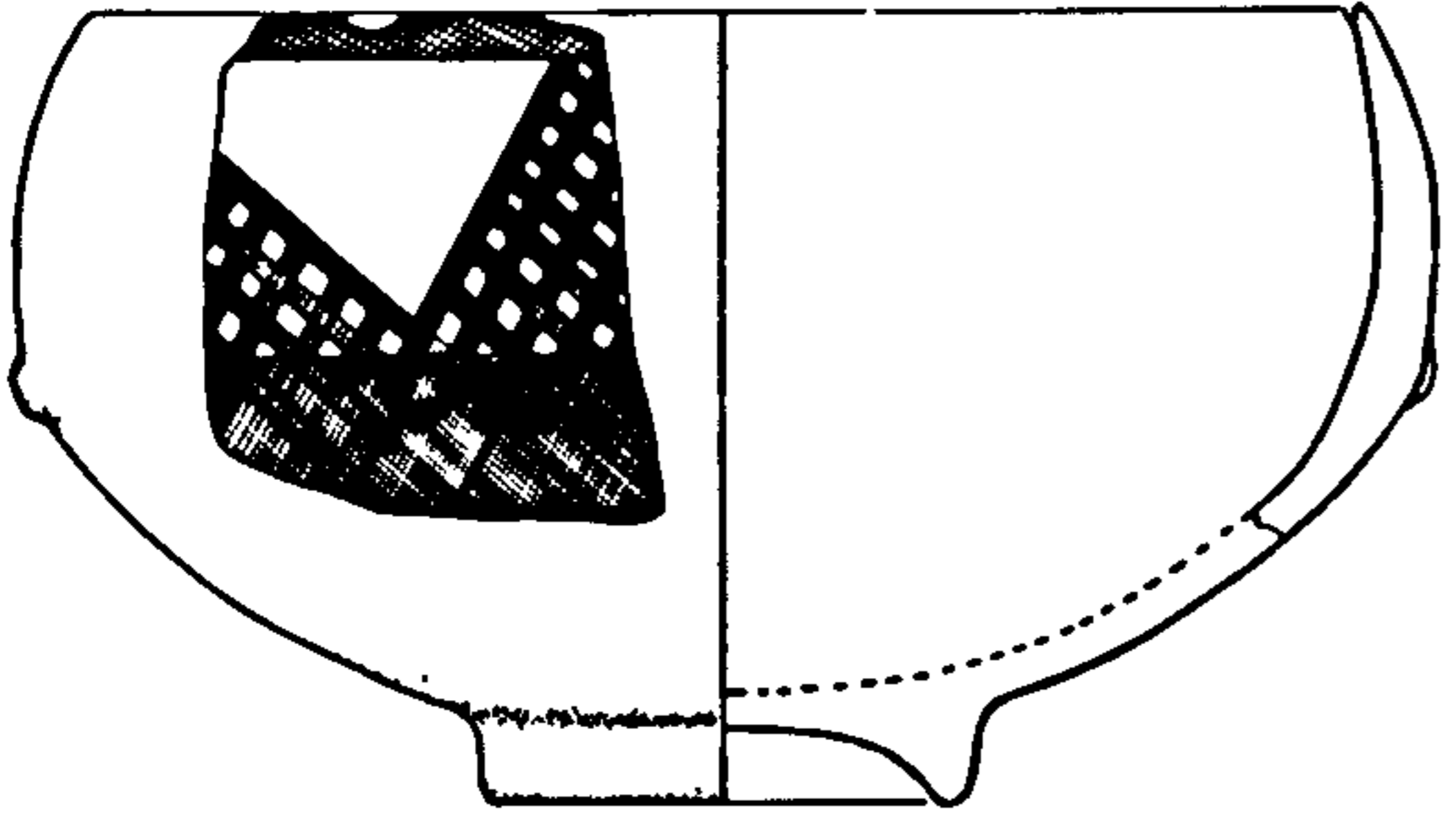

7

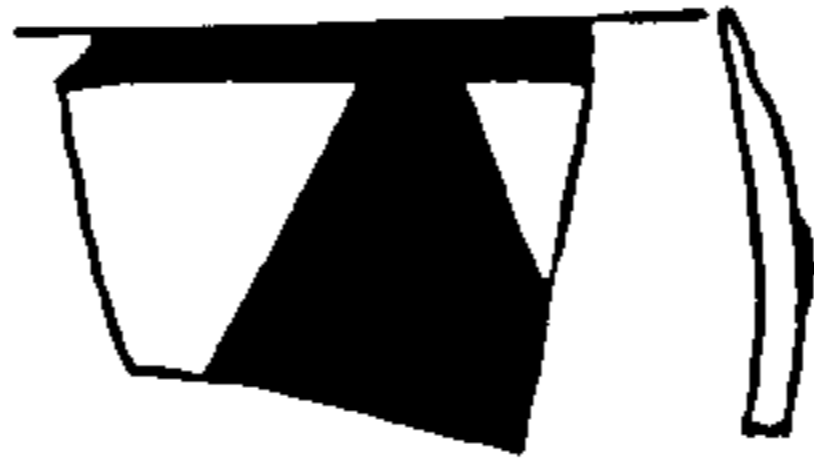

8

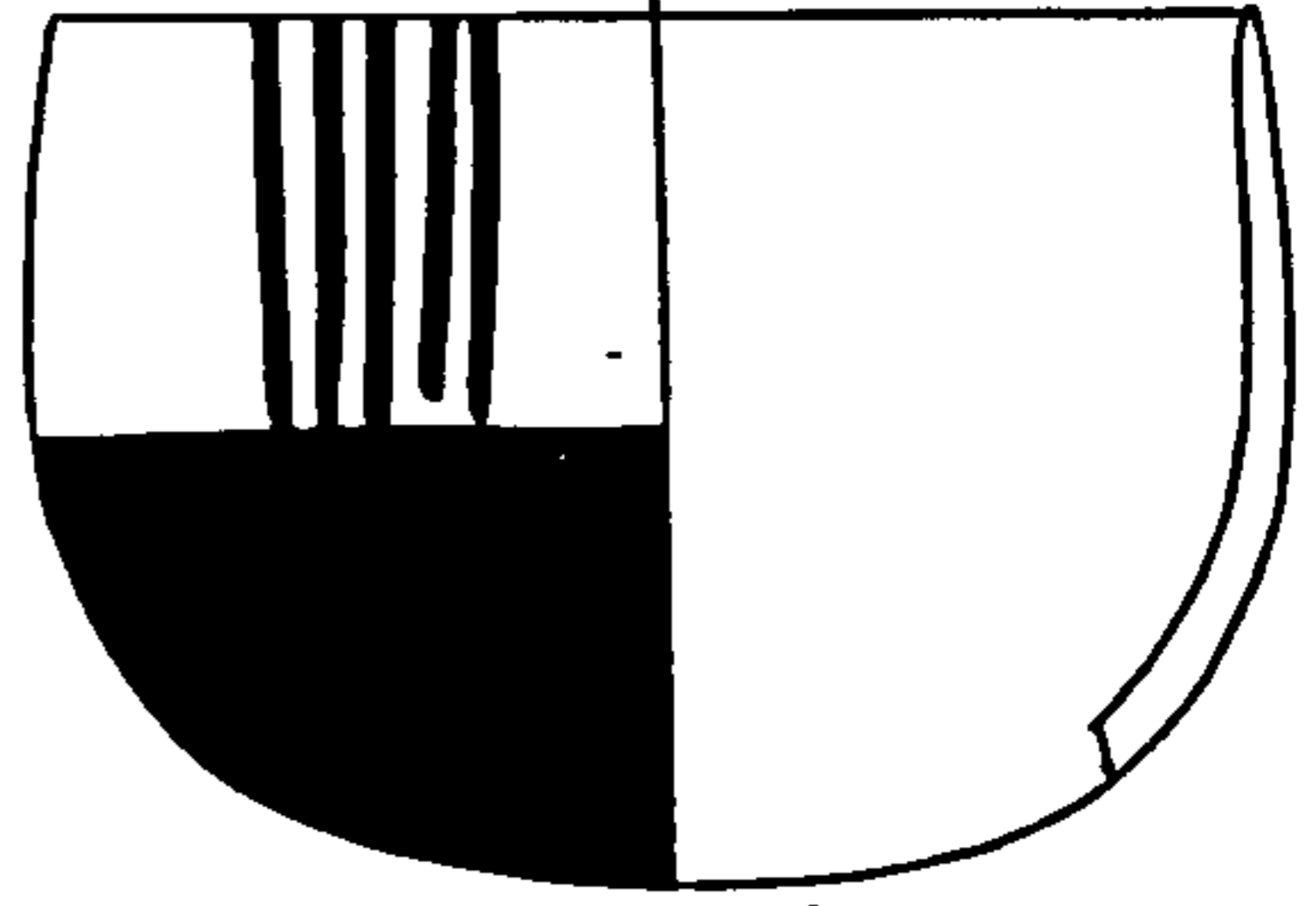

9

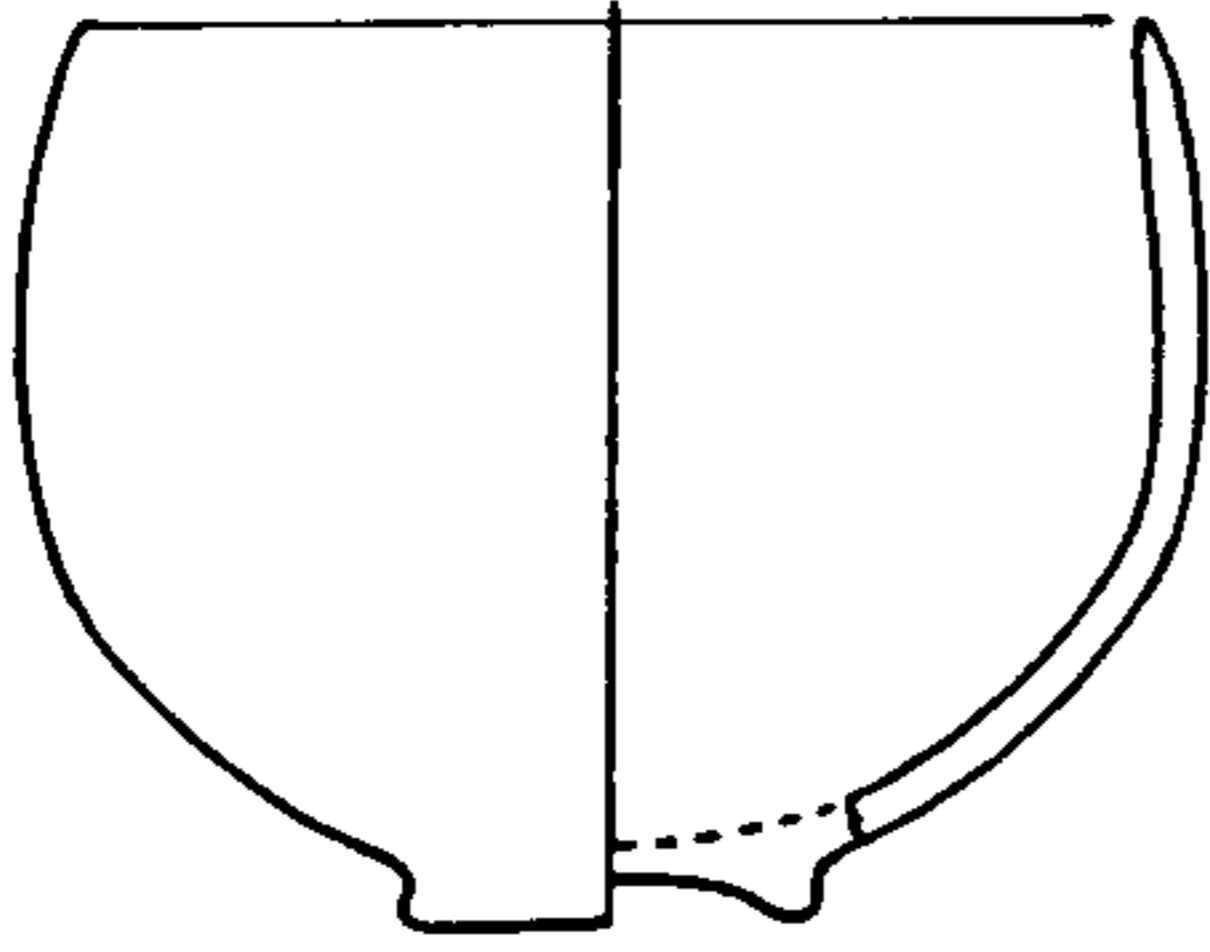

10

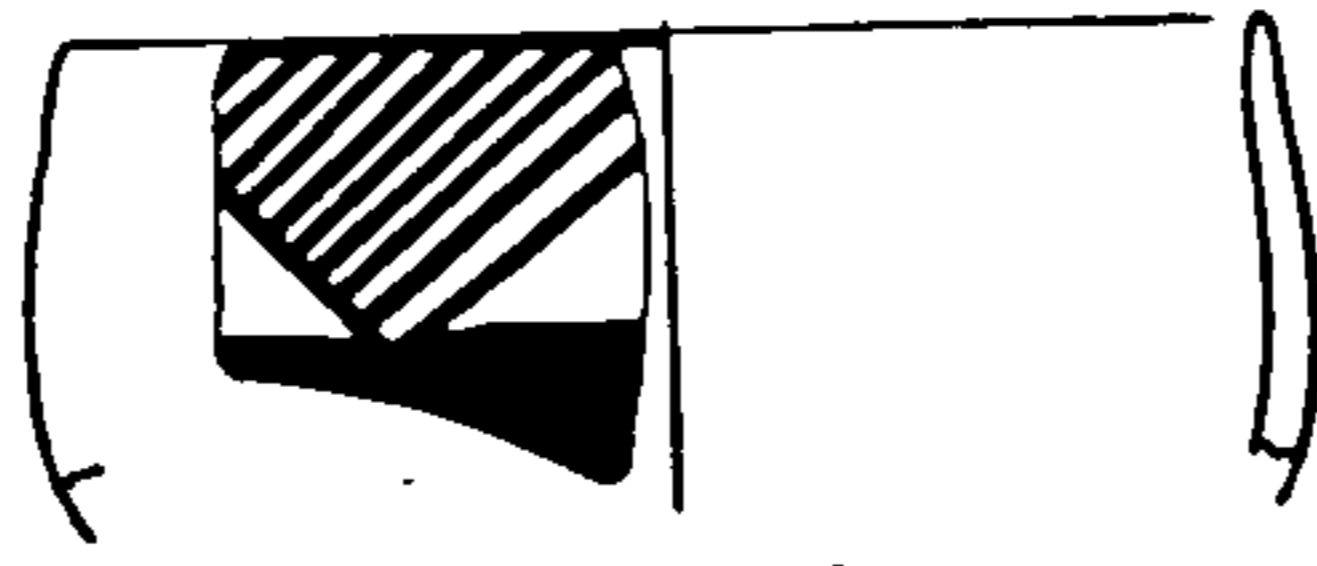

11

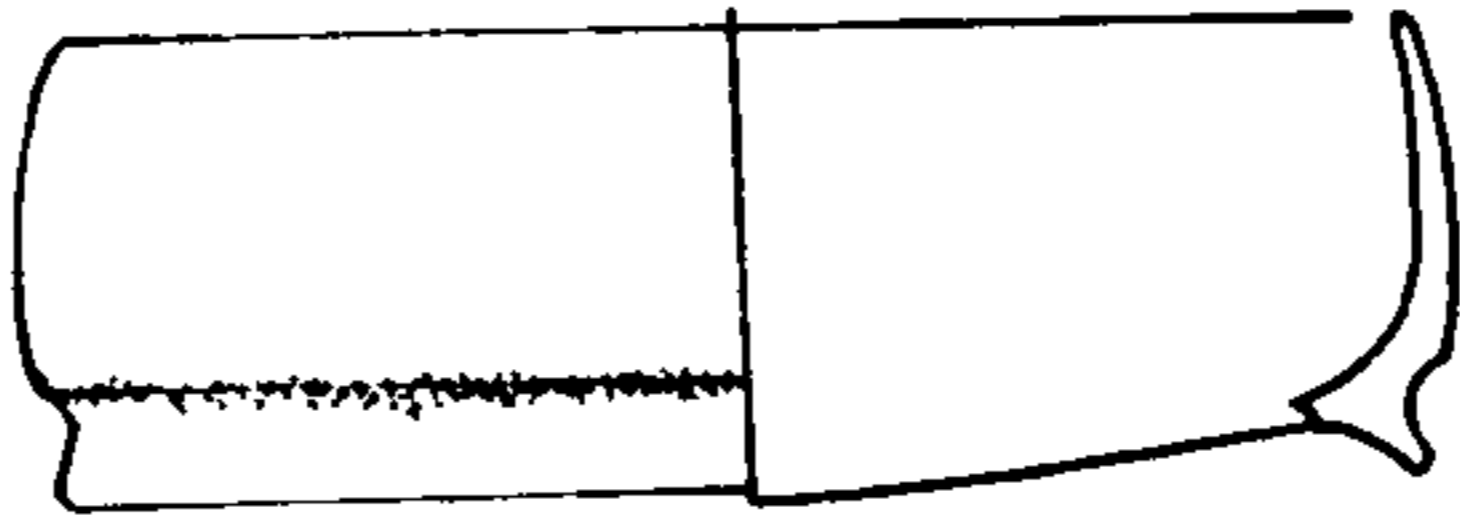

12

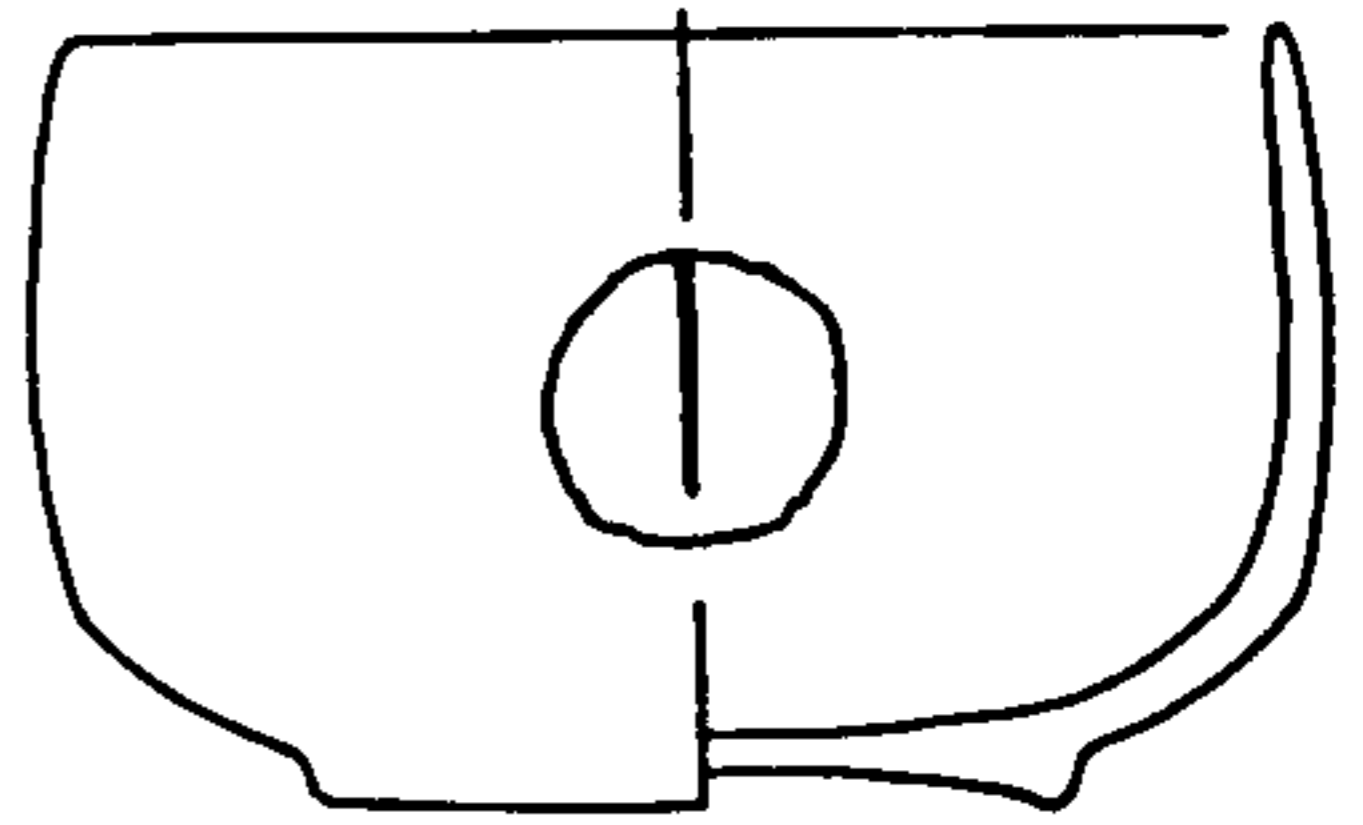

13

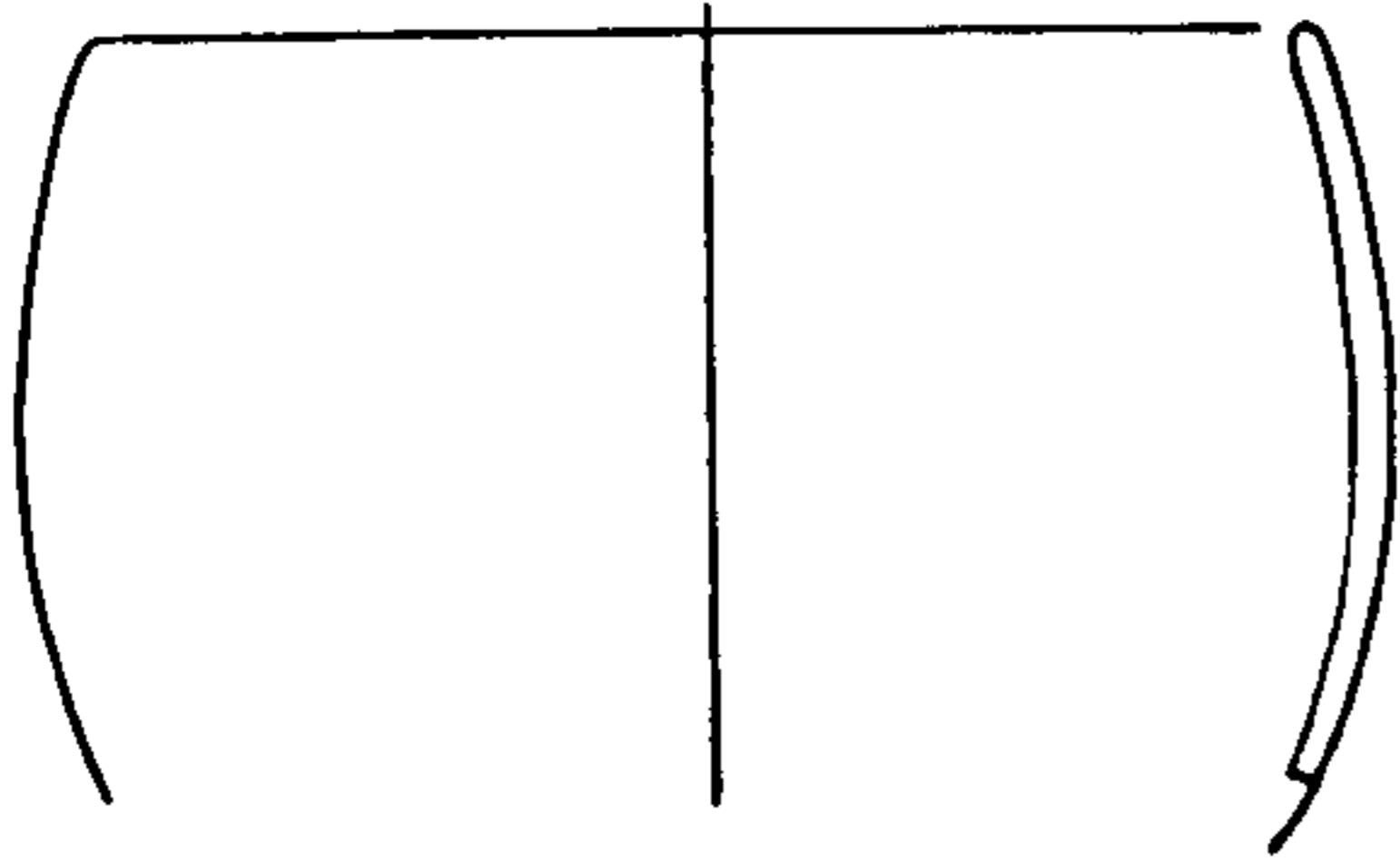

14

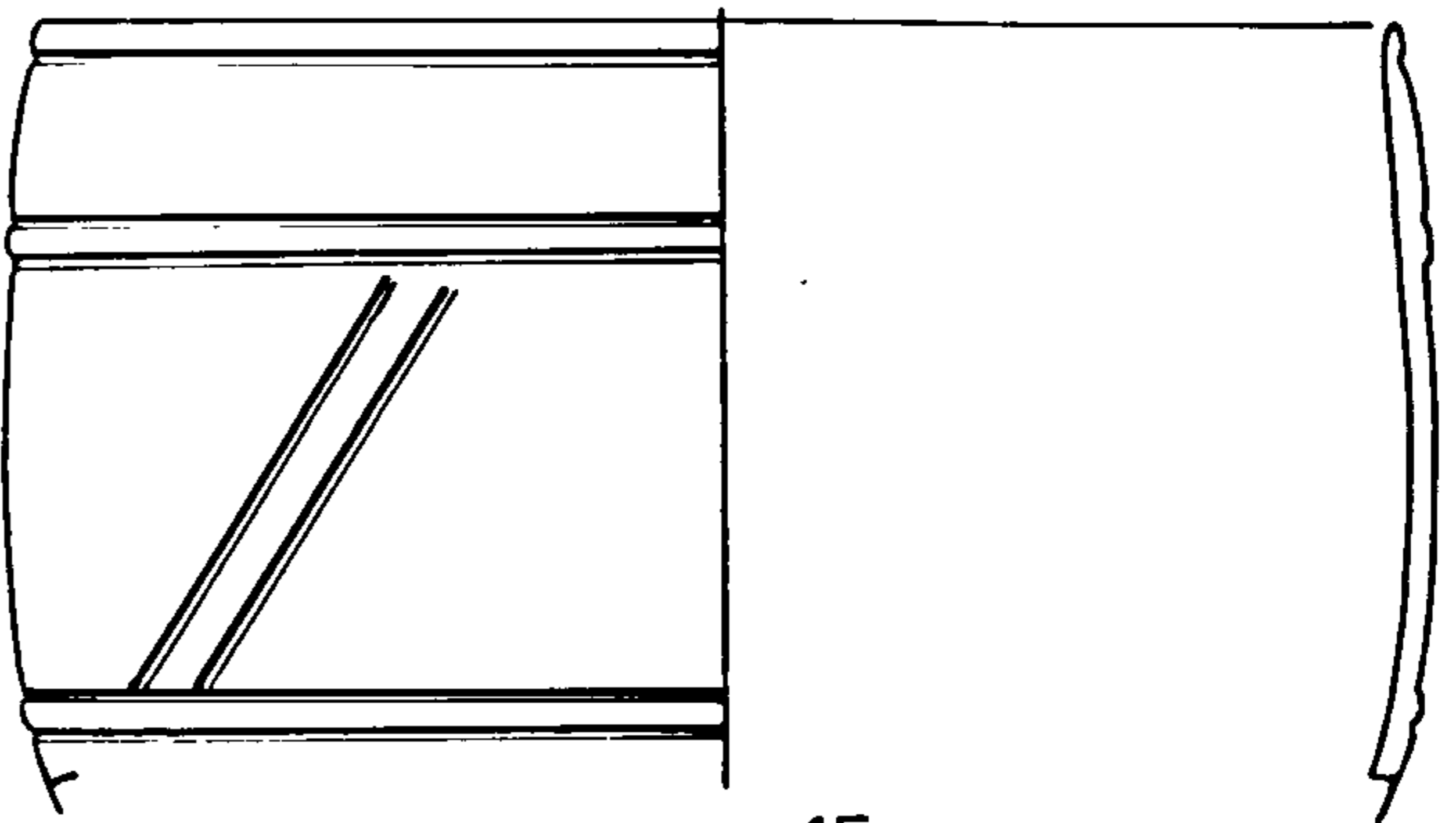

15

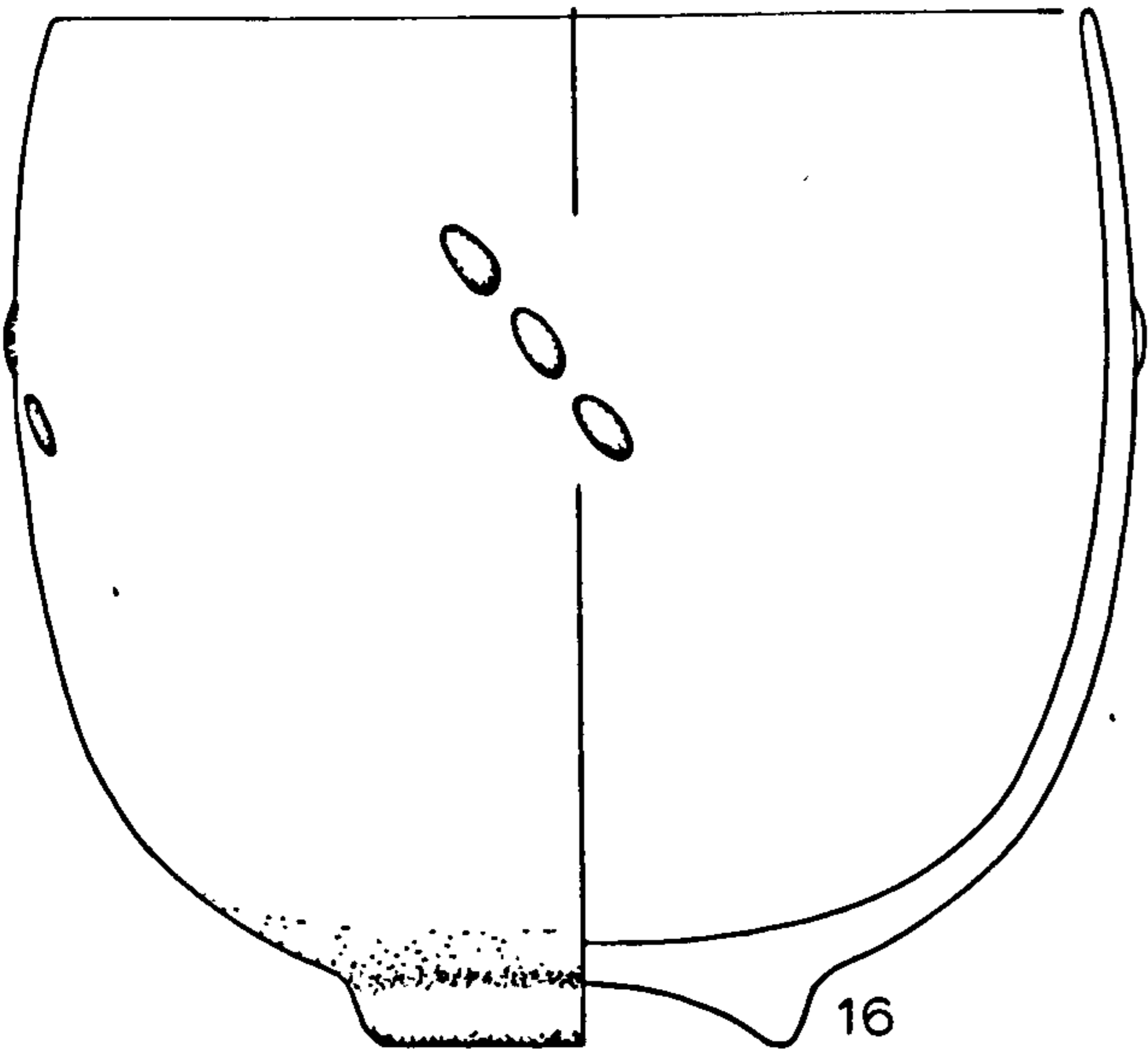

16

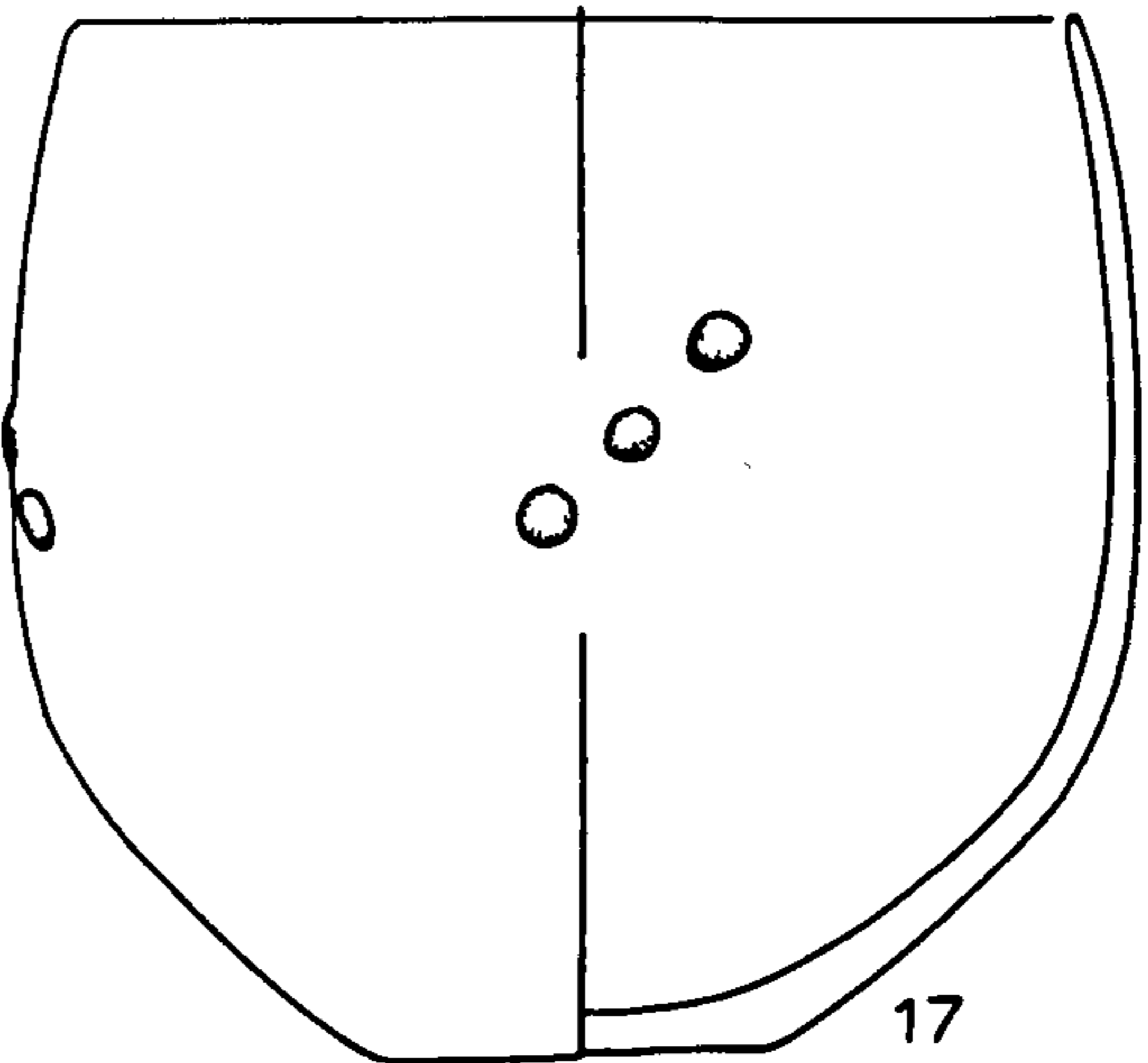

17



Fig. 3

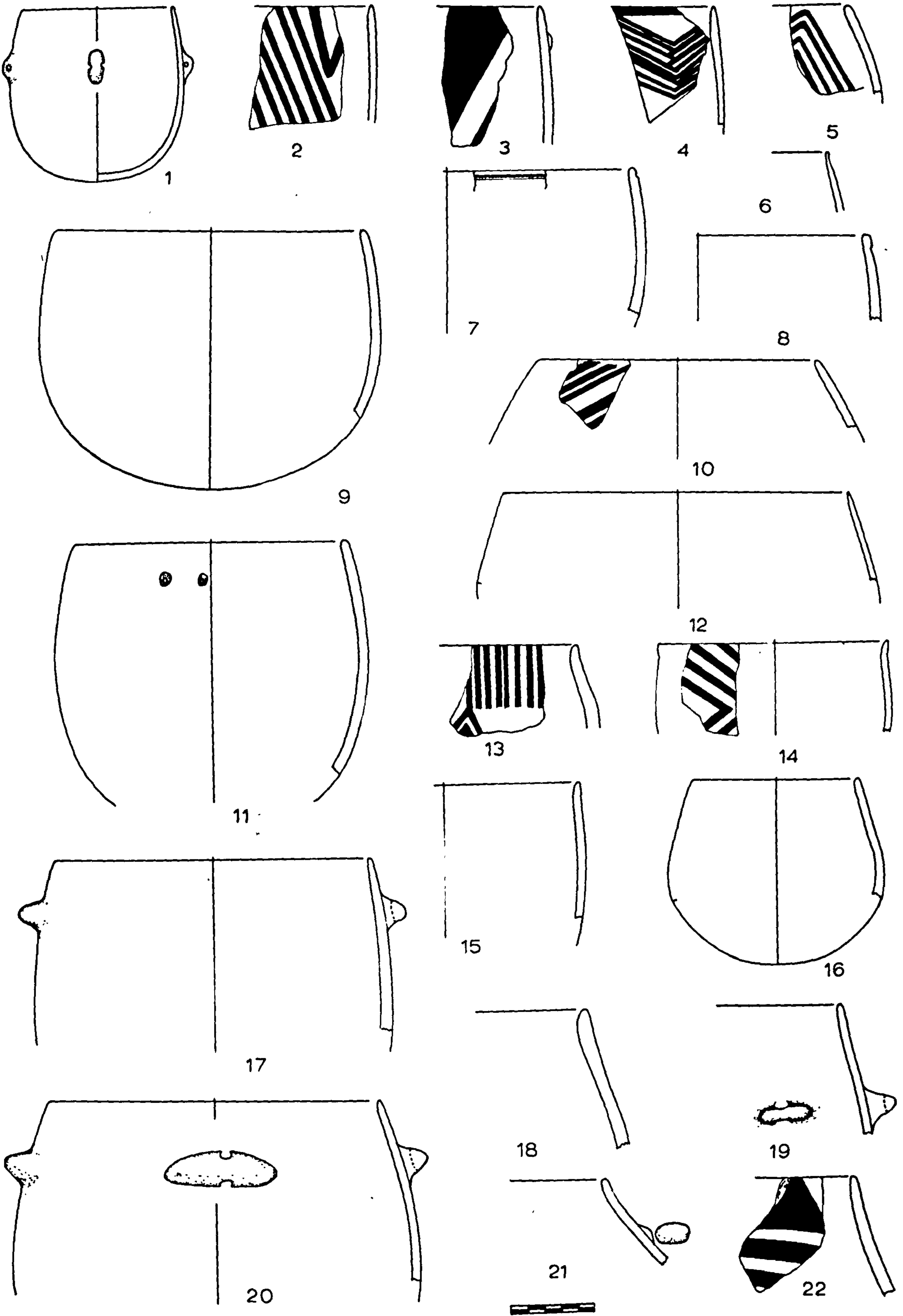

Fig. 4

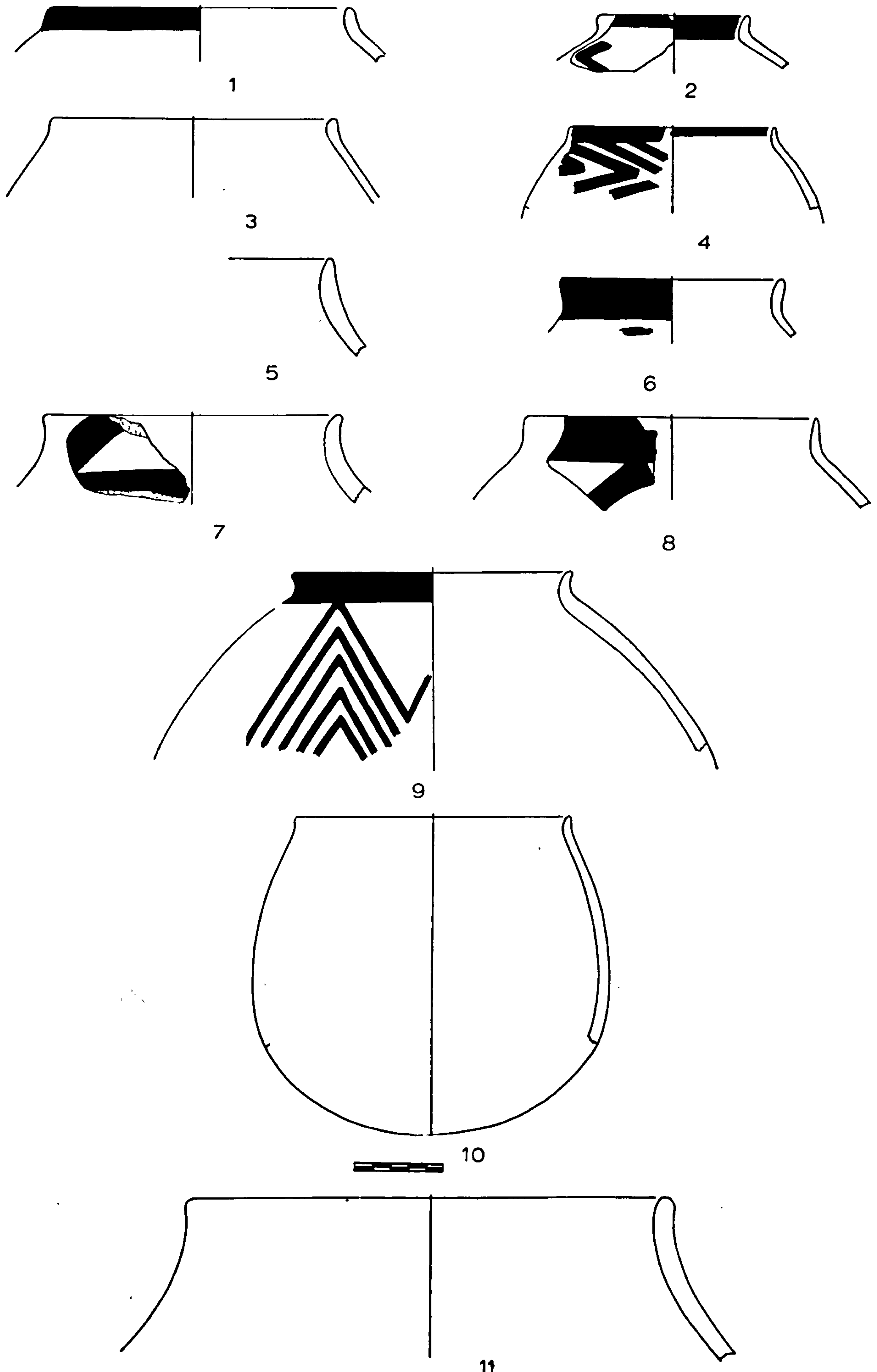

Fig. 5

© 1975 by the American Museum of Natural History

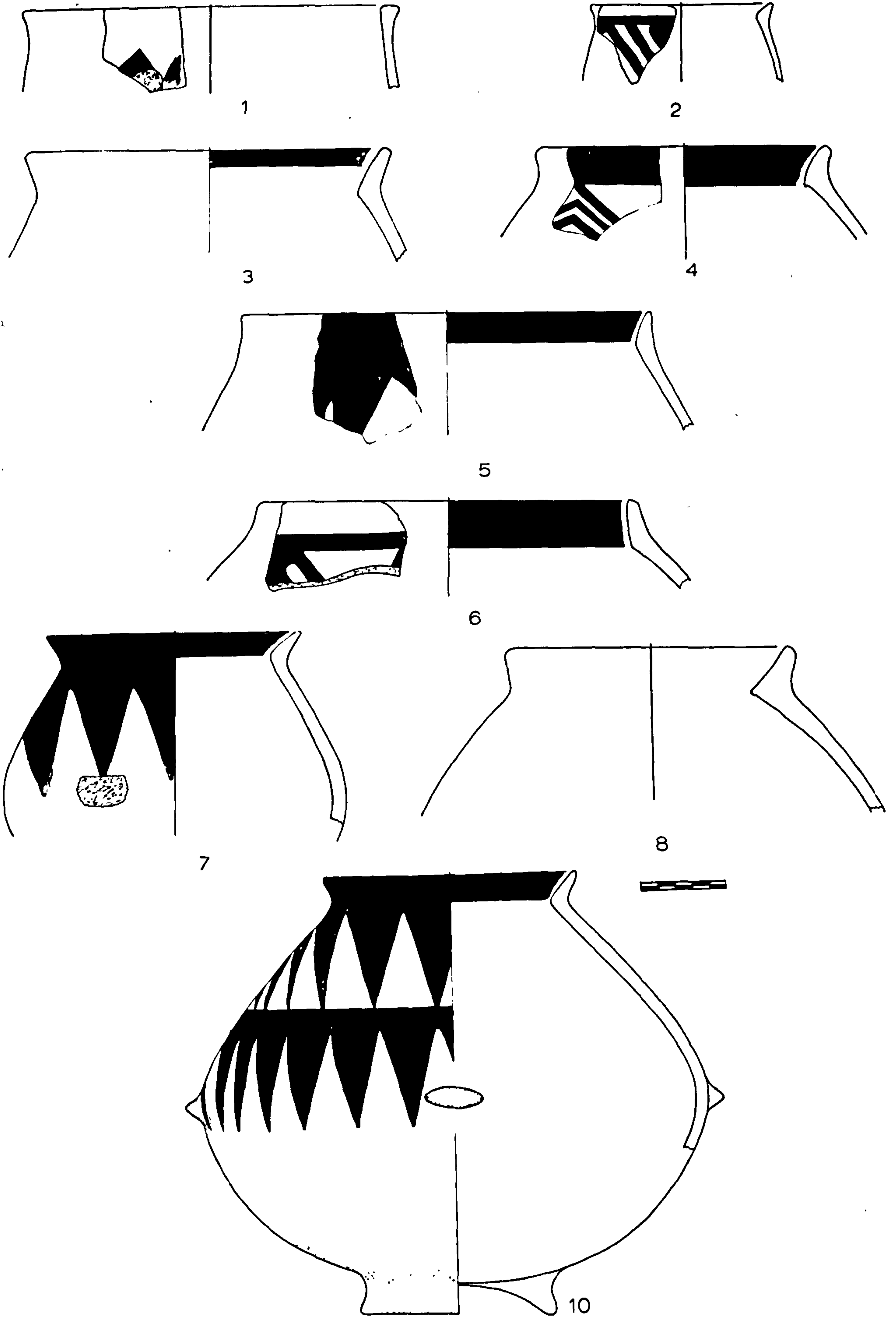

Fig. 6

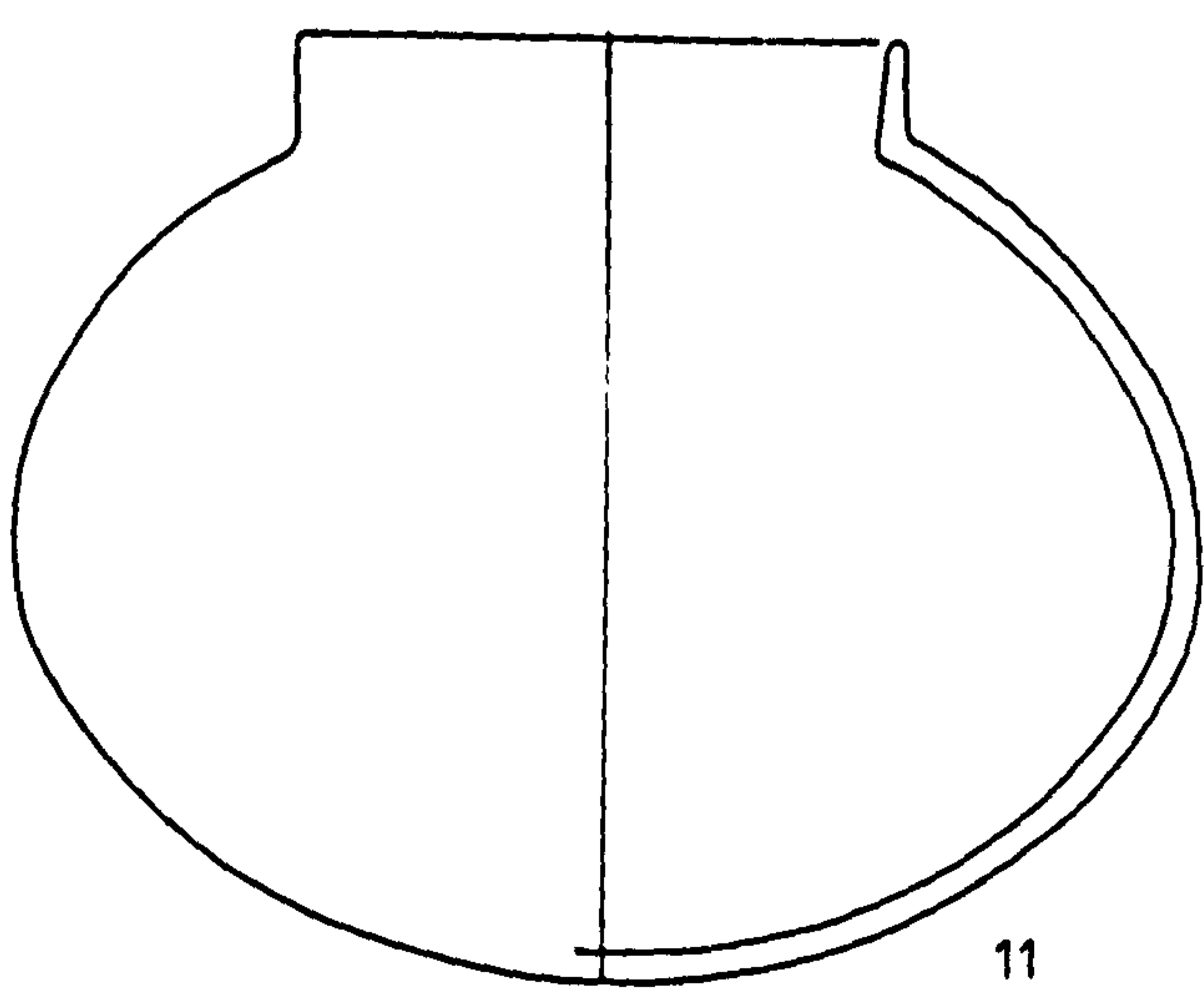
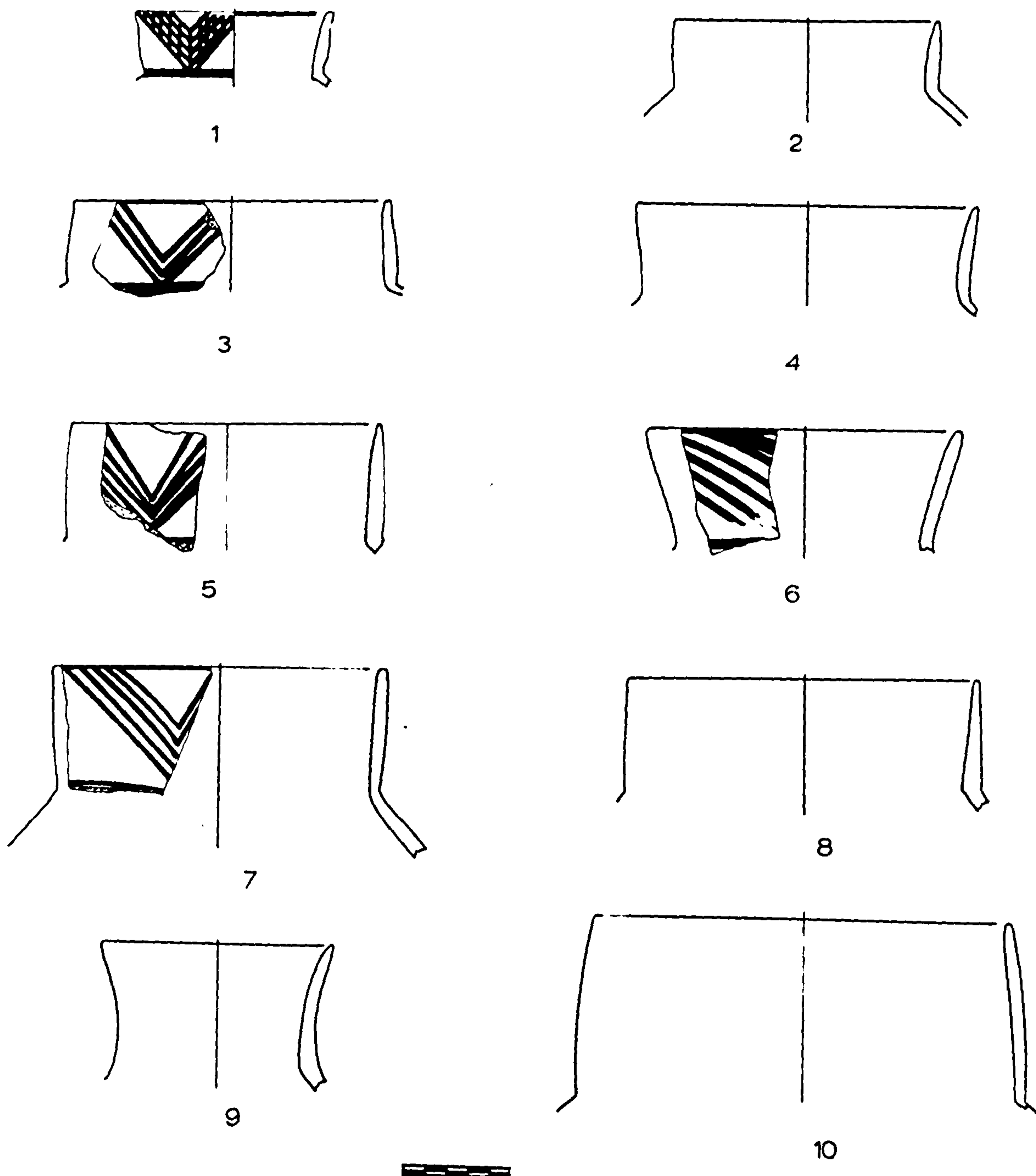

Fig. 7

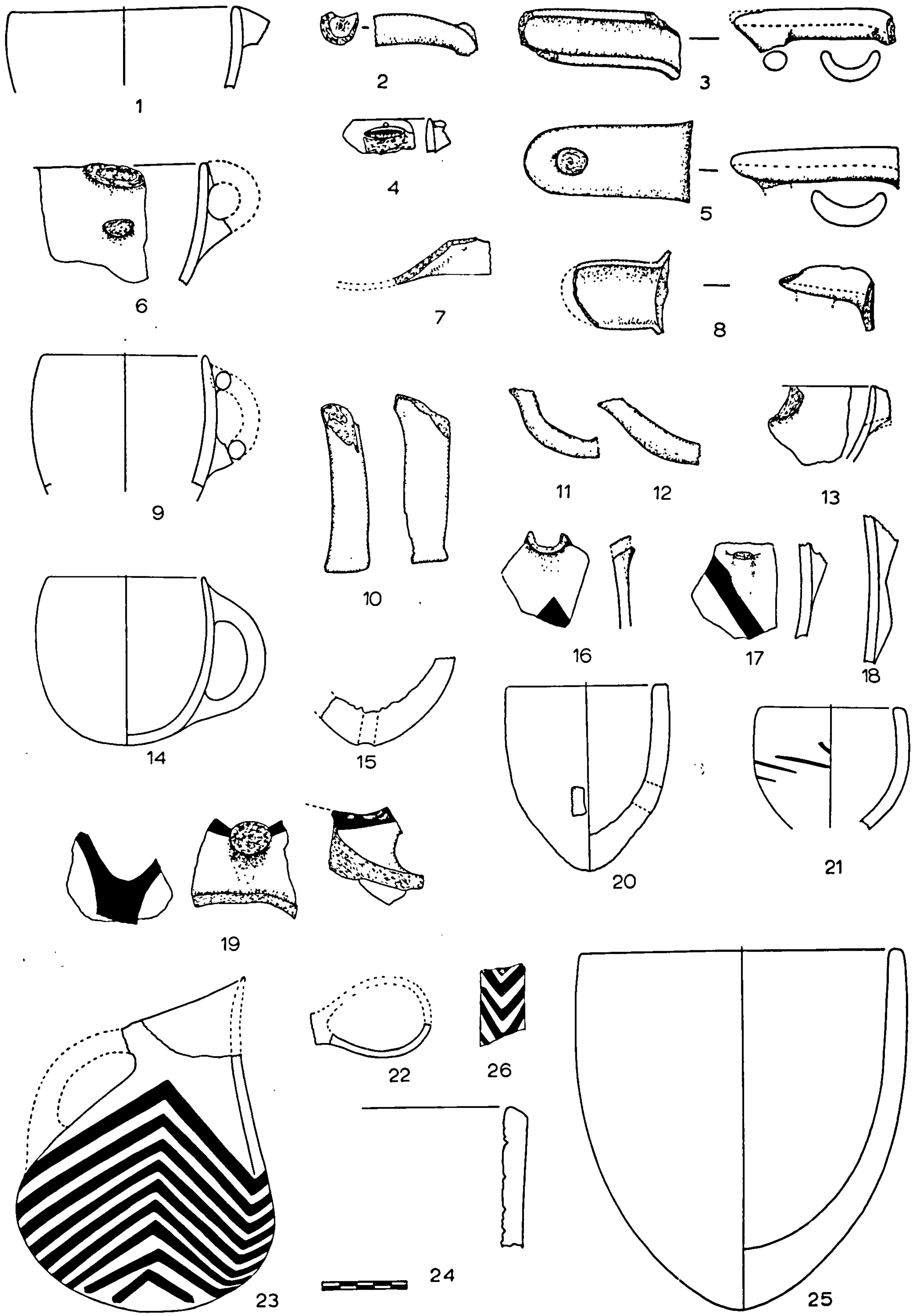

Fig. 8

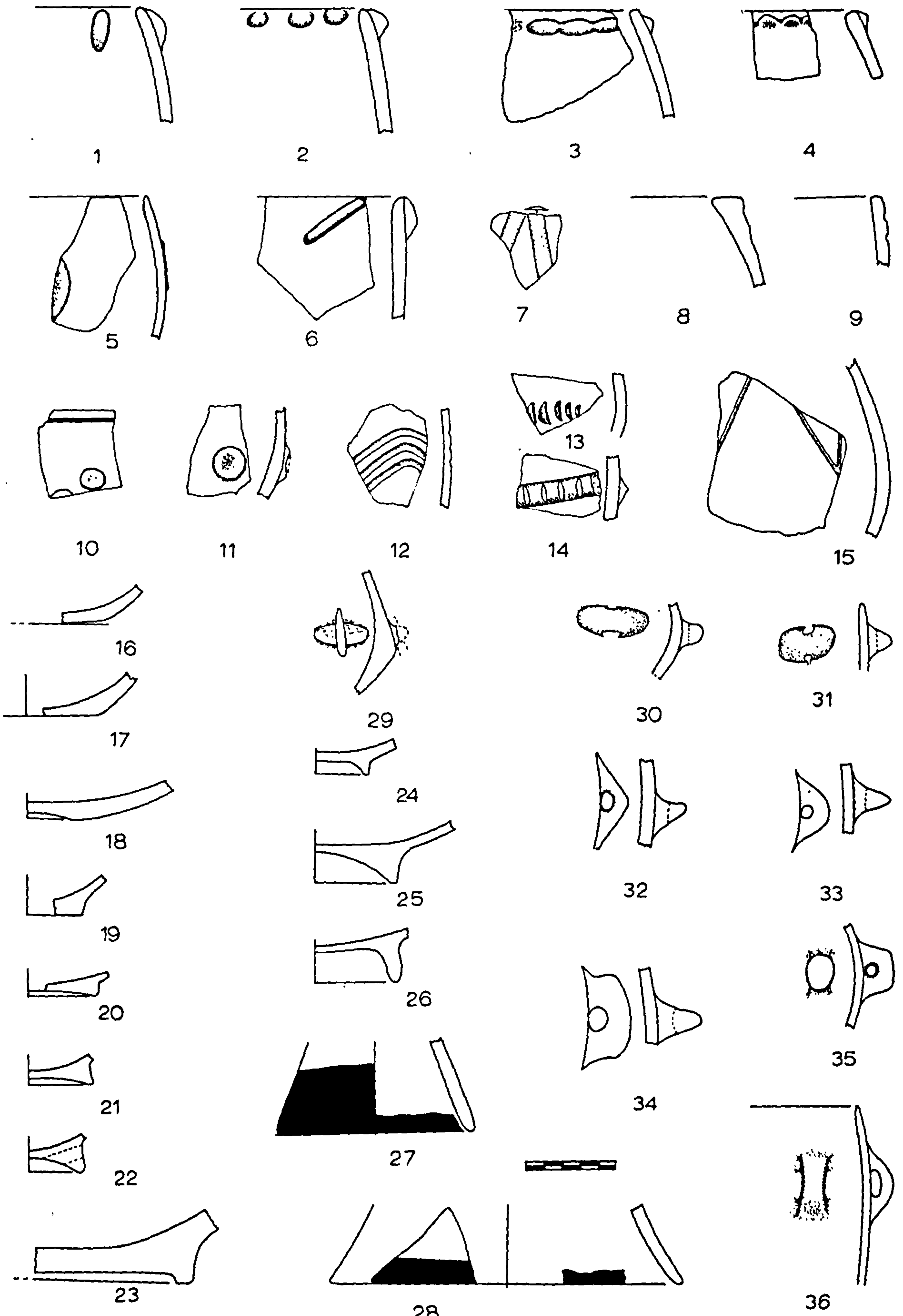

Fig. 9

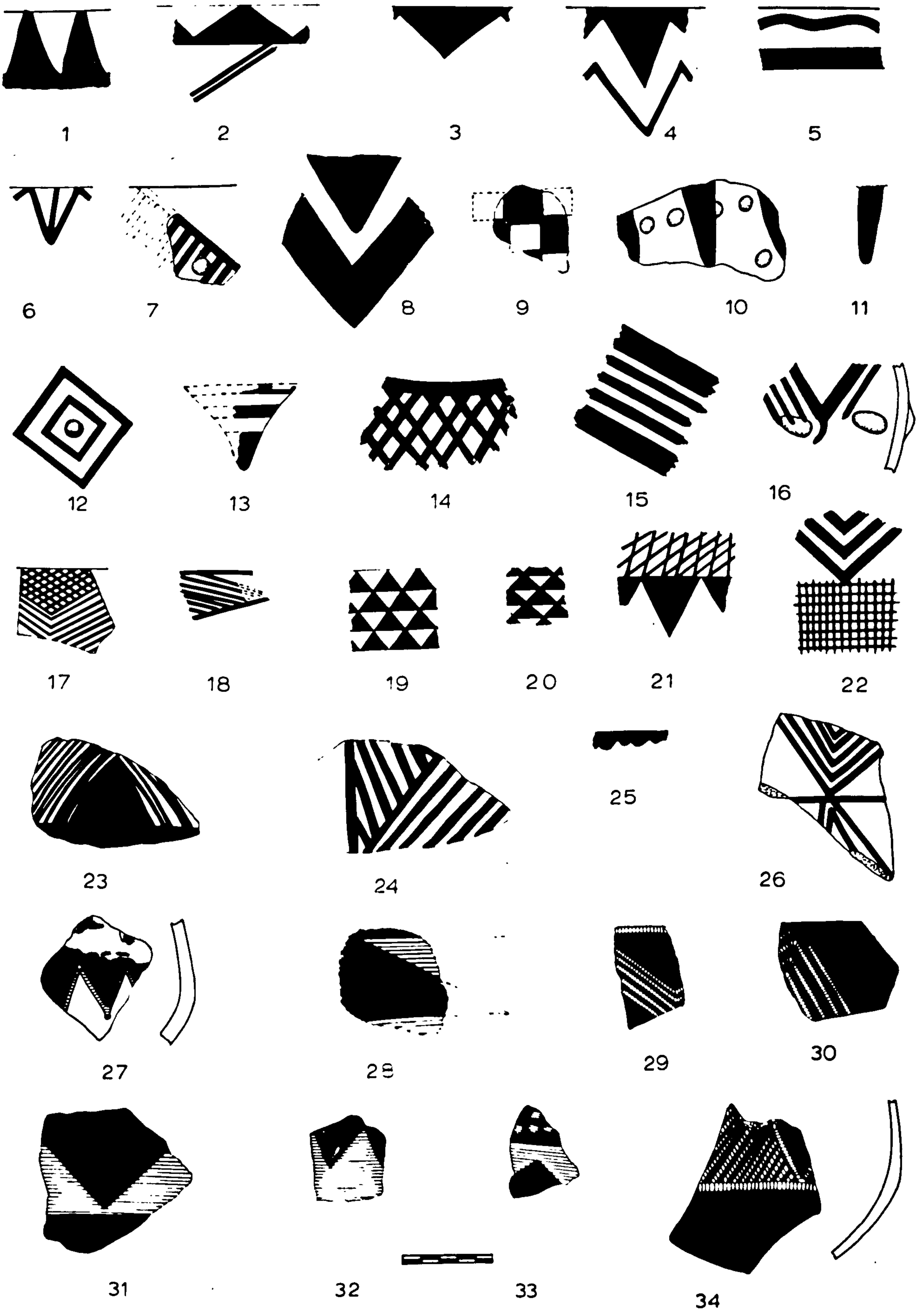

Fig.10

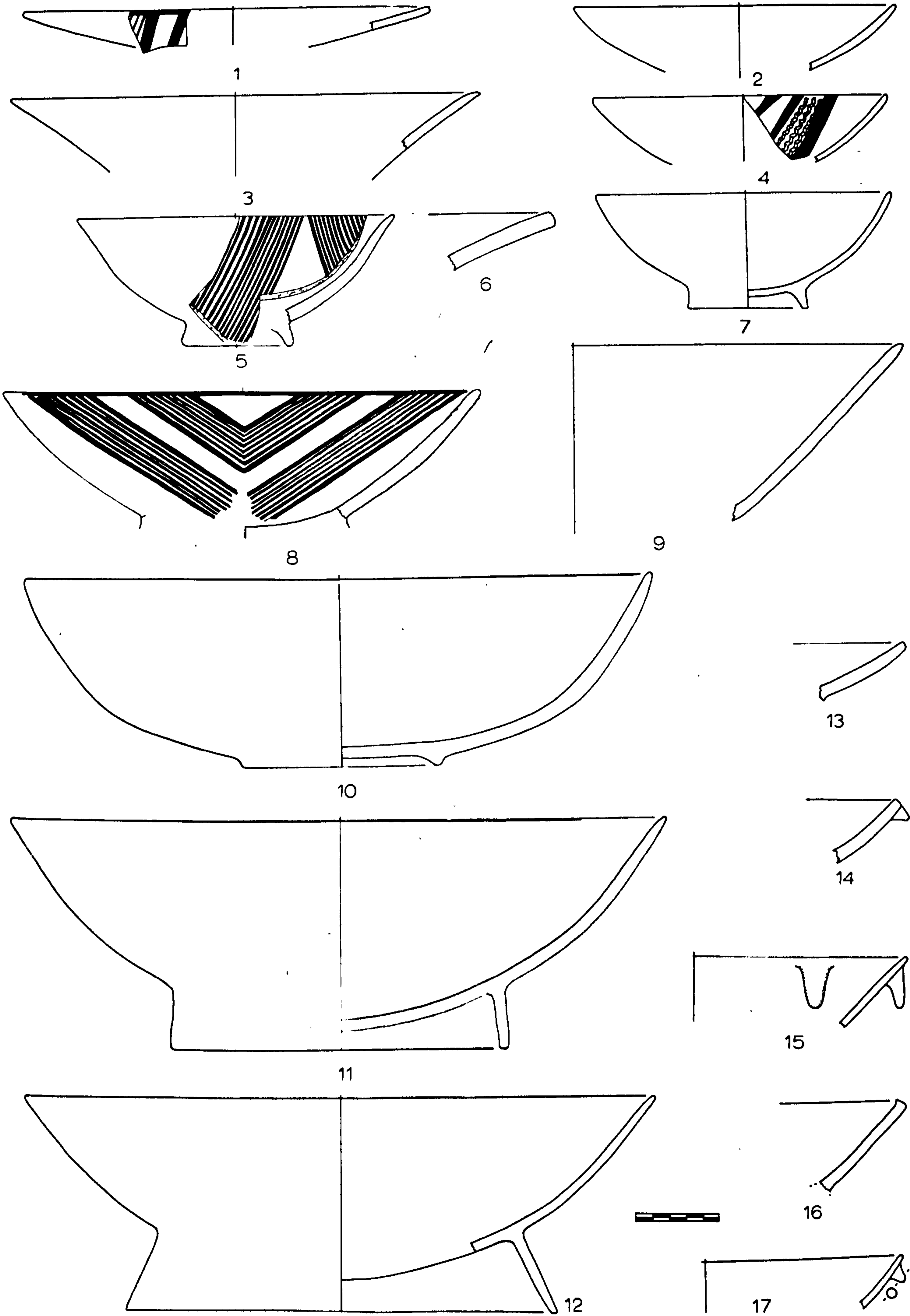

Fig 11

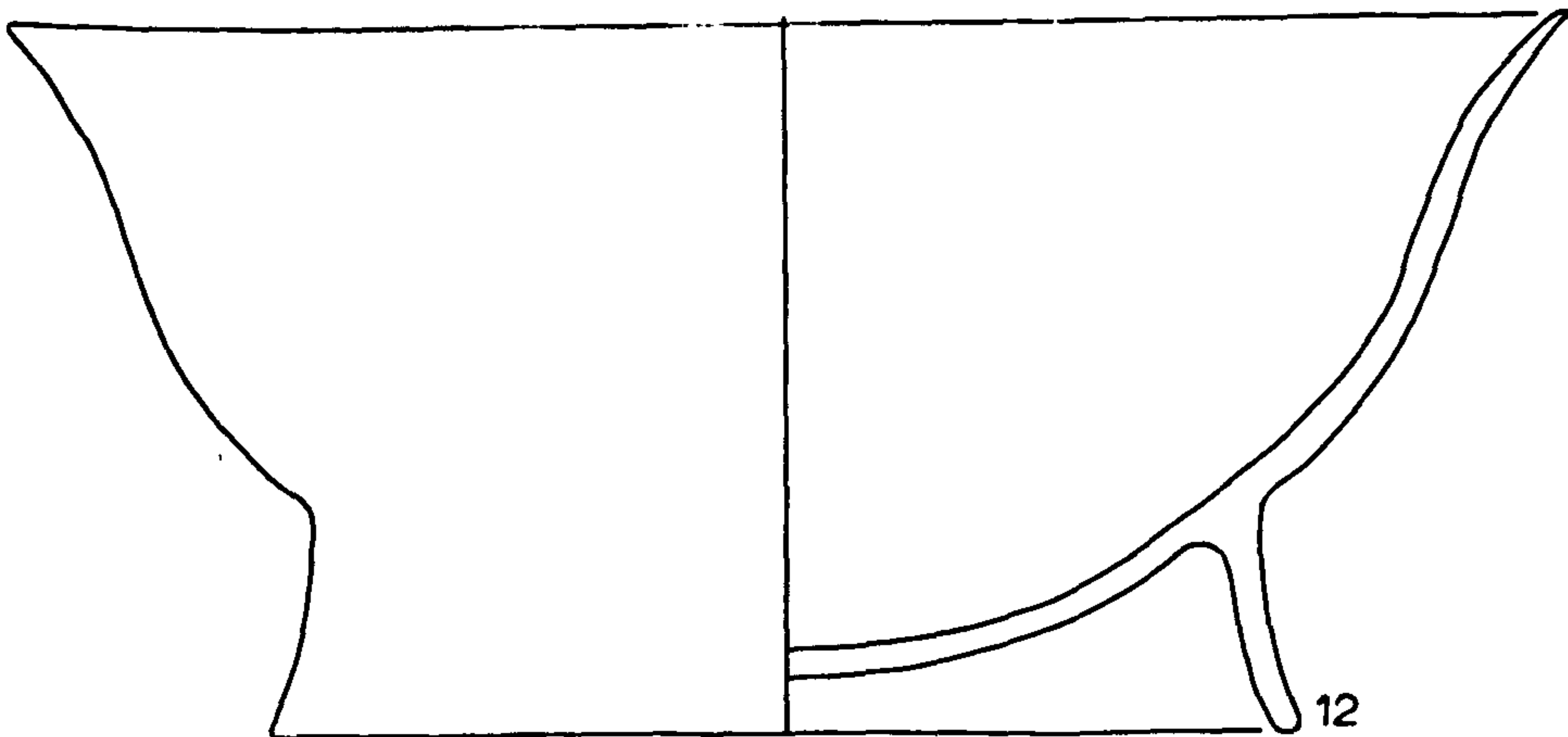
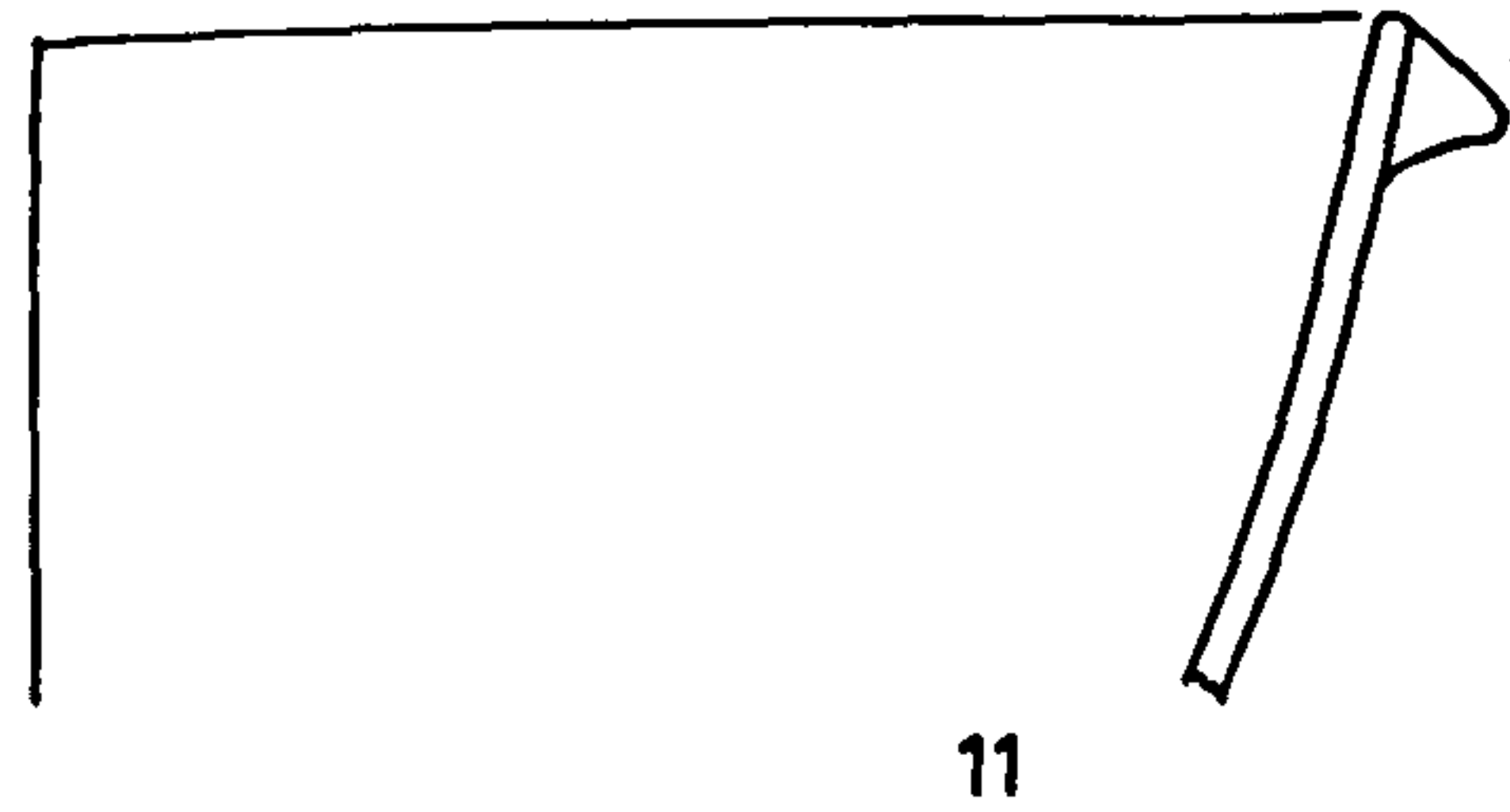
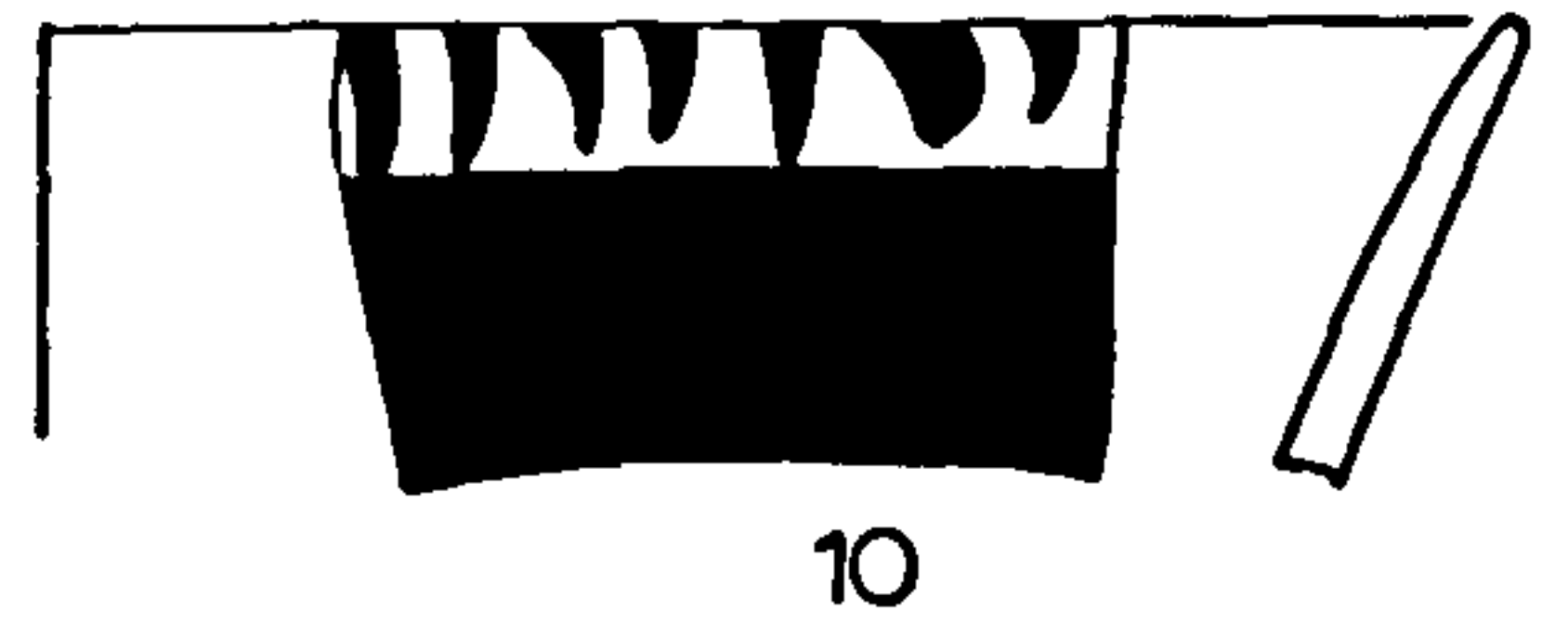
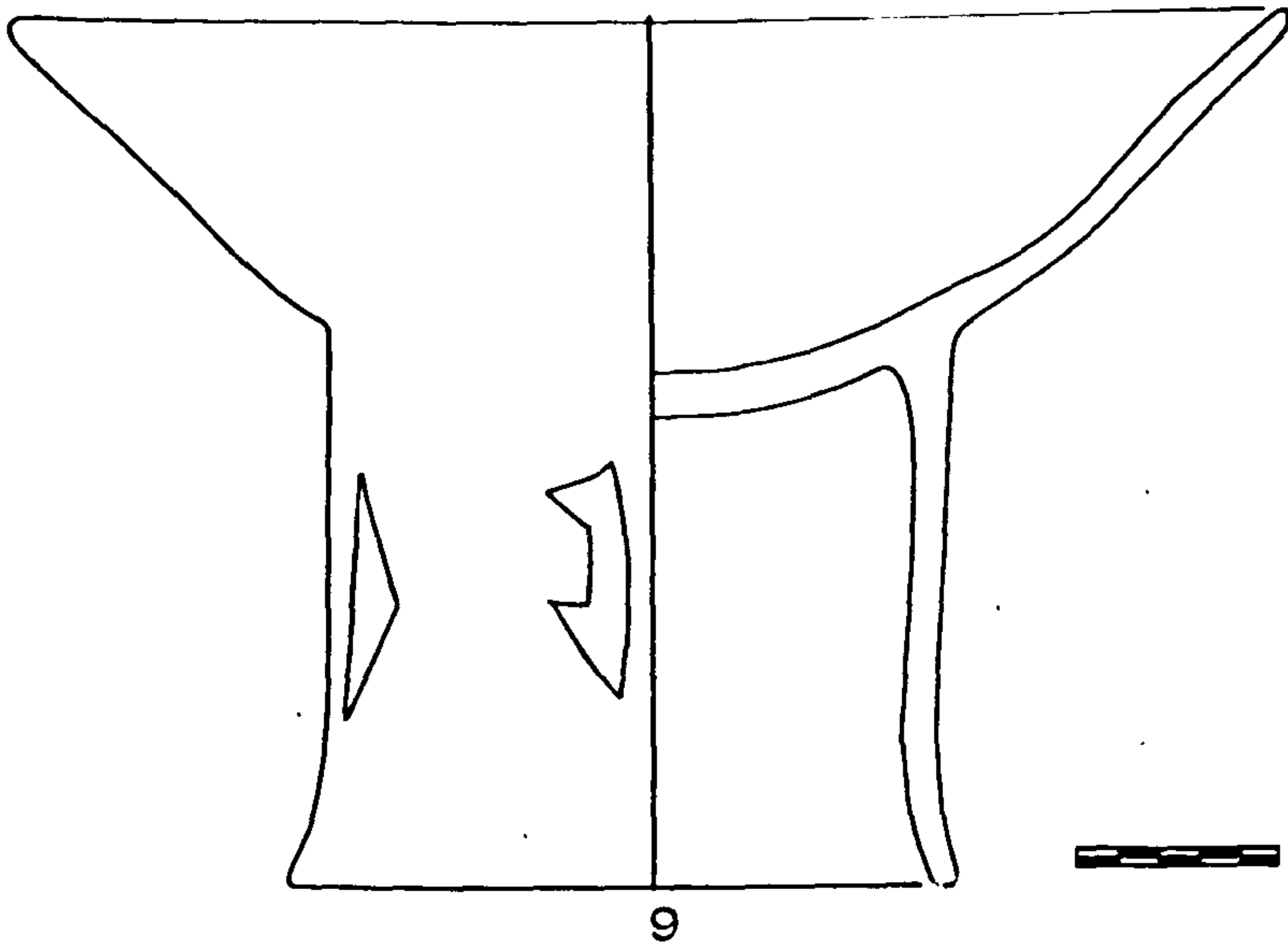
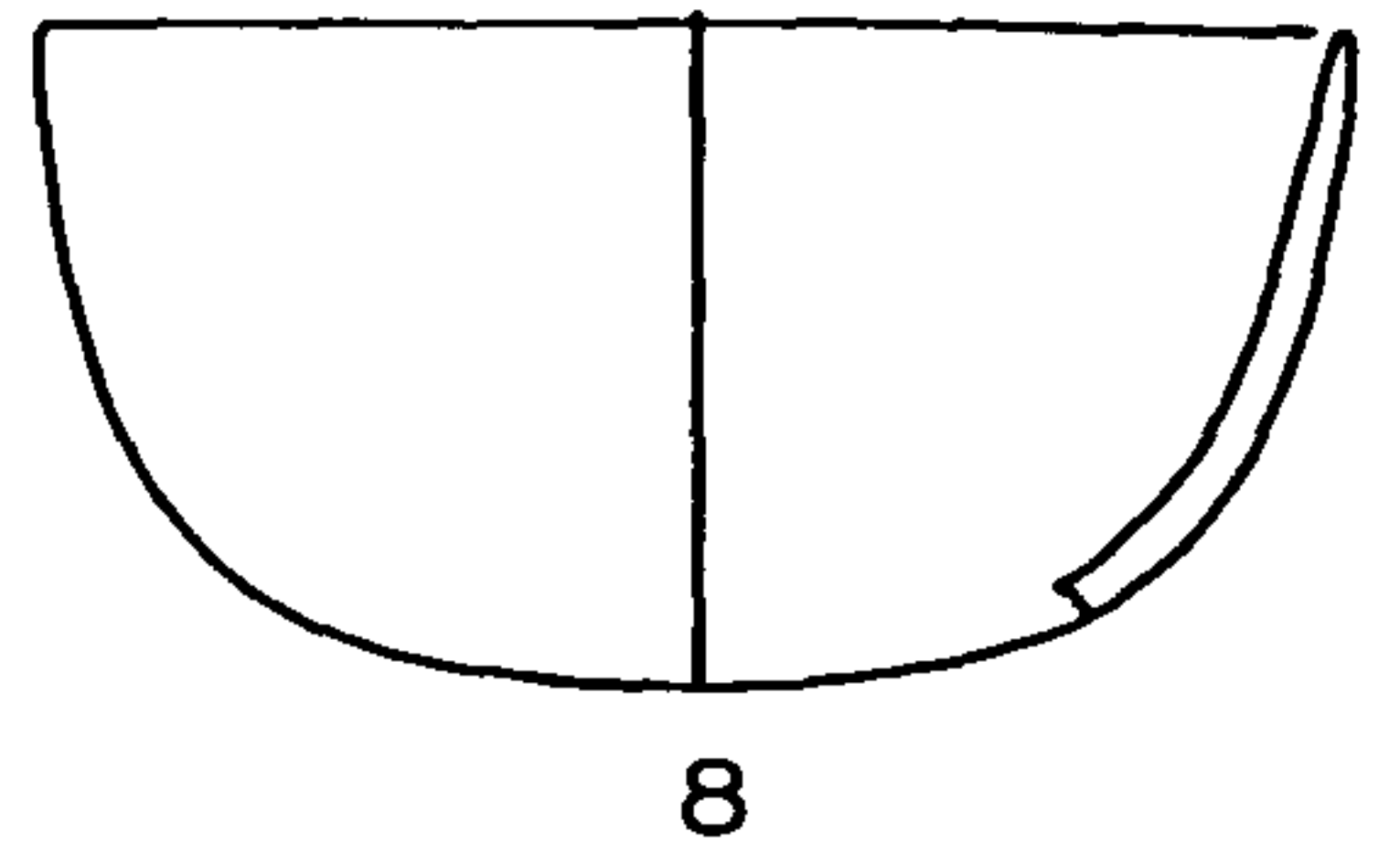
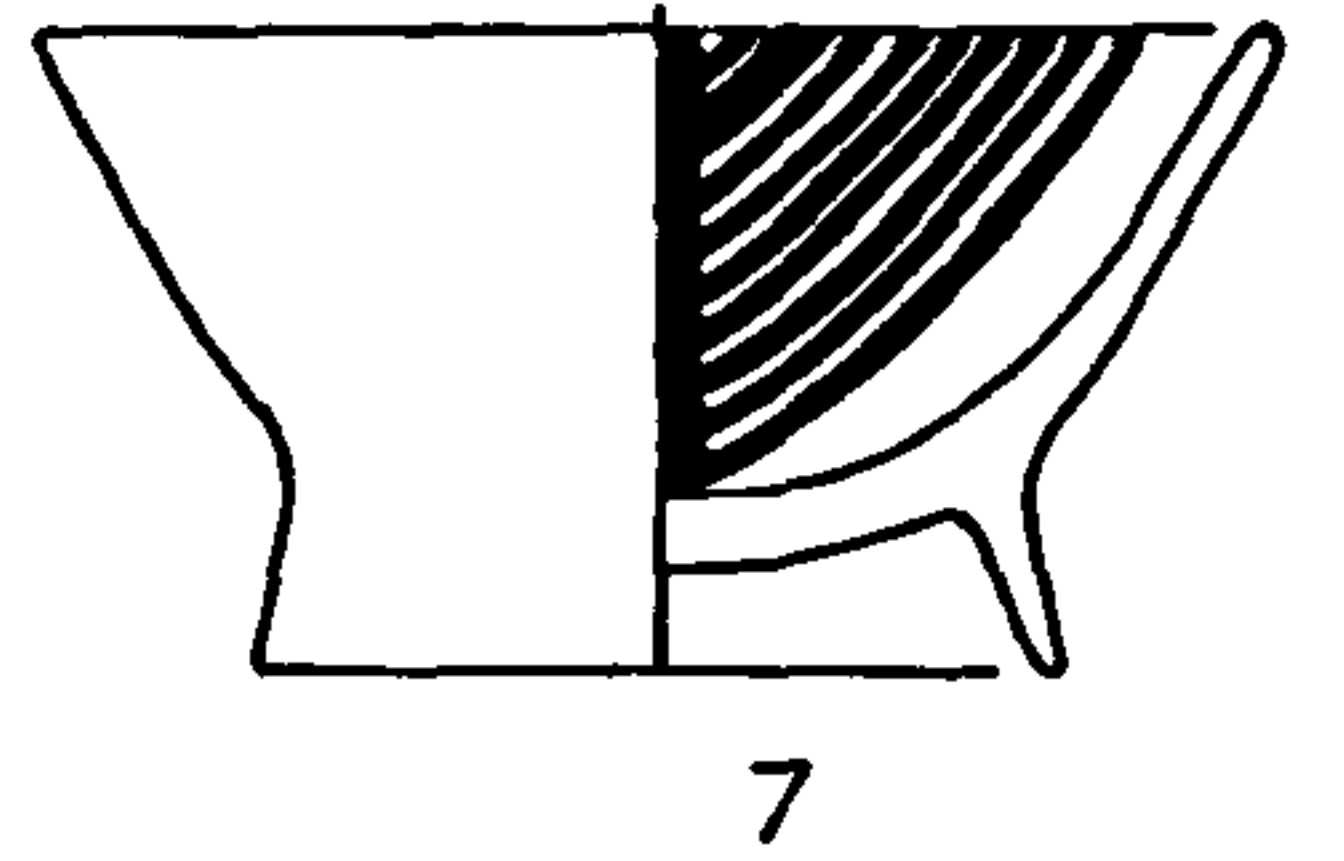
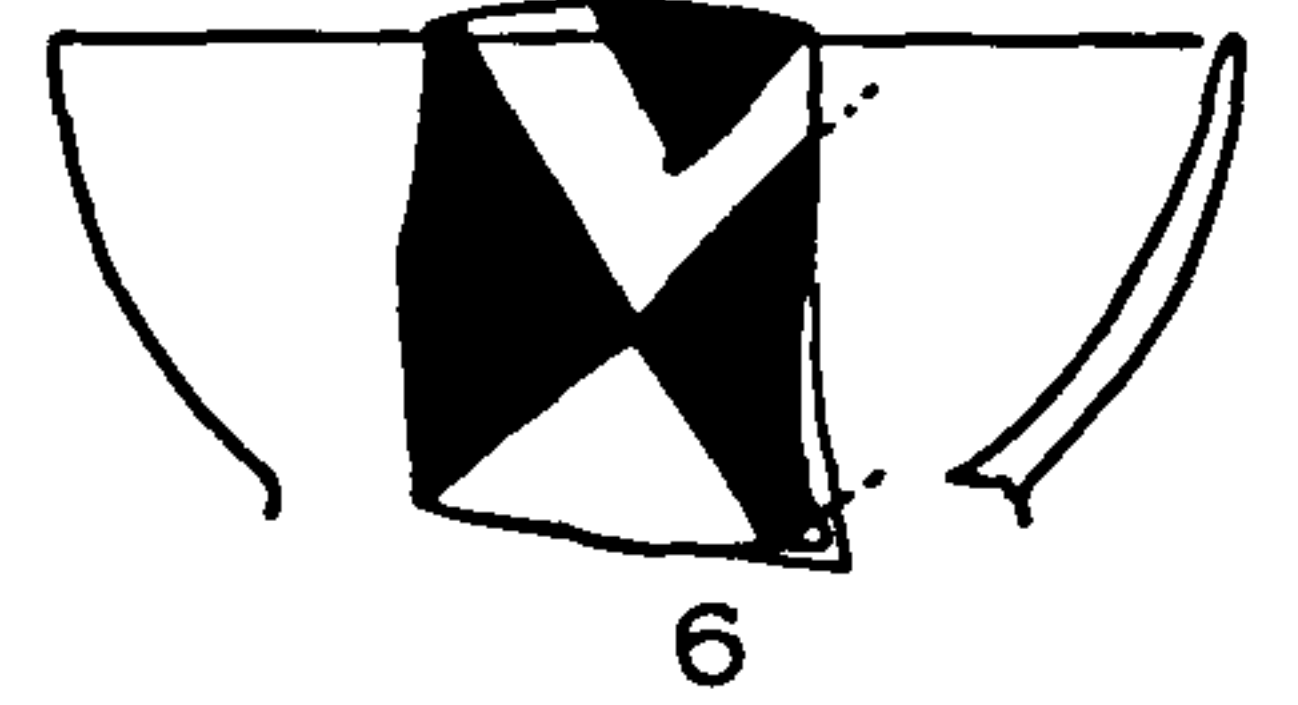
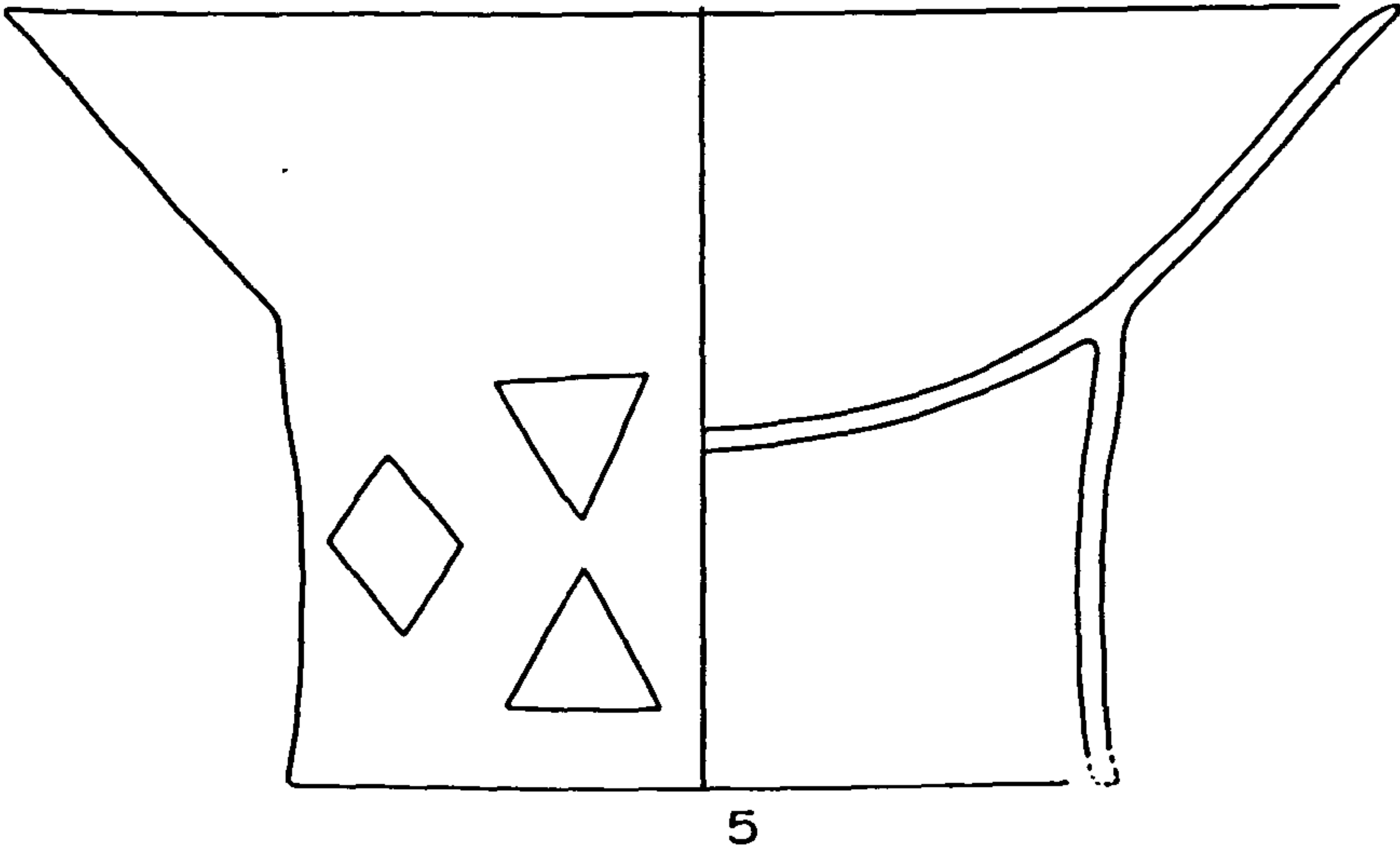
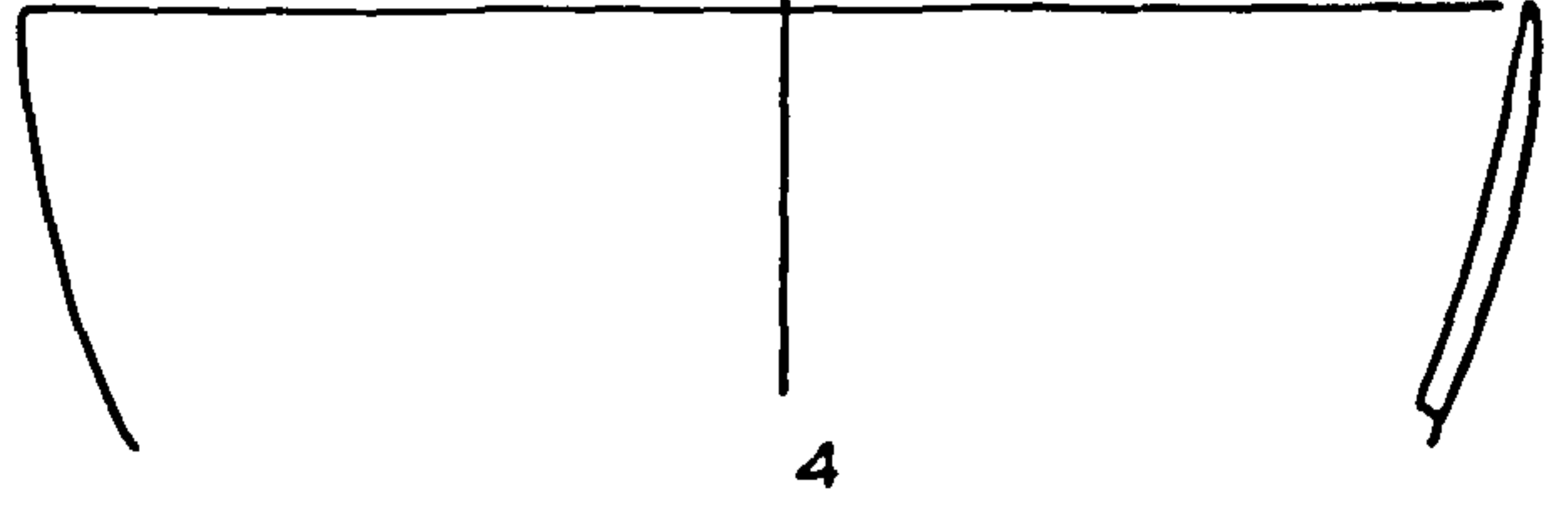
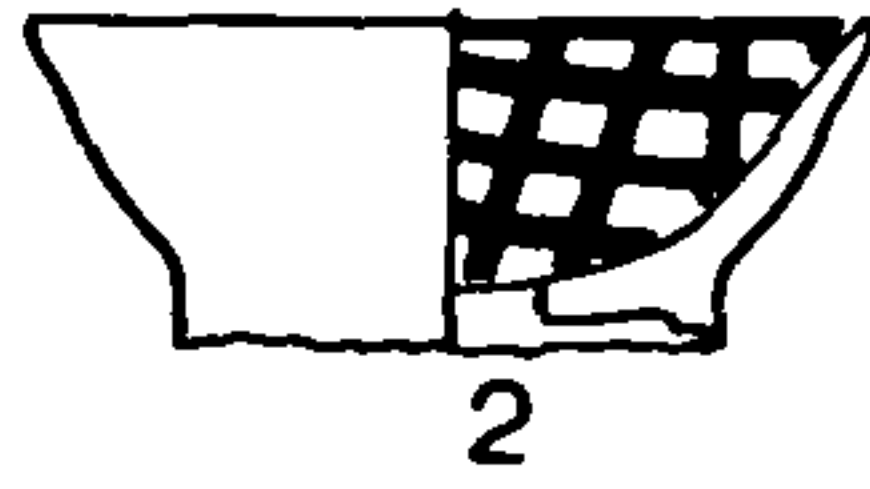
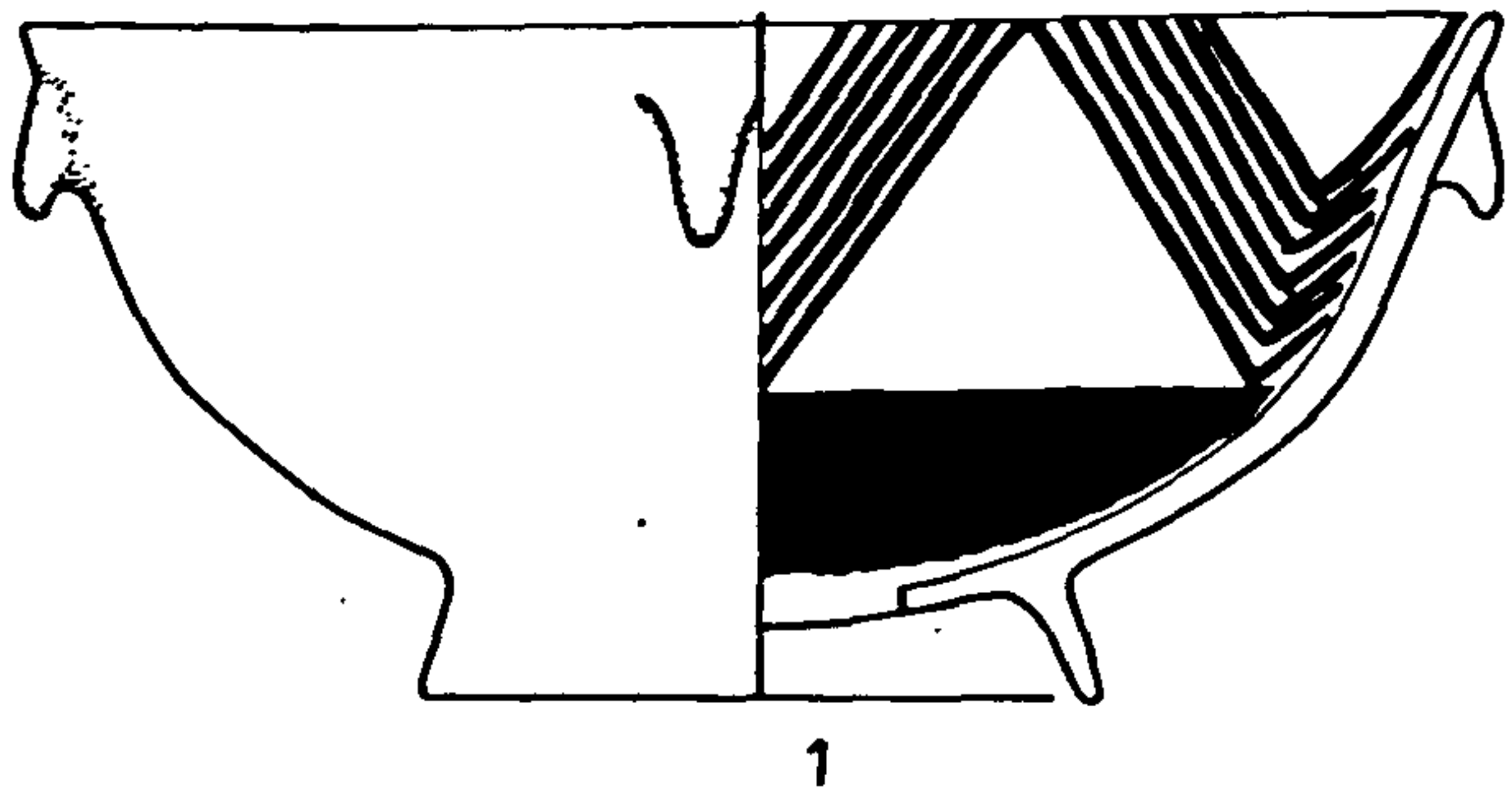

Fig.12

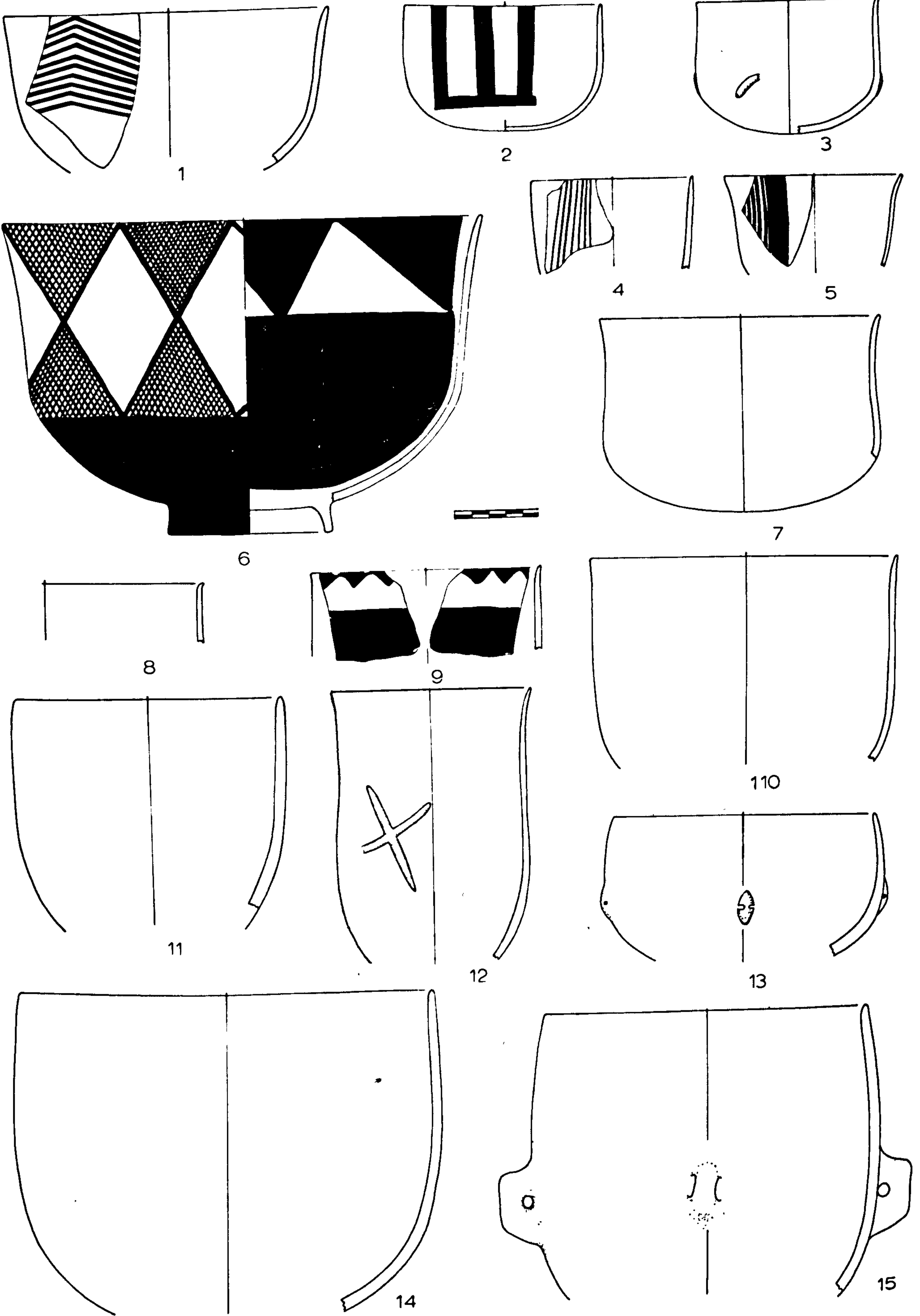

Fig. 13

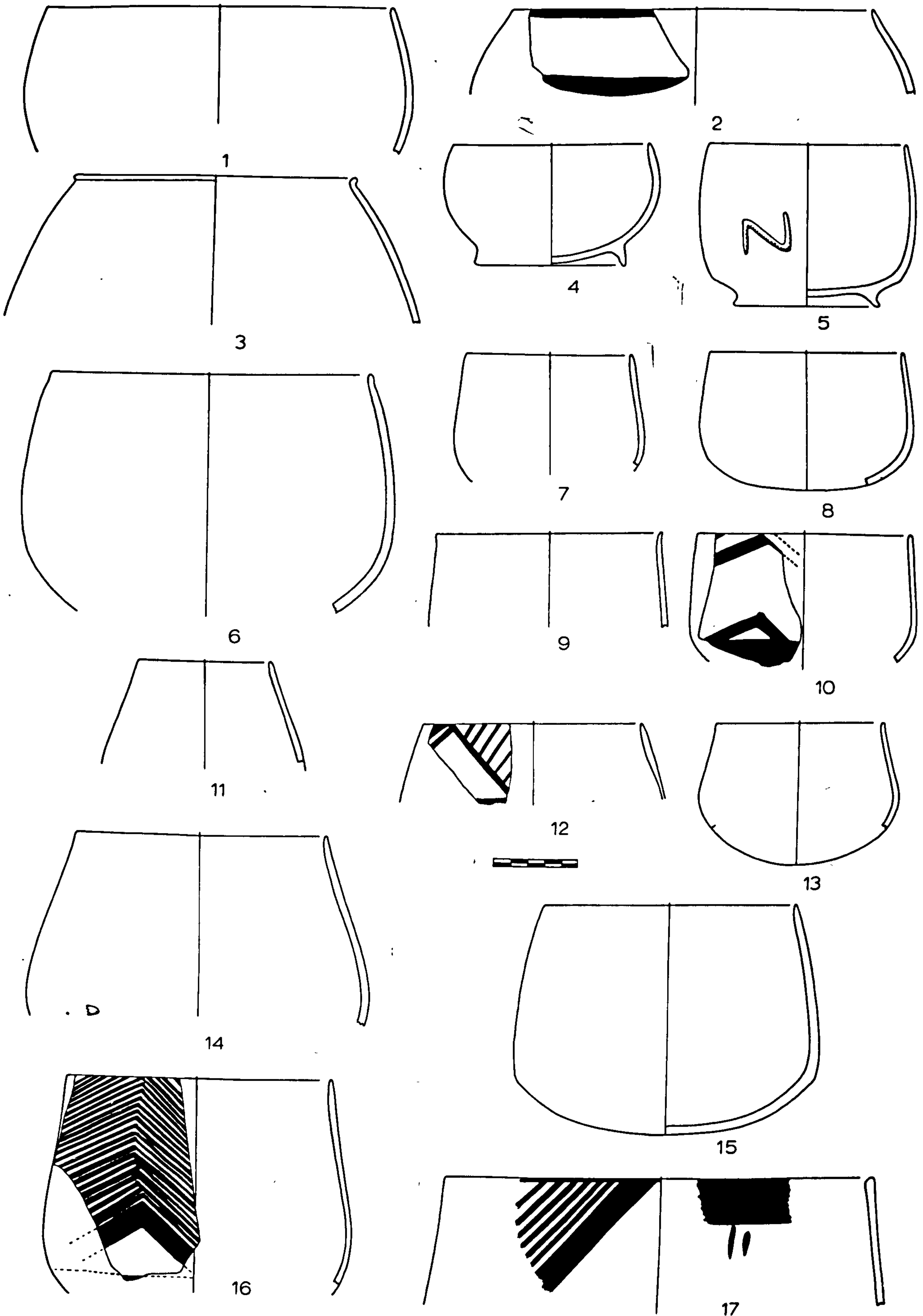

Fig 14

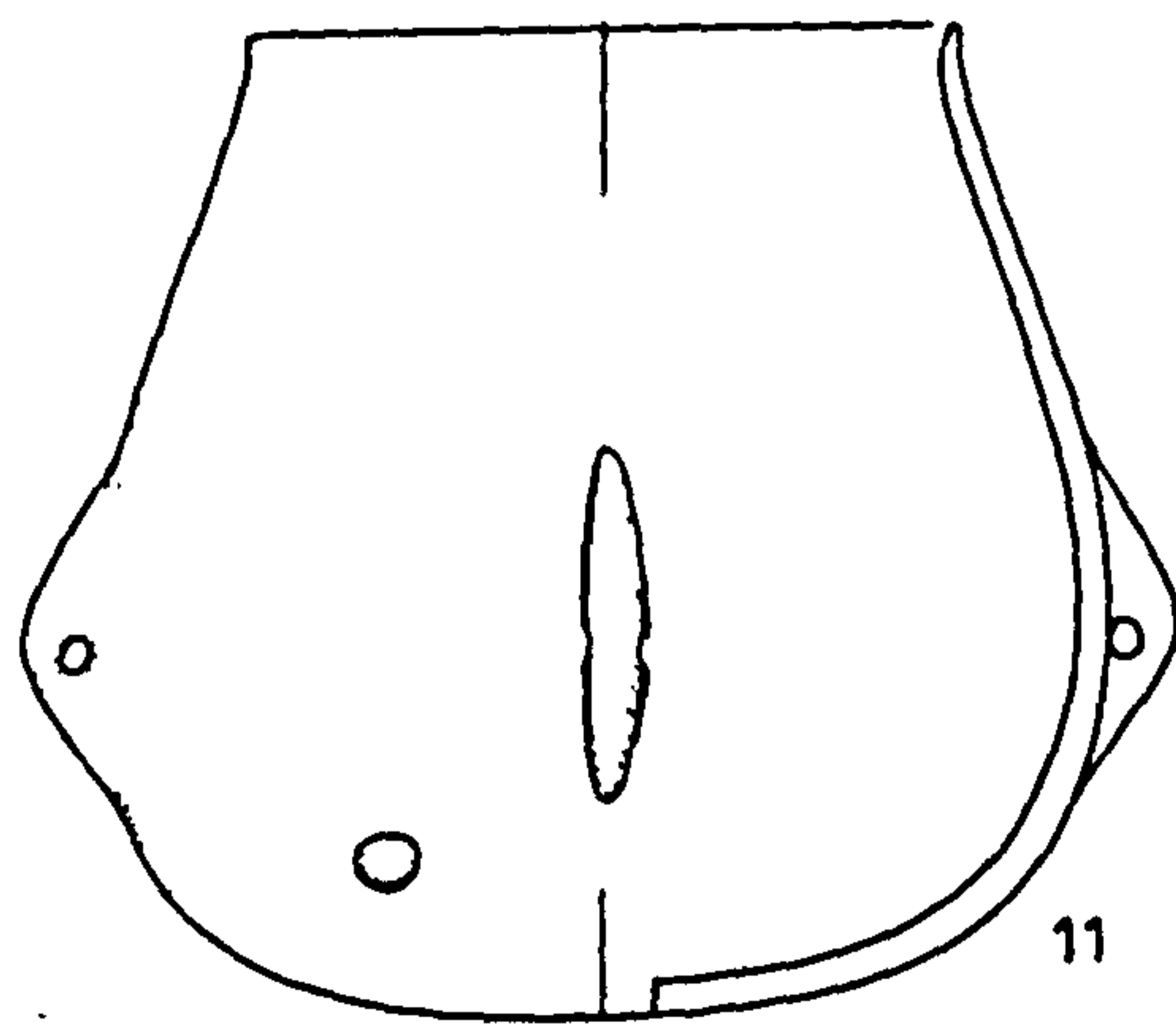
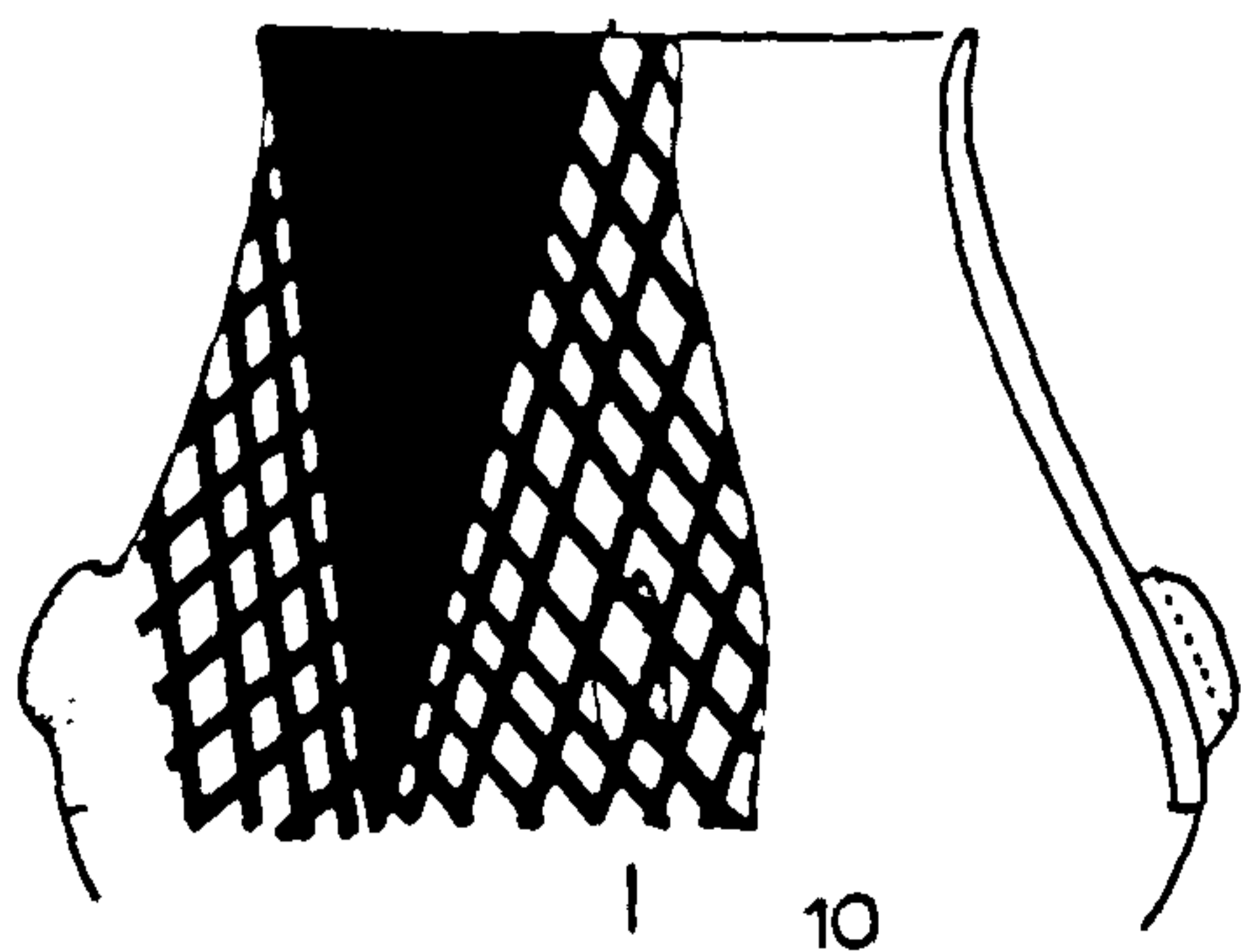
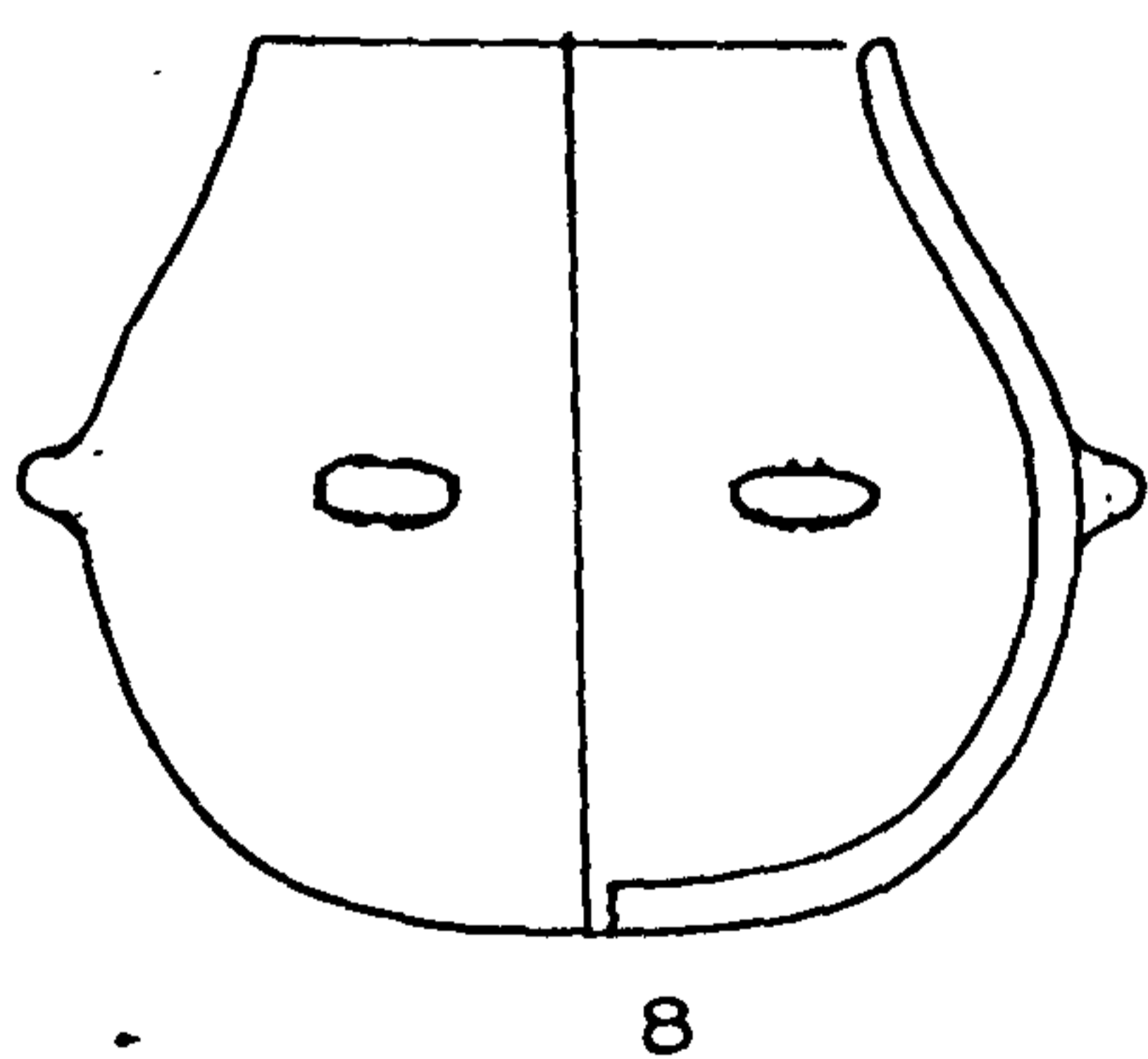
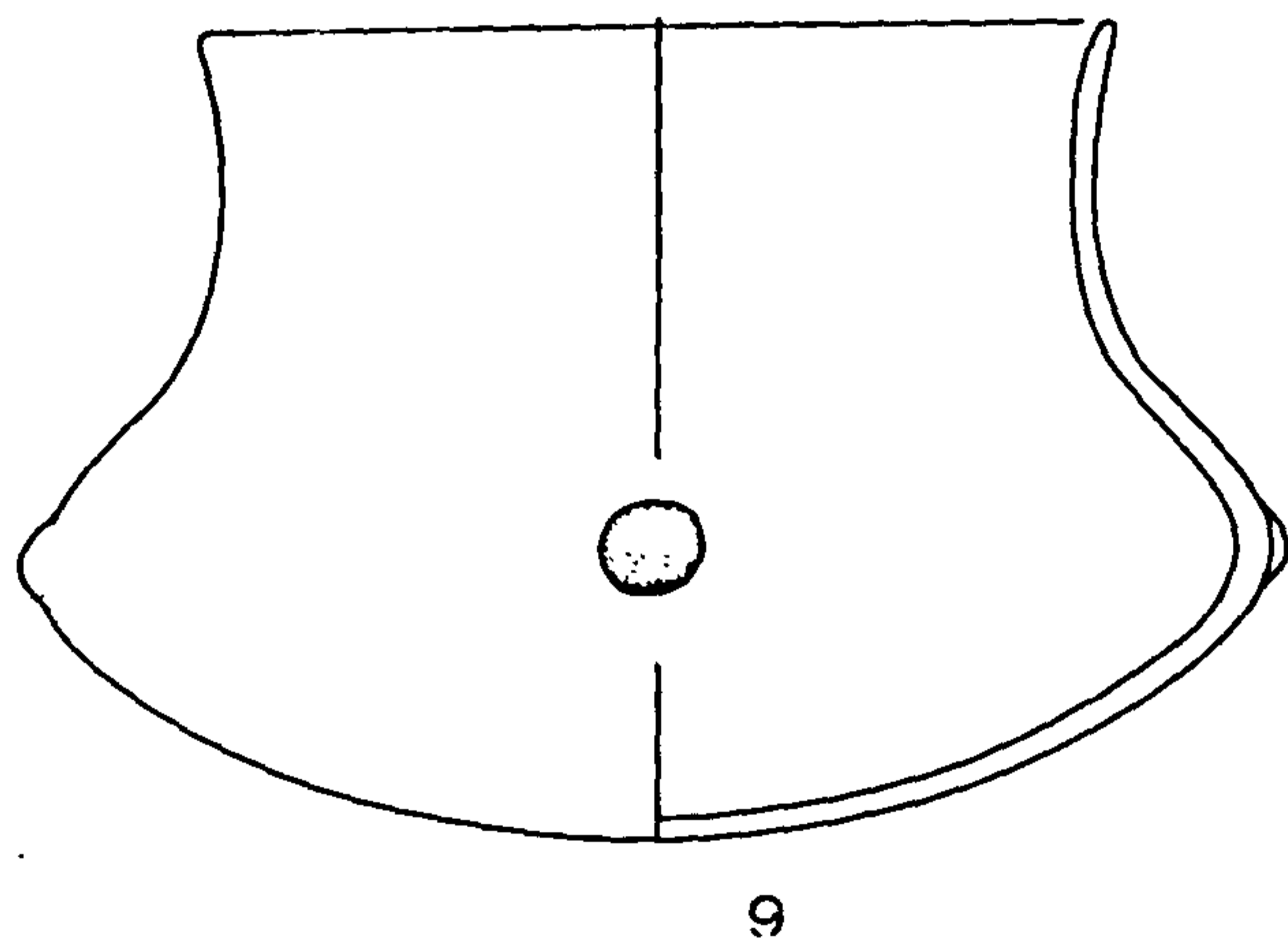
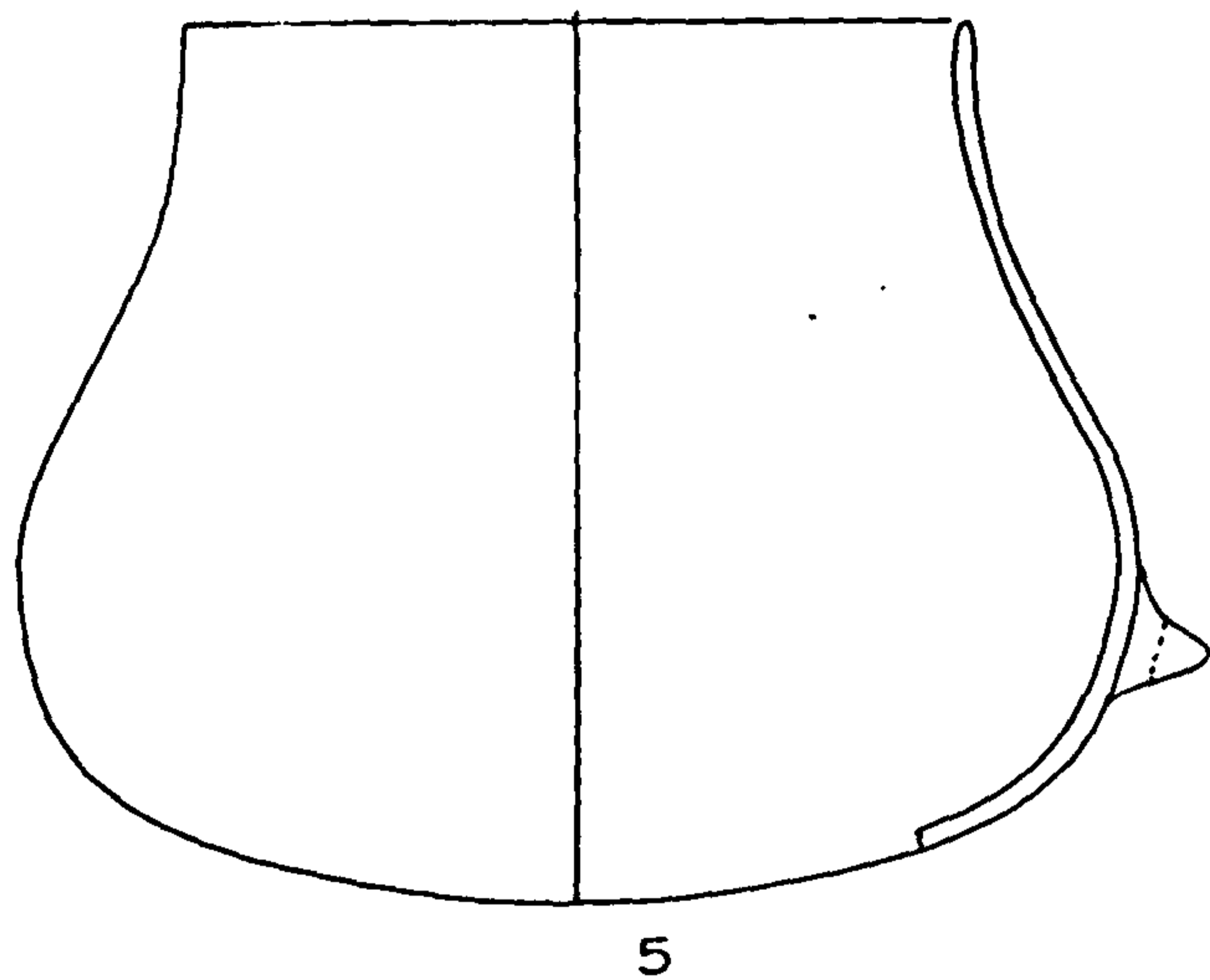
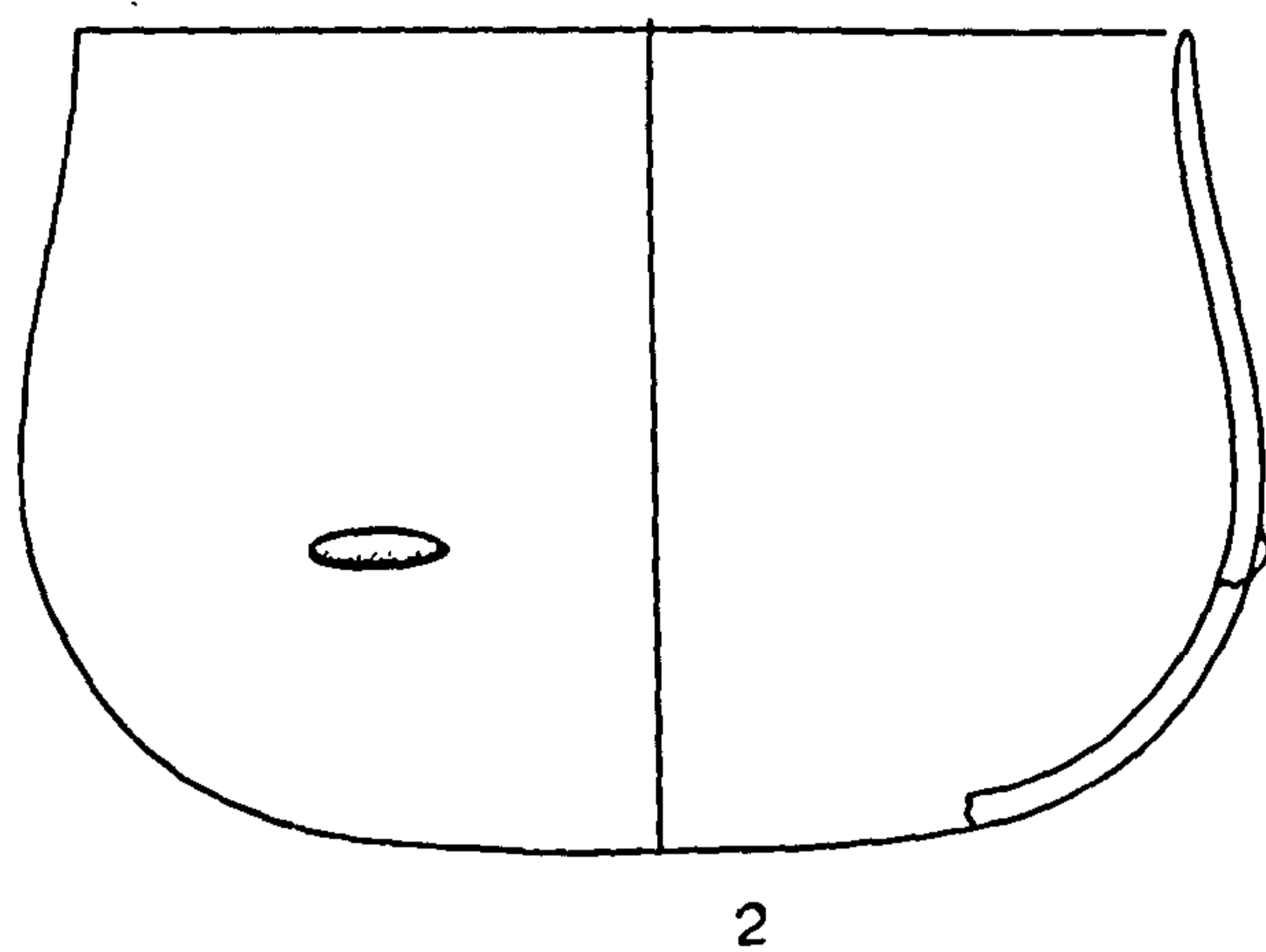
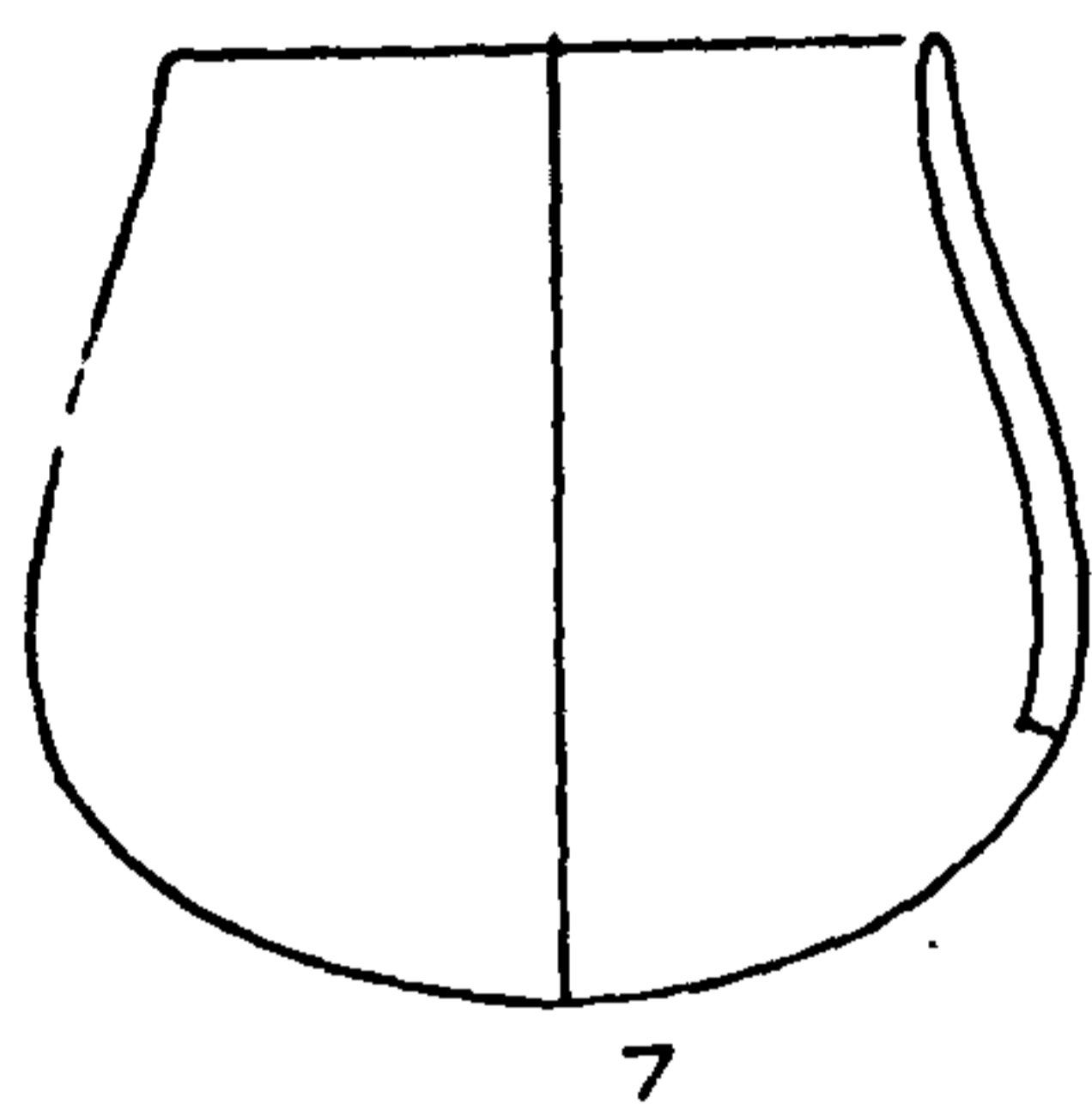
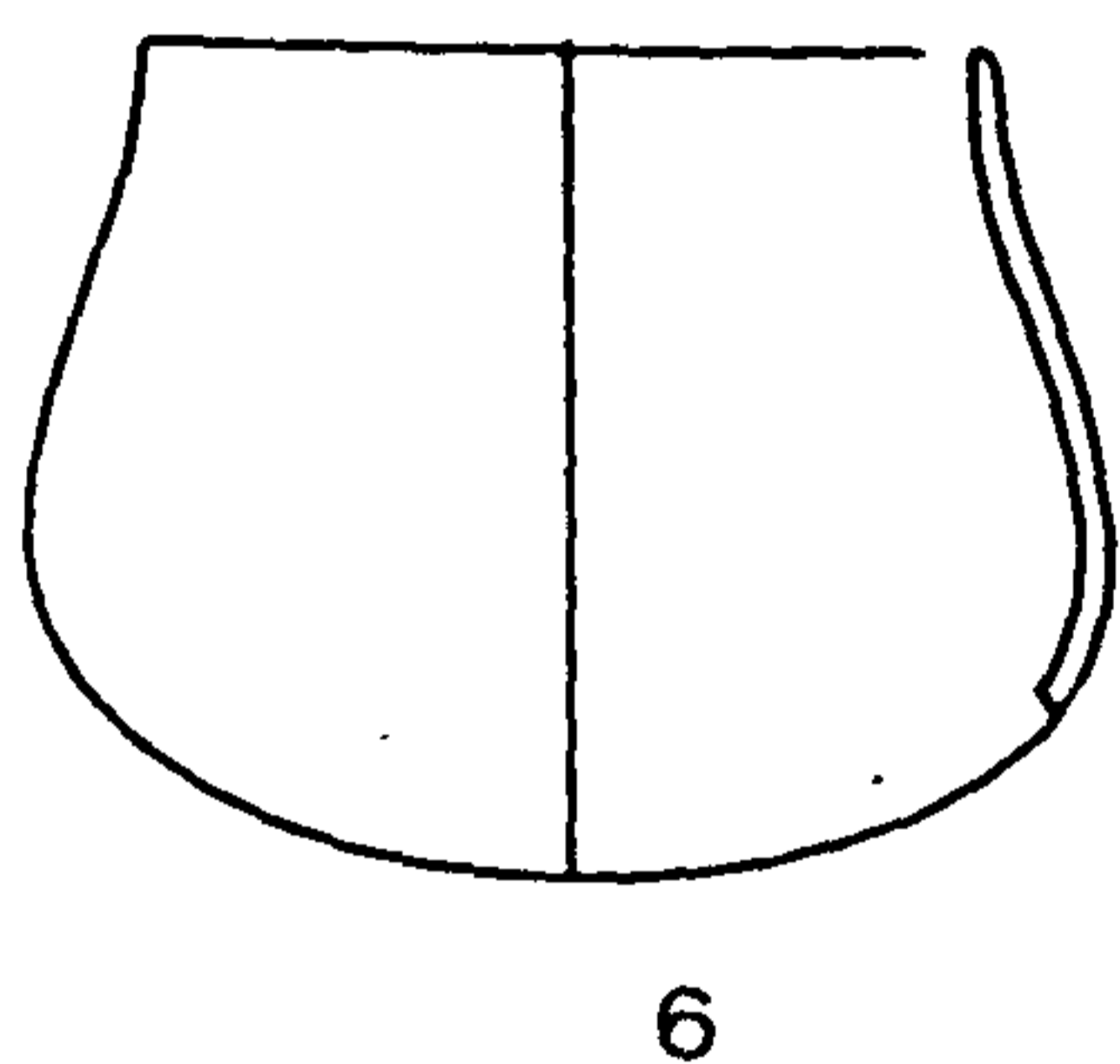
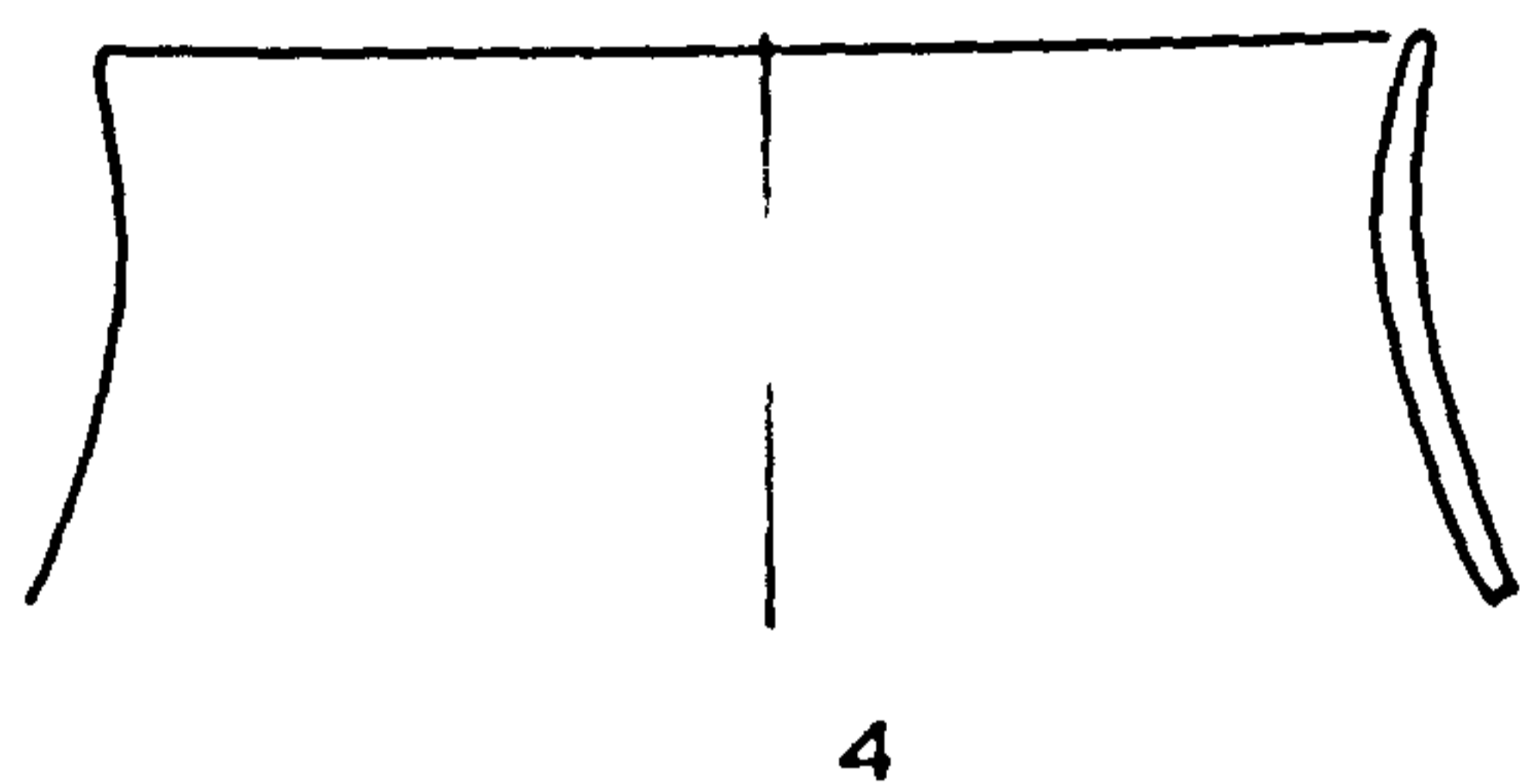
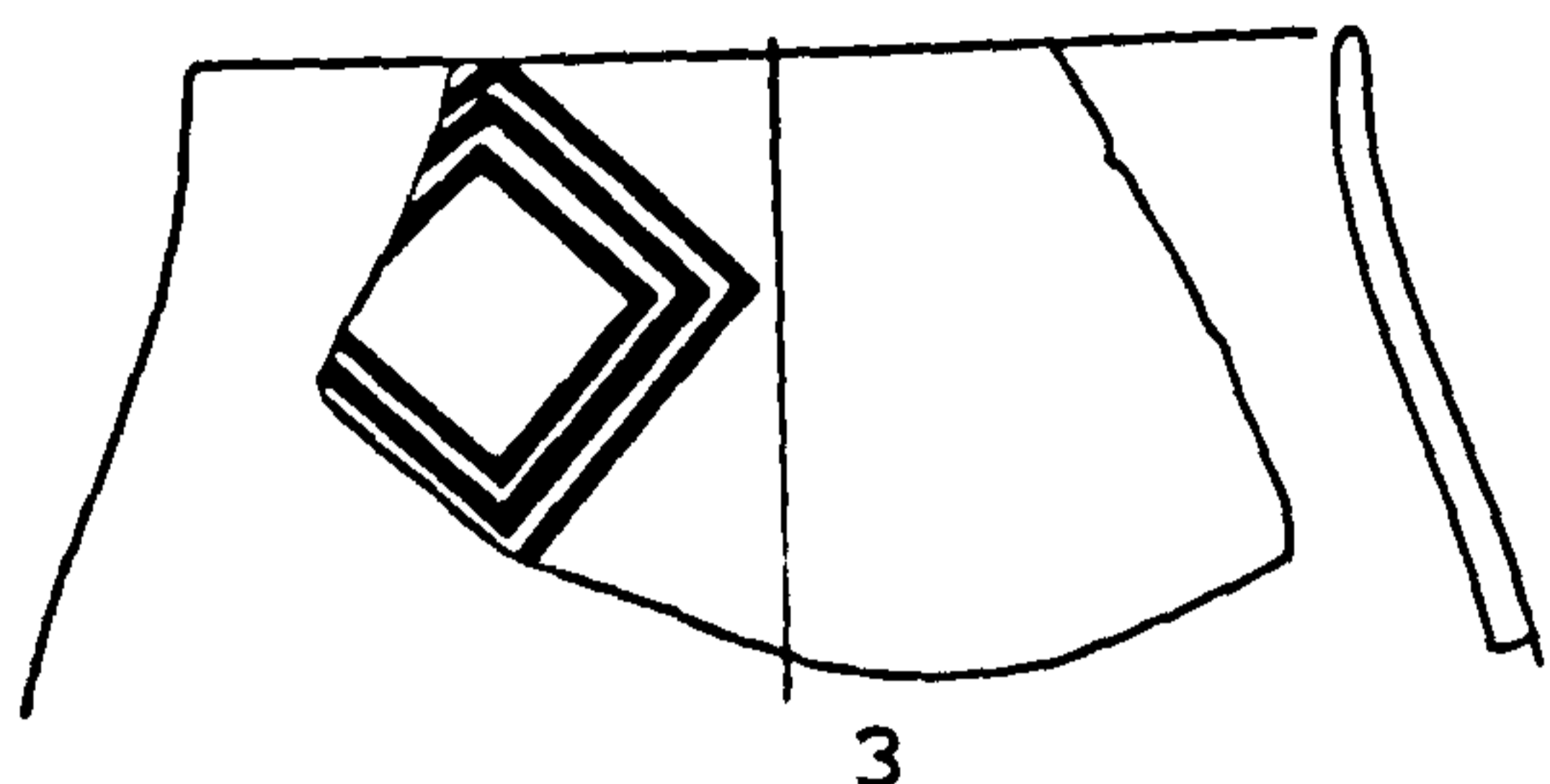
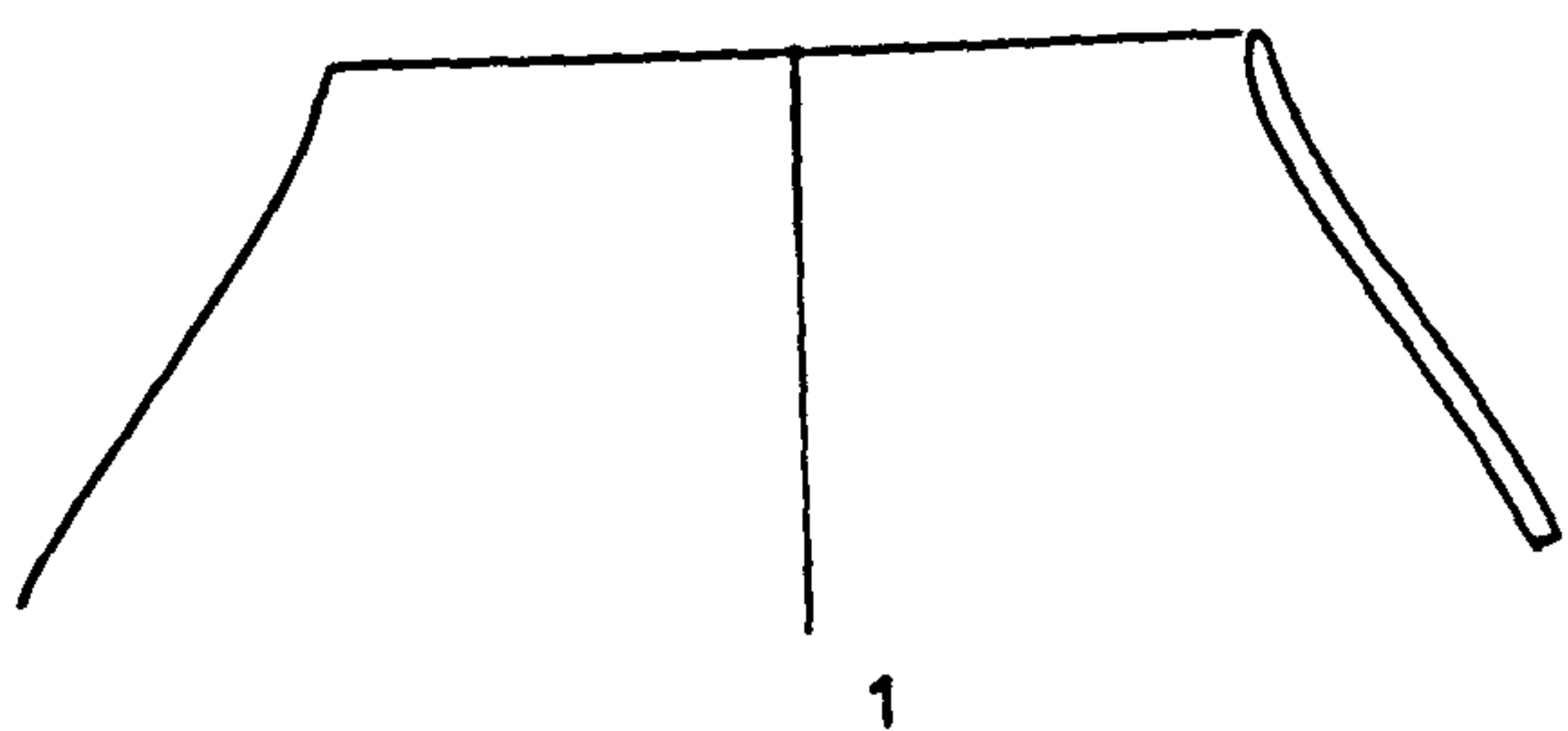
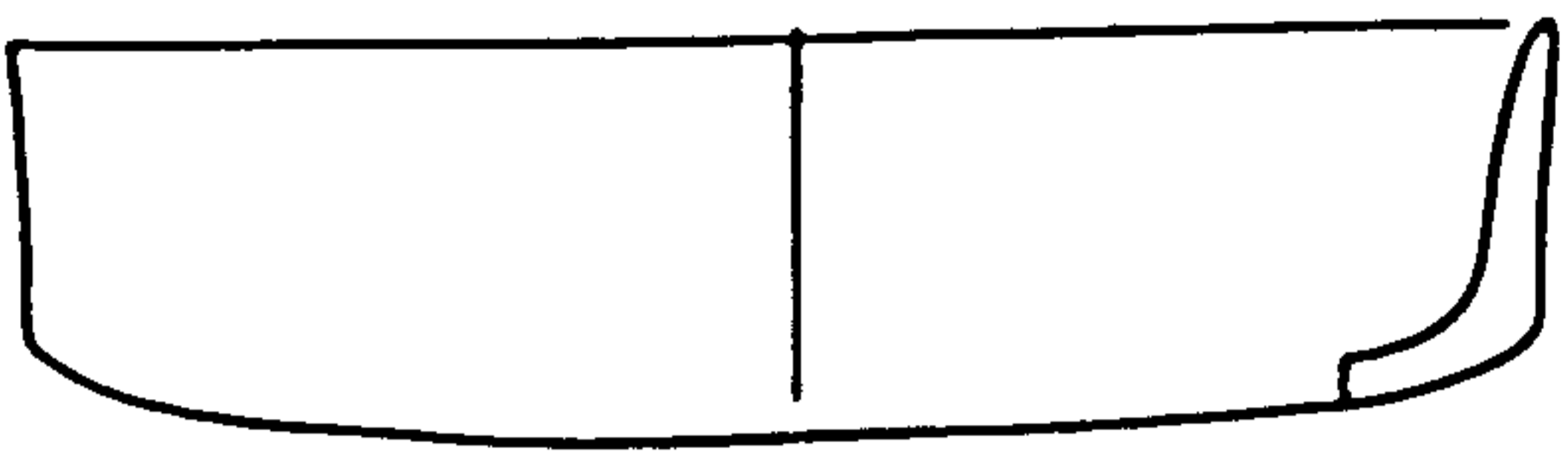
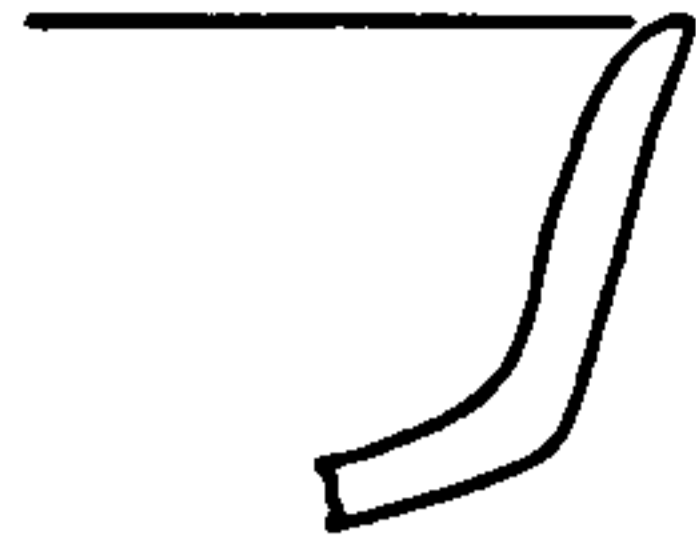

Fig 15



1



2

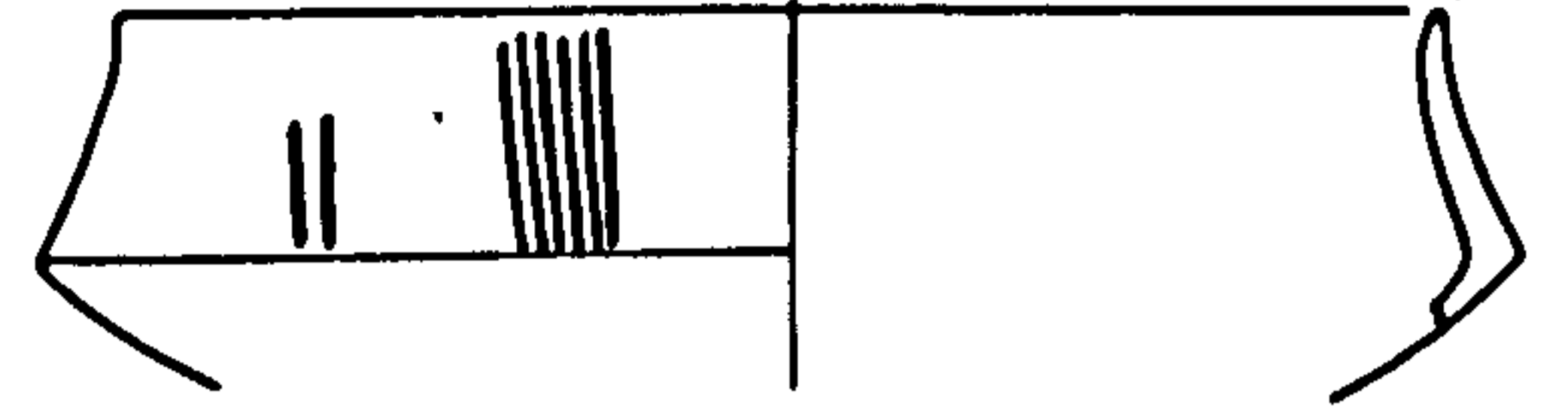

3

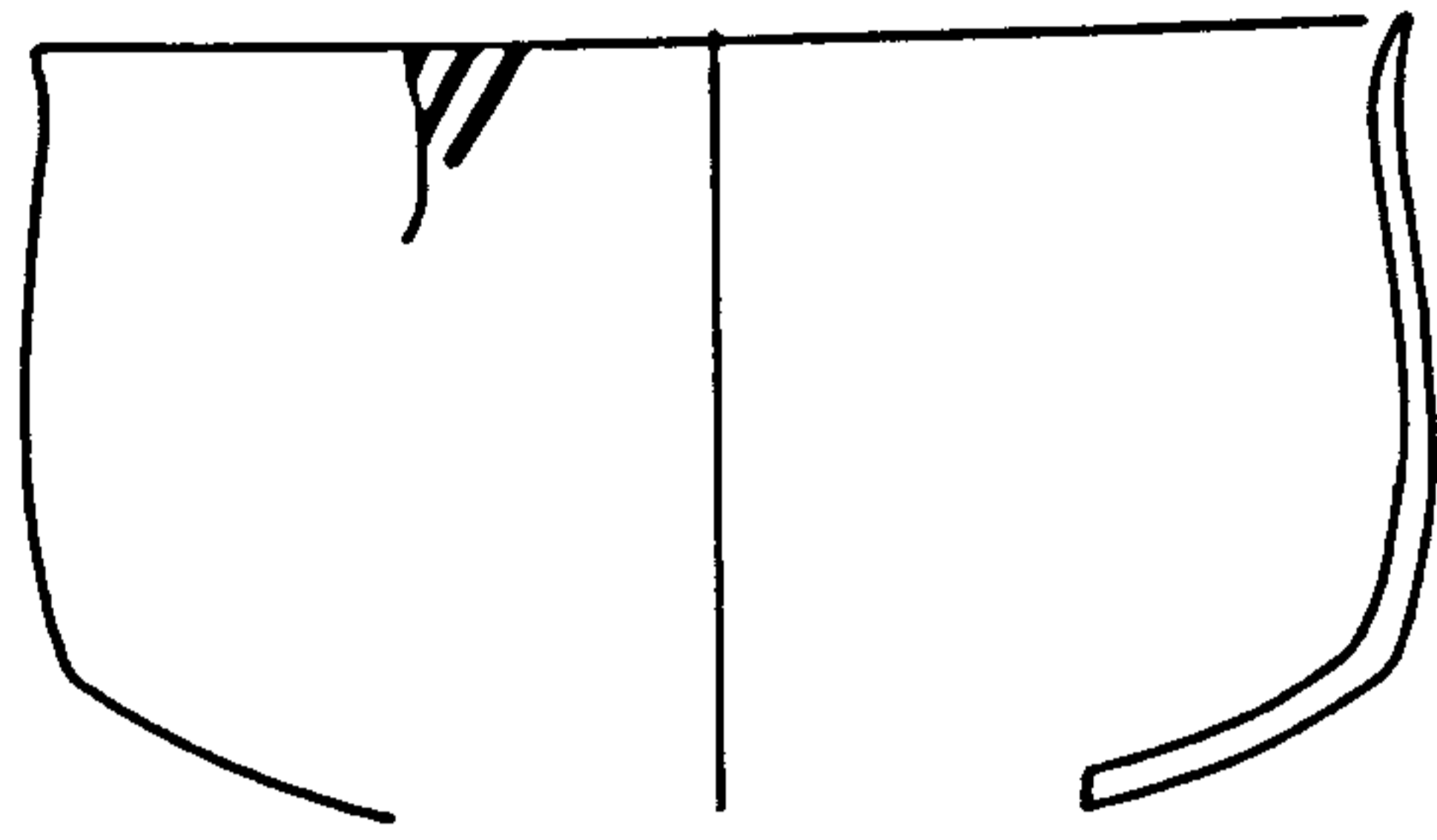

4

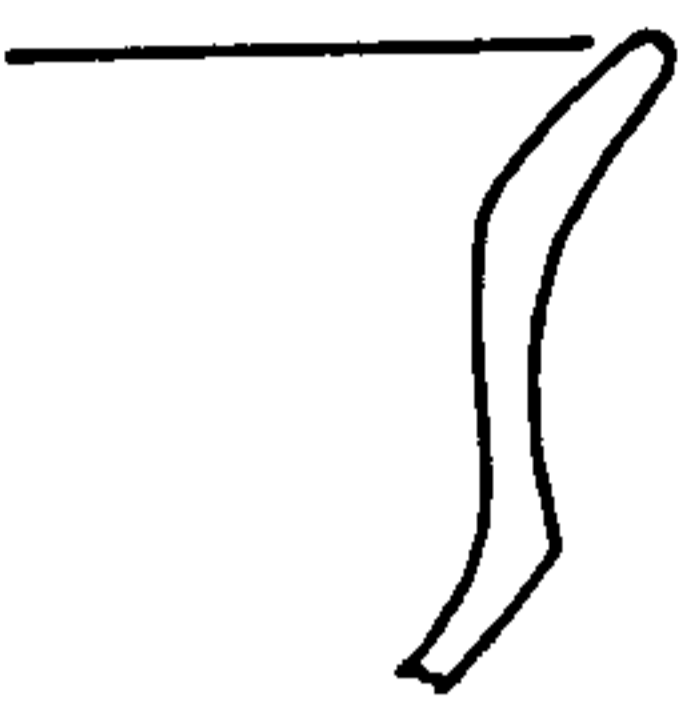

5

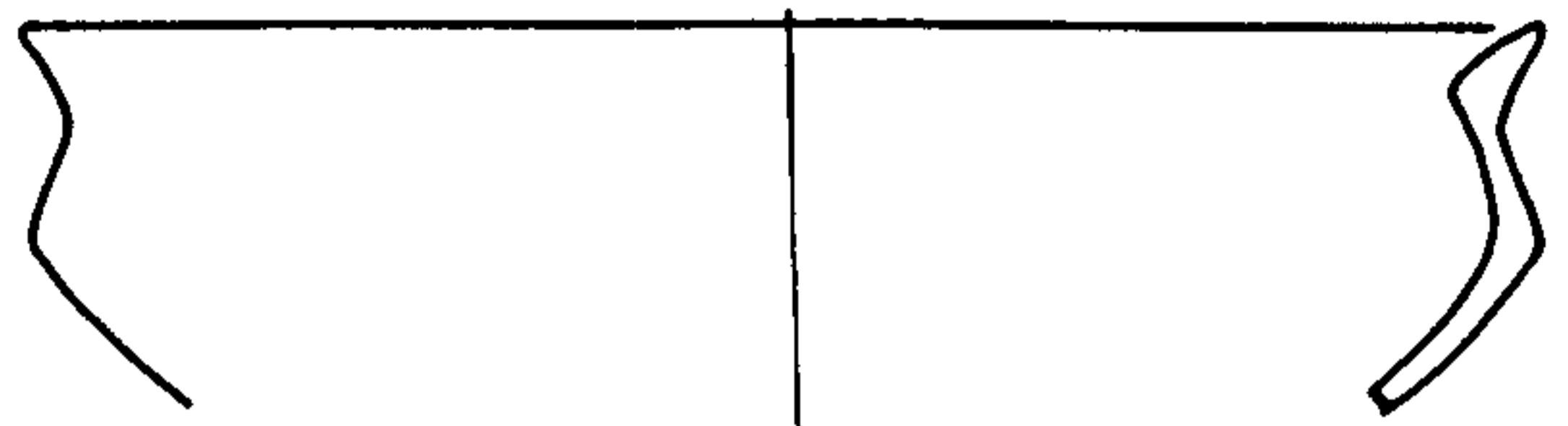

6

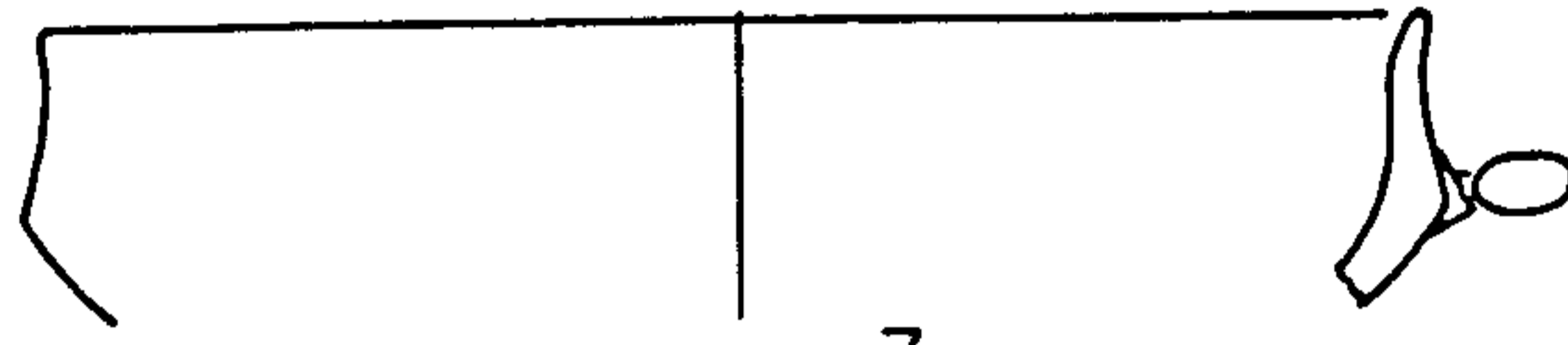

7

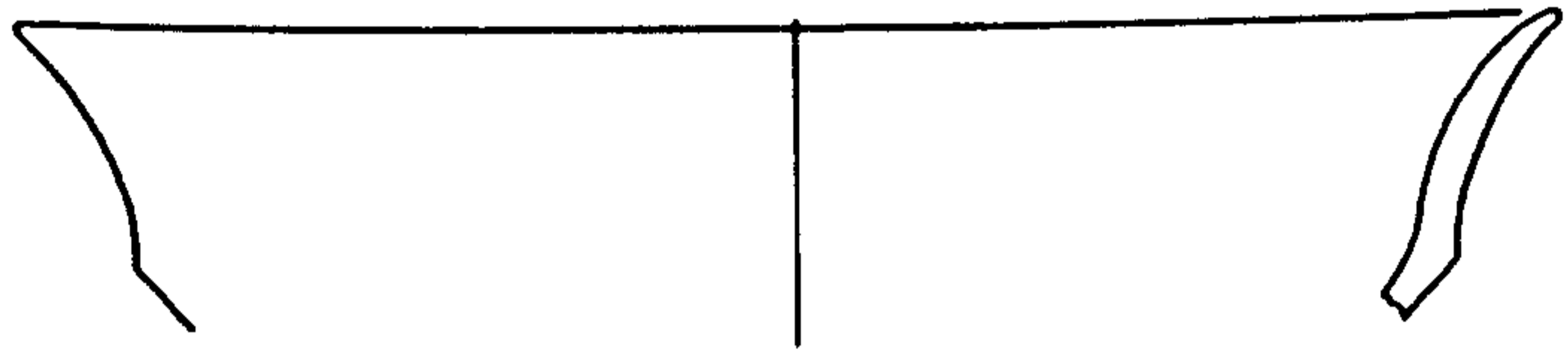

8

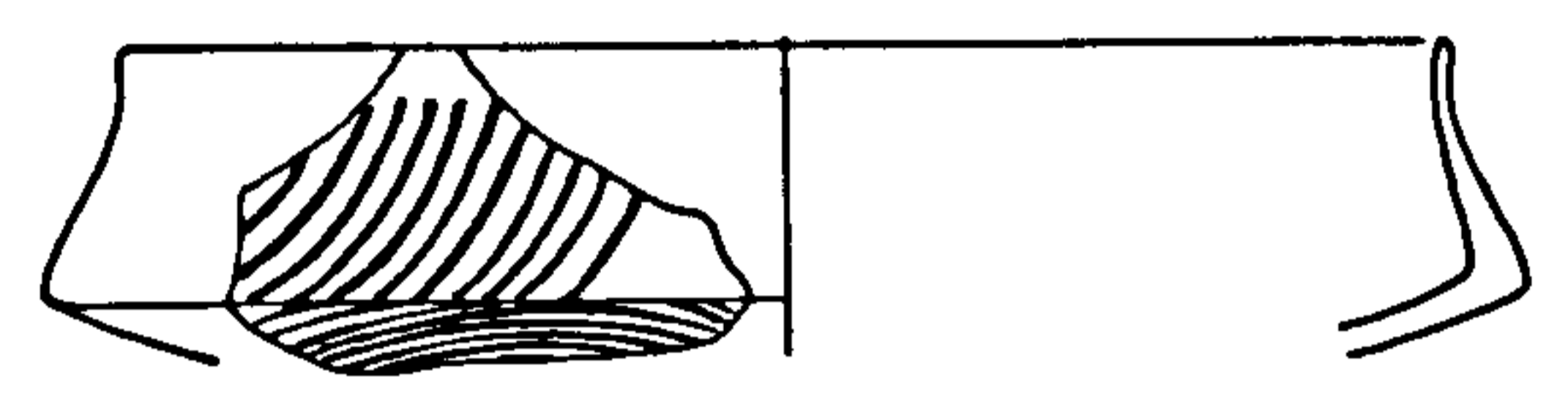

9

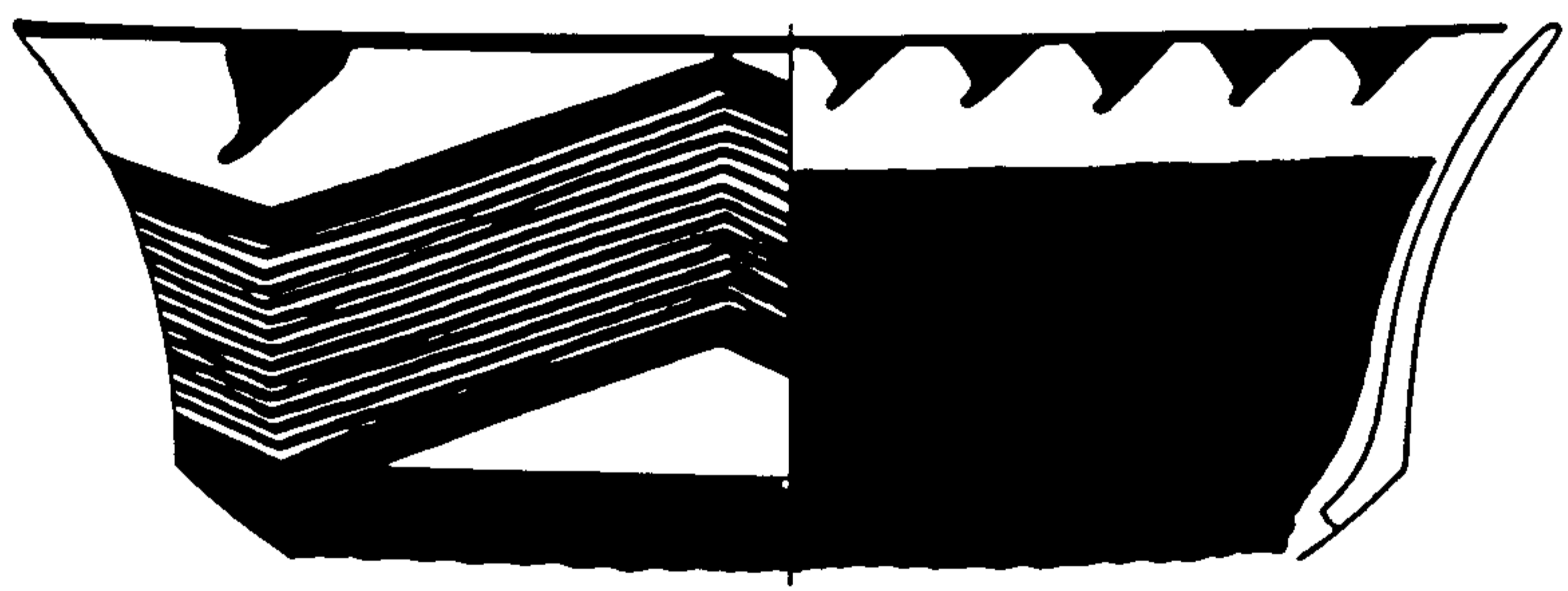

10

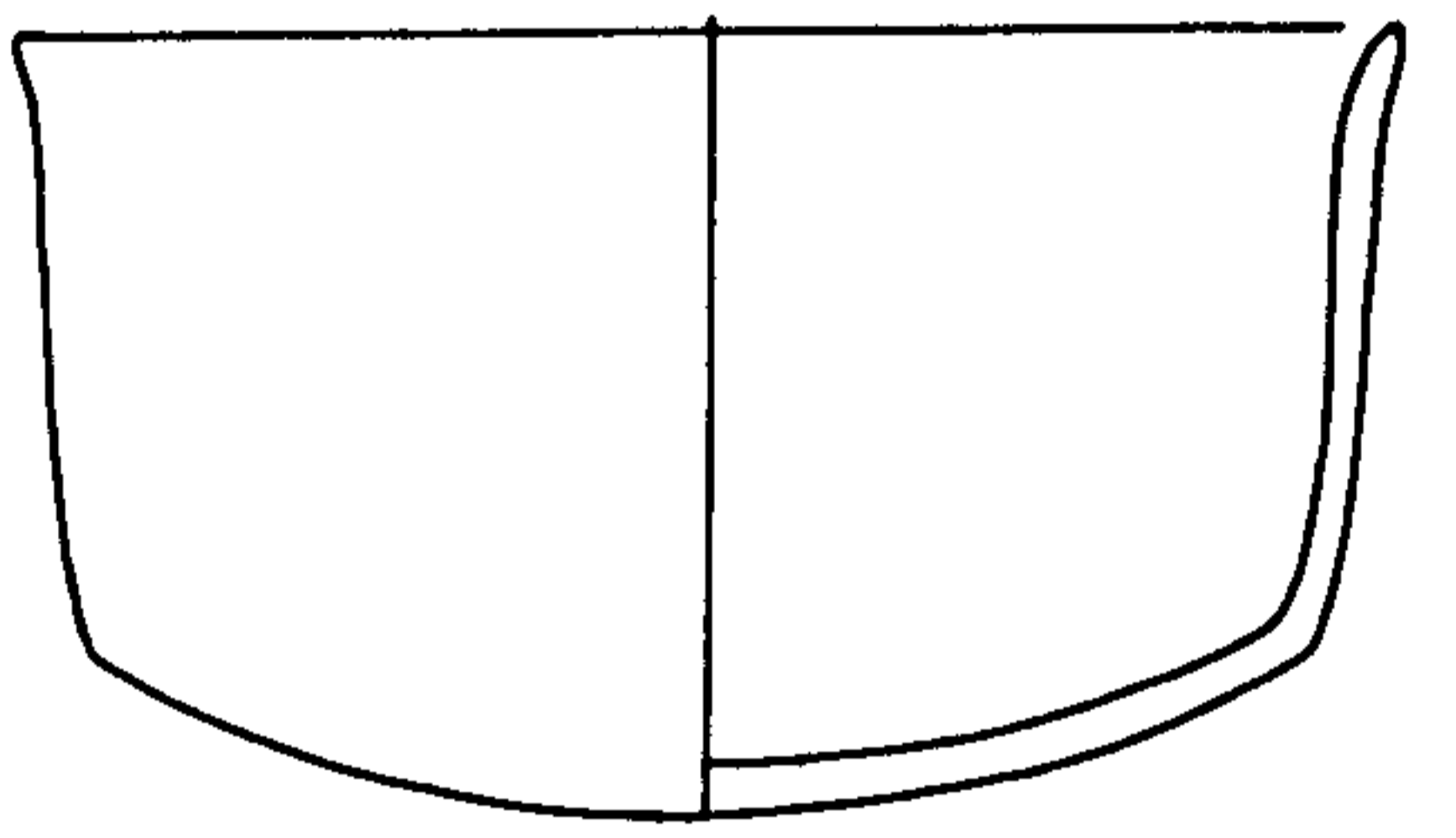

11

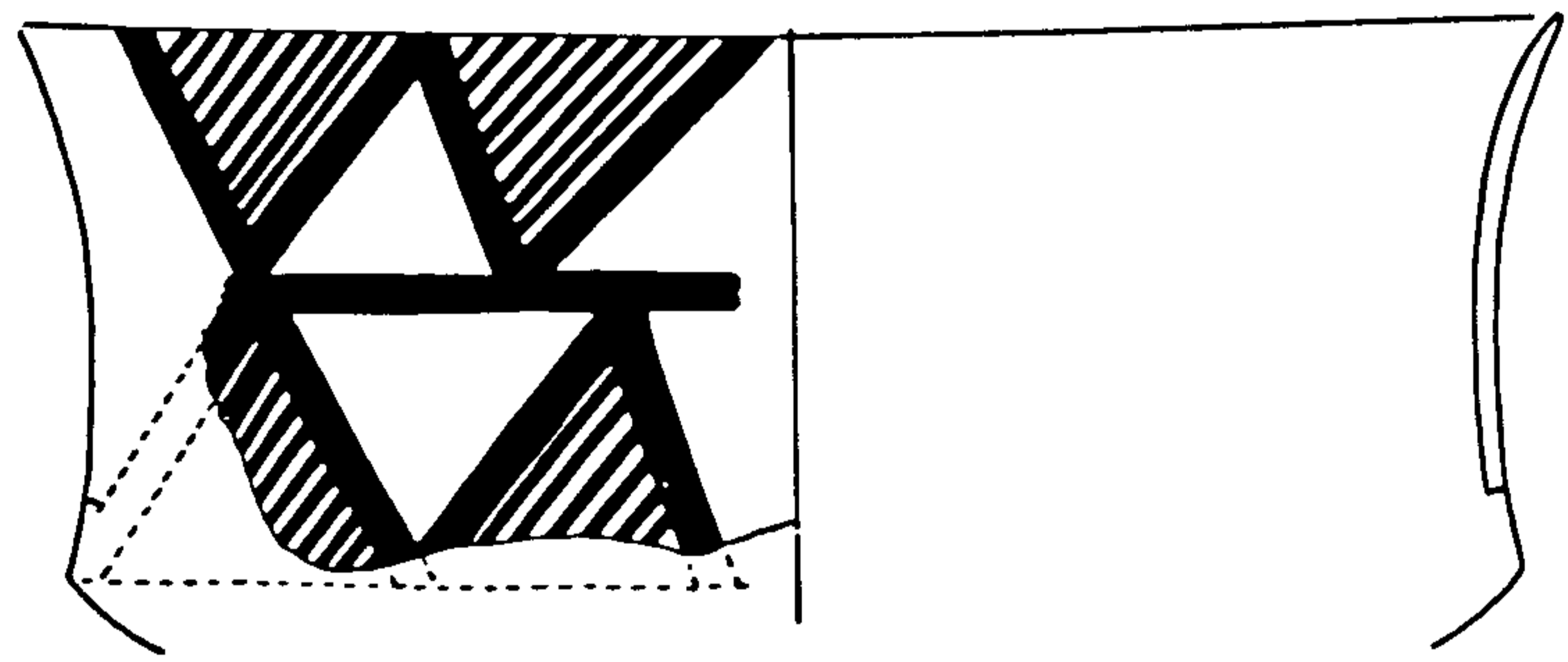

12

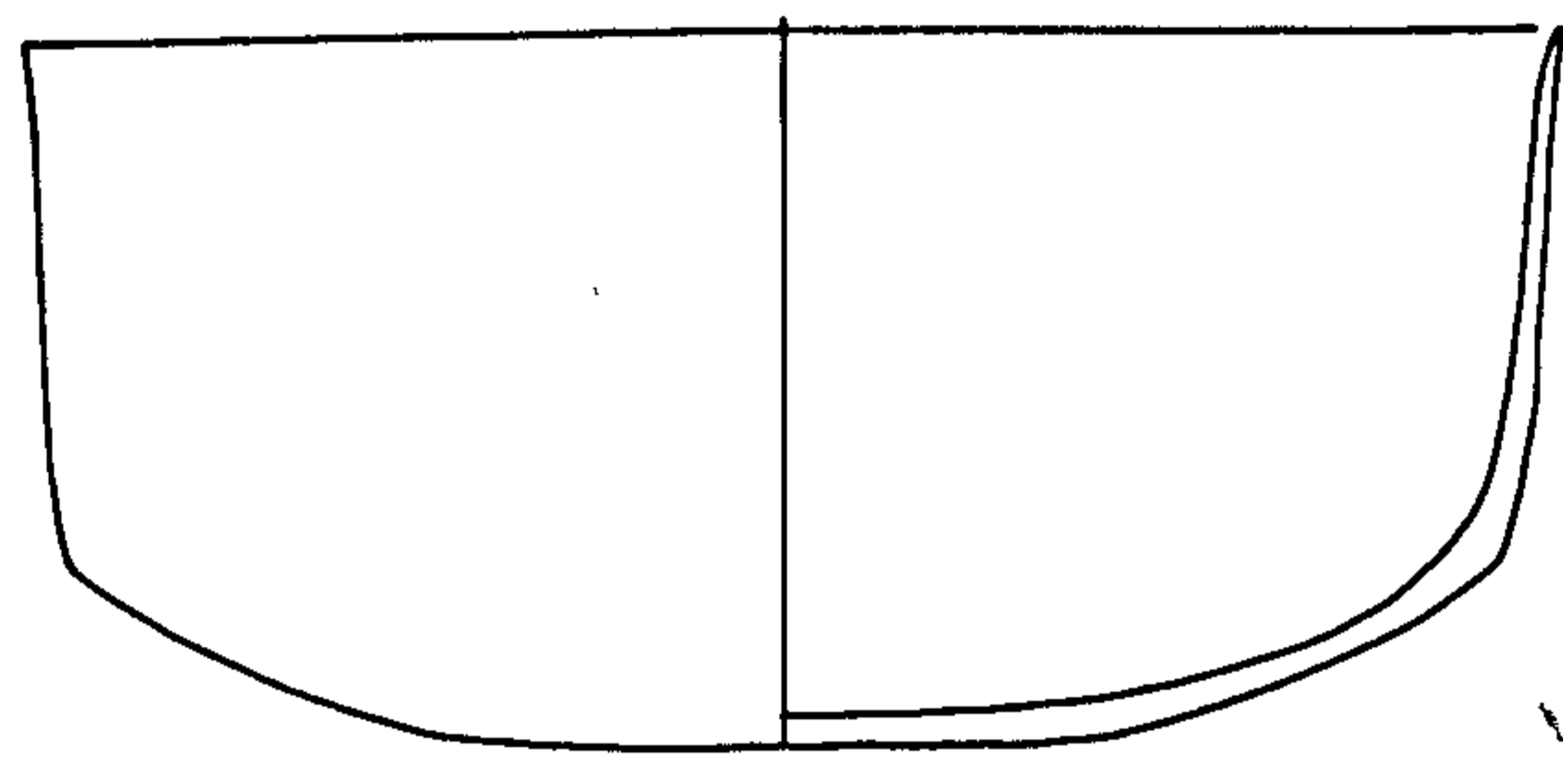

13

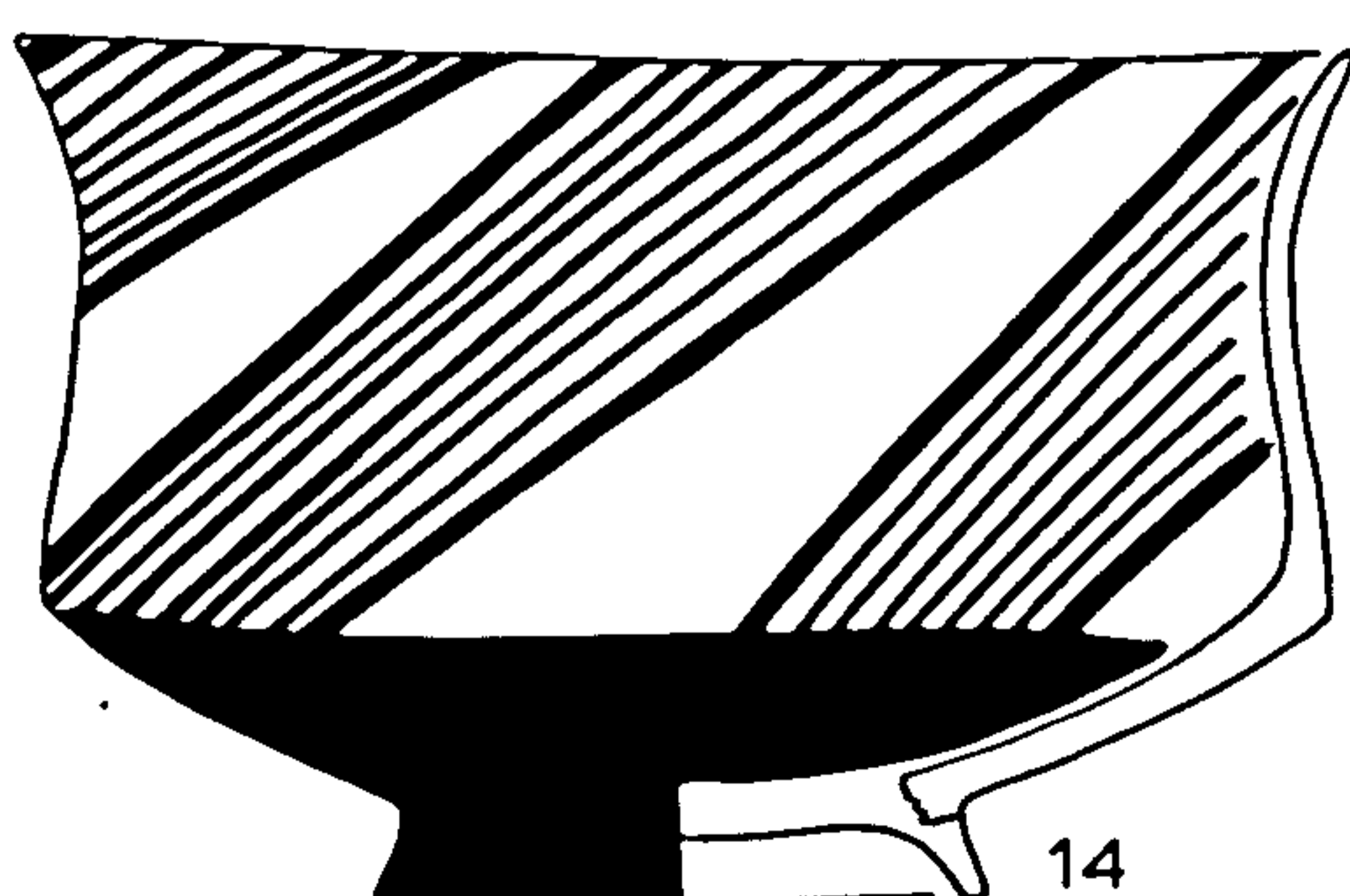

14

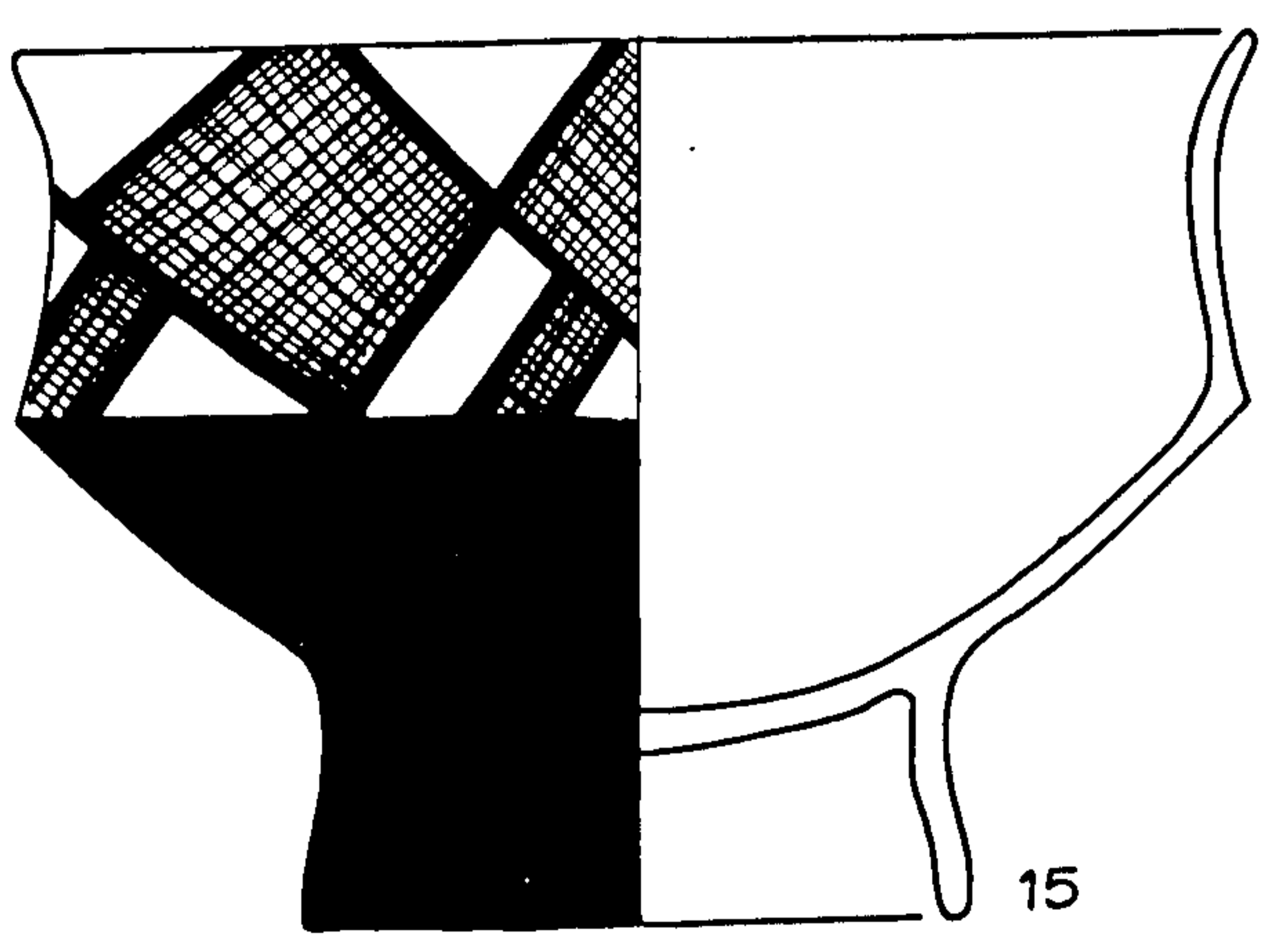

15

Fig 16

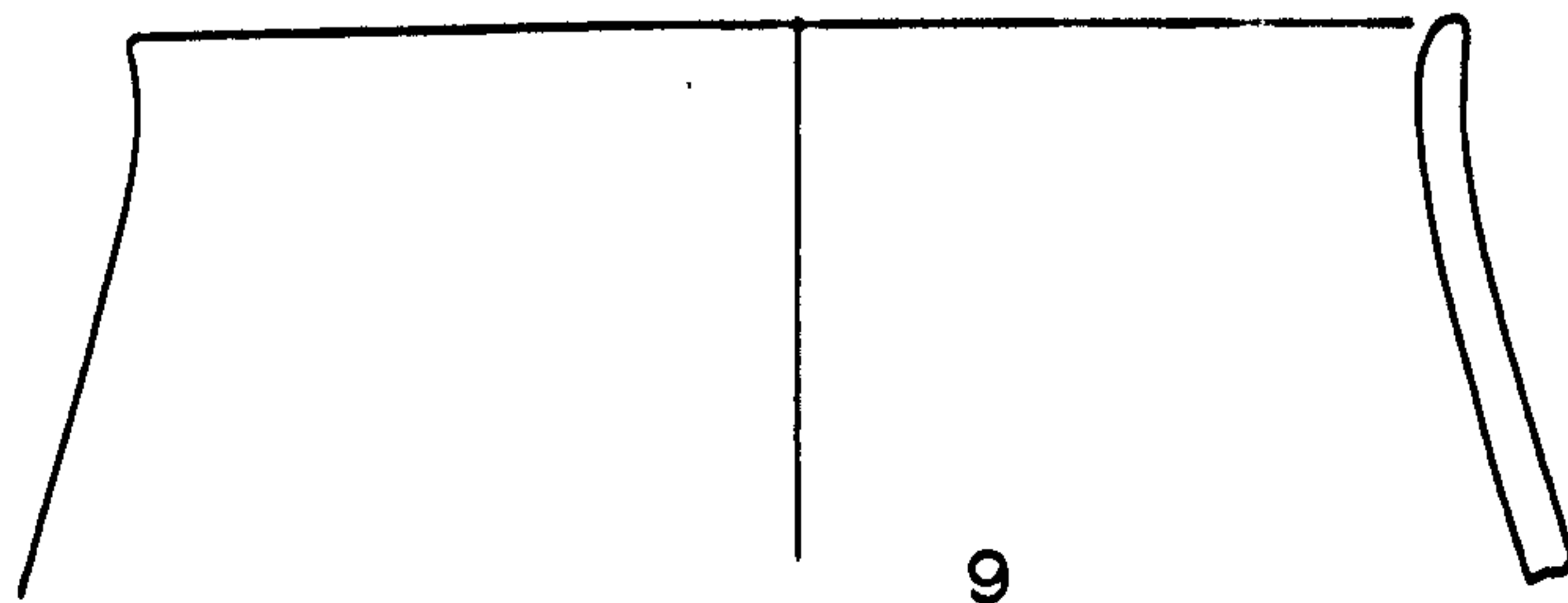
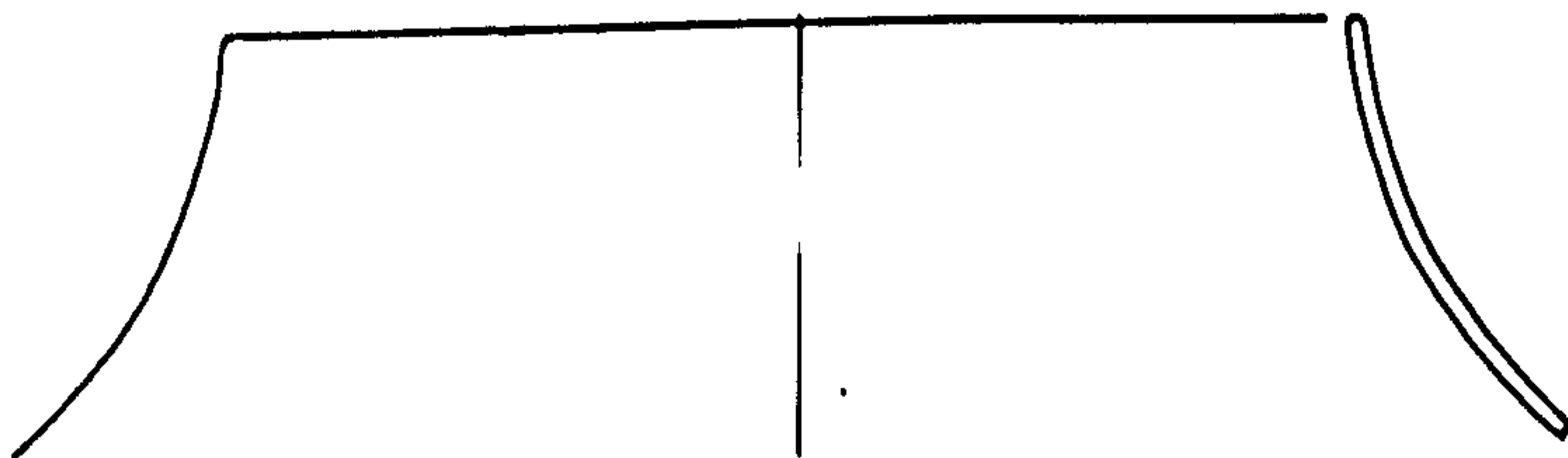
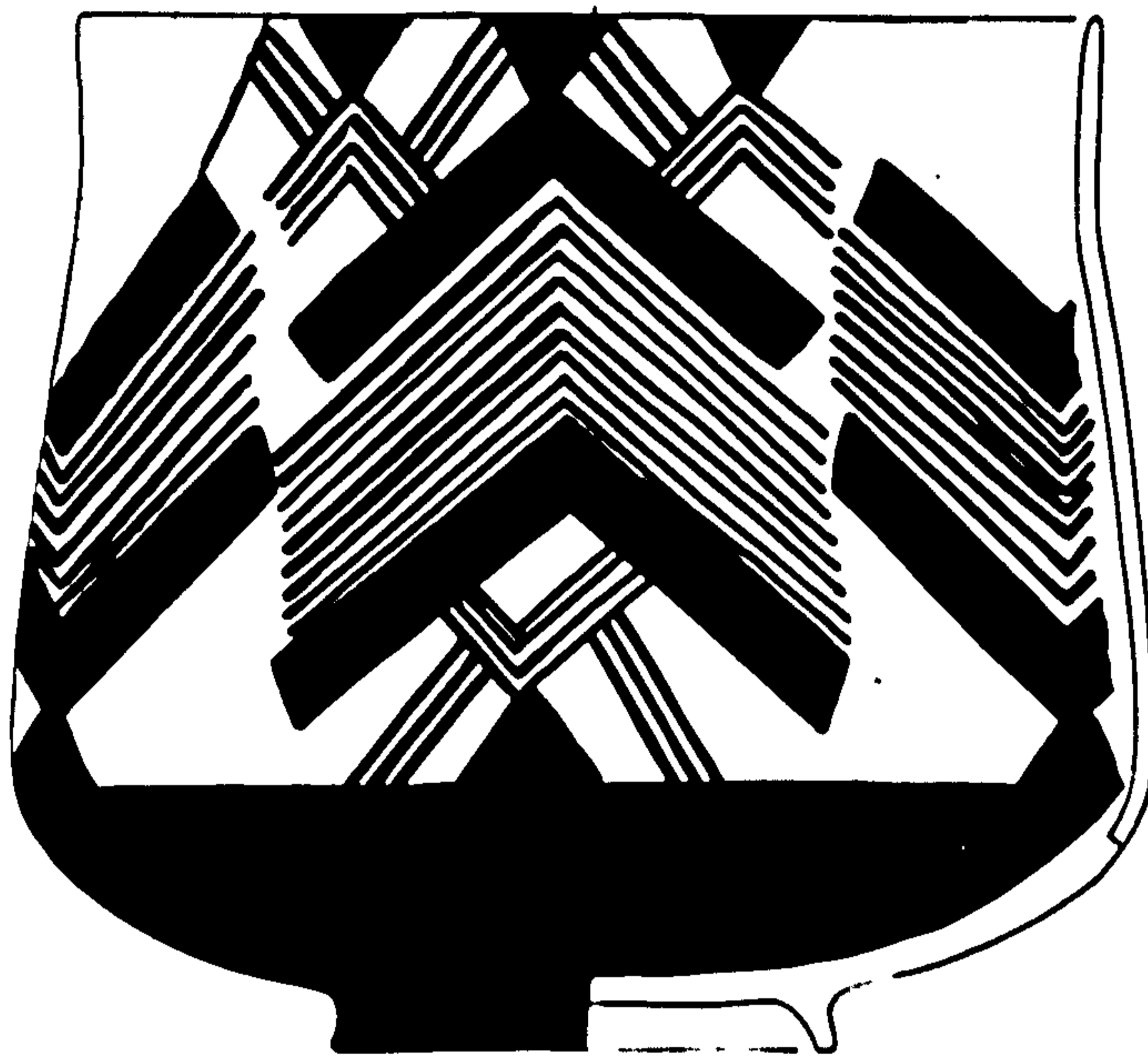
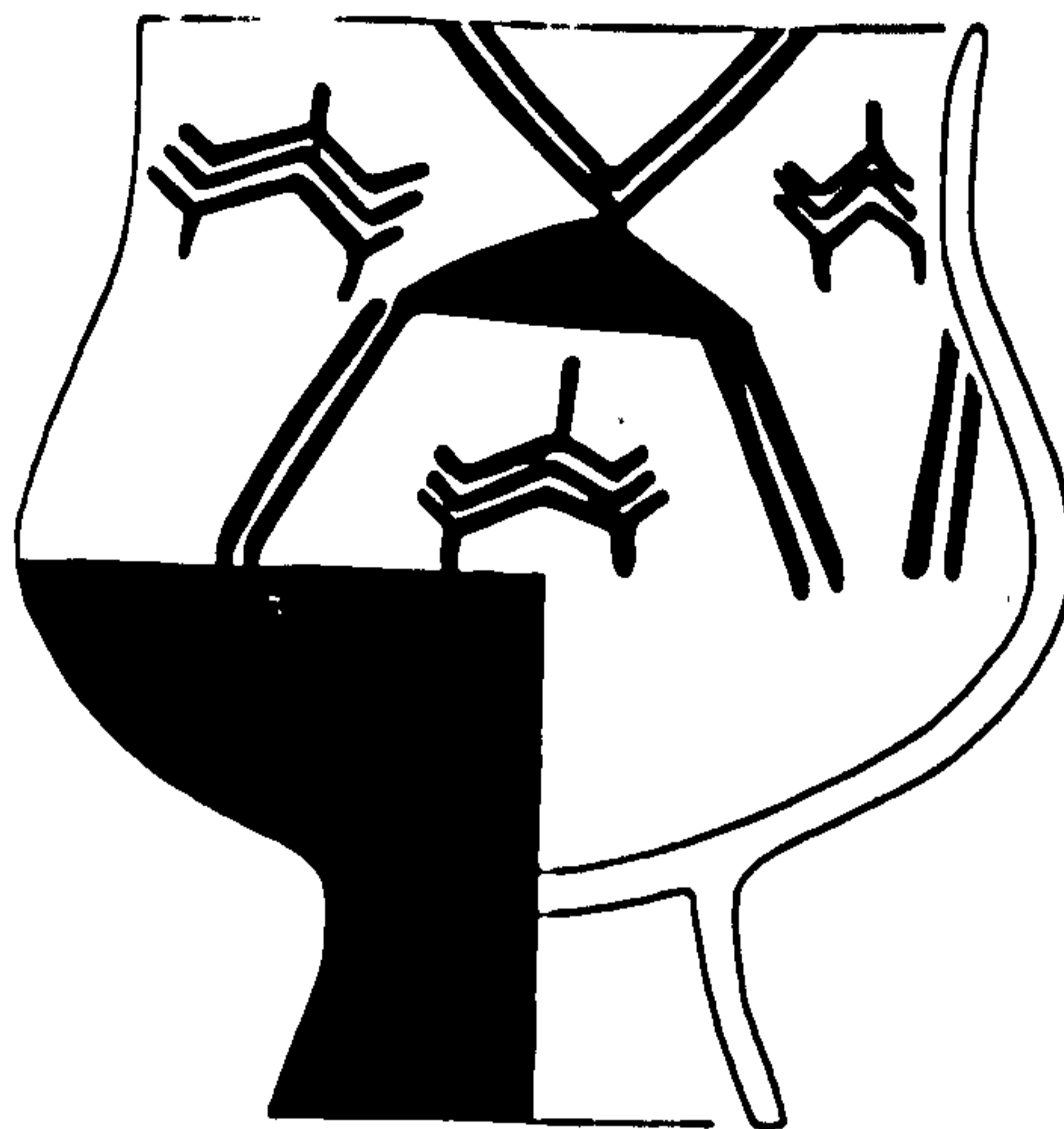
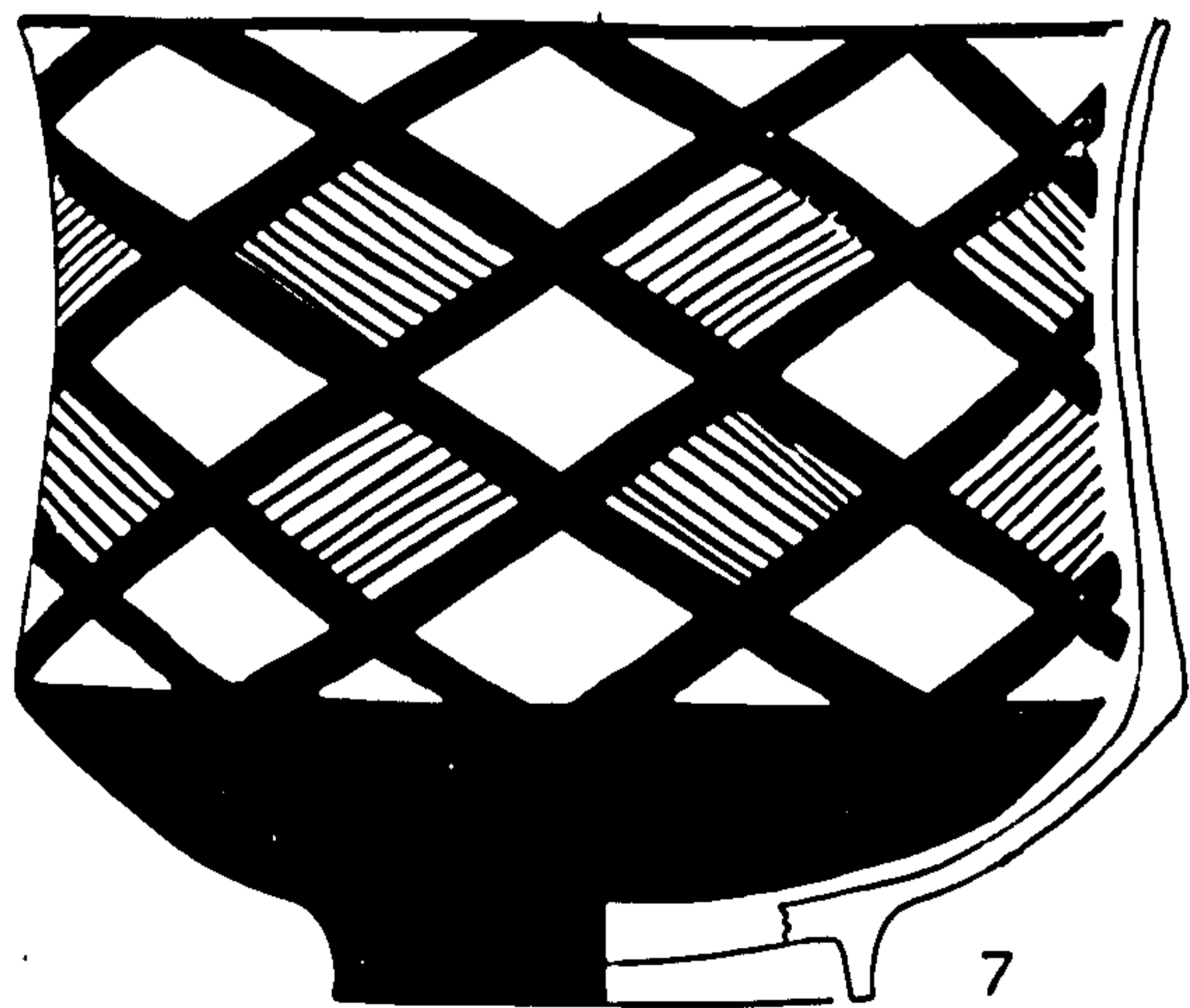
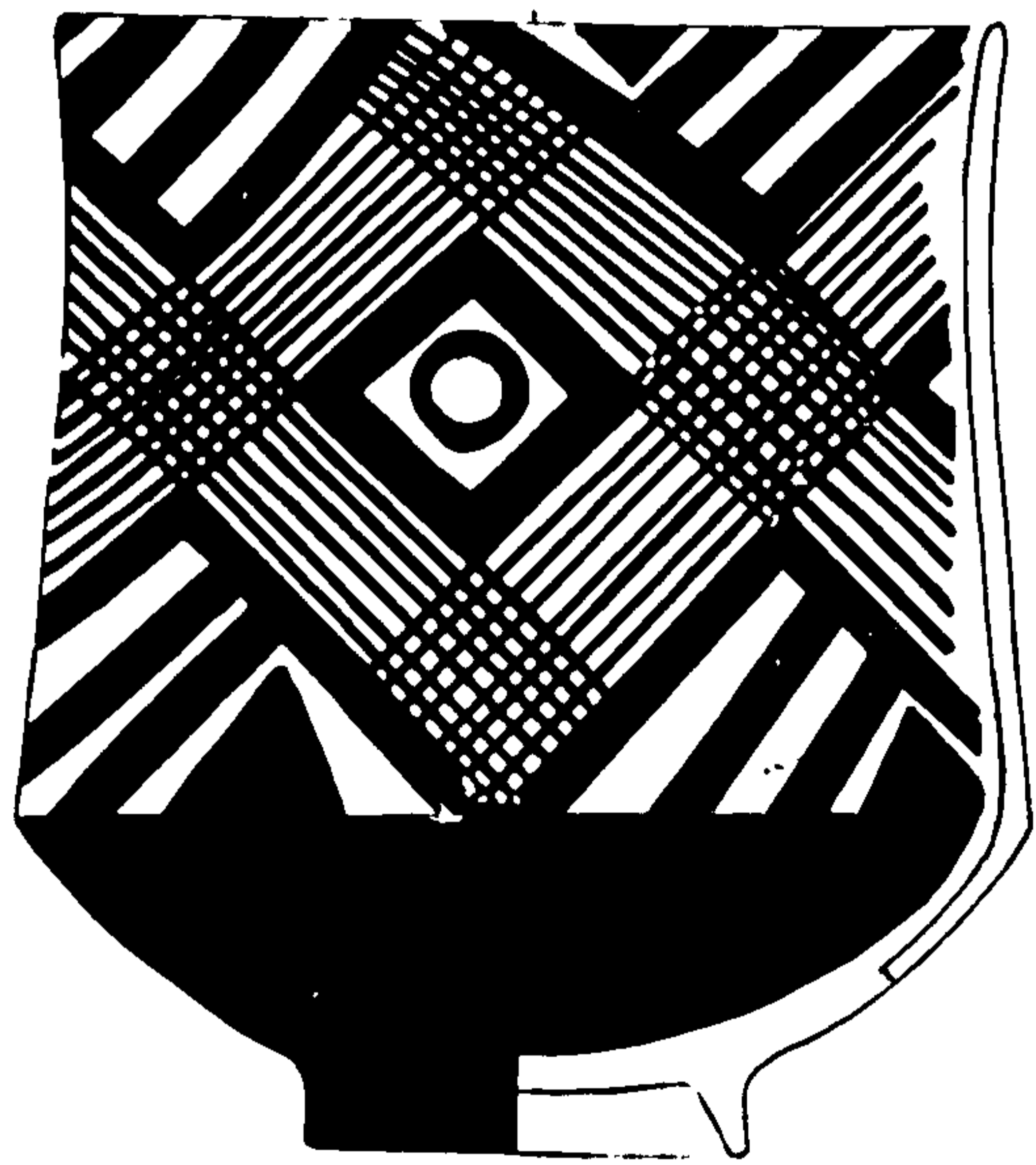
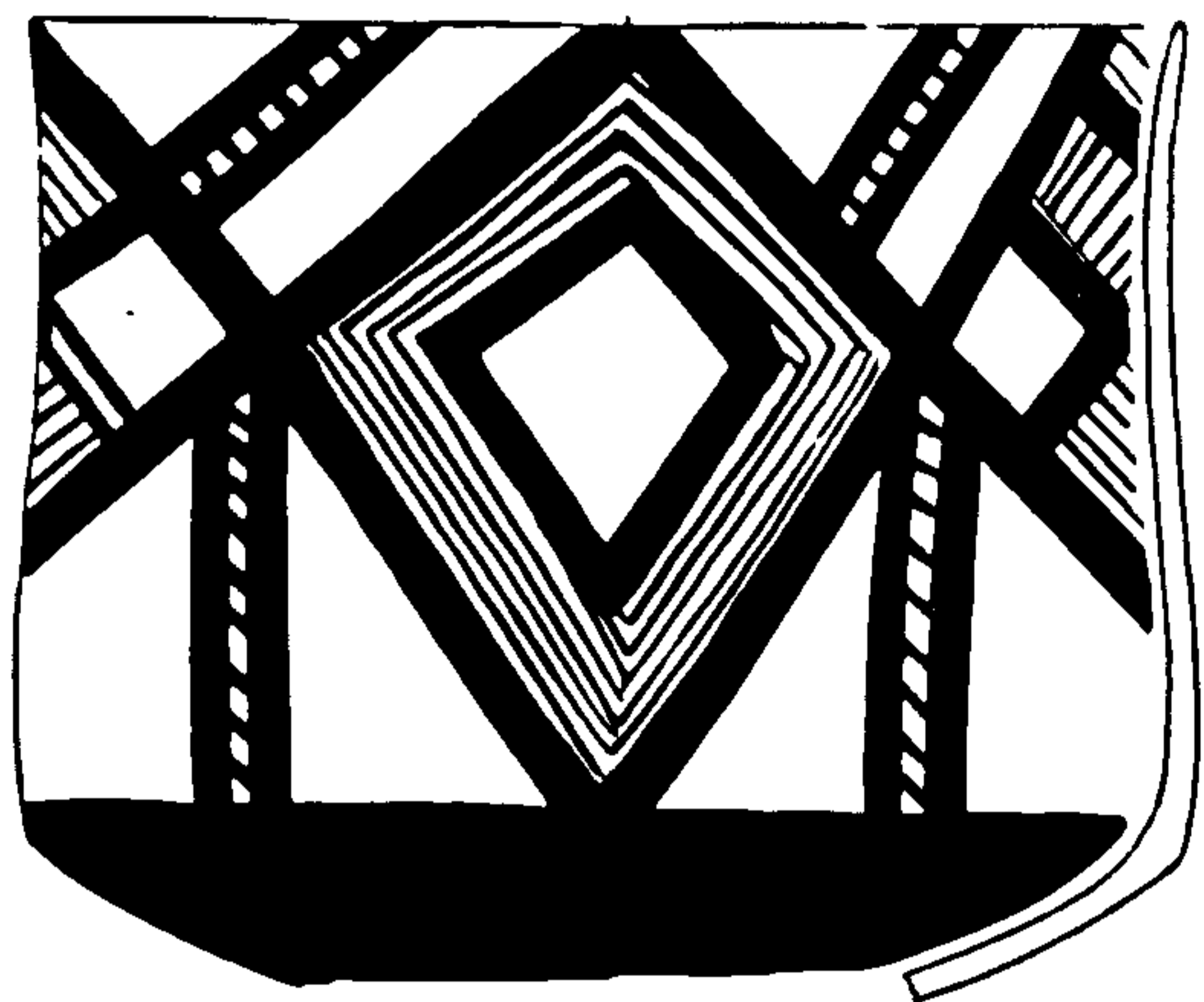
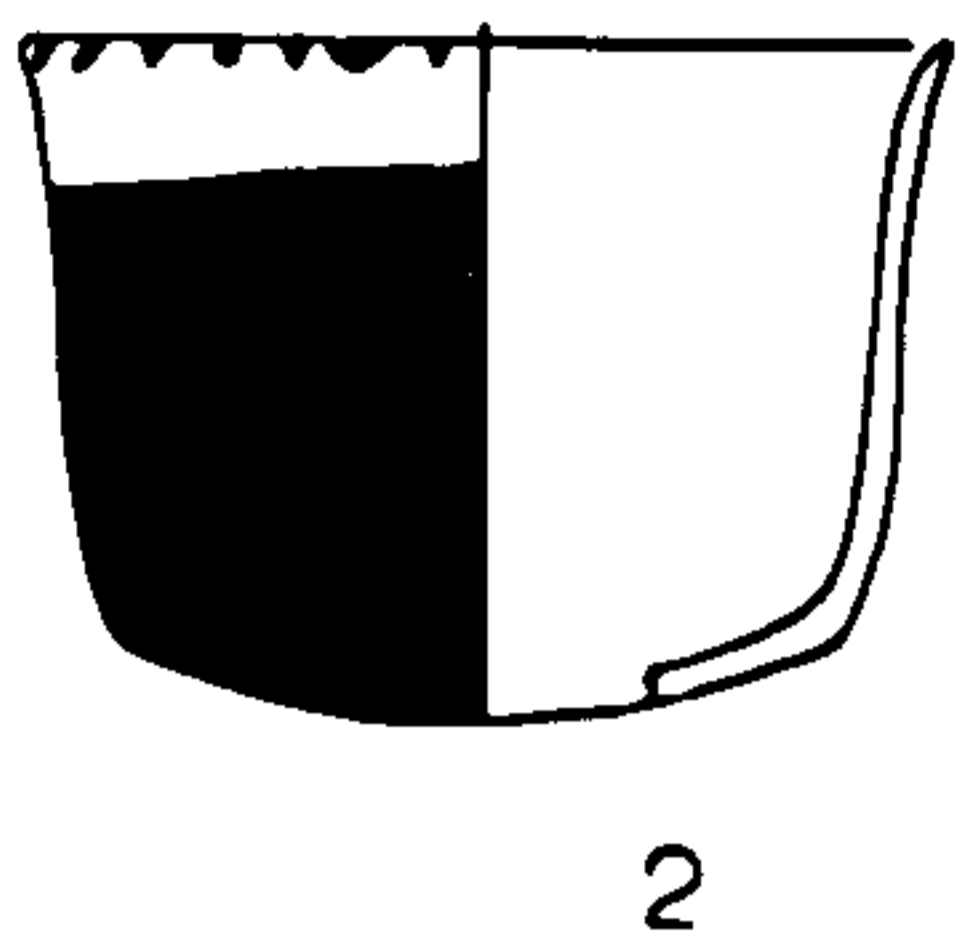
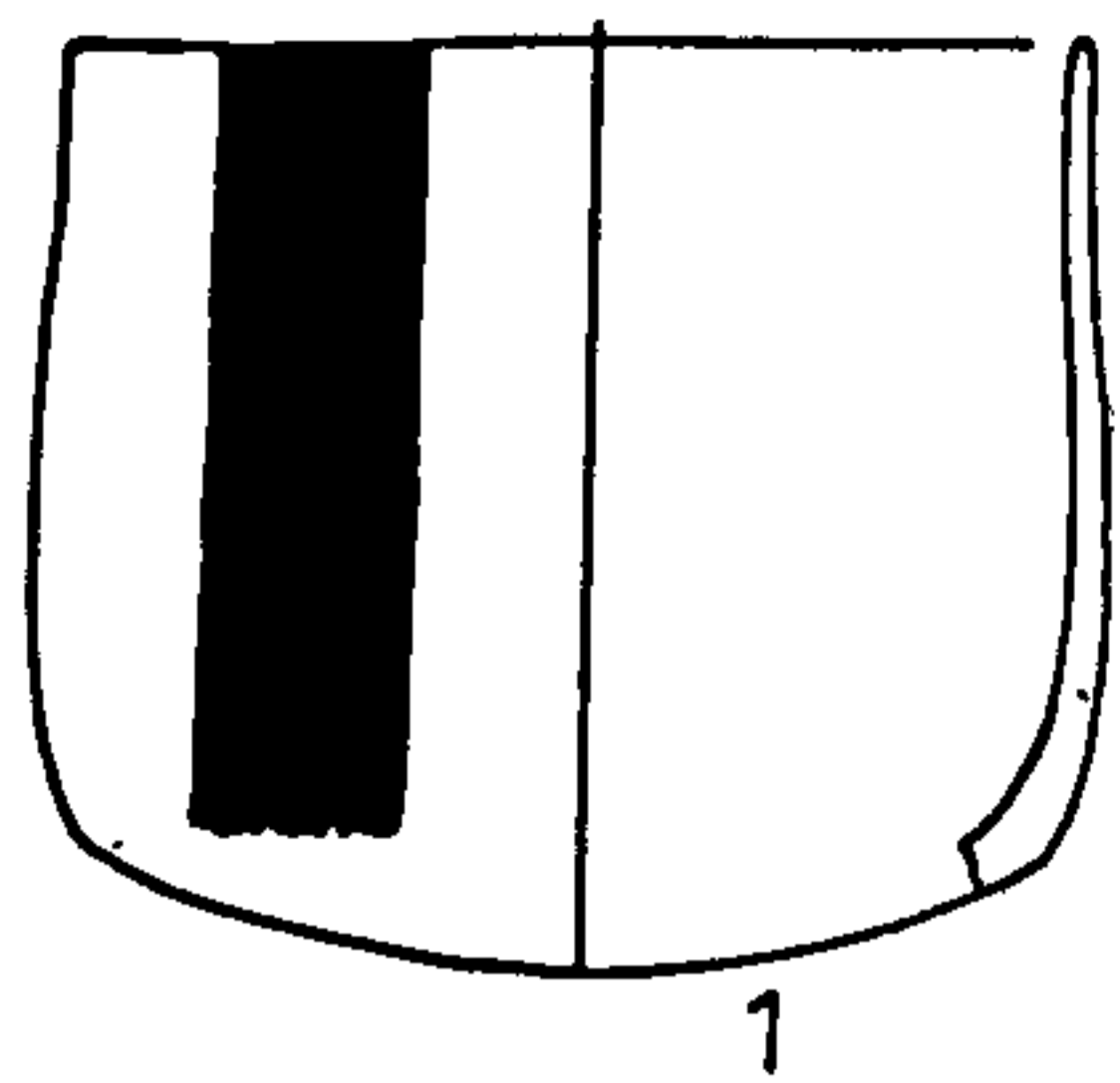
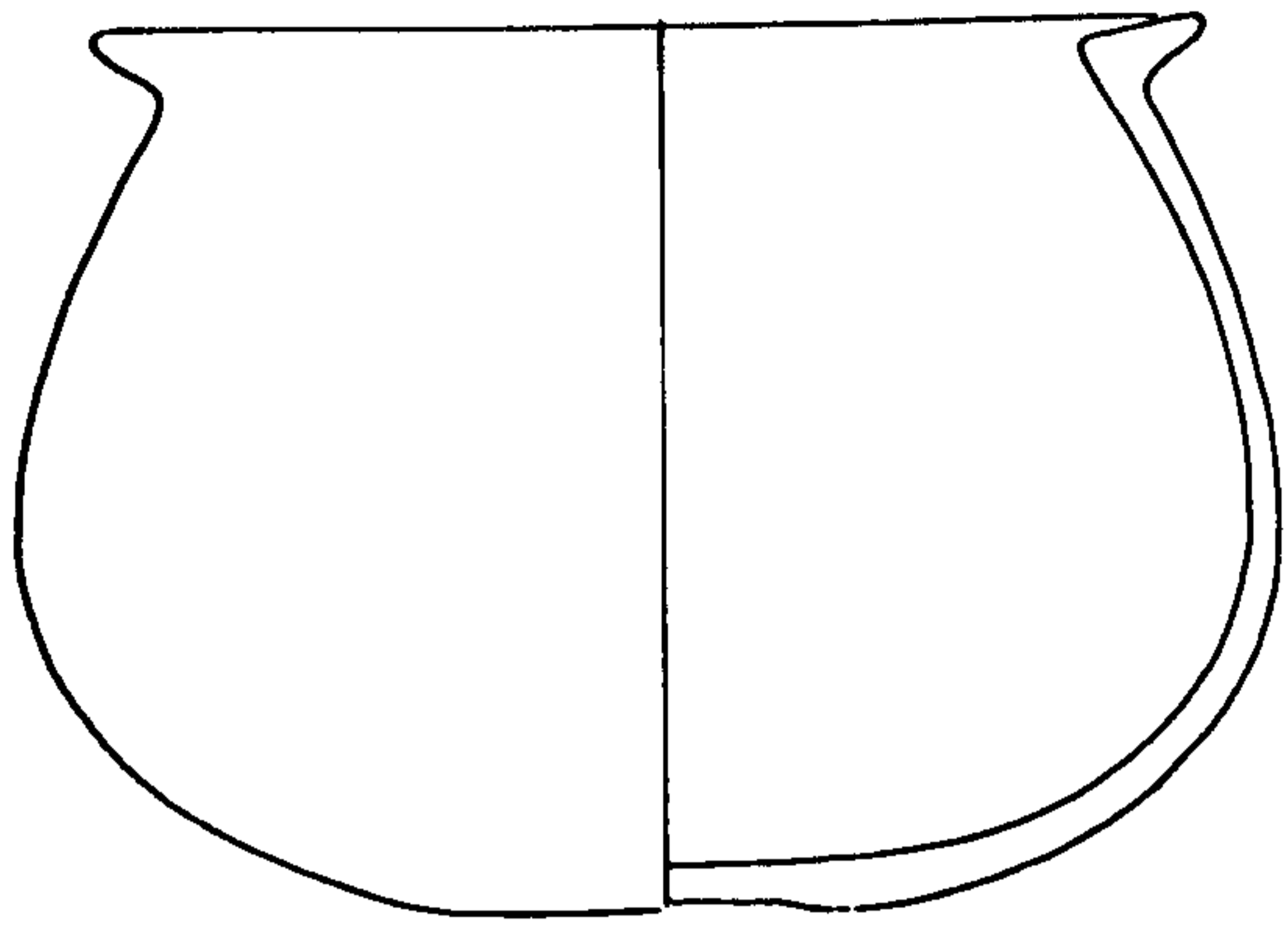
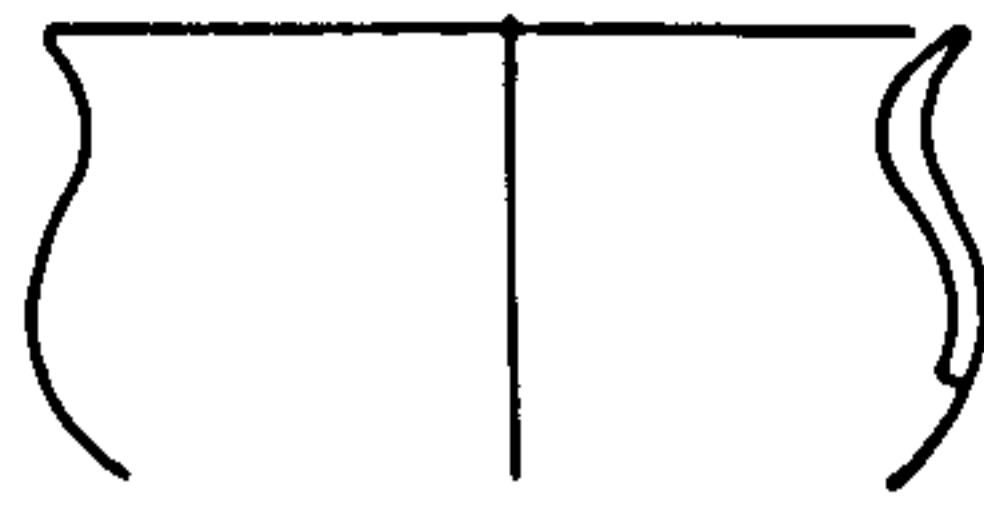

Fig 17



1



2

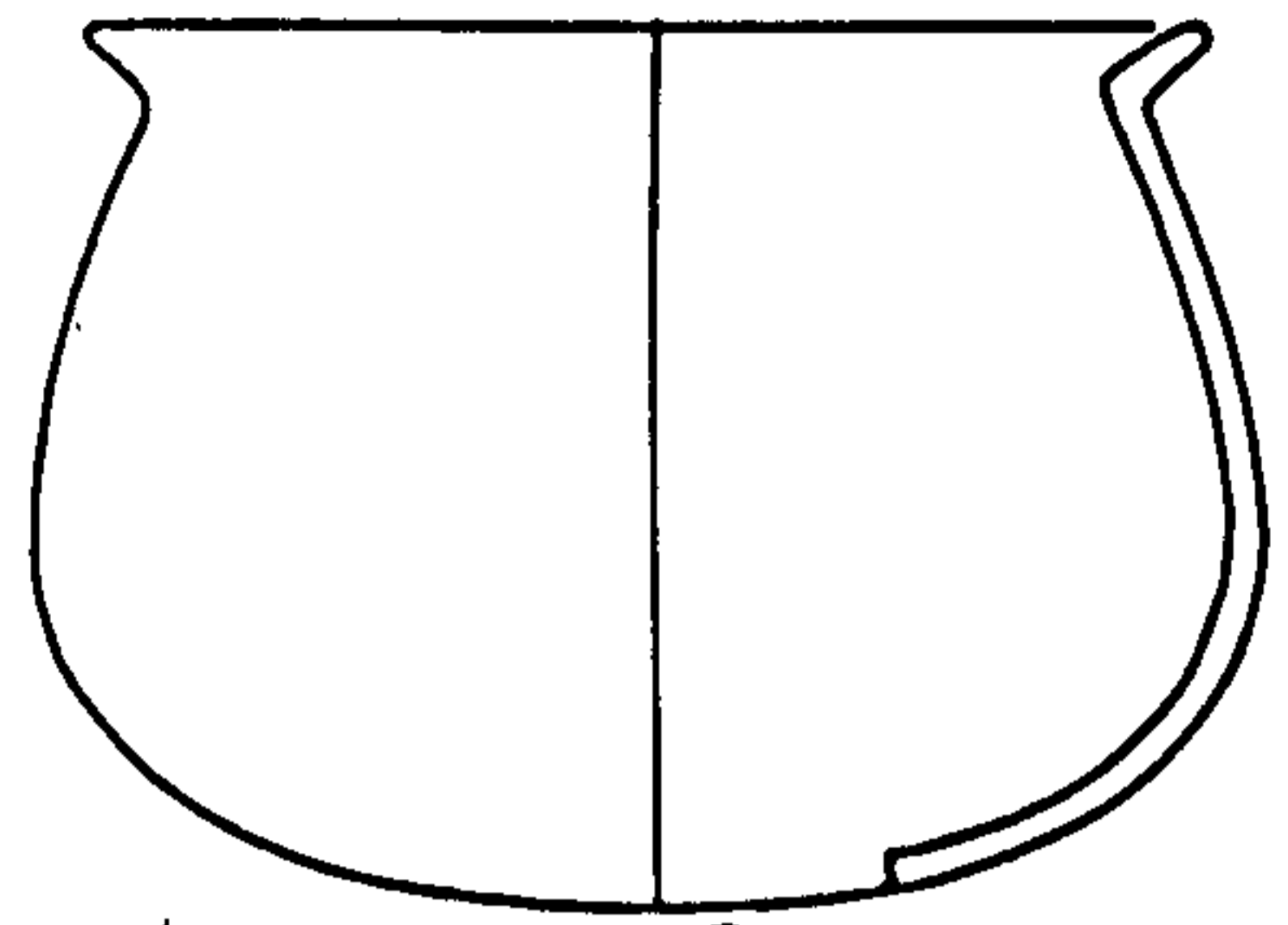

3



4

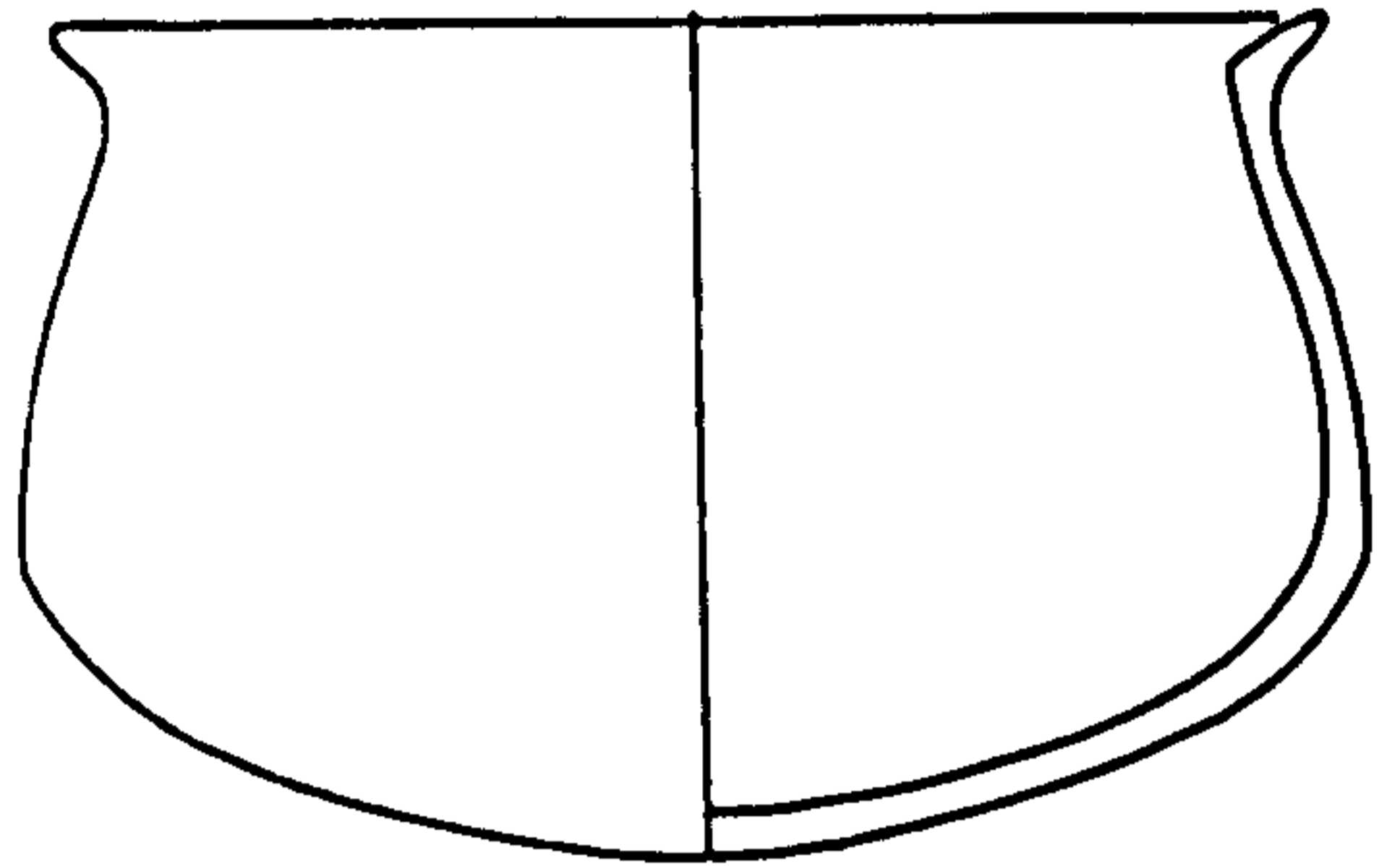

5

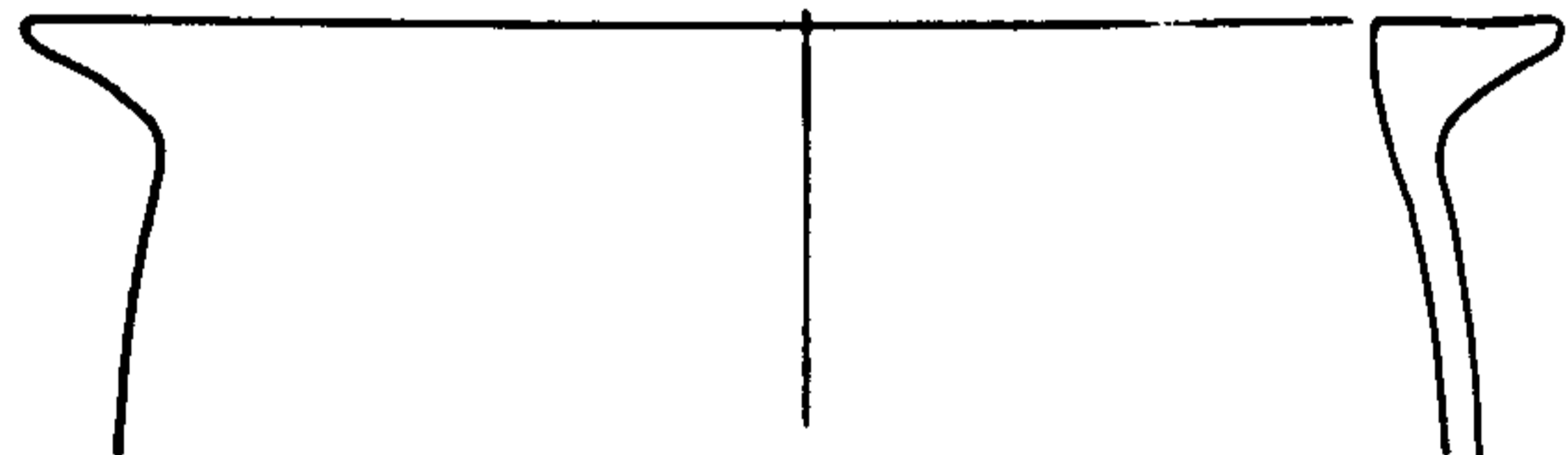

6

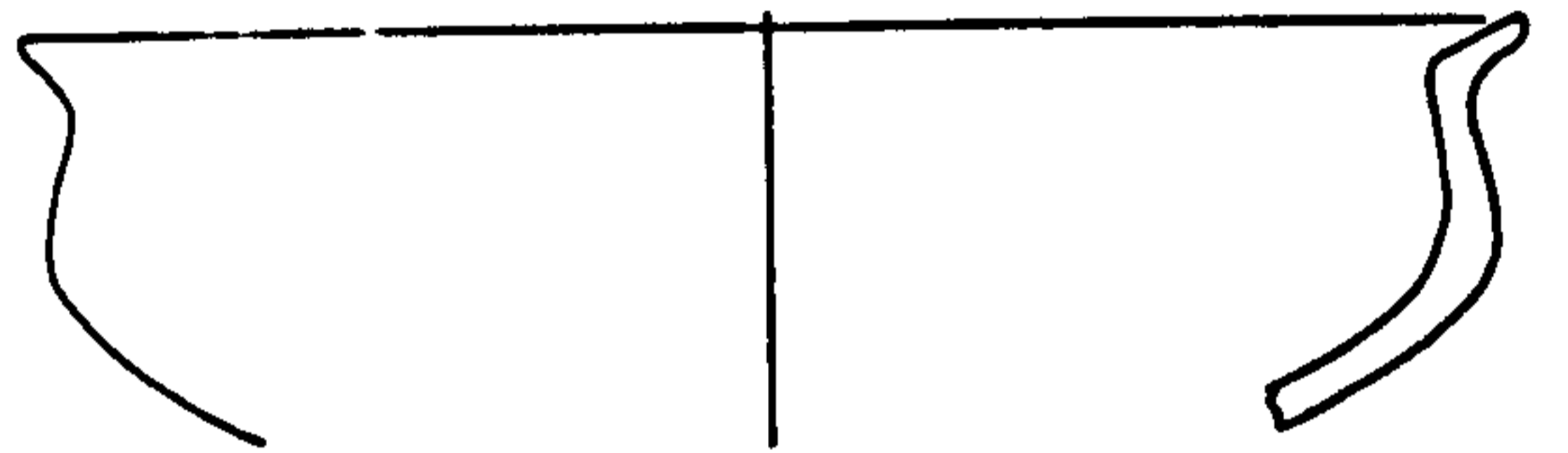

7



8

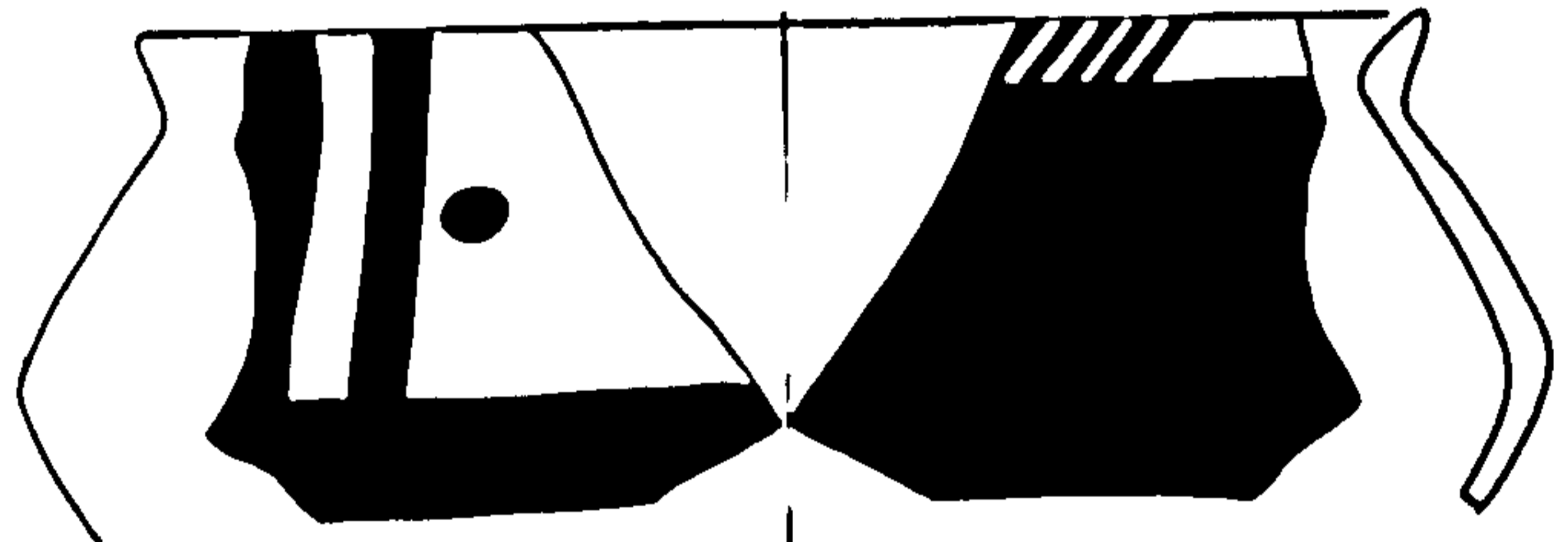

10

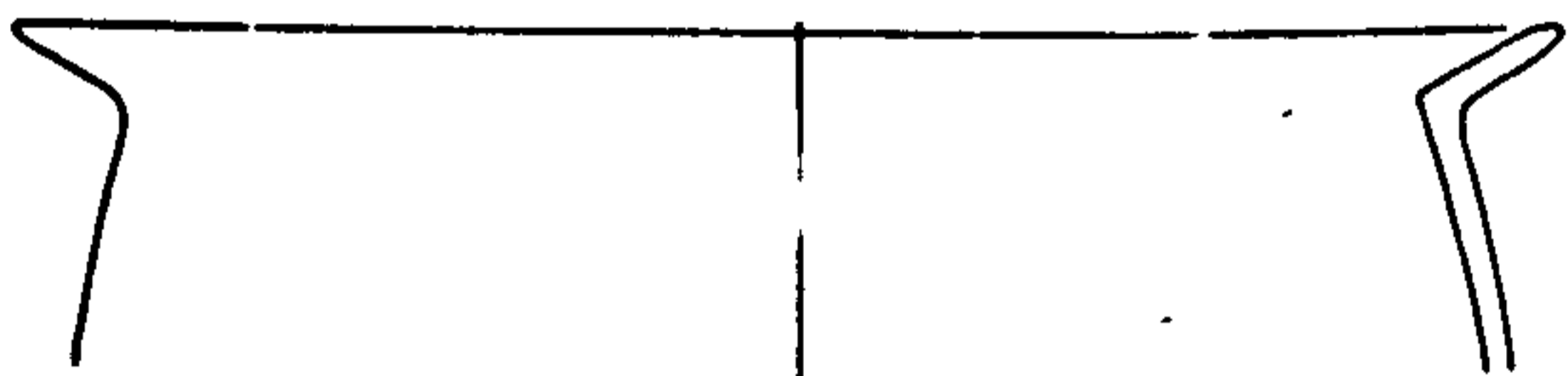

9

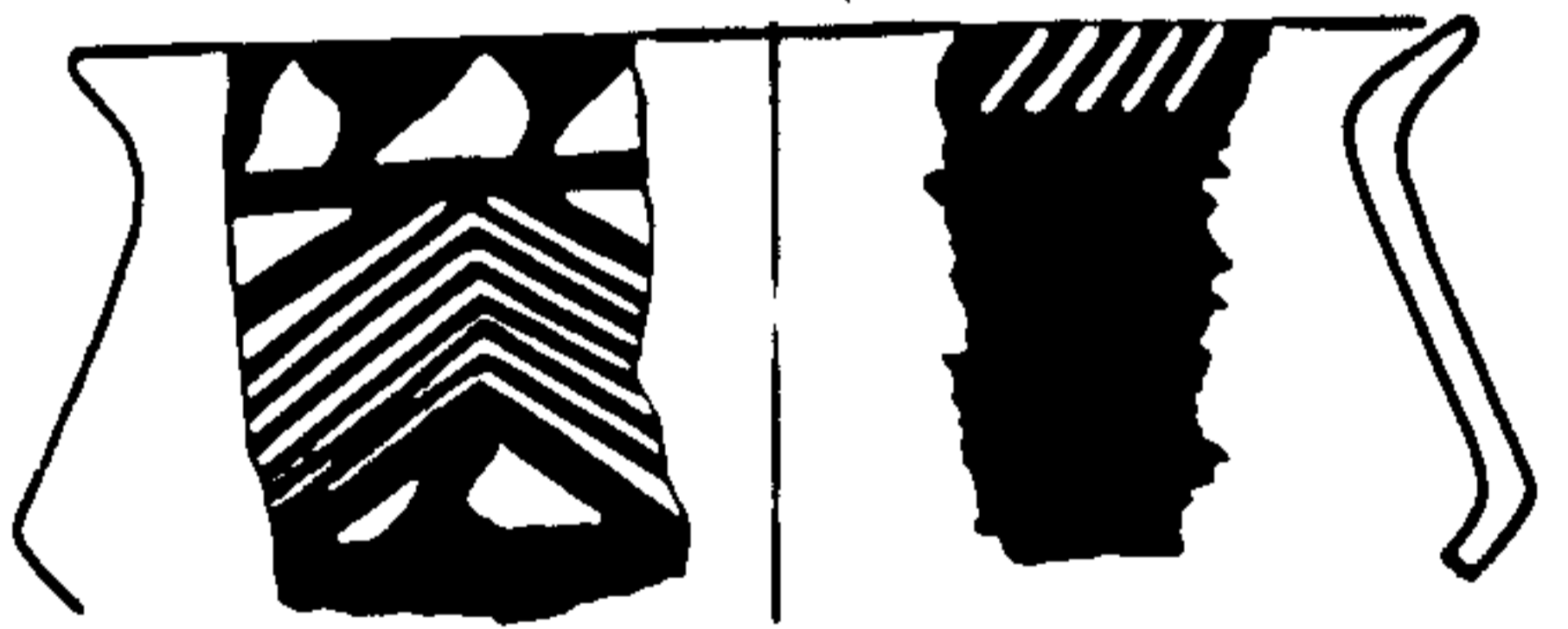

12

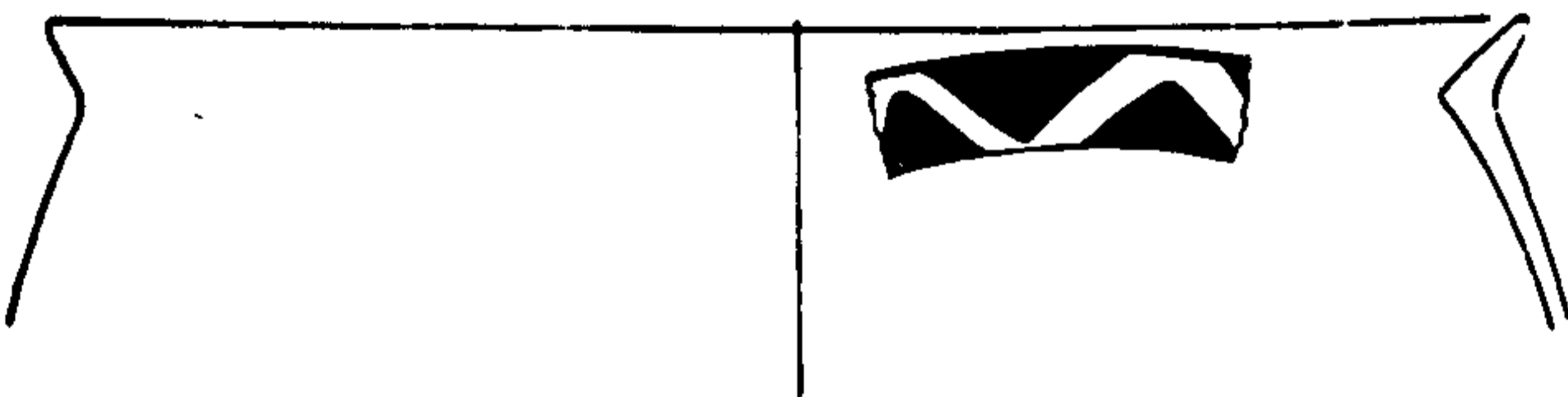

11

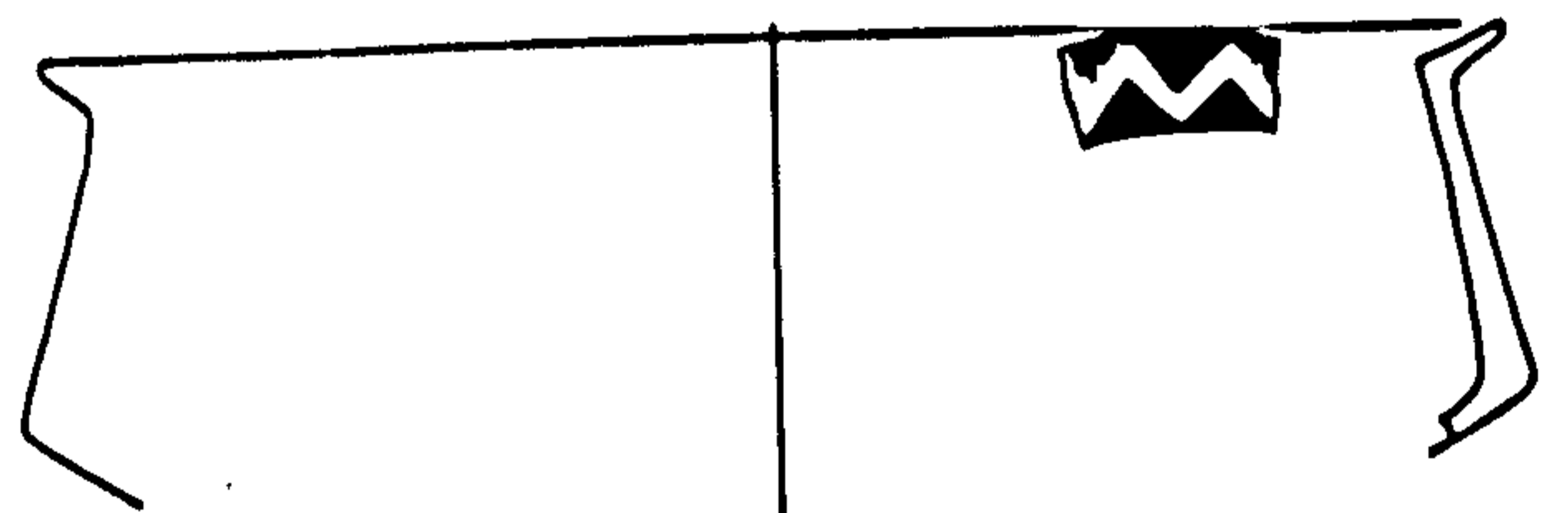

14

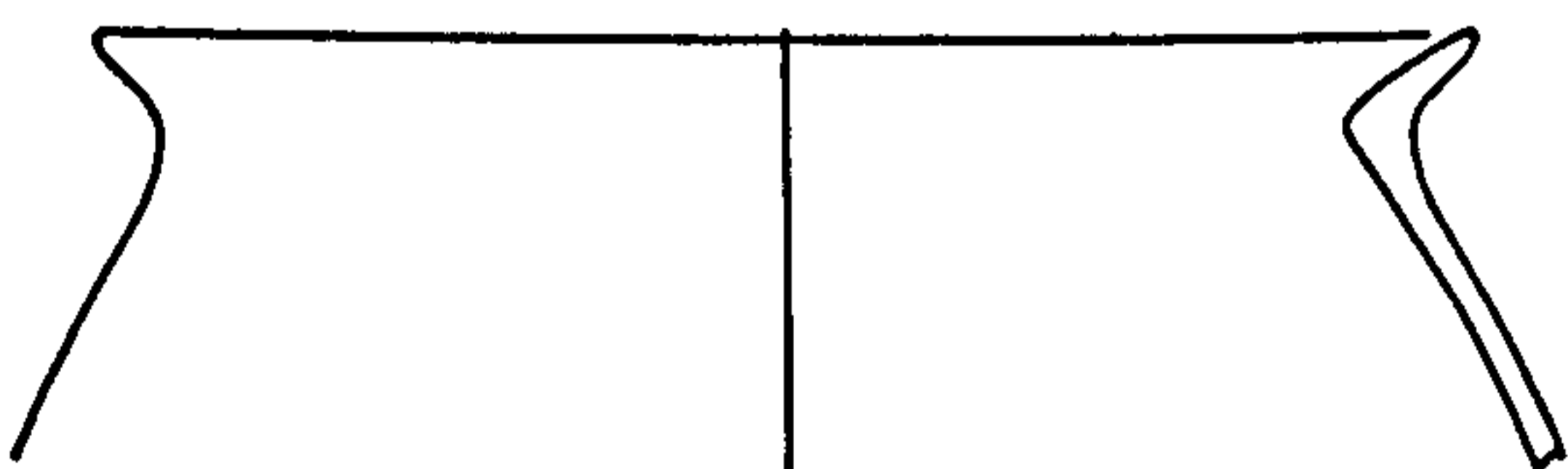

13

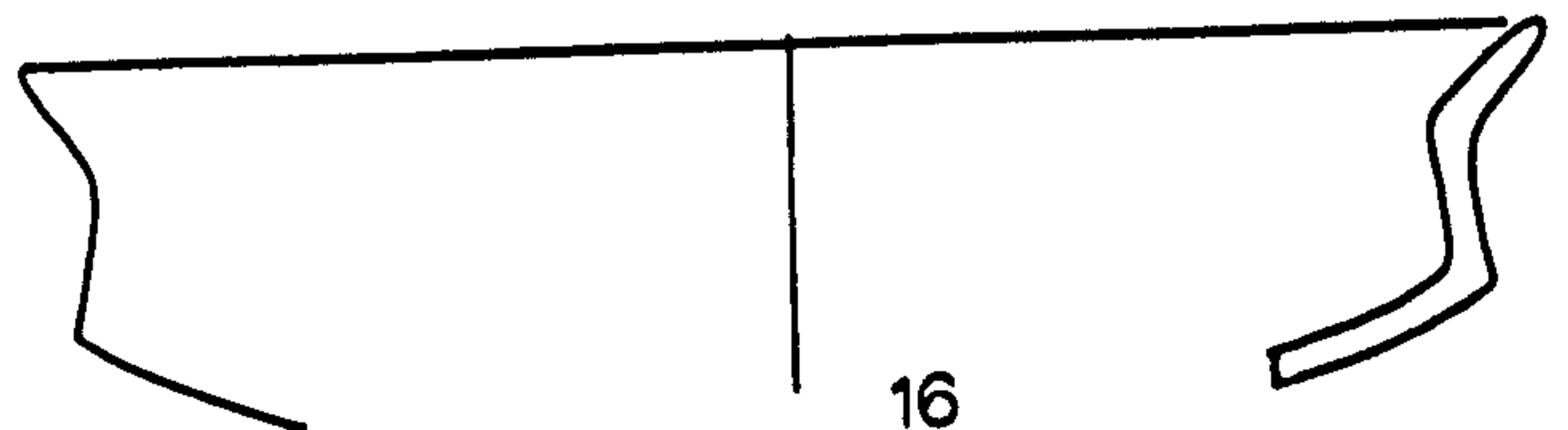

16

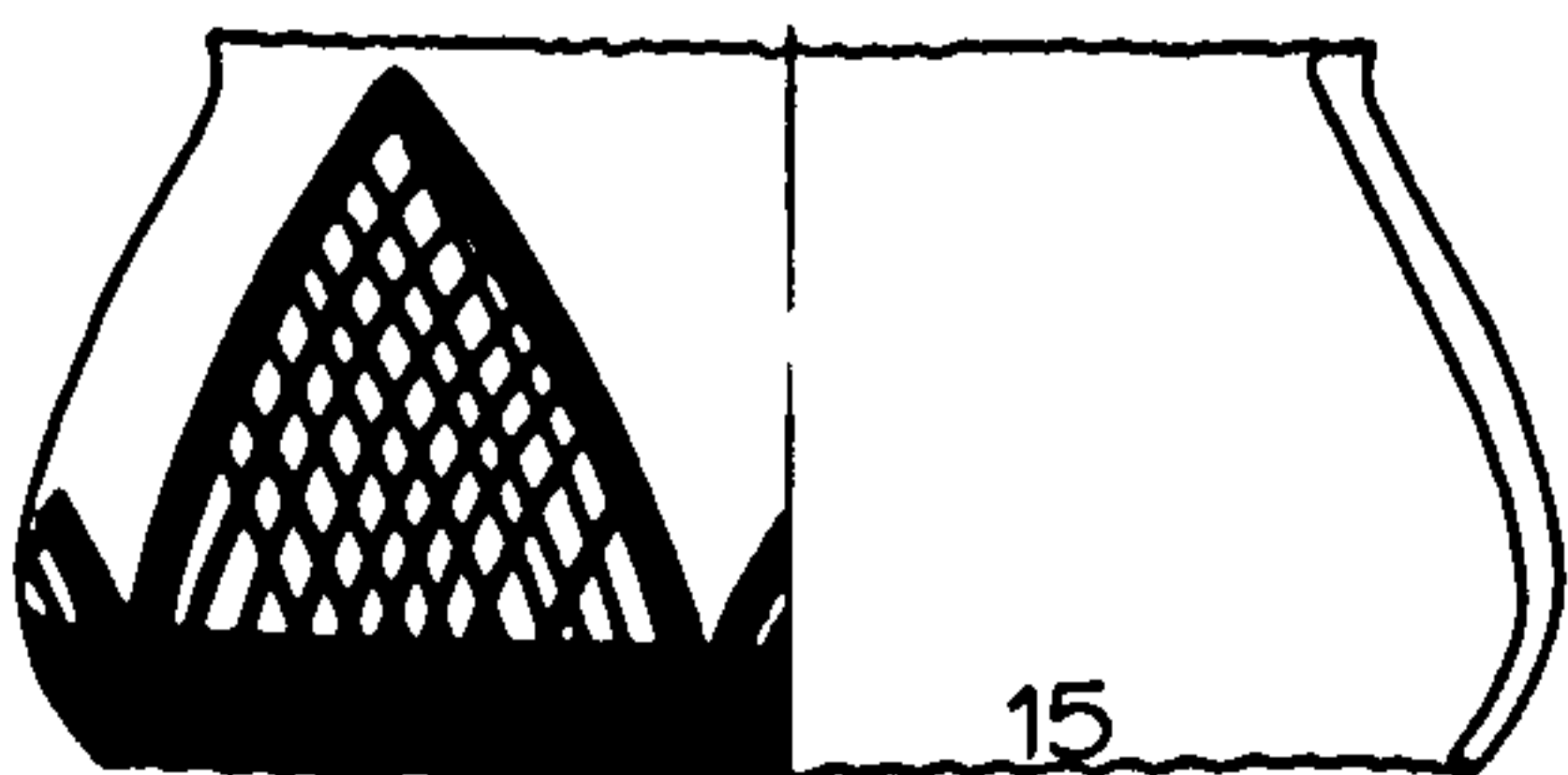

15

Fig 18

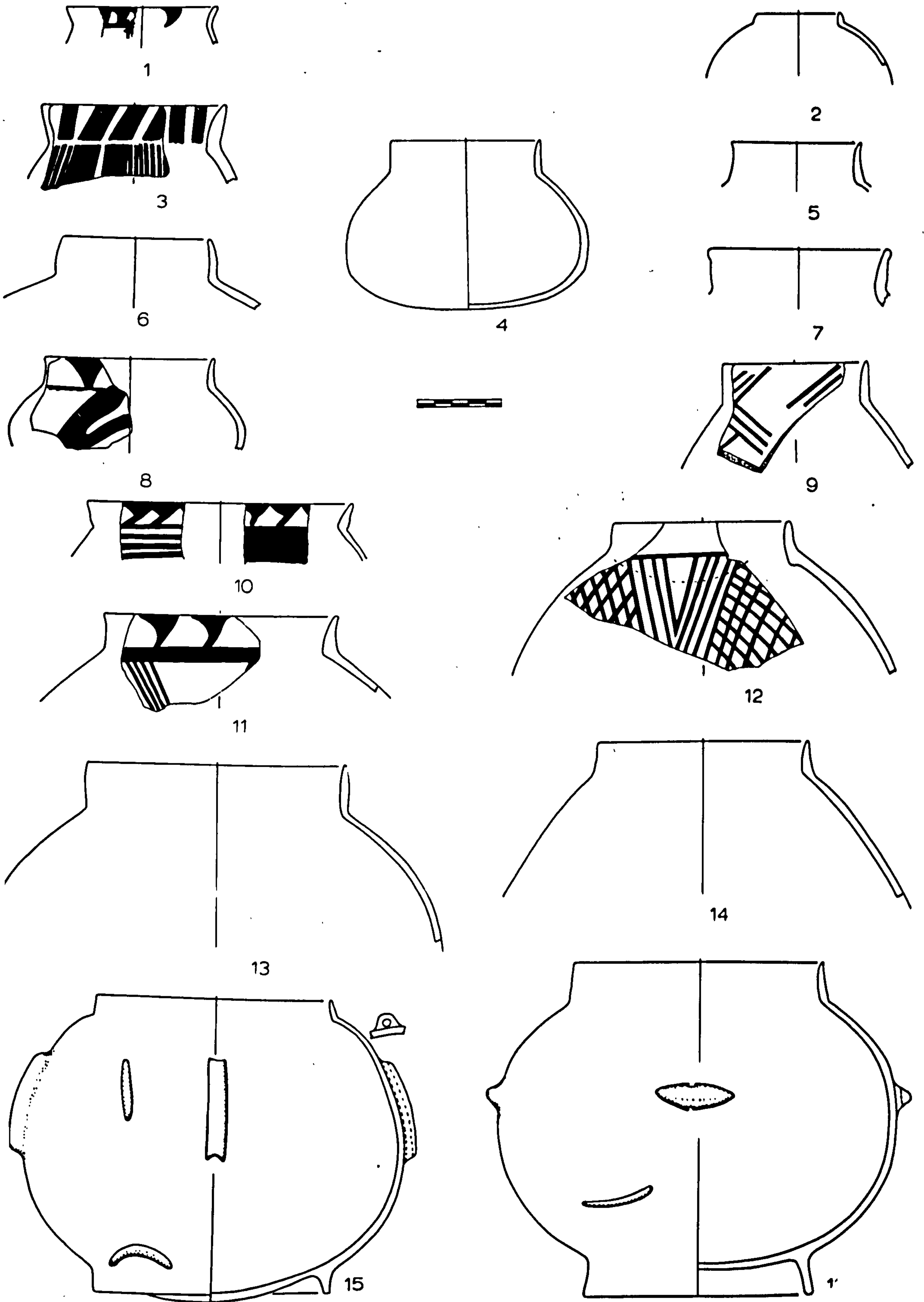

Fig 19

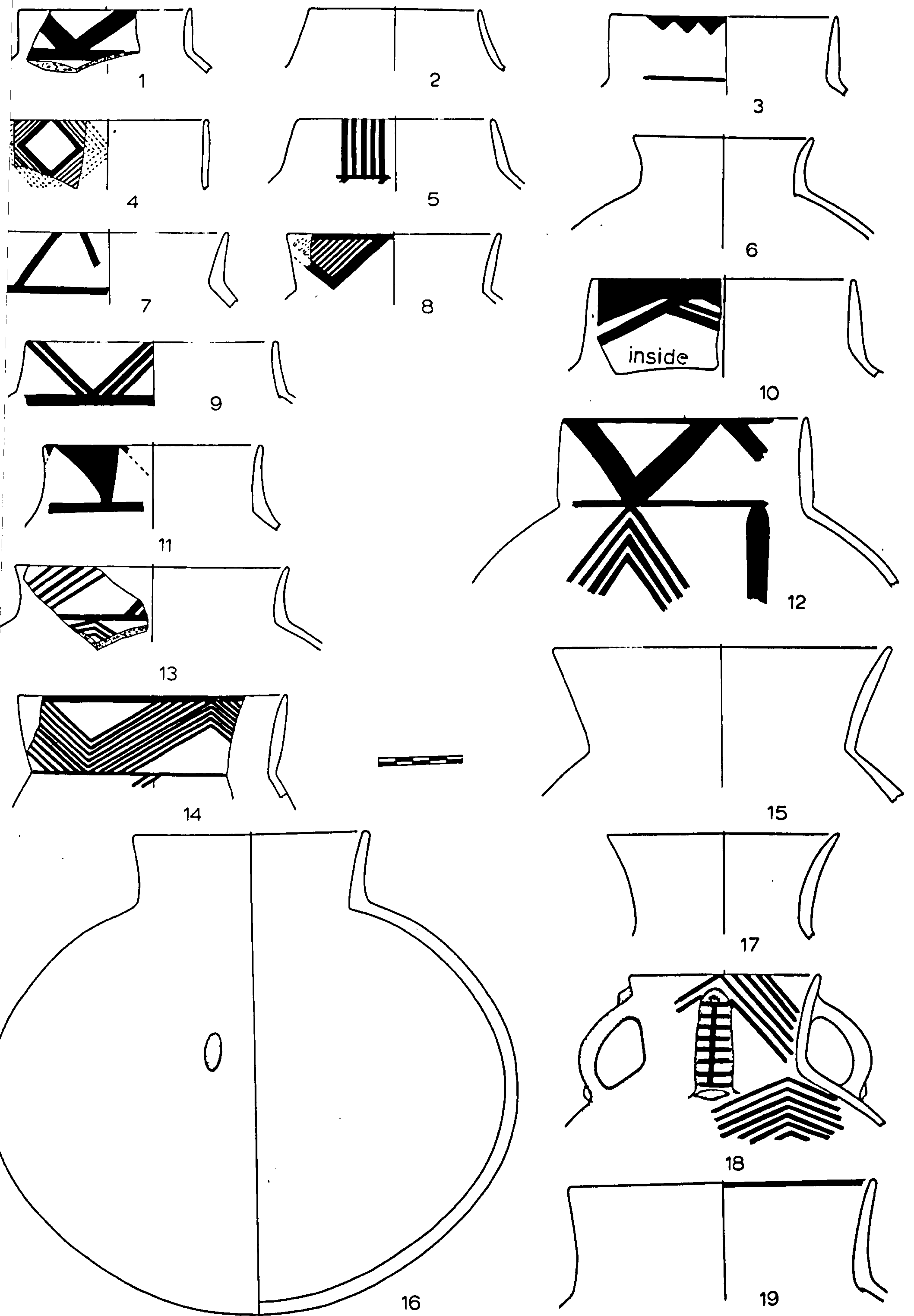

Fig 20



Fig 21

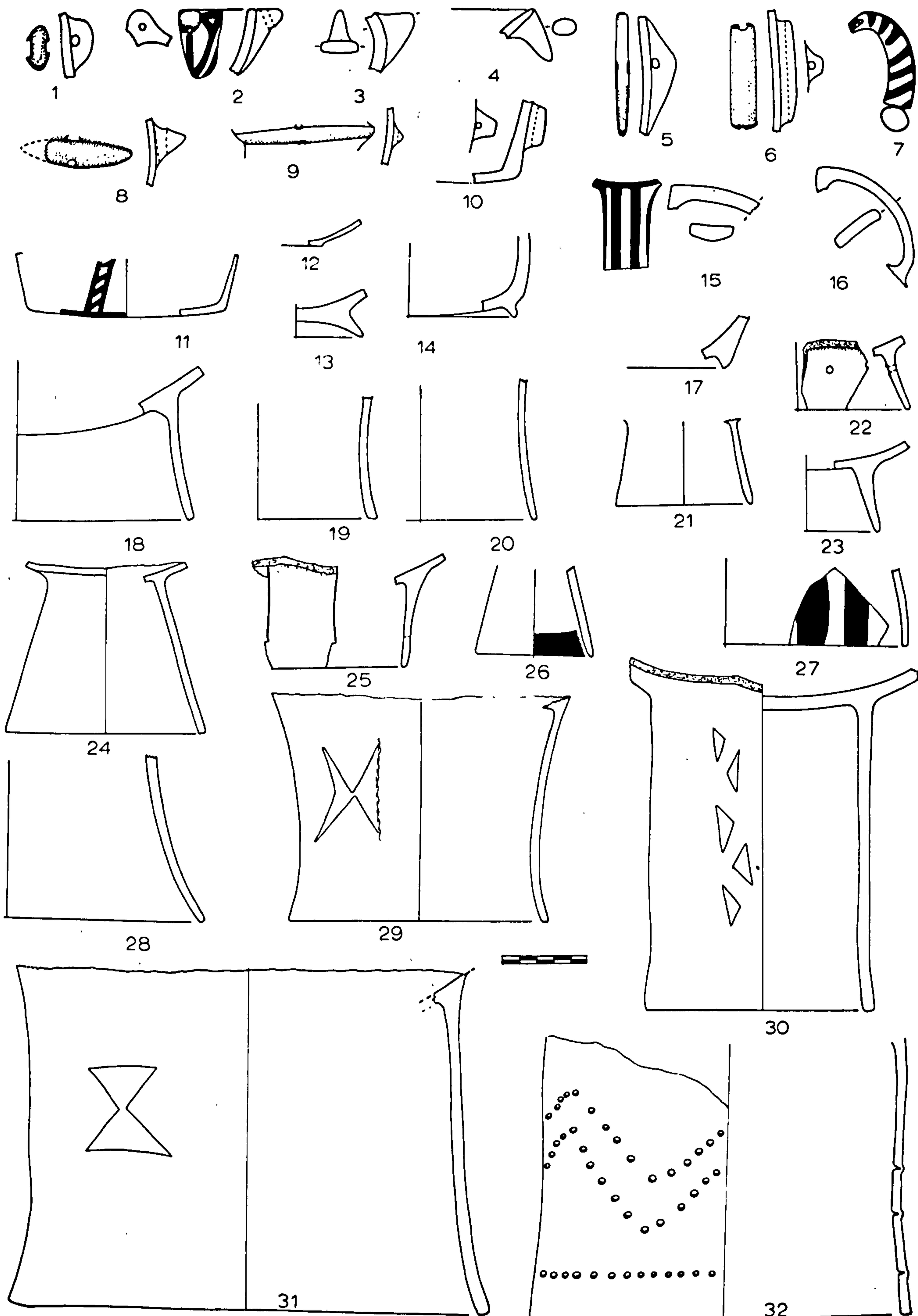

Fig 22

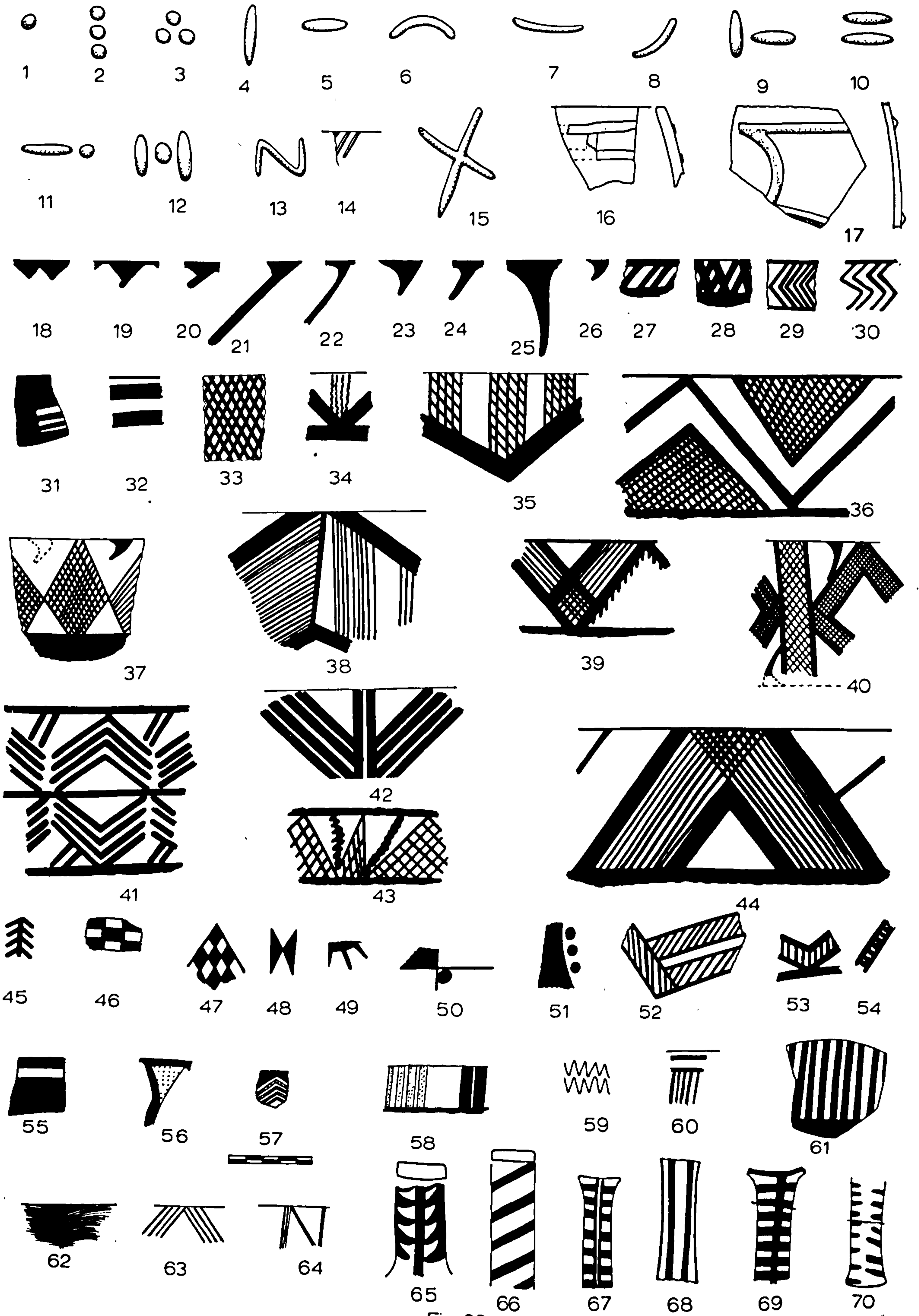
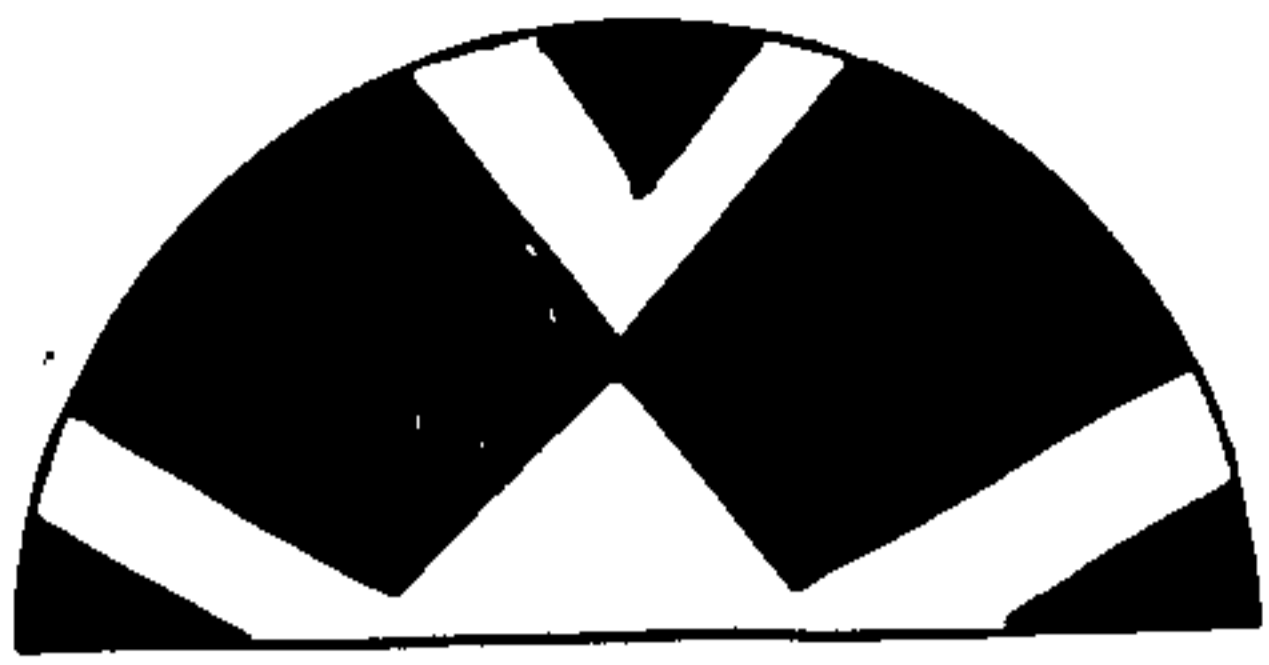
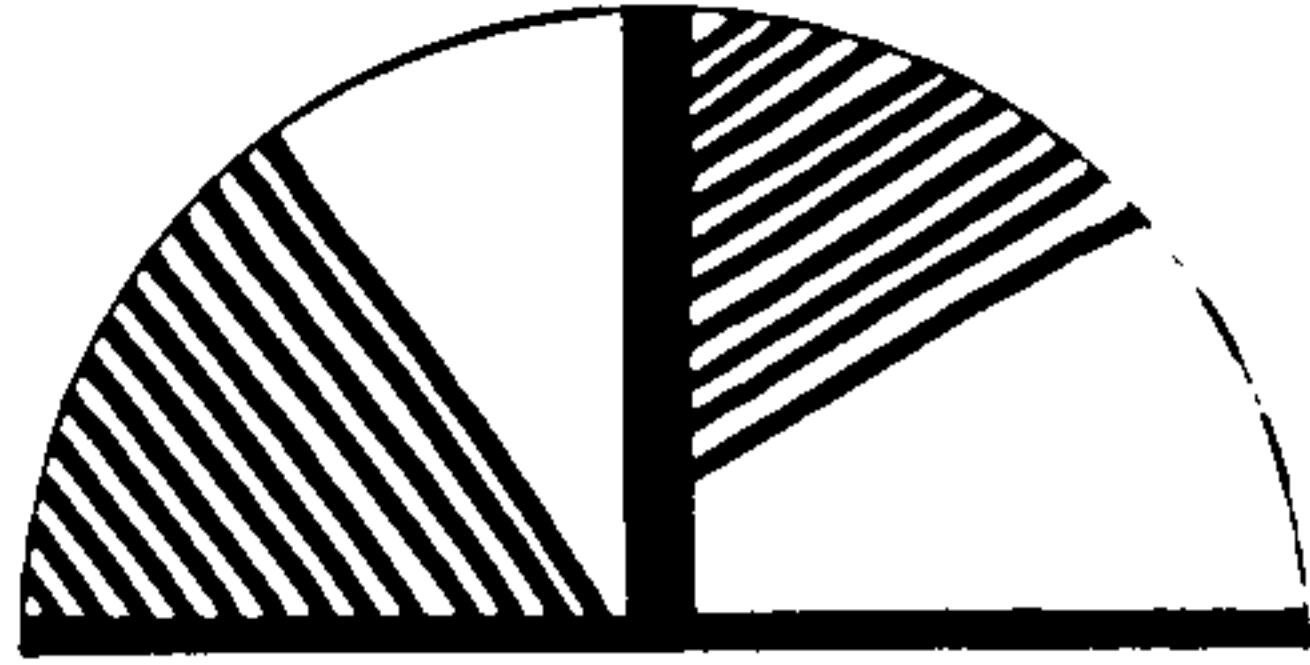

Fig: 23



1



2

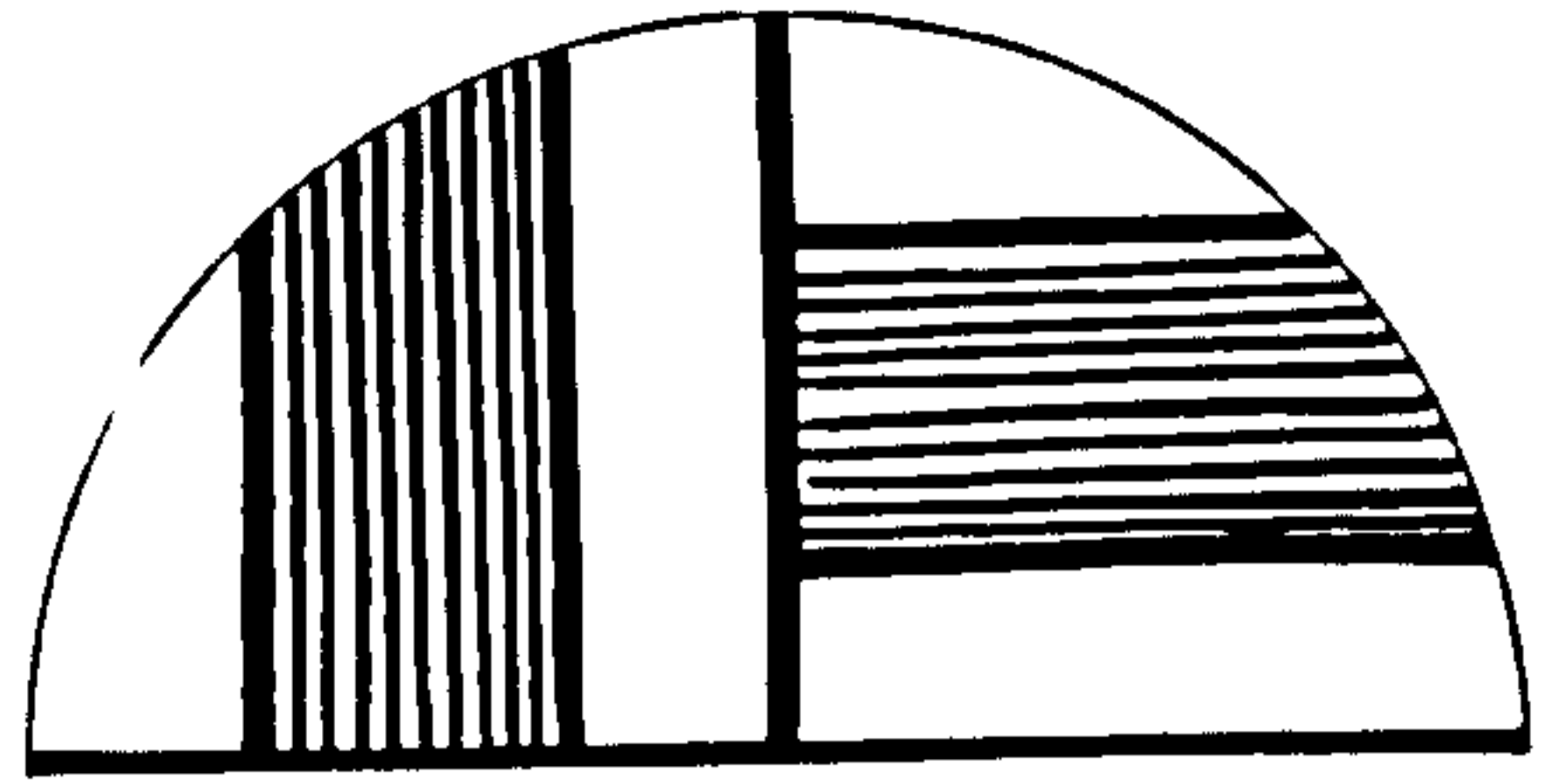

3

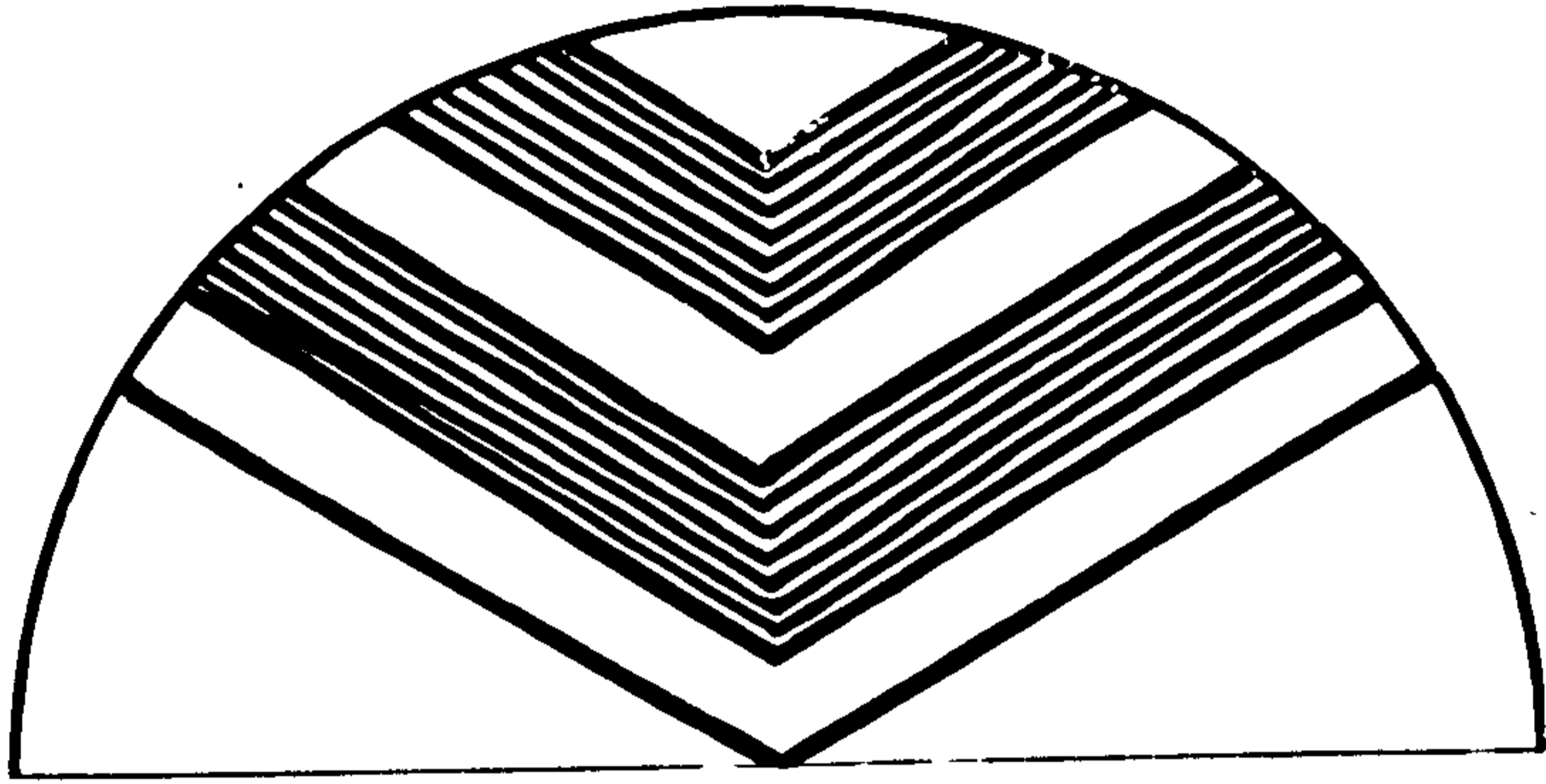

4

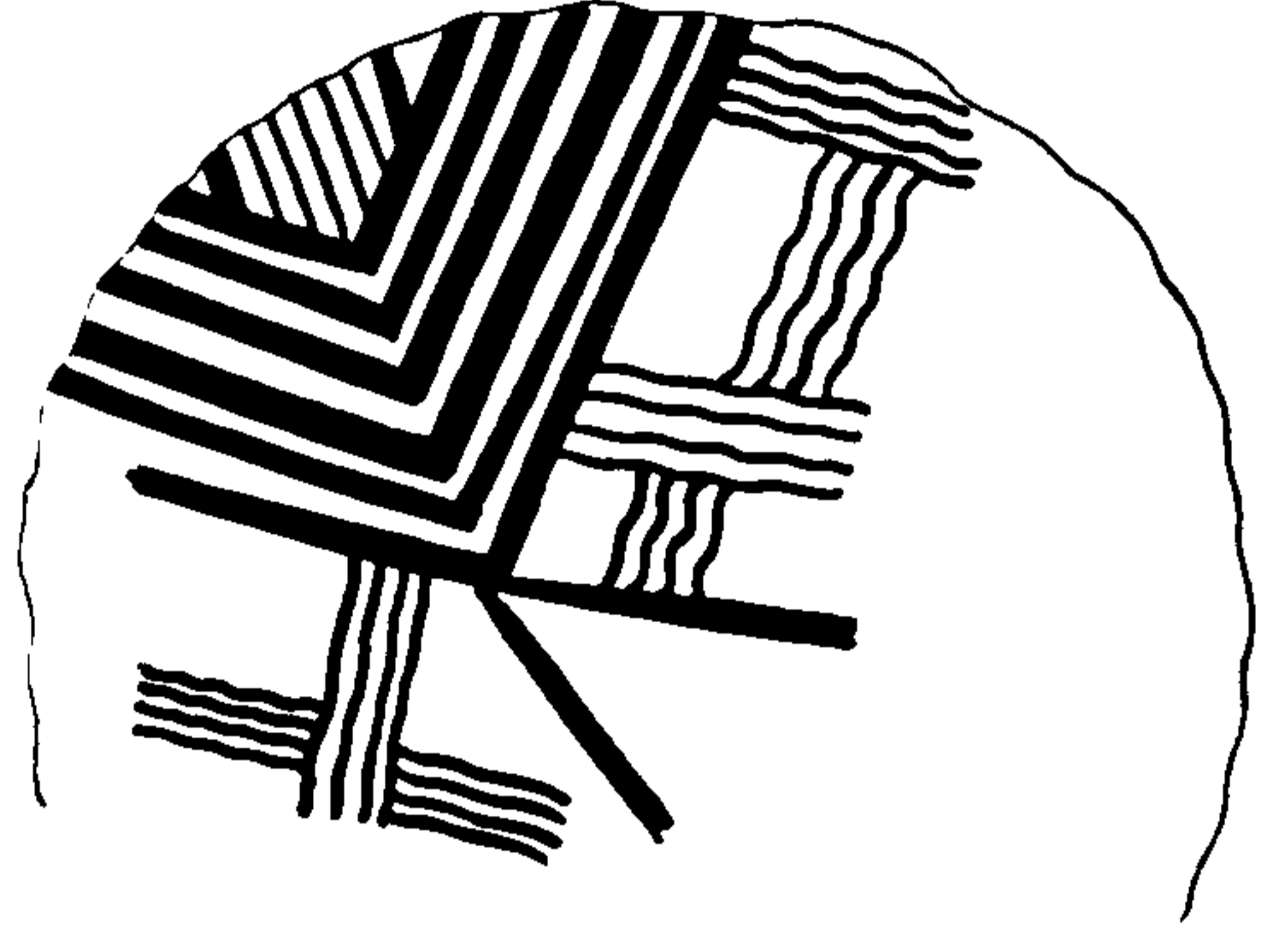

5

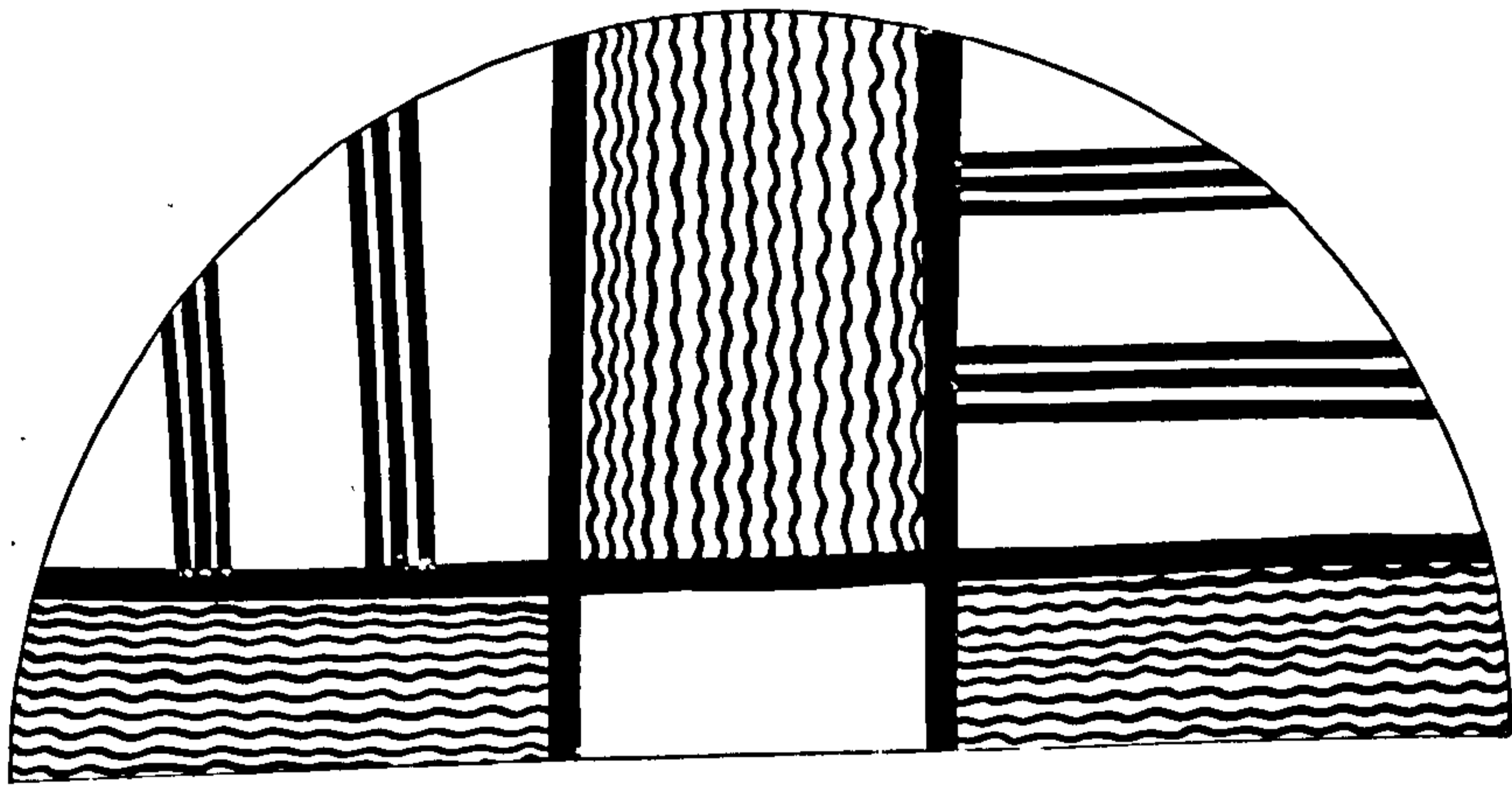

6

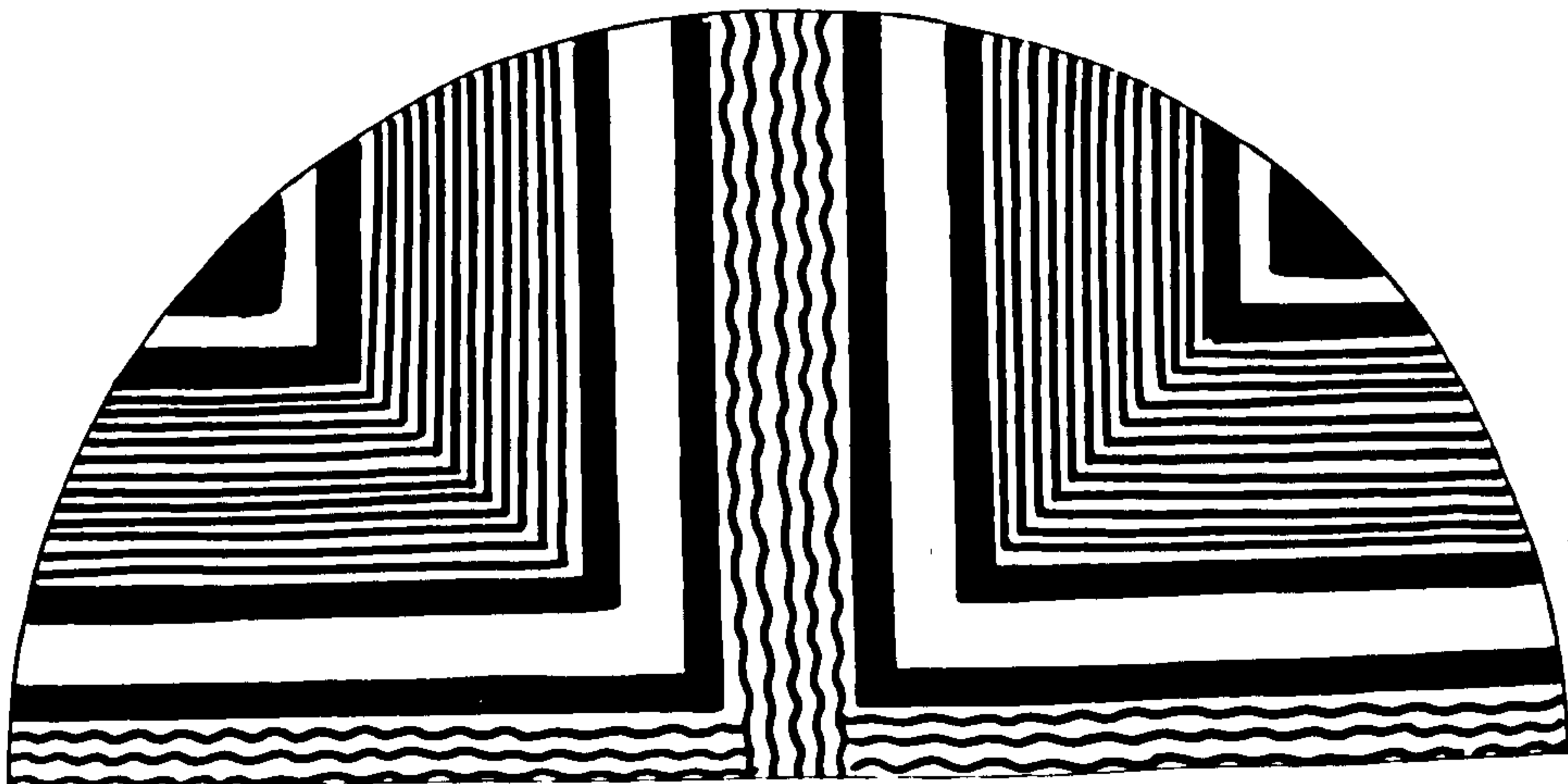

7

Fig 24

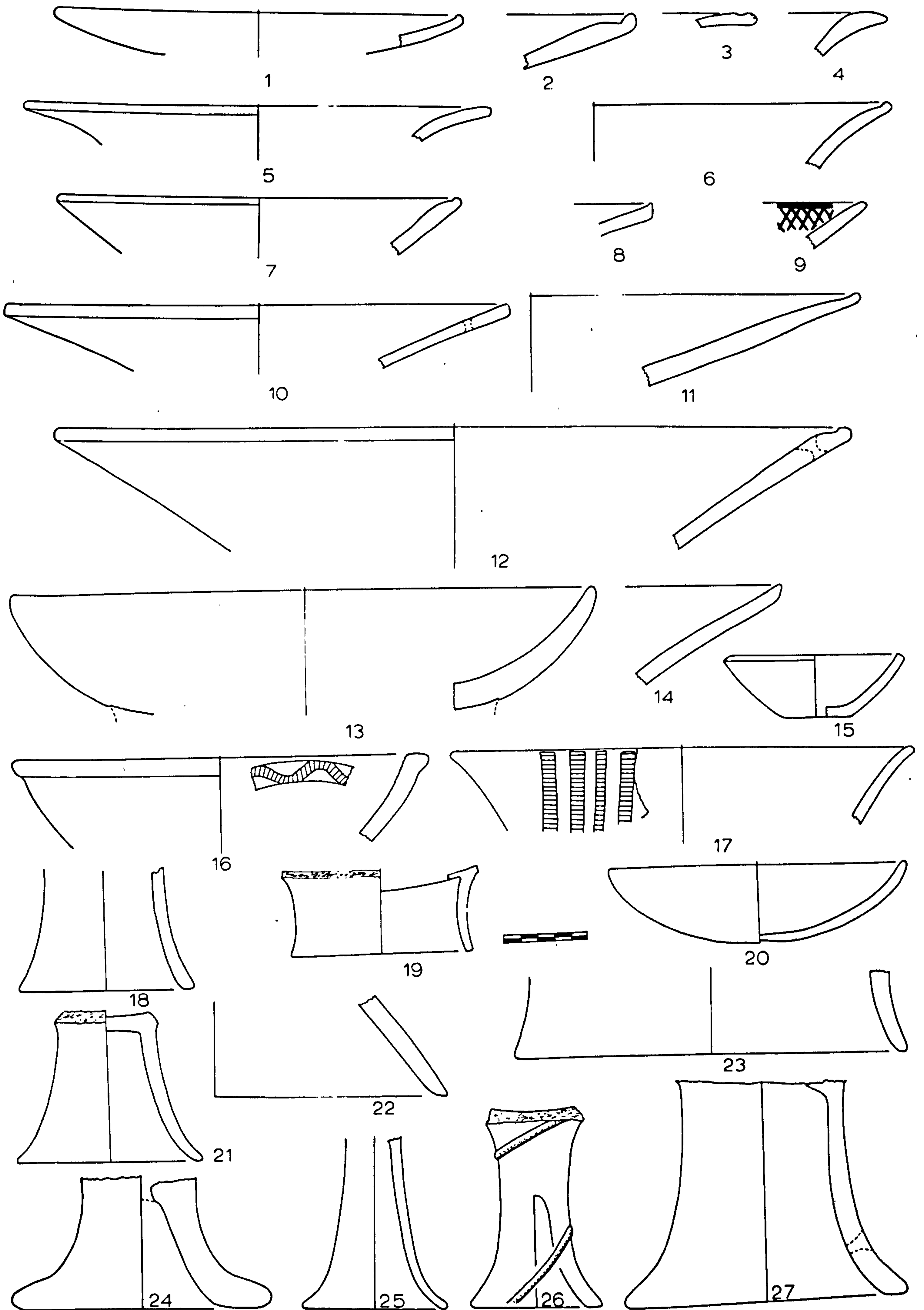

Fig 25

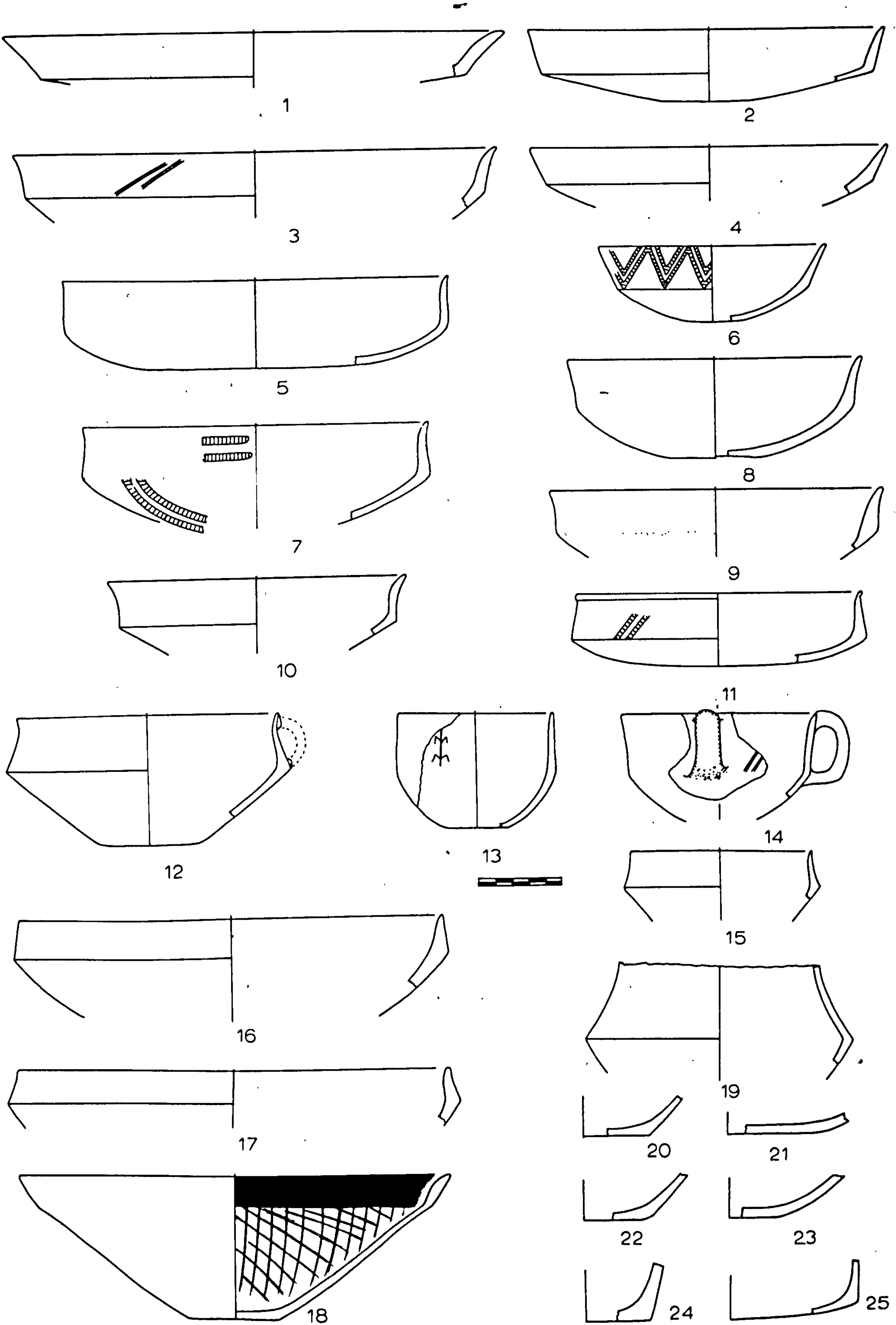

Fig 26

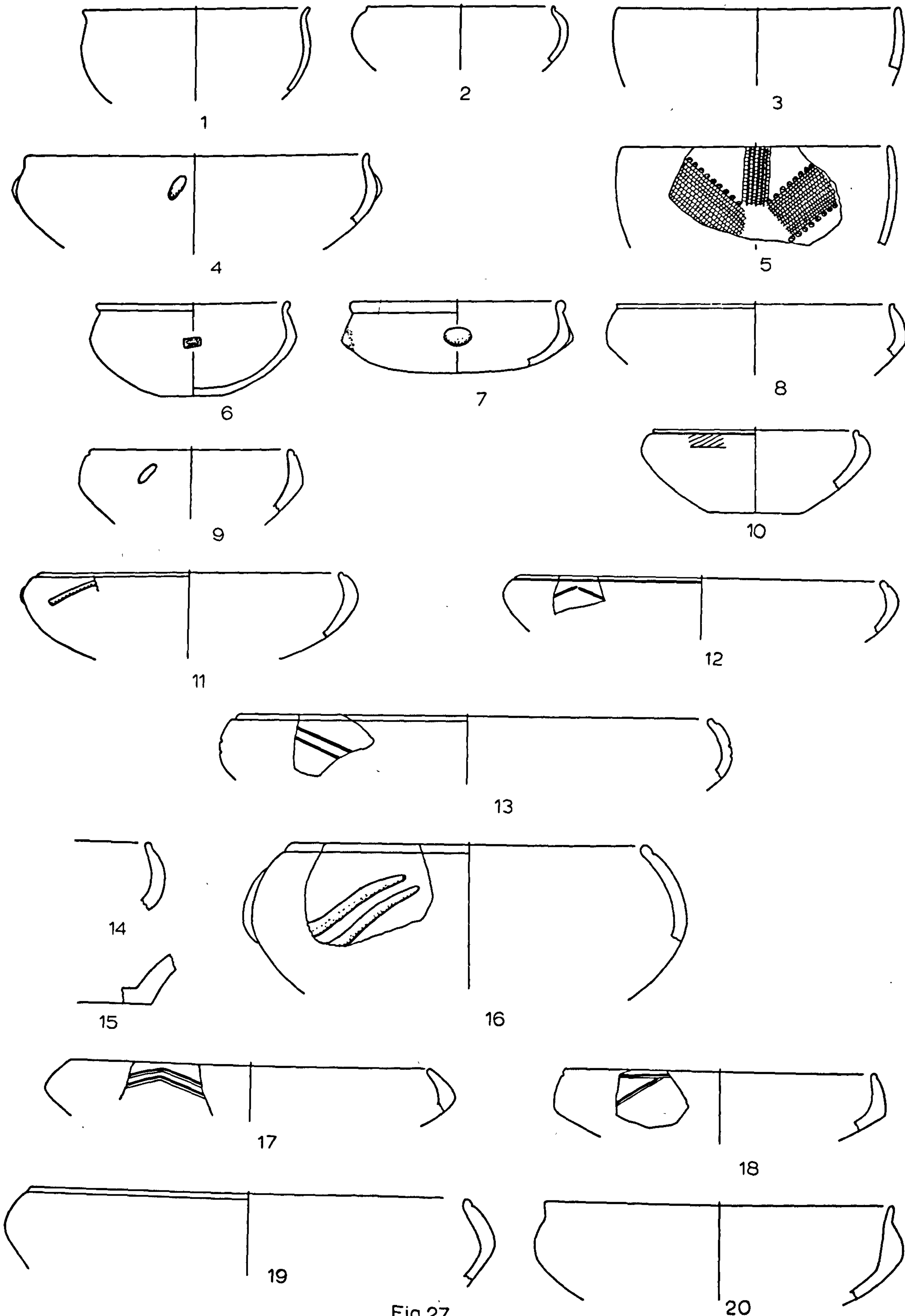

Fig 27

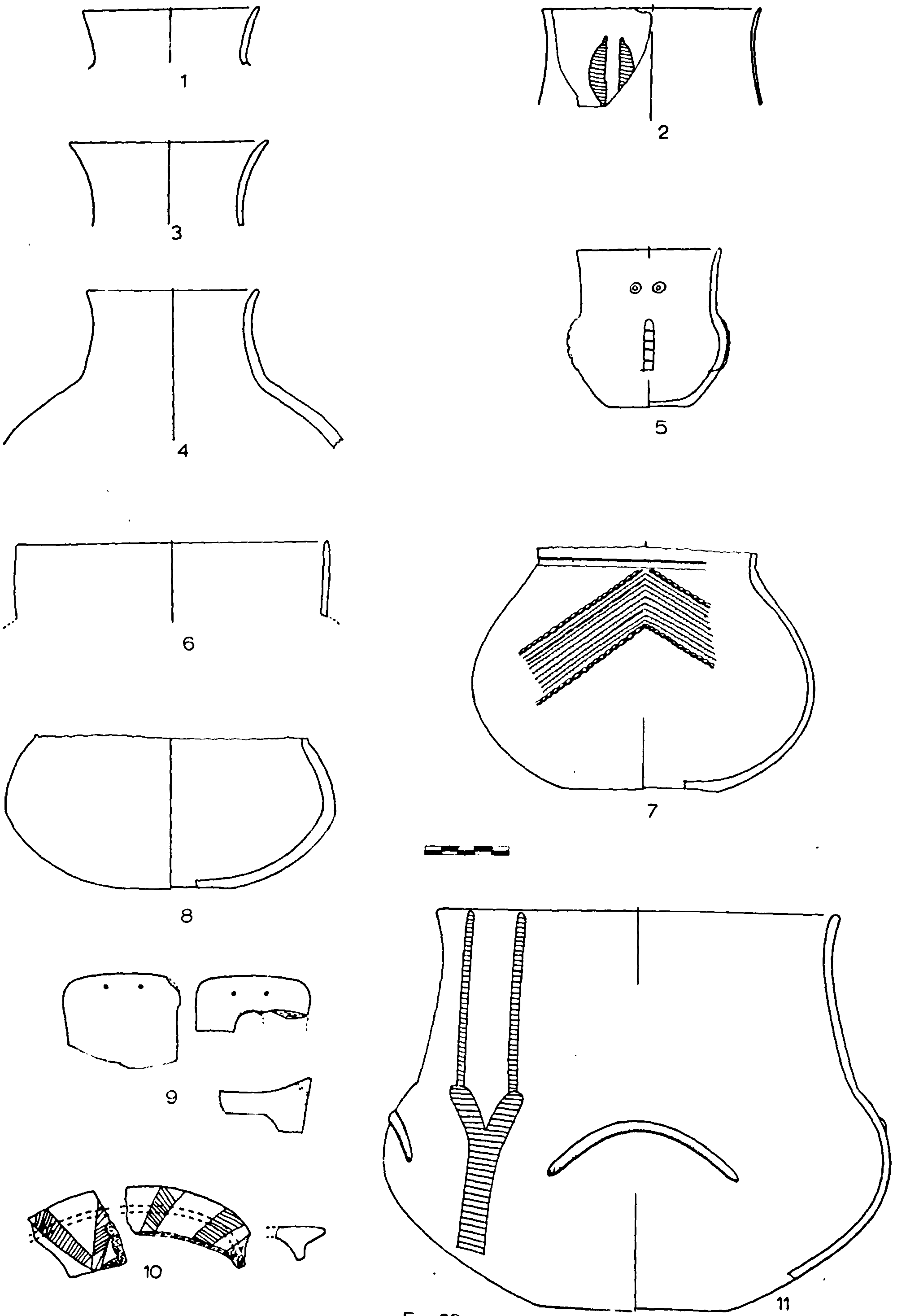
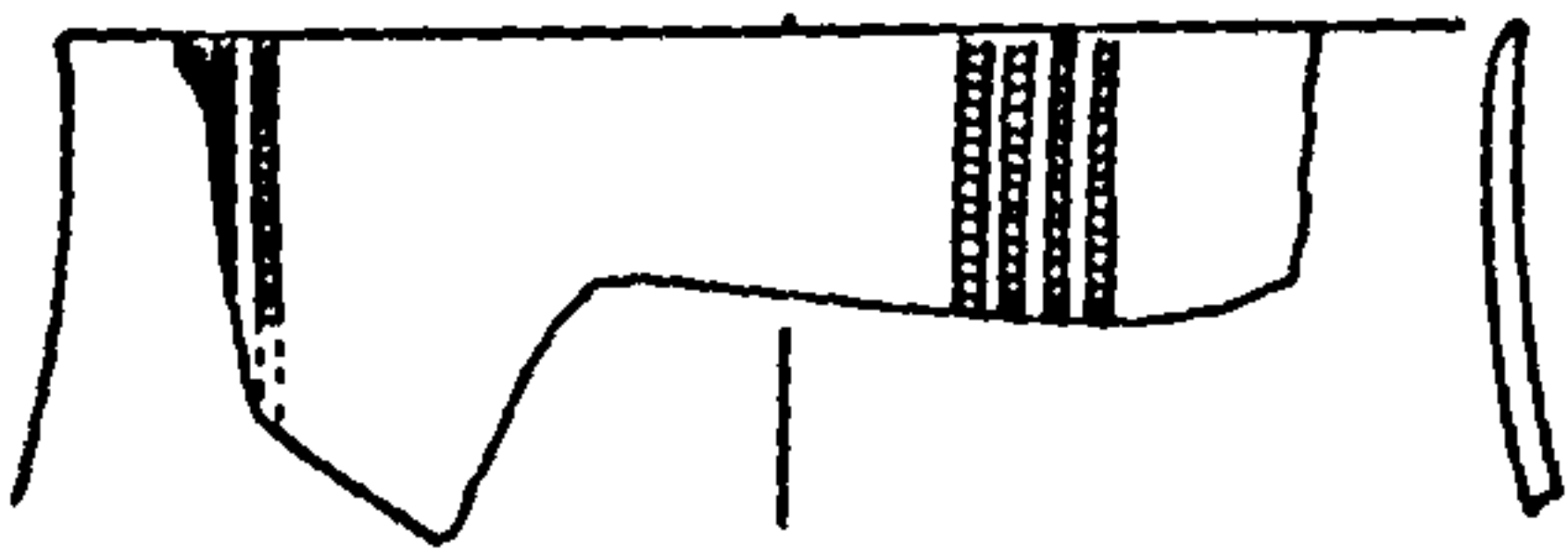
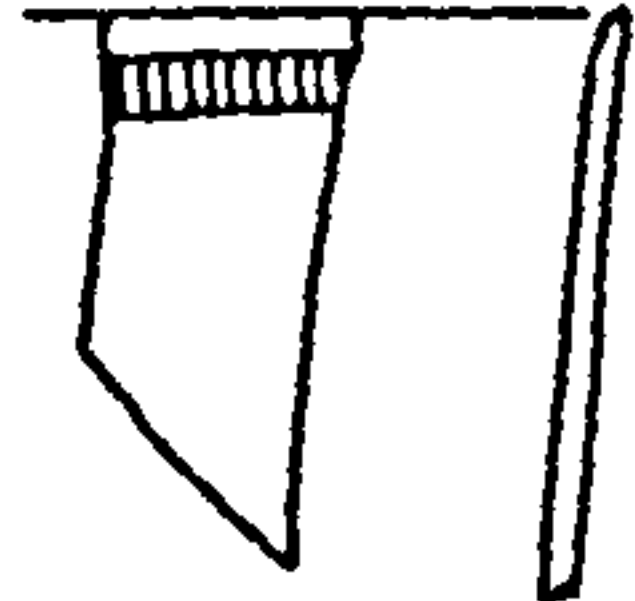

Fig 28



1



2

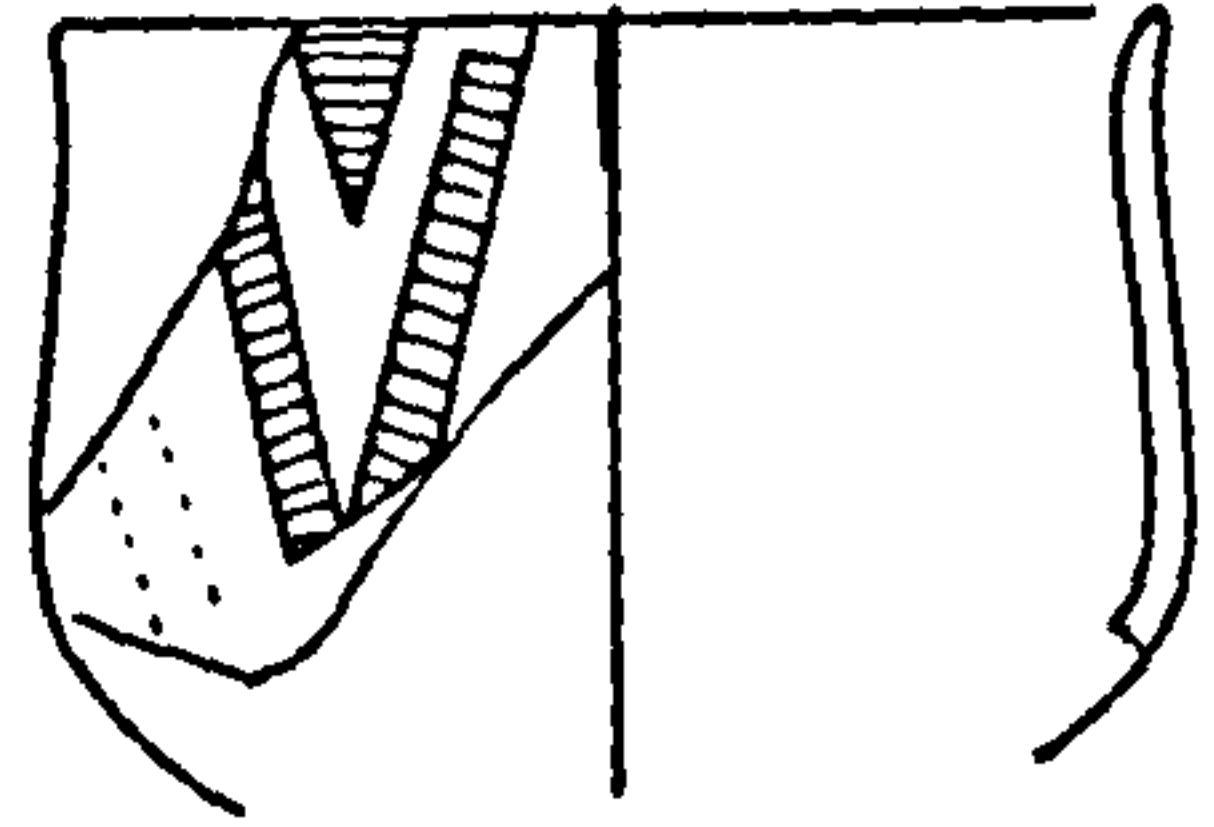

3

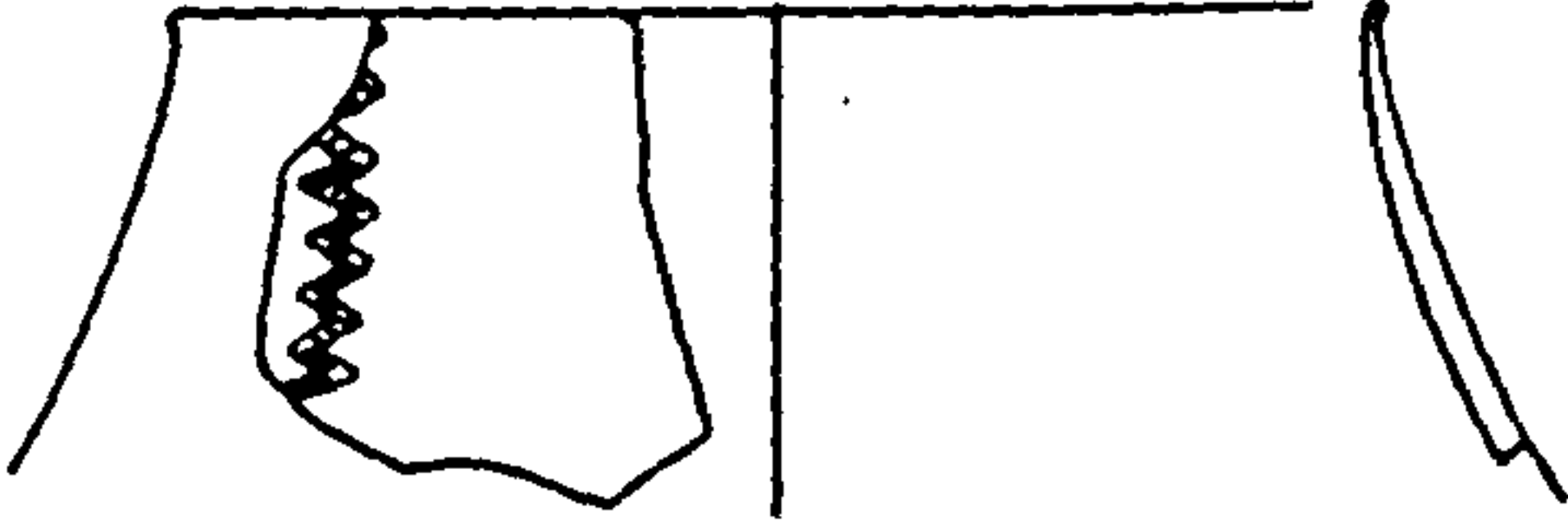

4

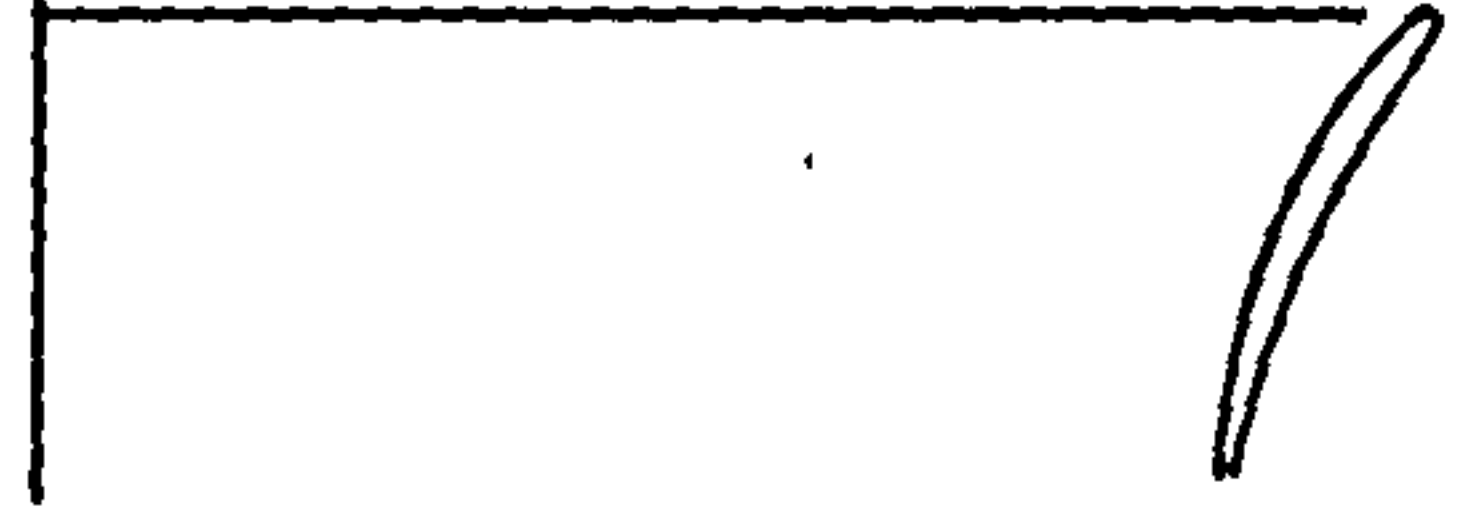

5



6

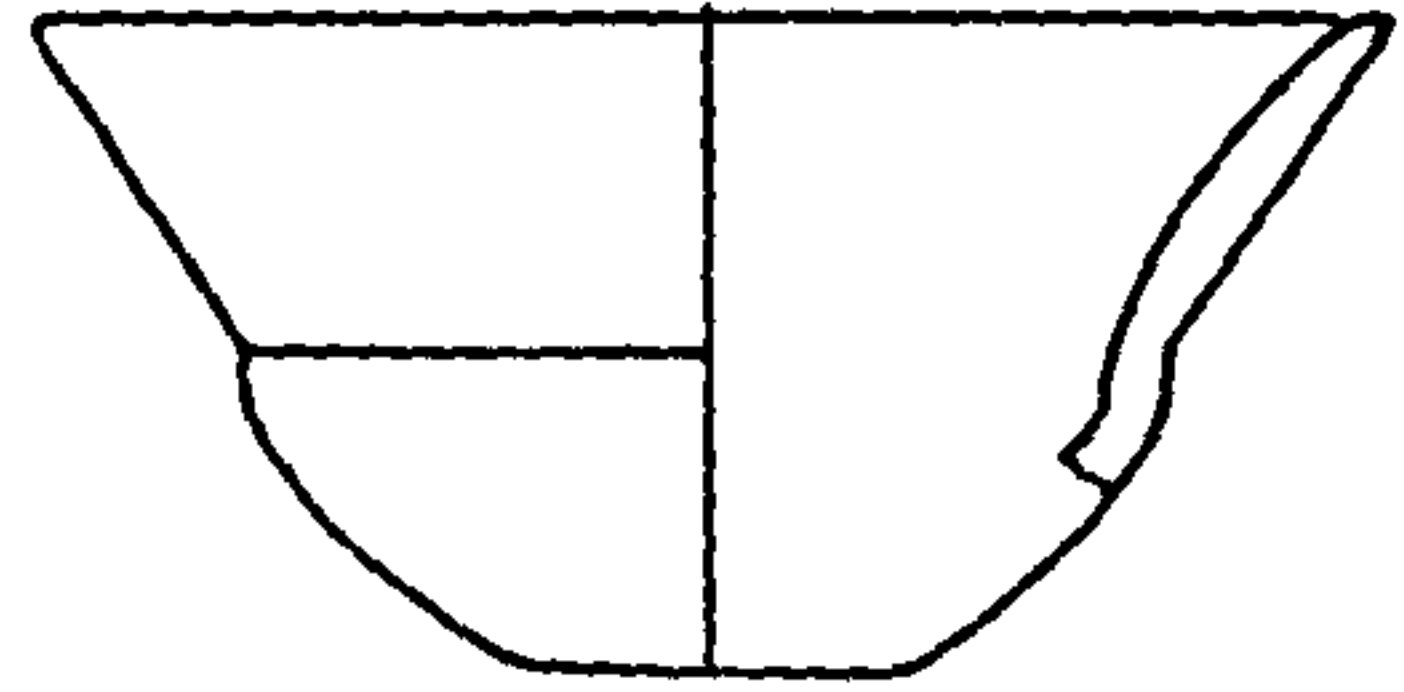

7

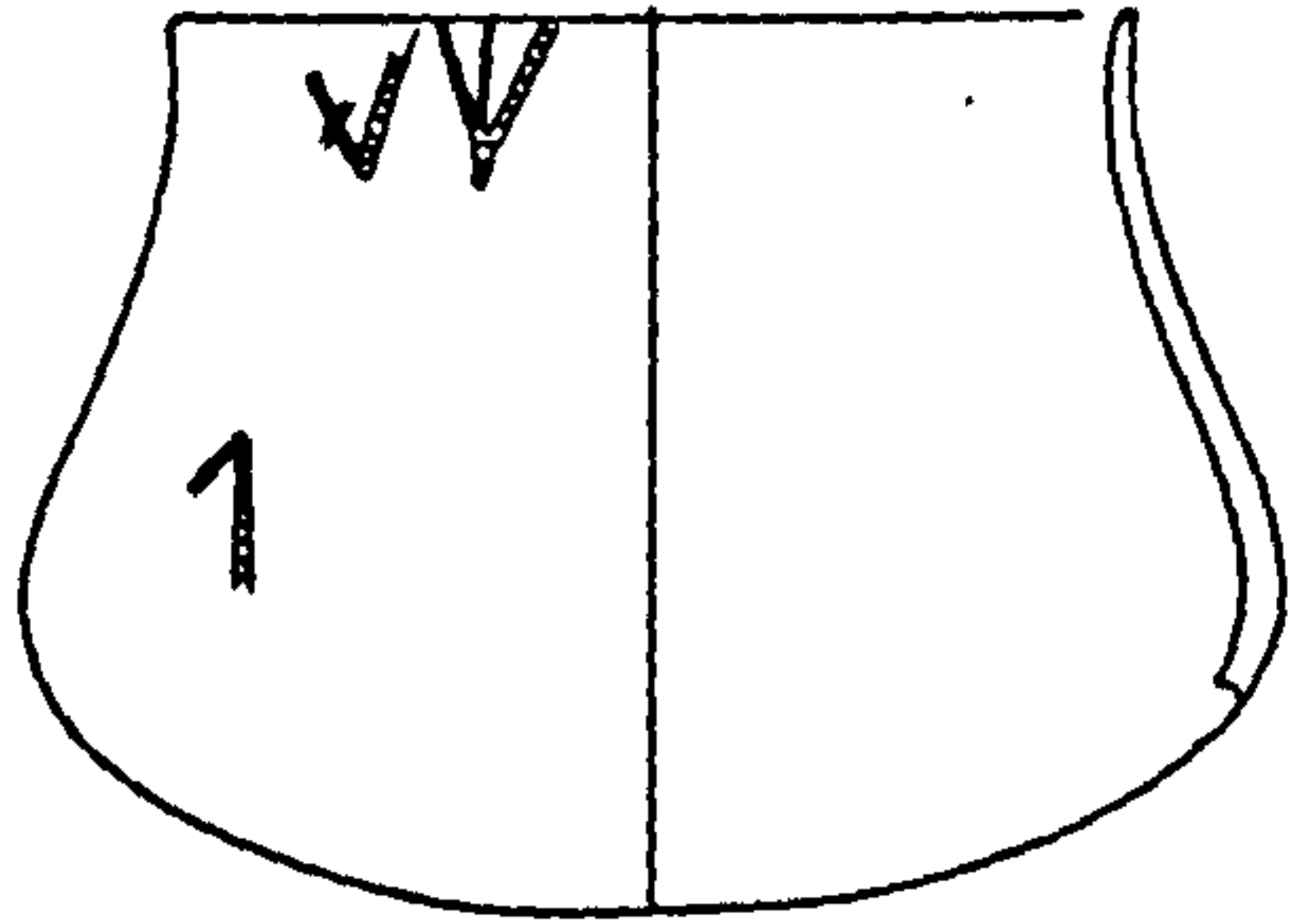

8

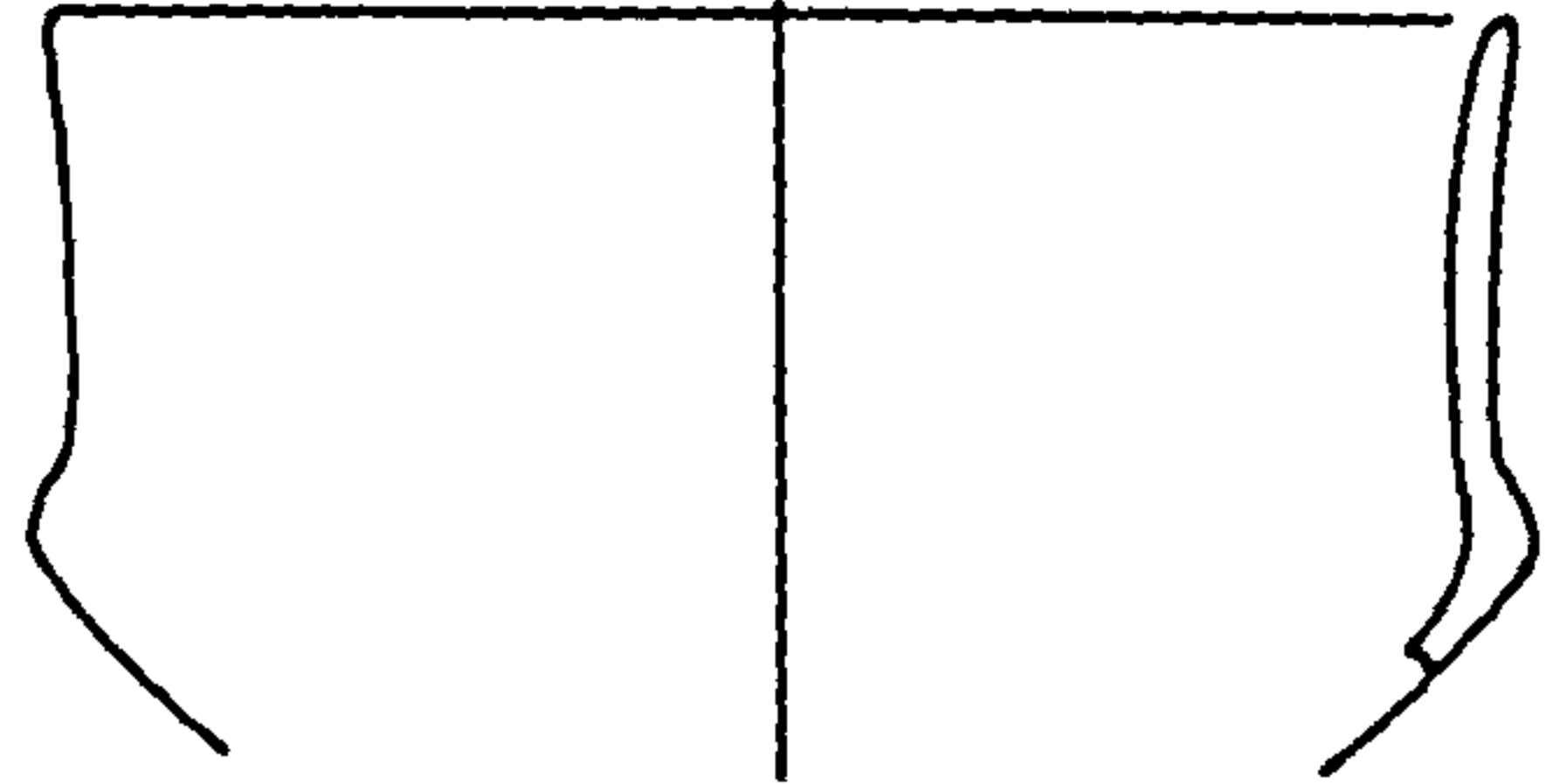

9

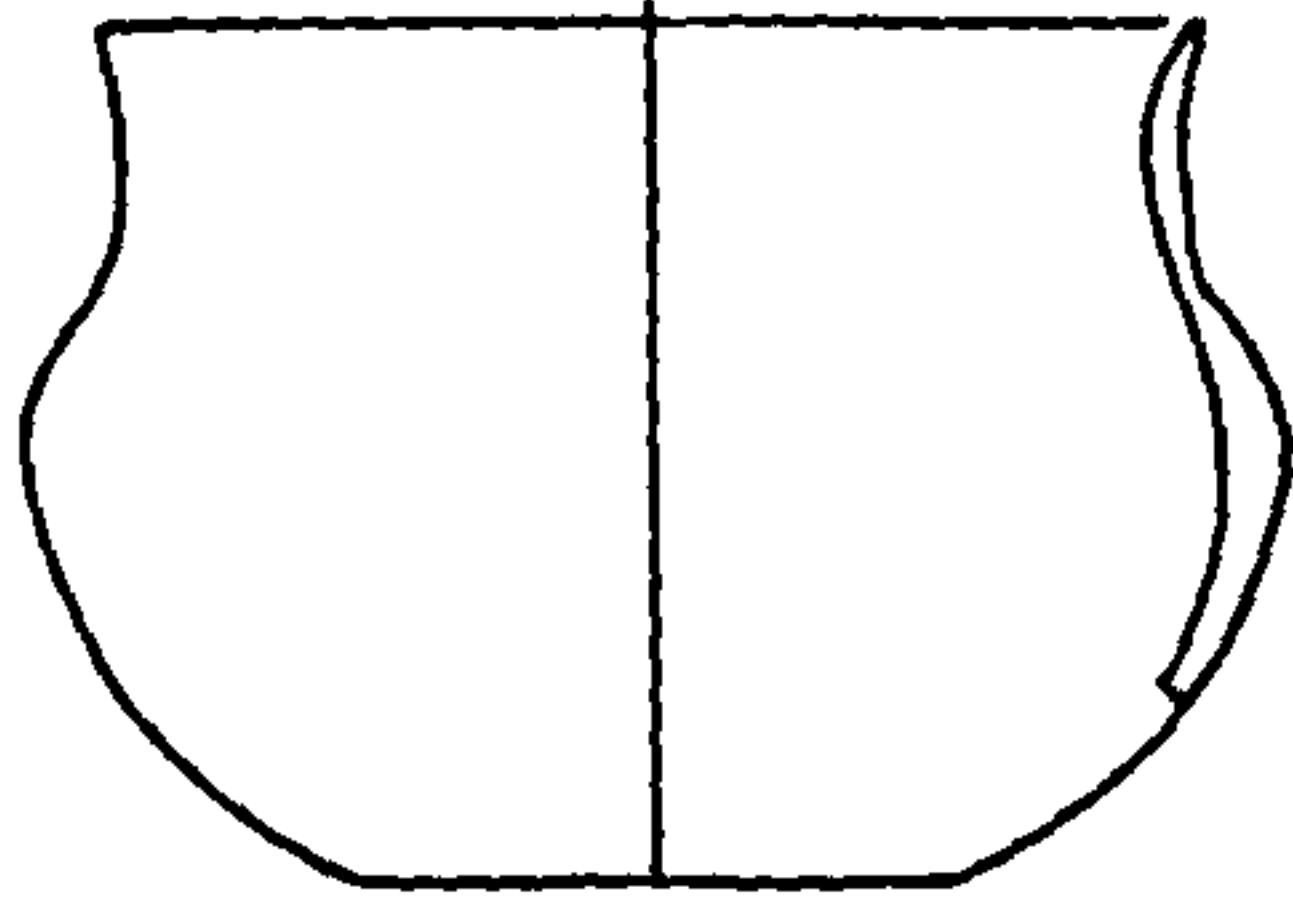

10

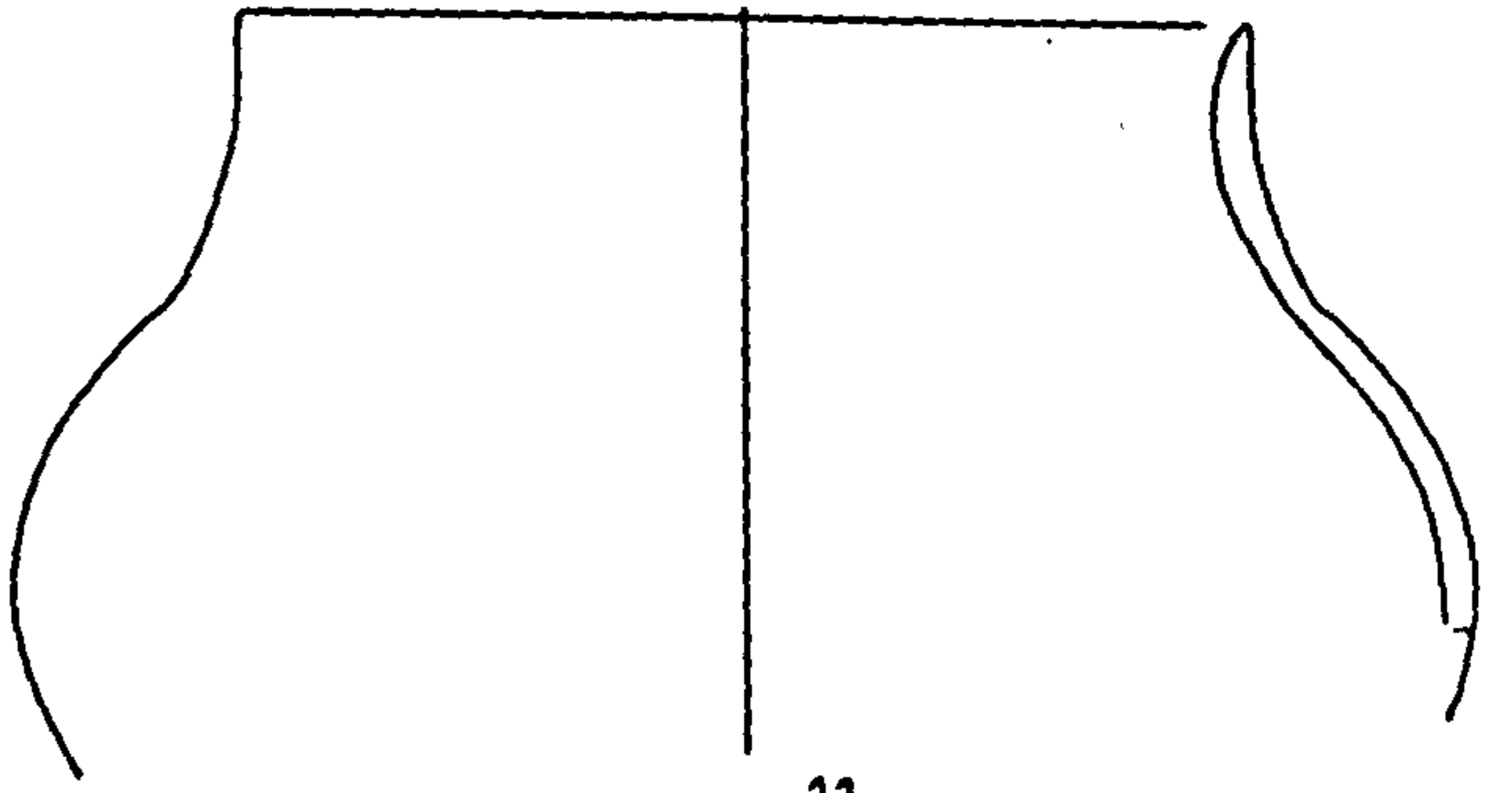

11

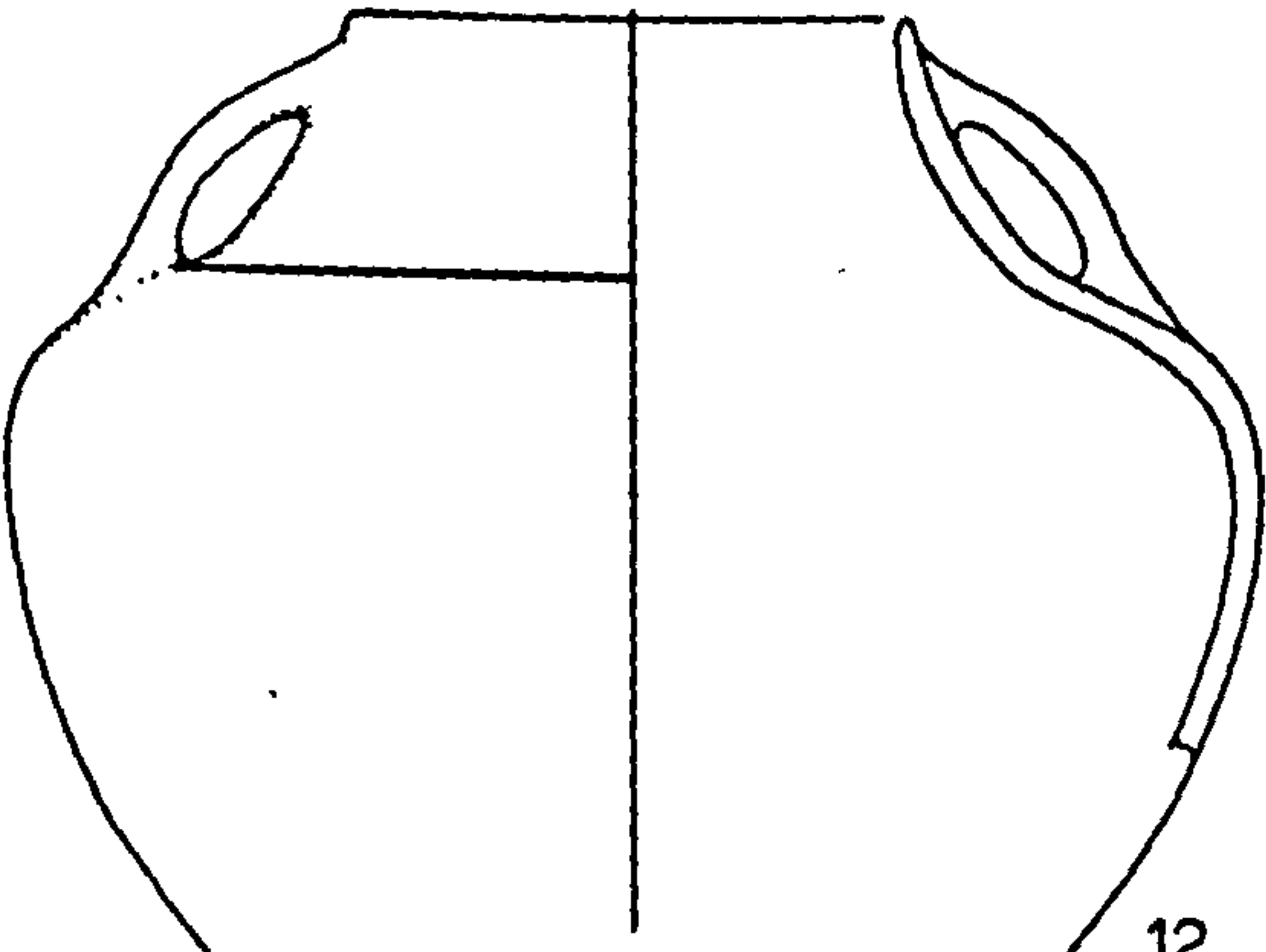

12

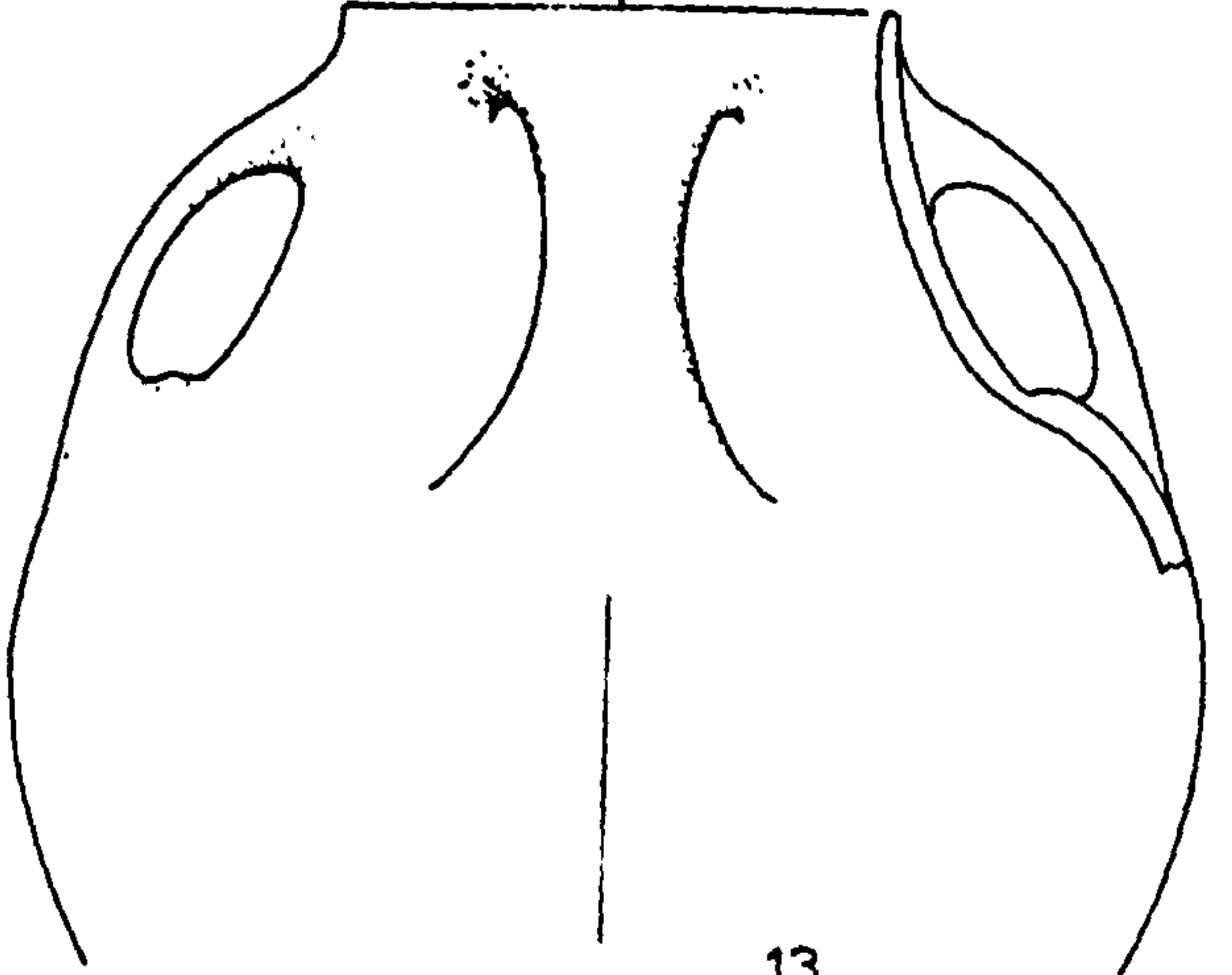

13

Fig 29

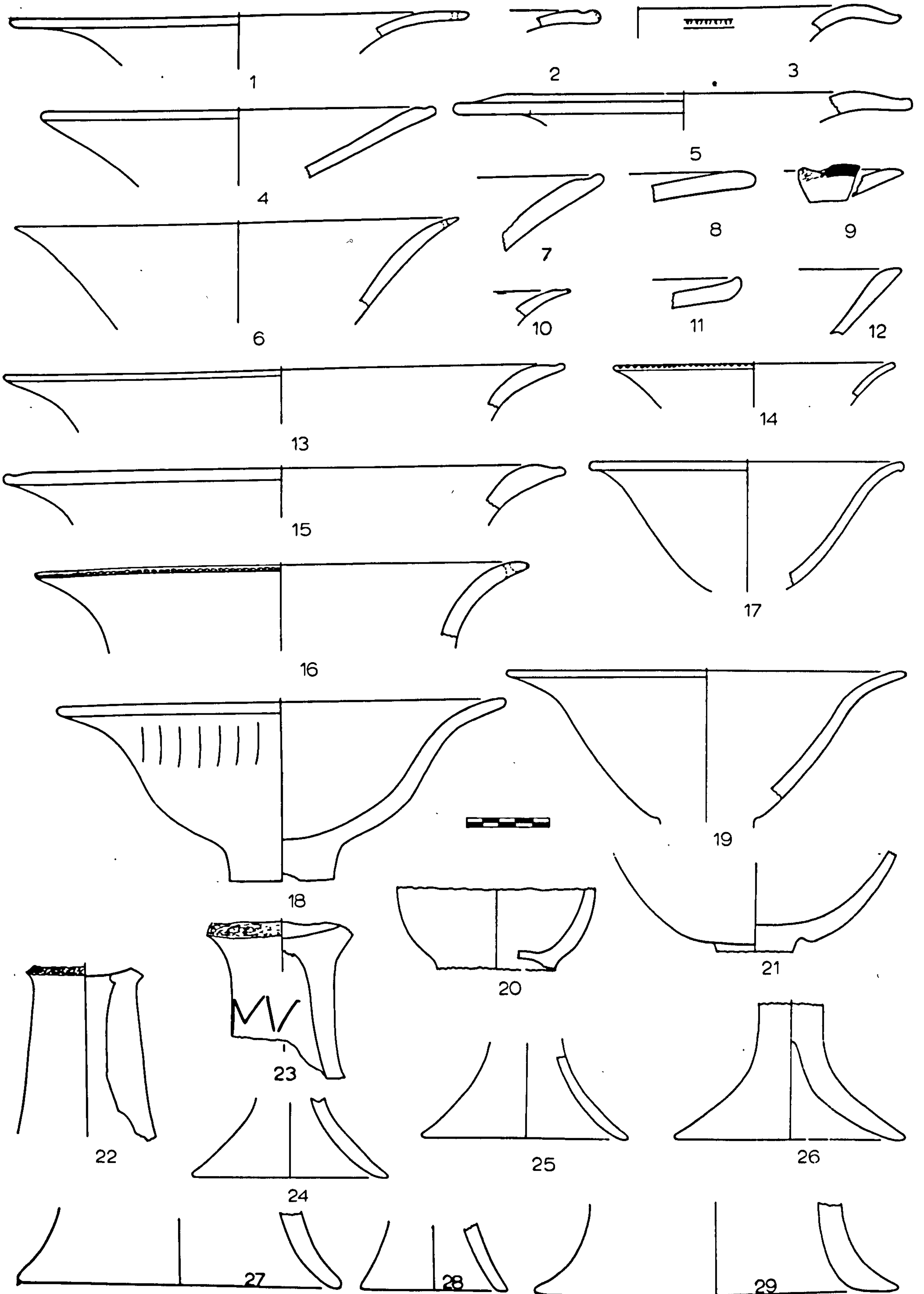

Fig 30

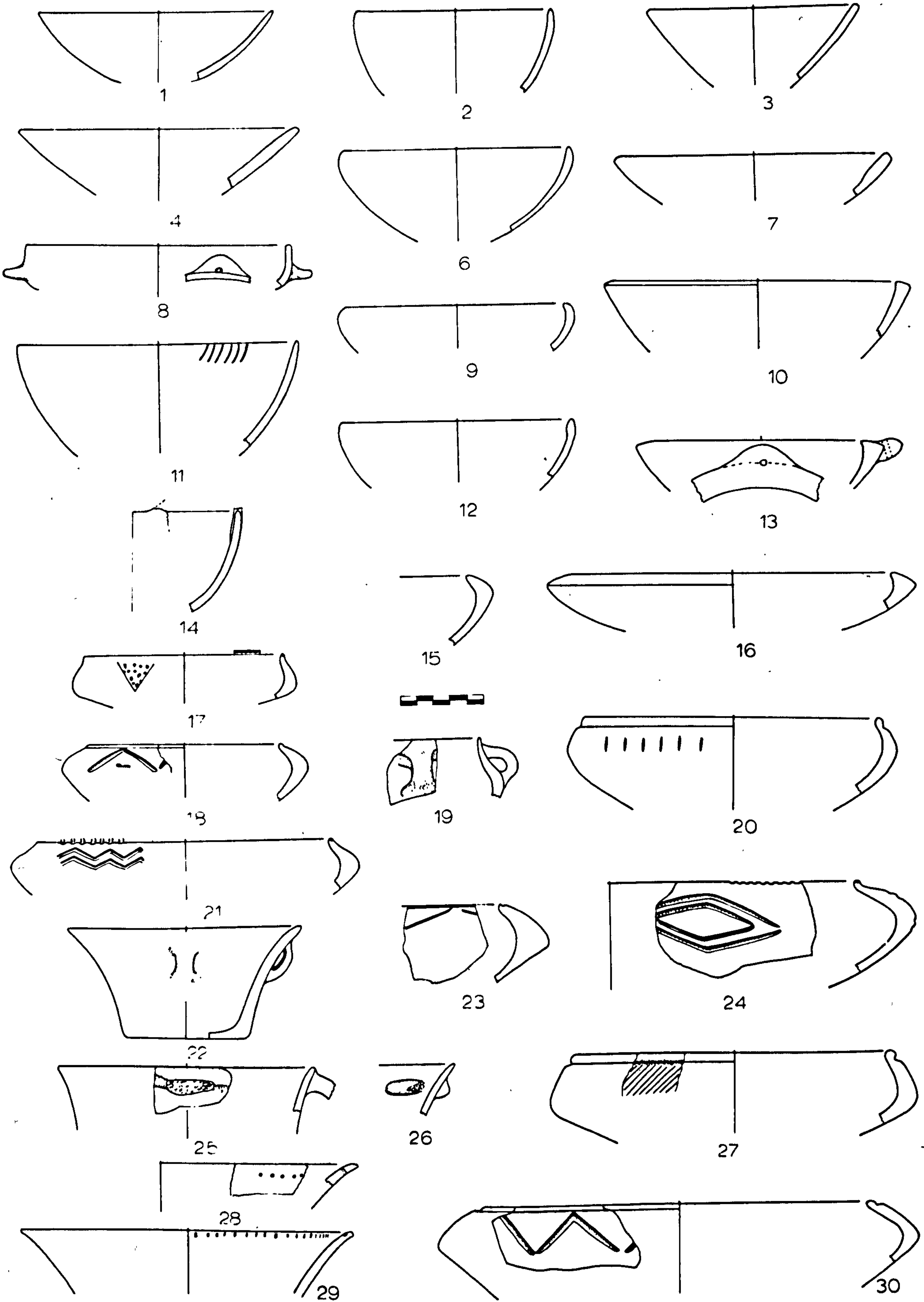

Fig 31



1



2

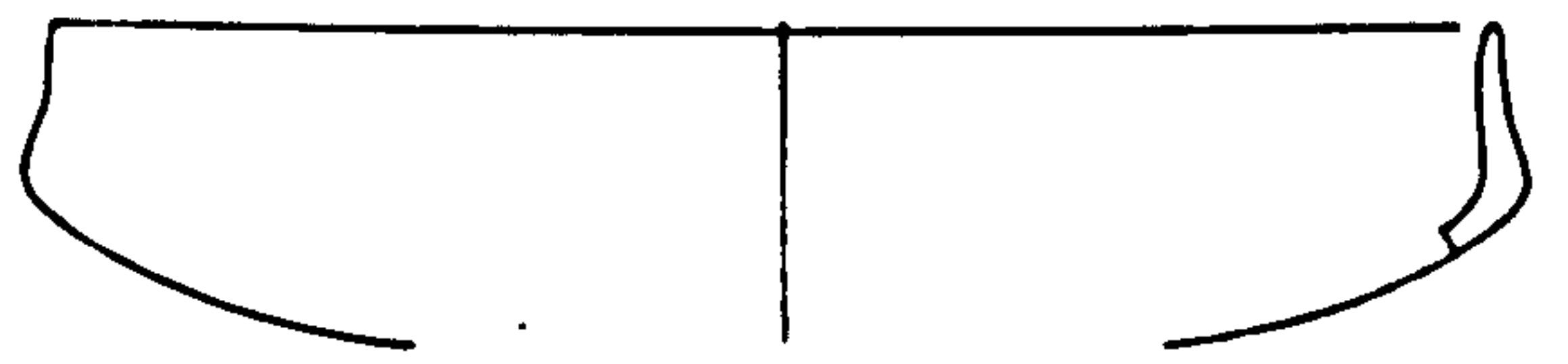

3



4



5

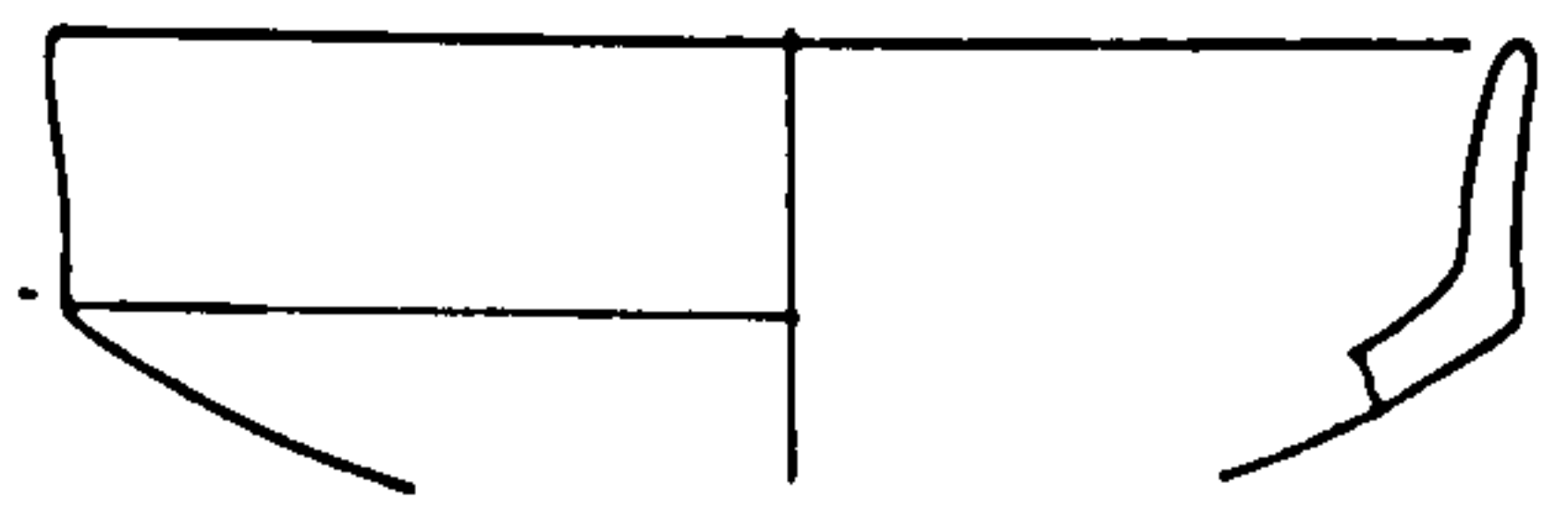

6

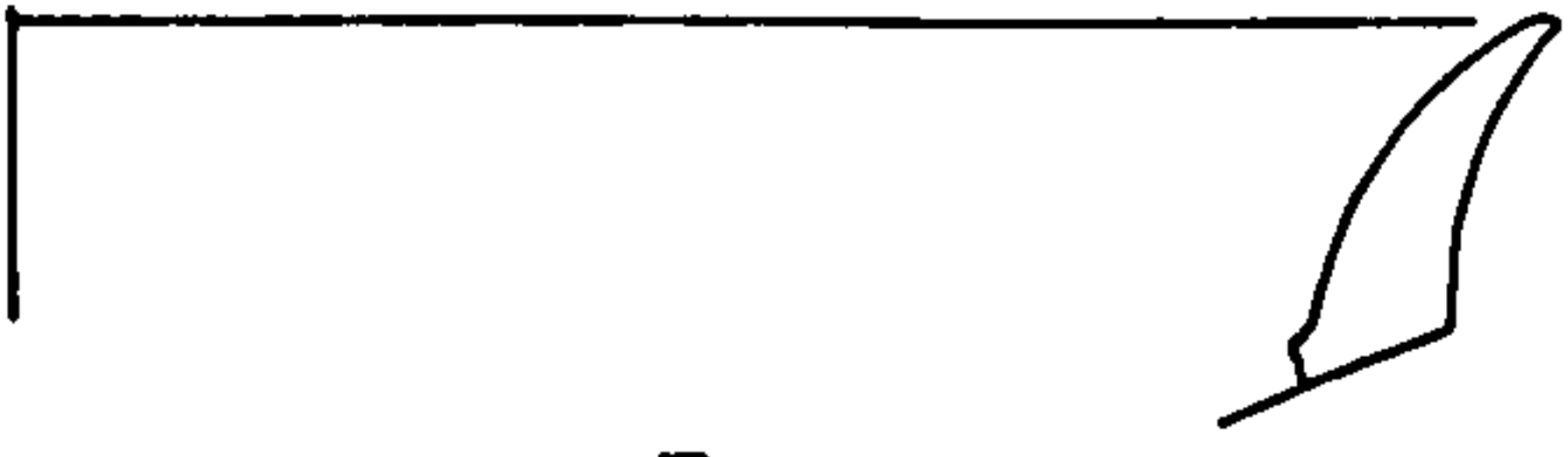

7



8

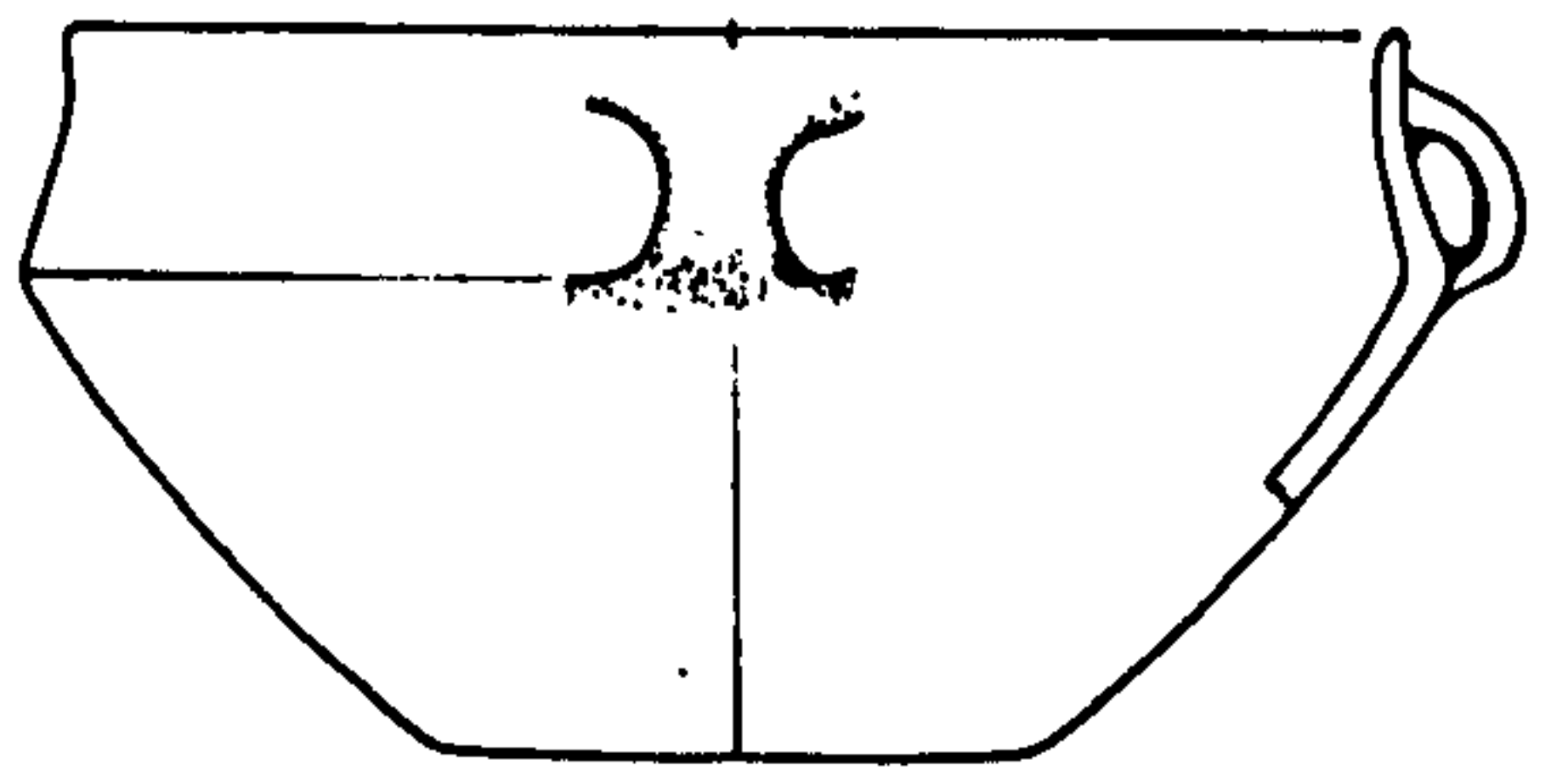

11

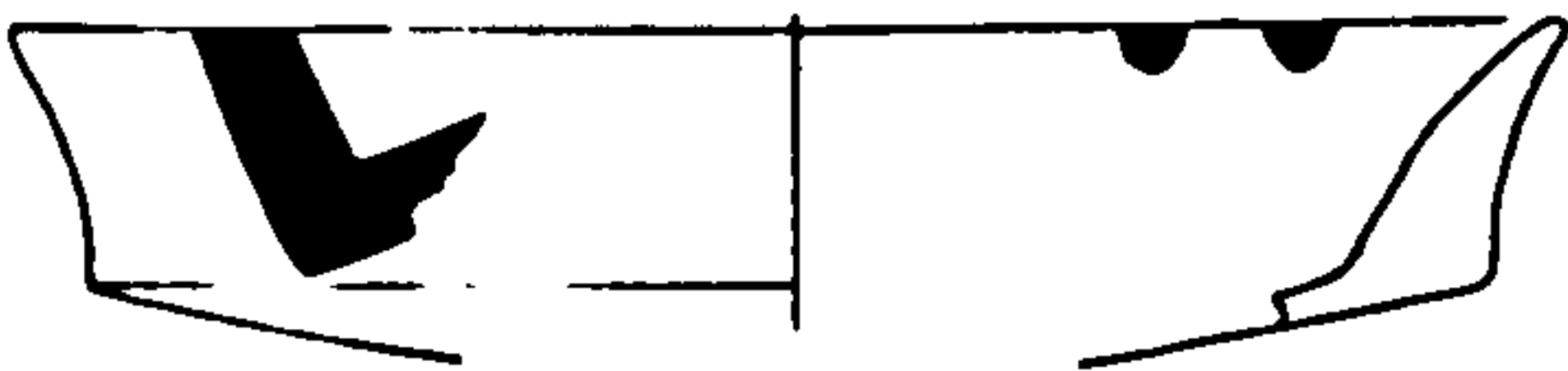

9



10

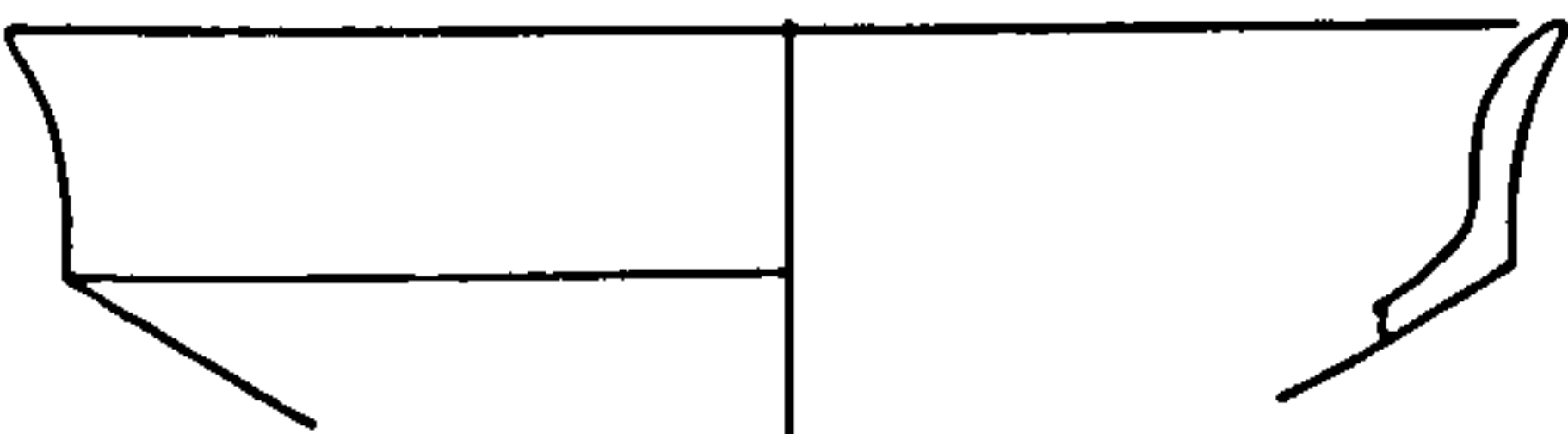

12



13

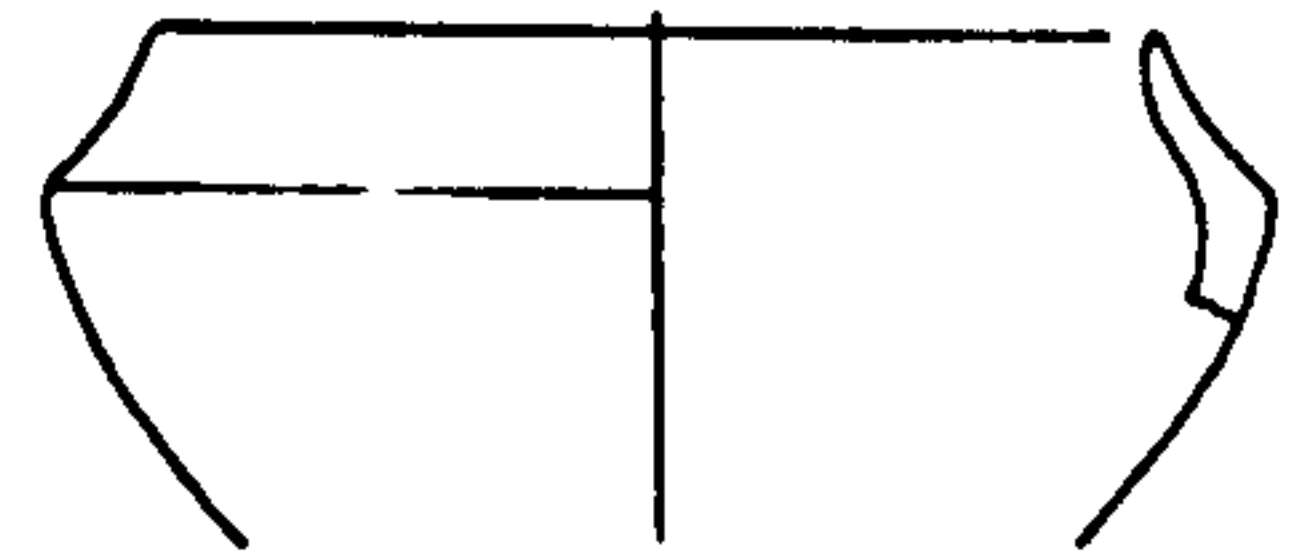

14

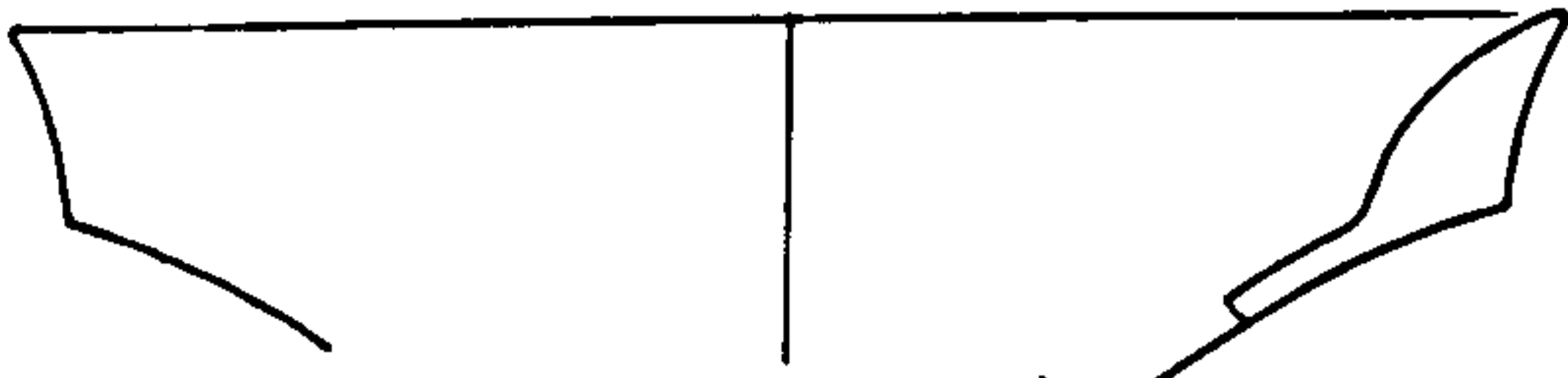

15



16

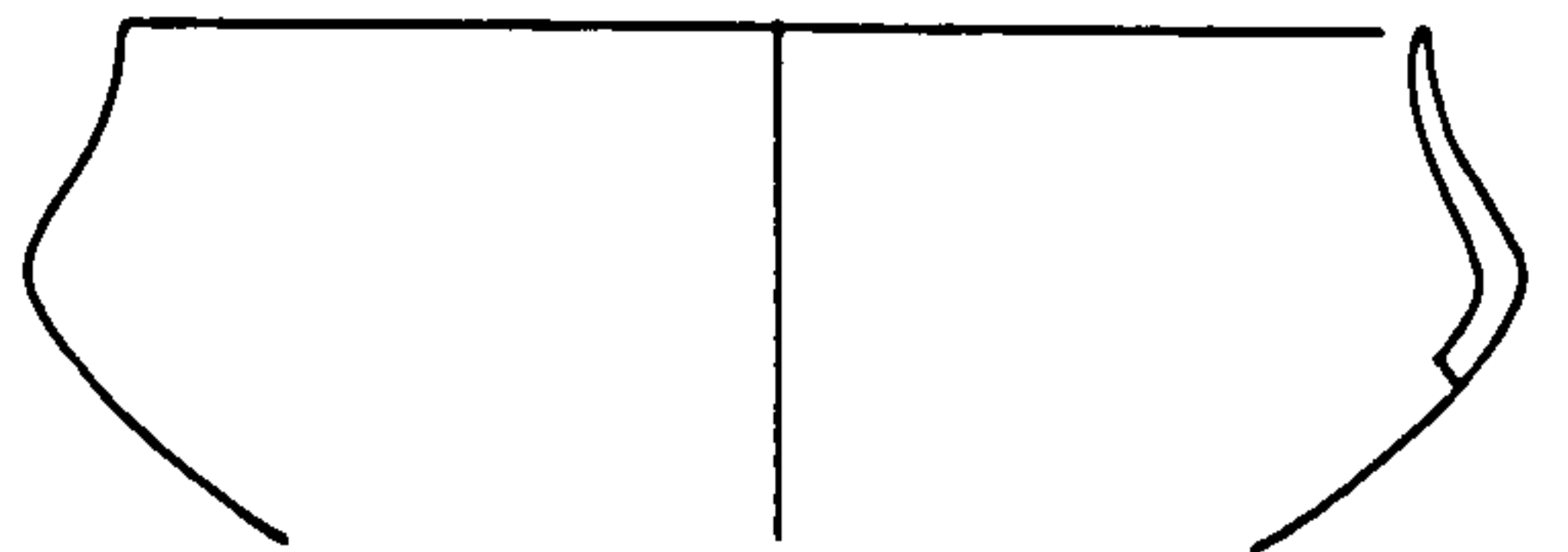

17

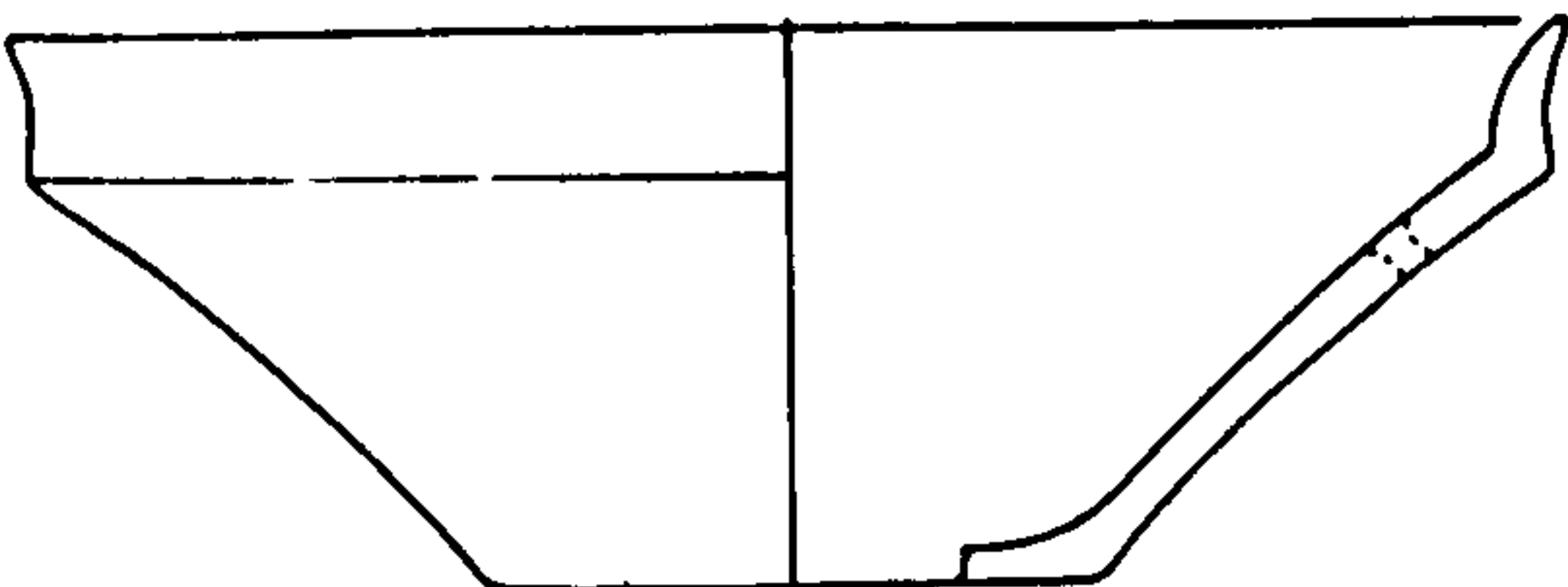

18



19

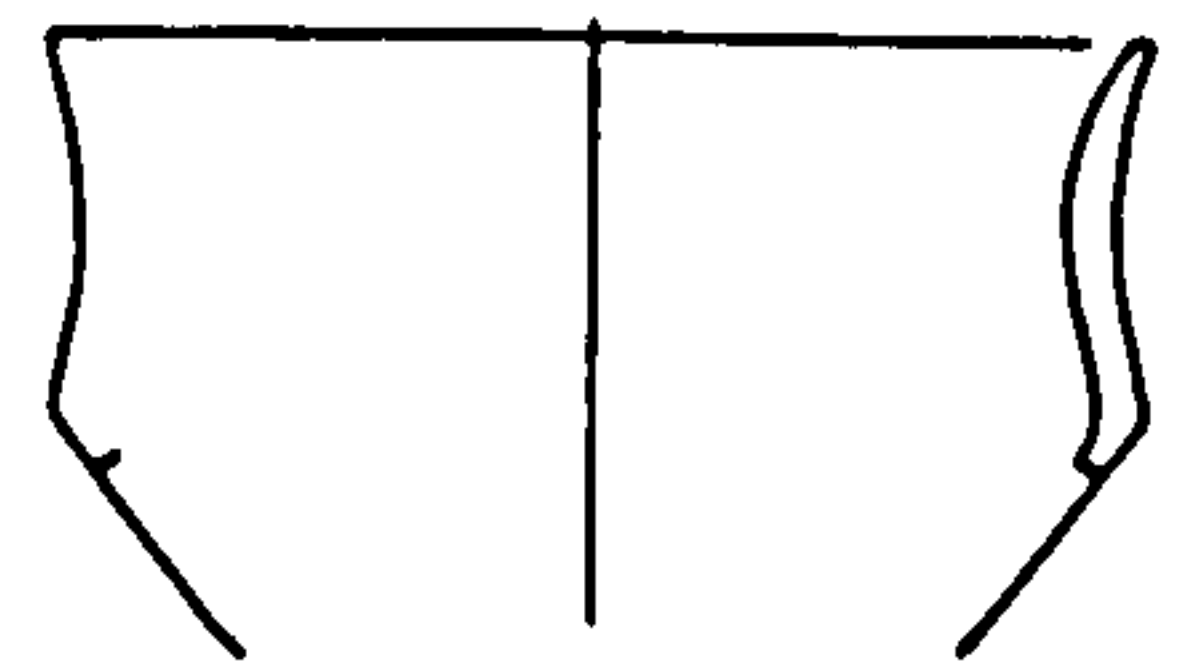

20

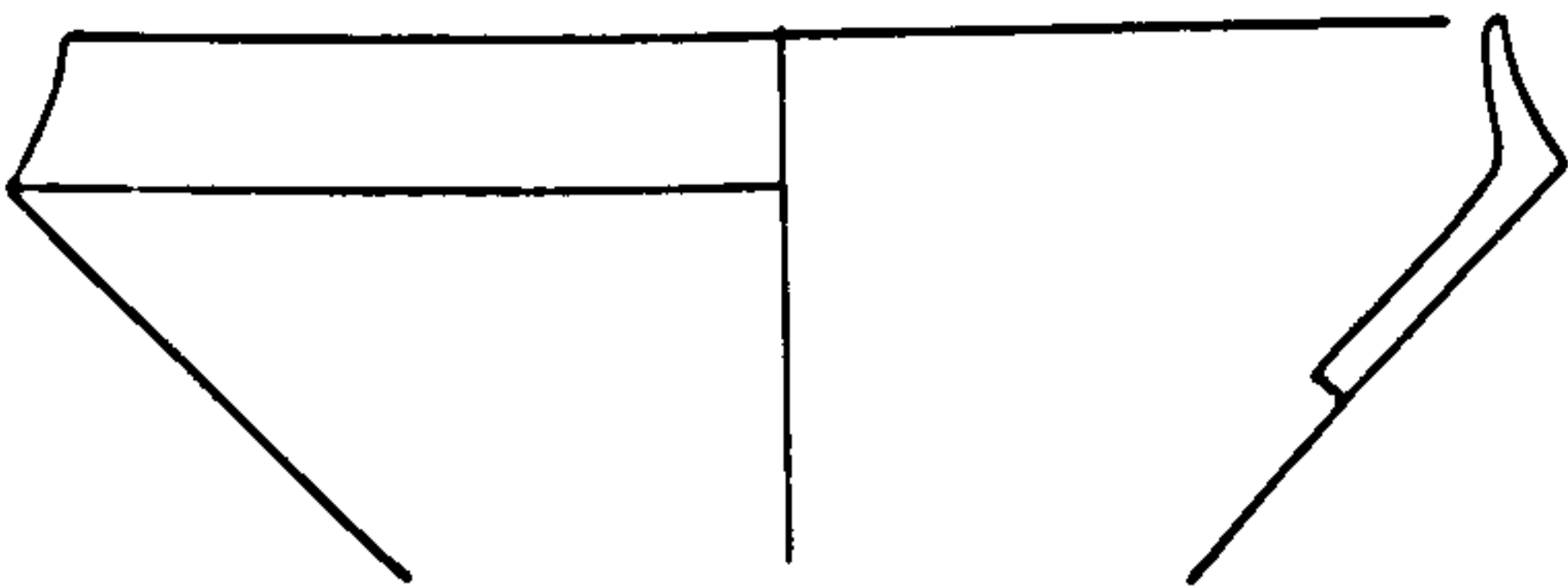

22



21

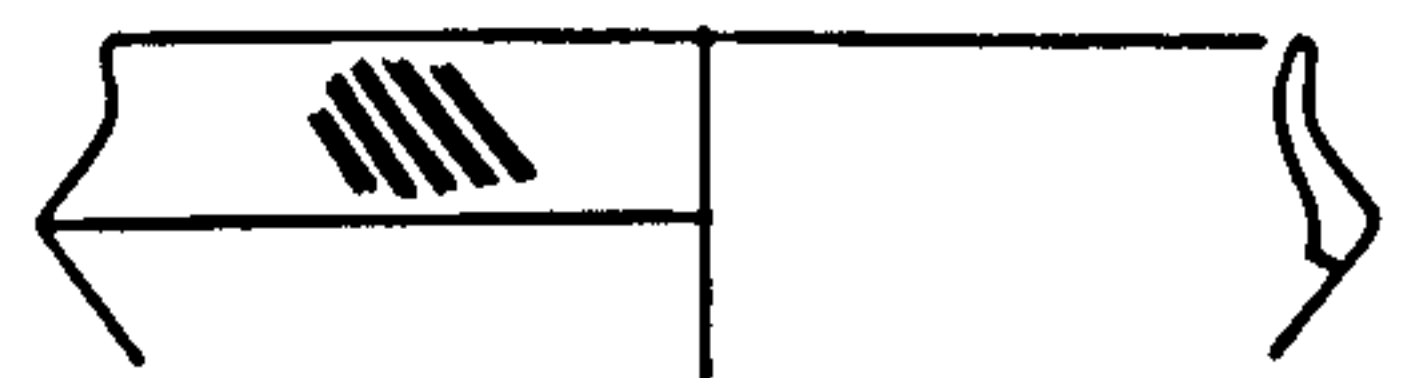

24

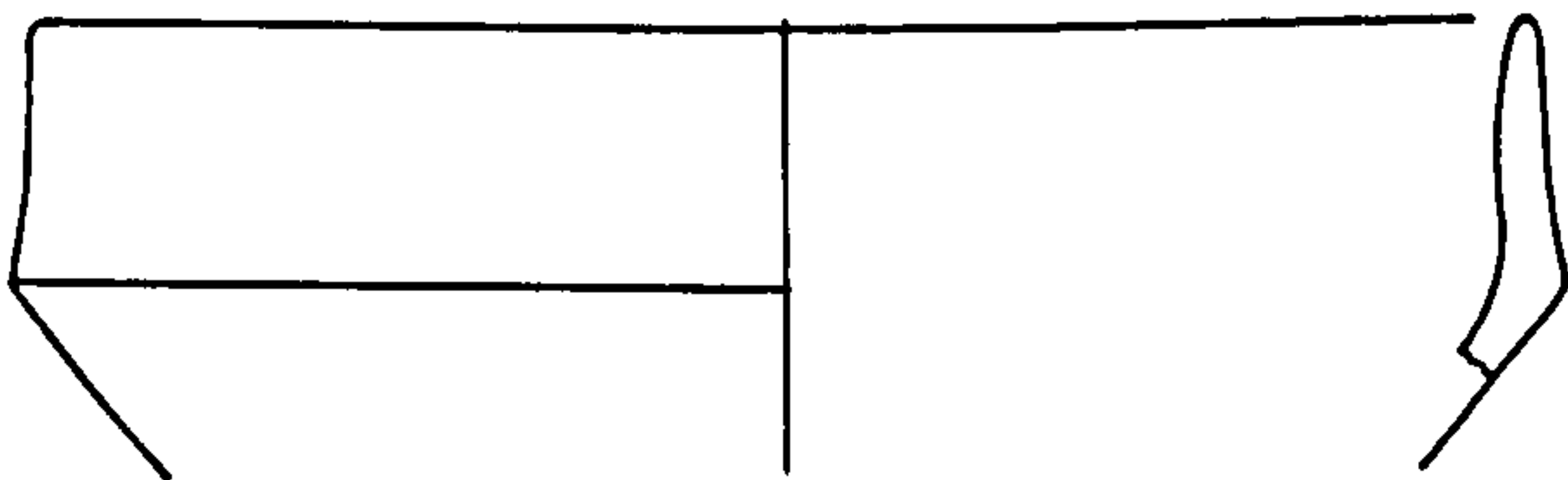

25

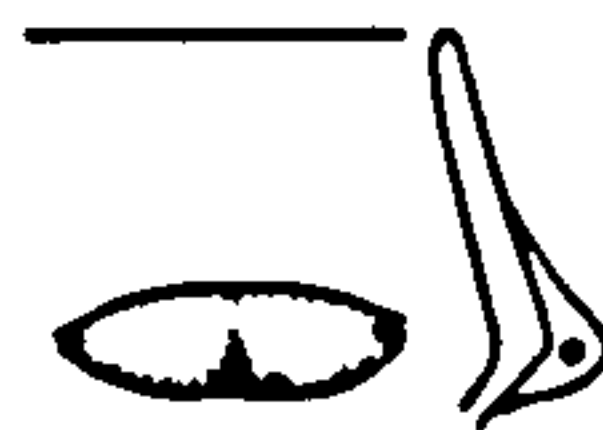

23

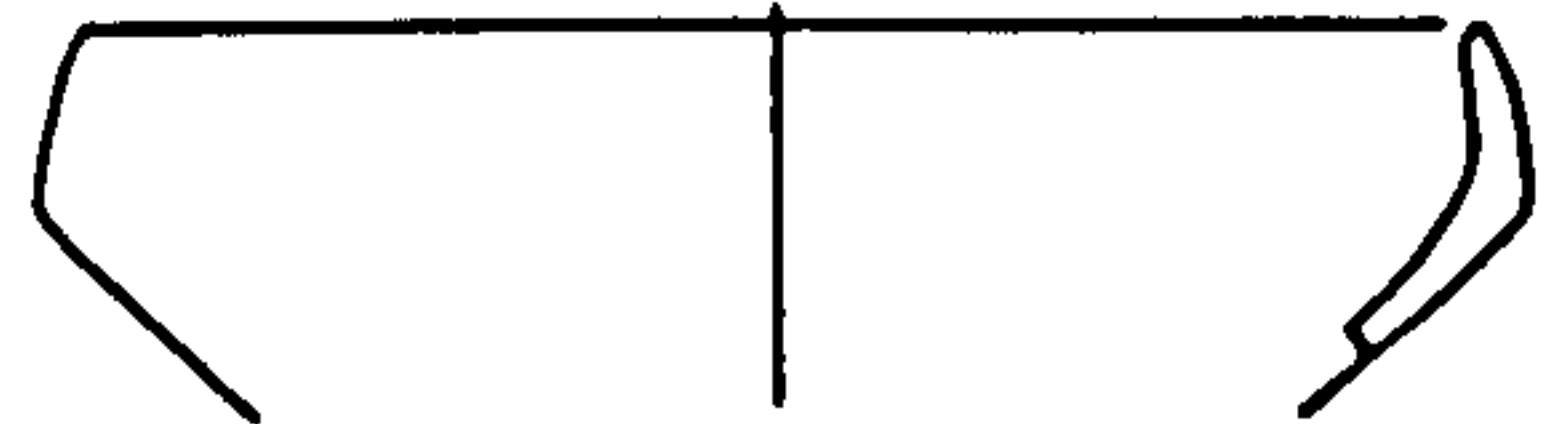

27

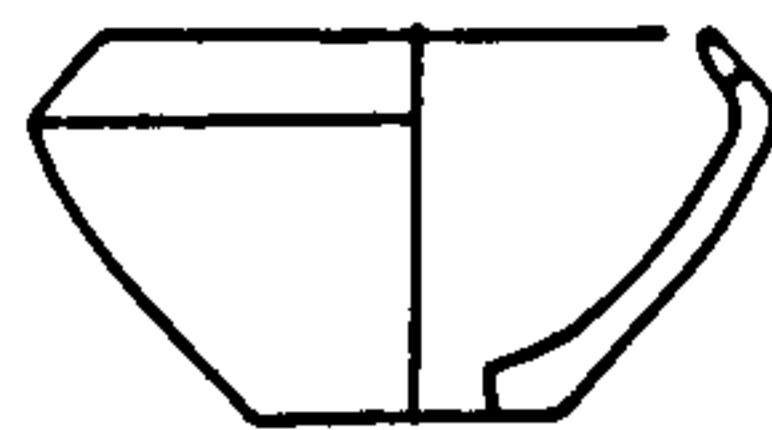

26

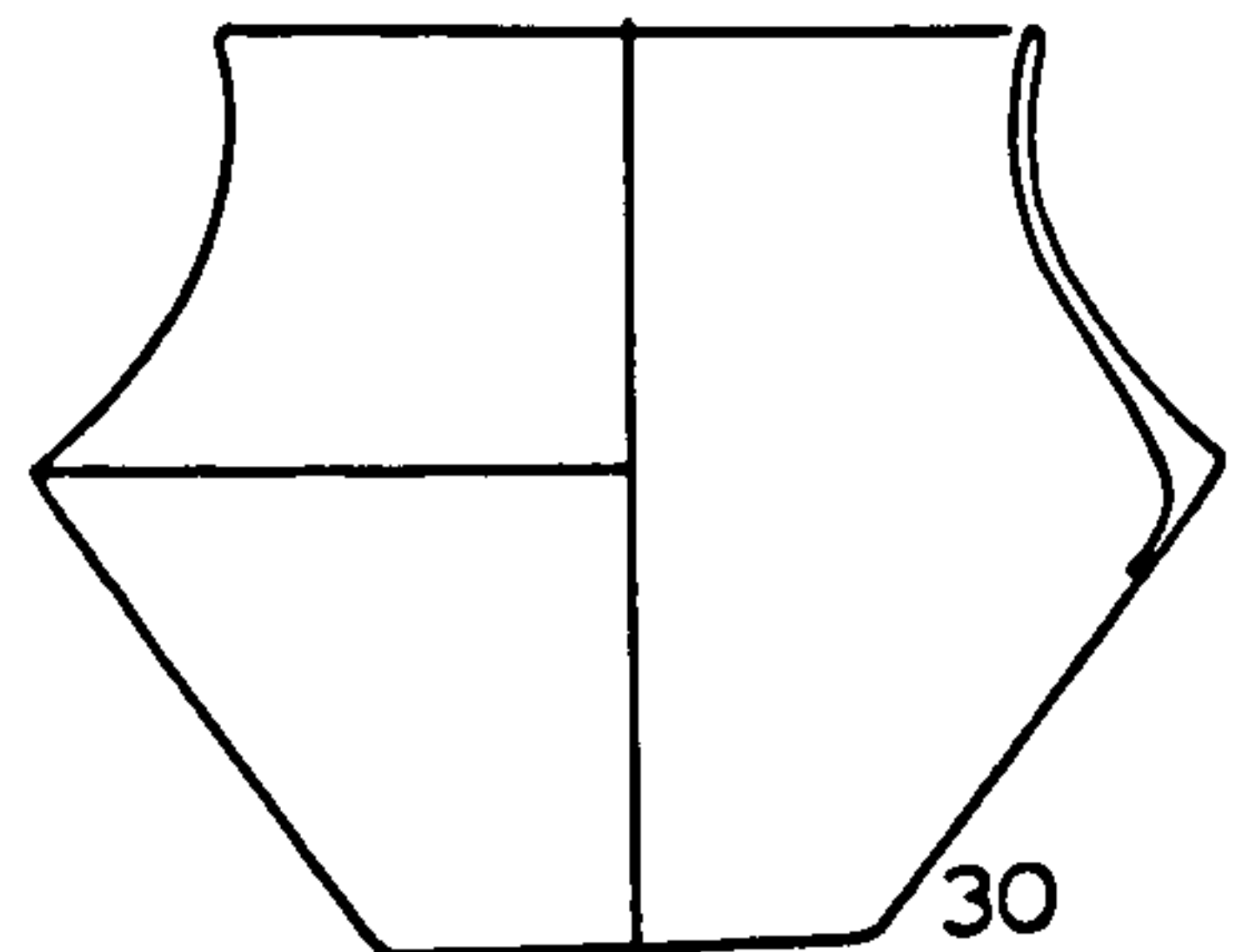

30

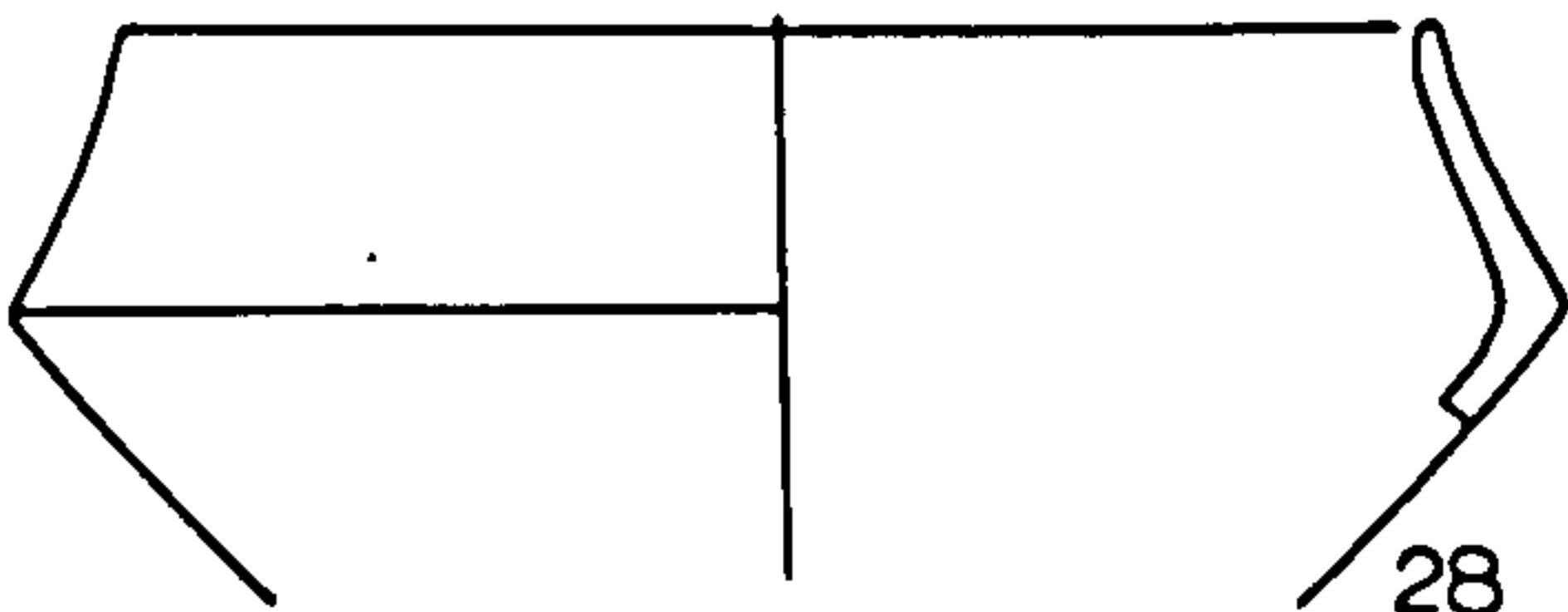

28



29

Fig.32

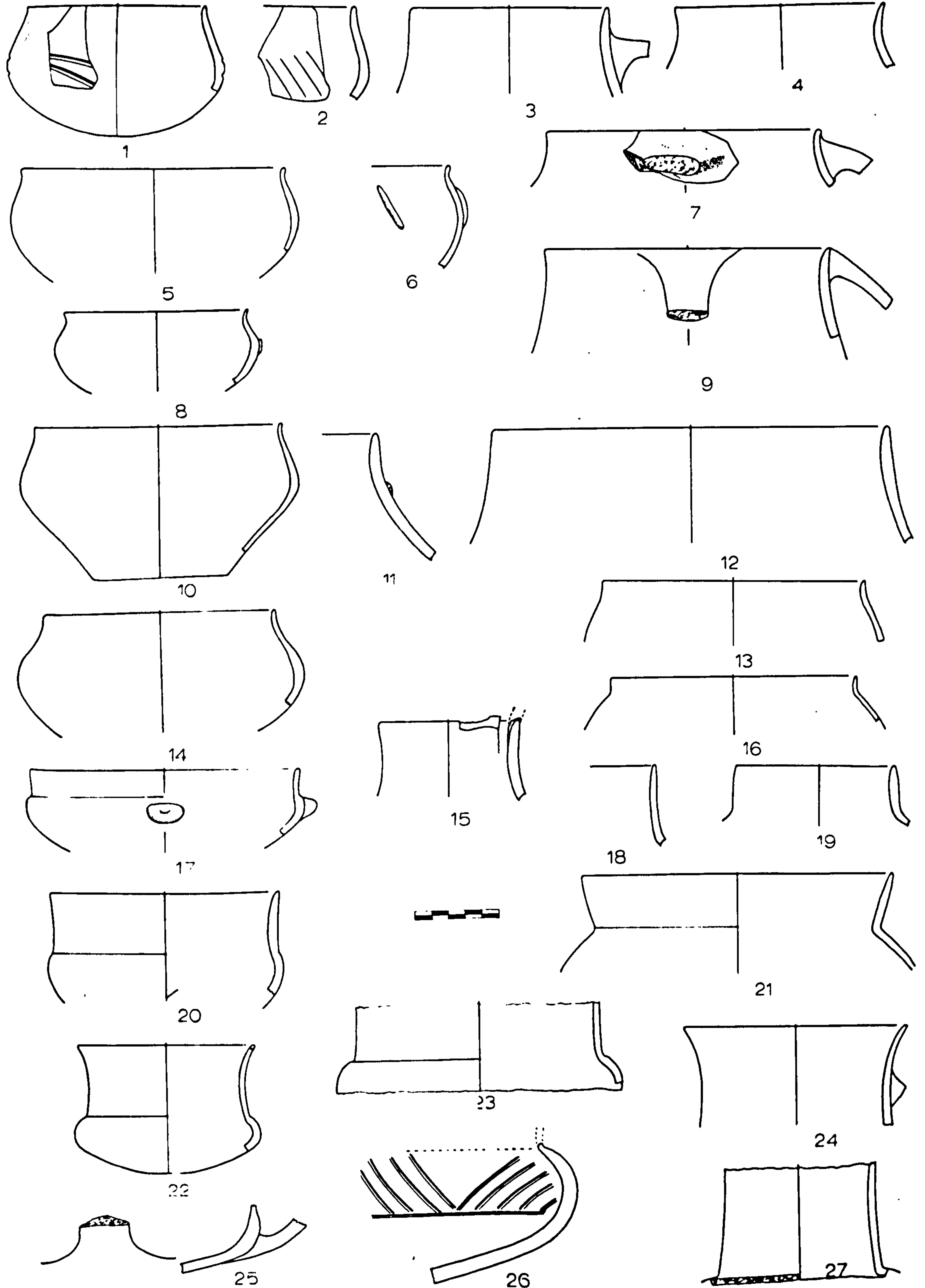

Fig 33

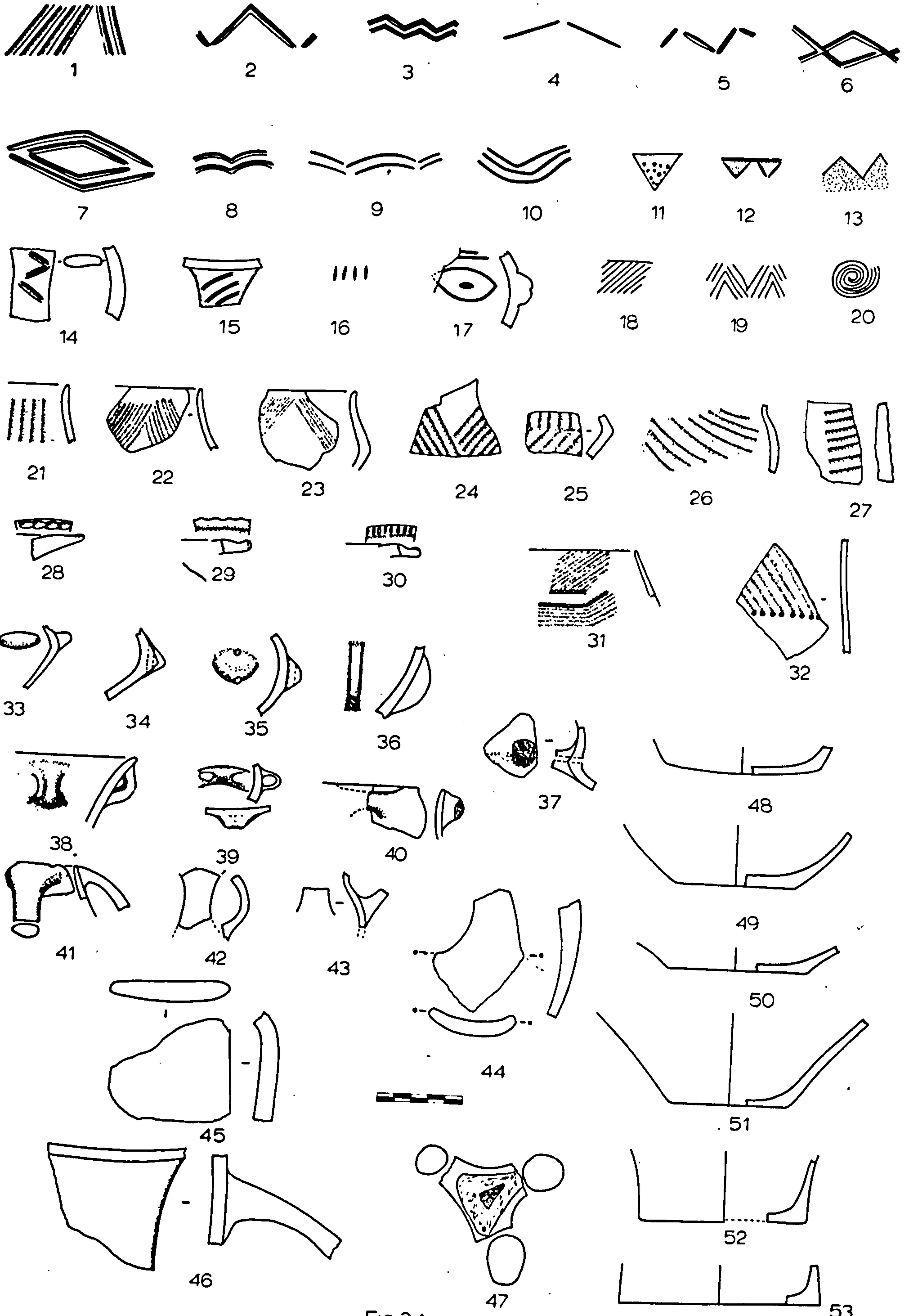

Fig 34

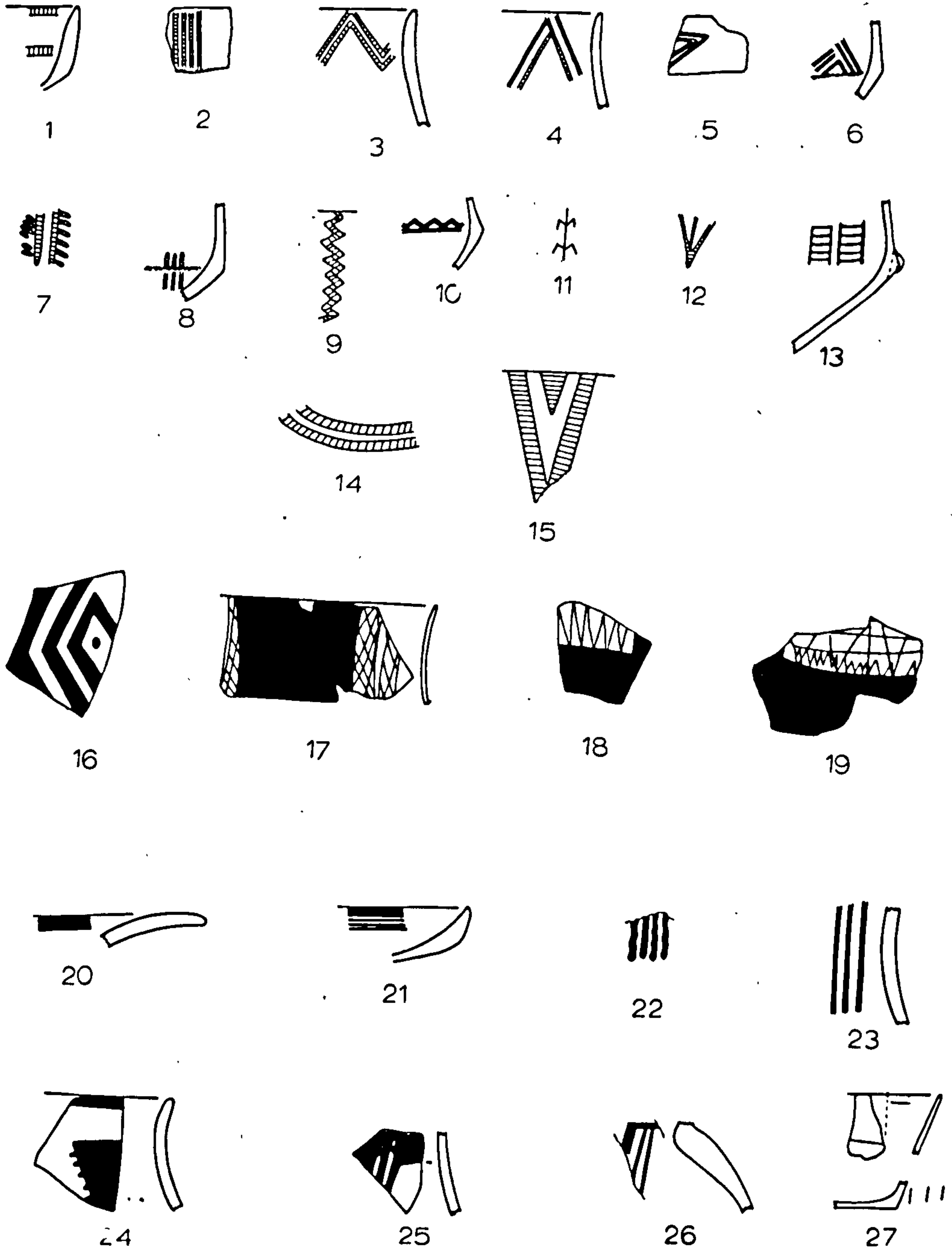

Fig 35

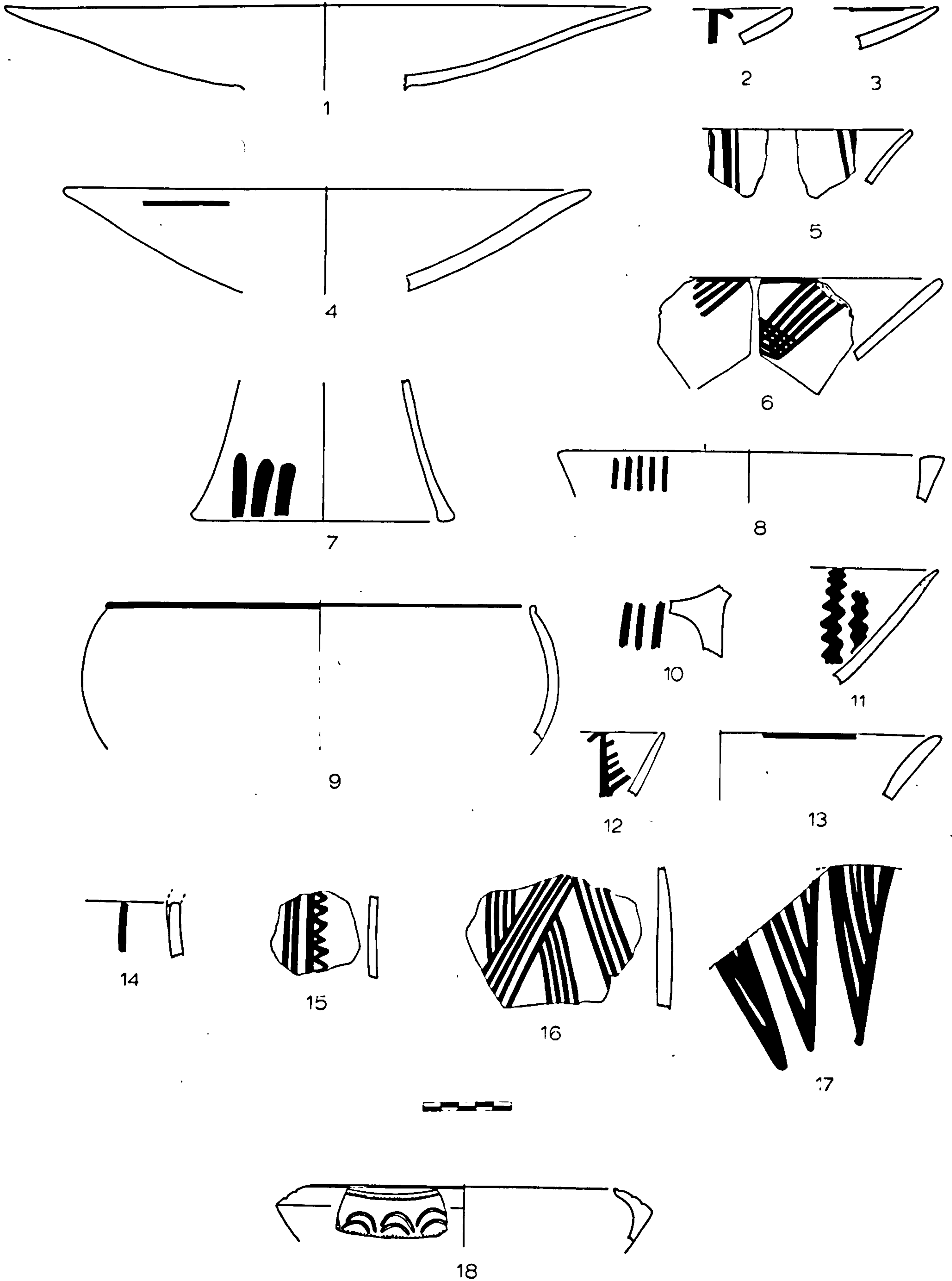

Fig 36

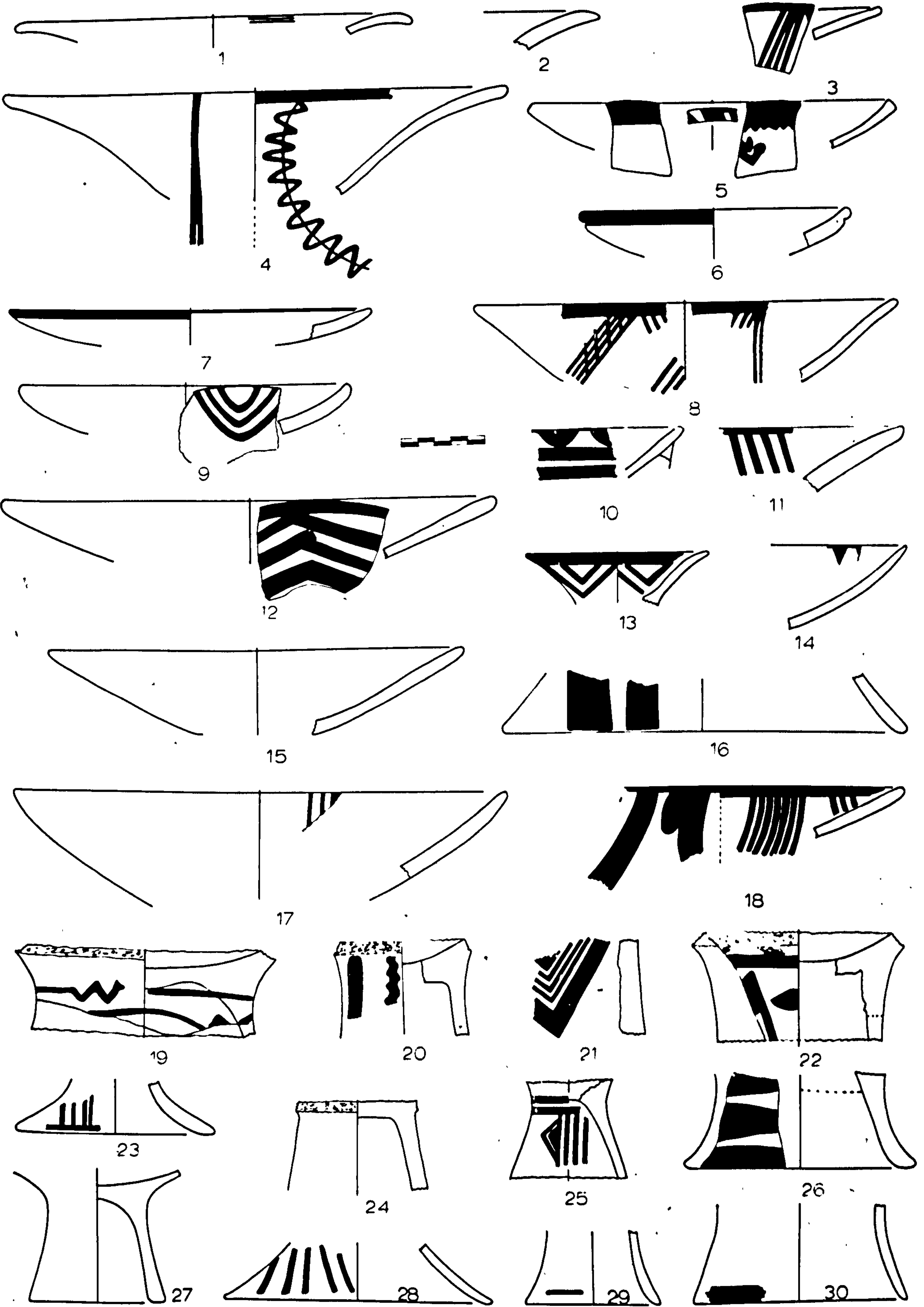

Fig 37

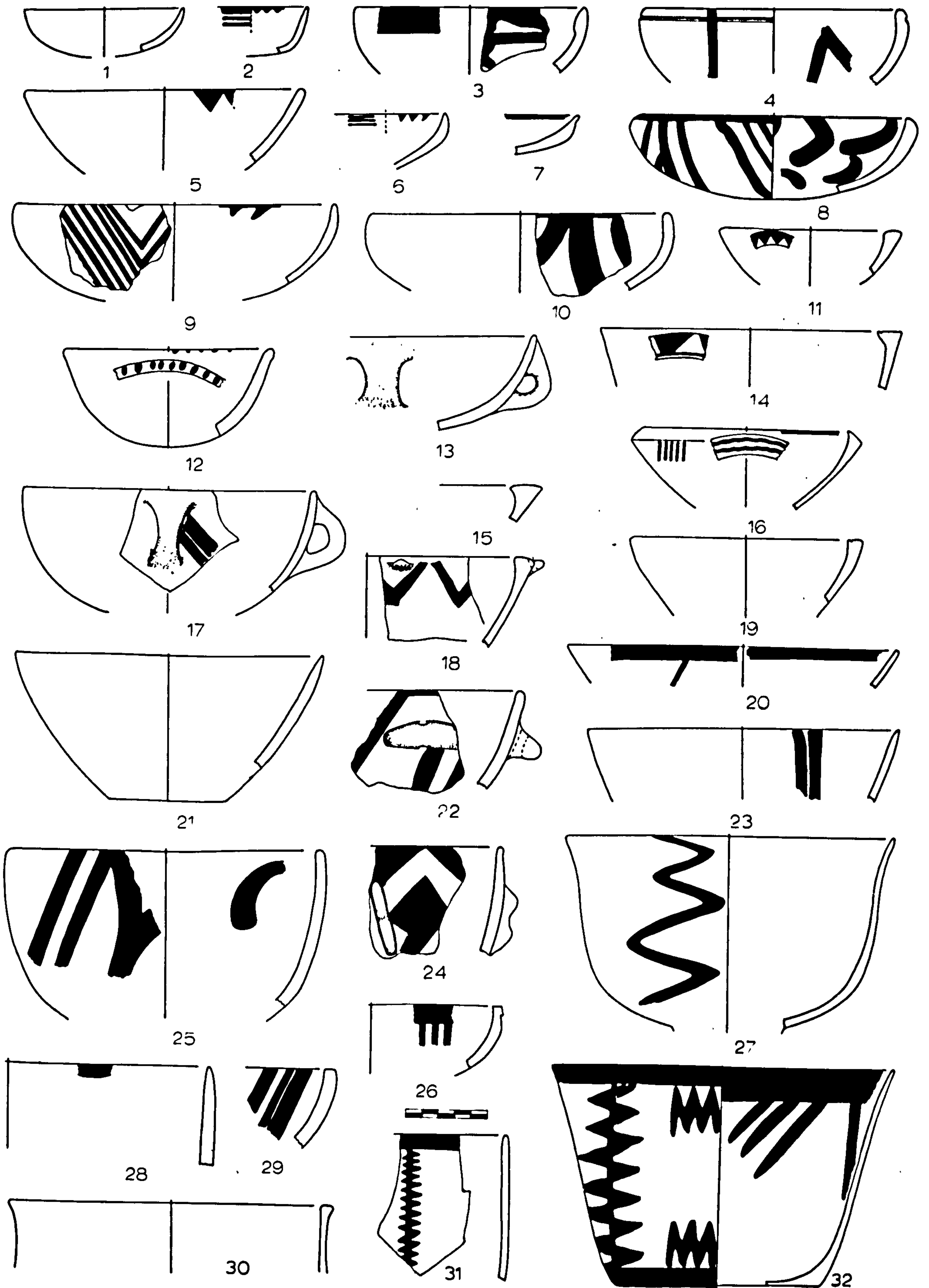

Fig 38

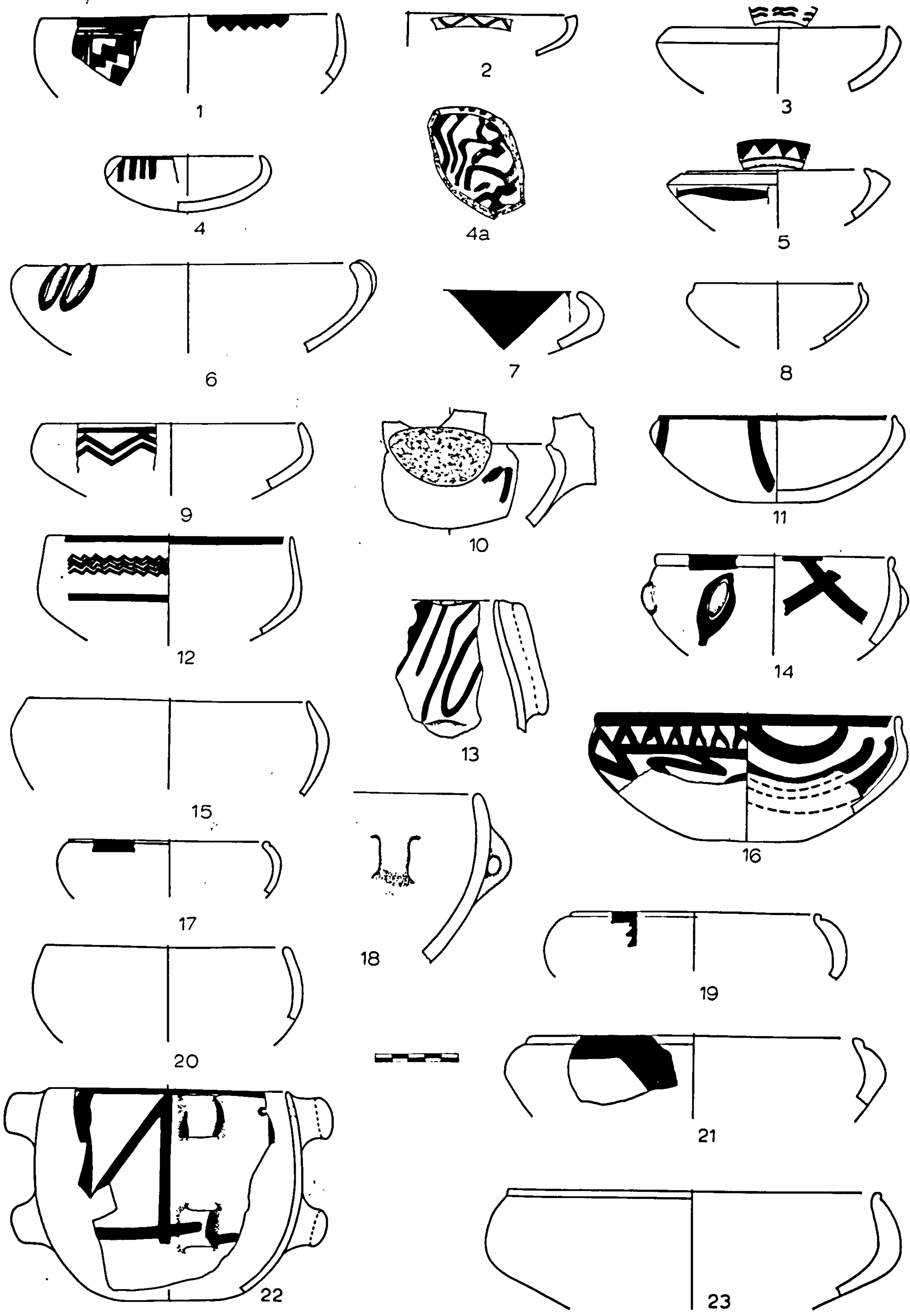

Fig.39

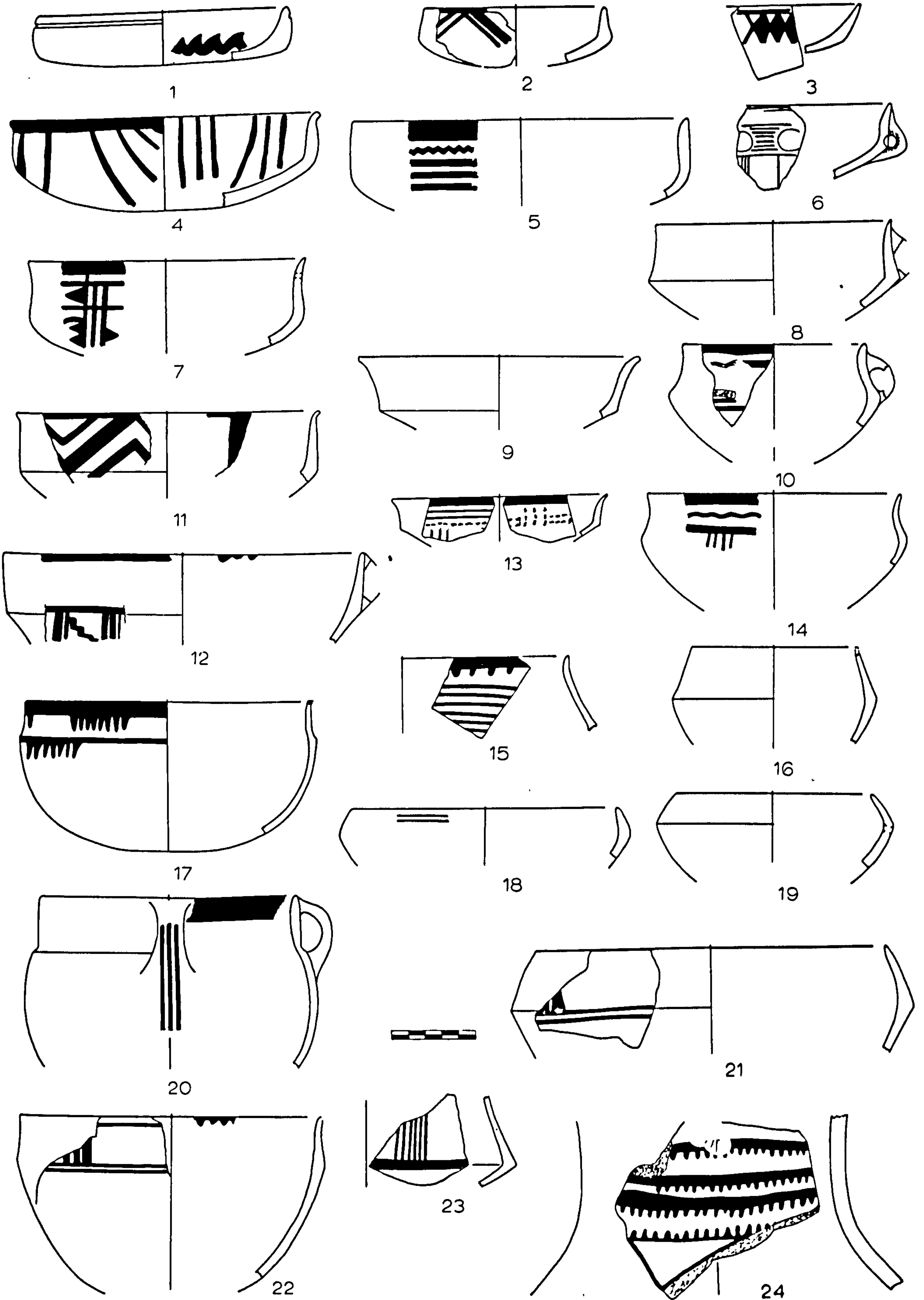

Fig 40

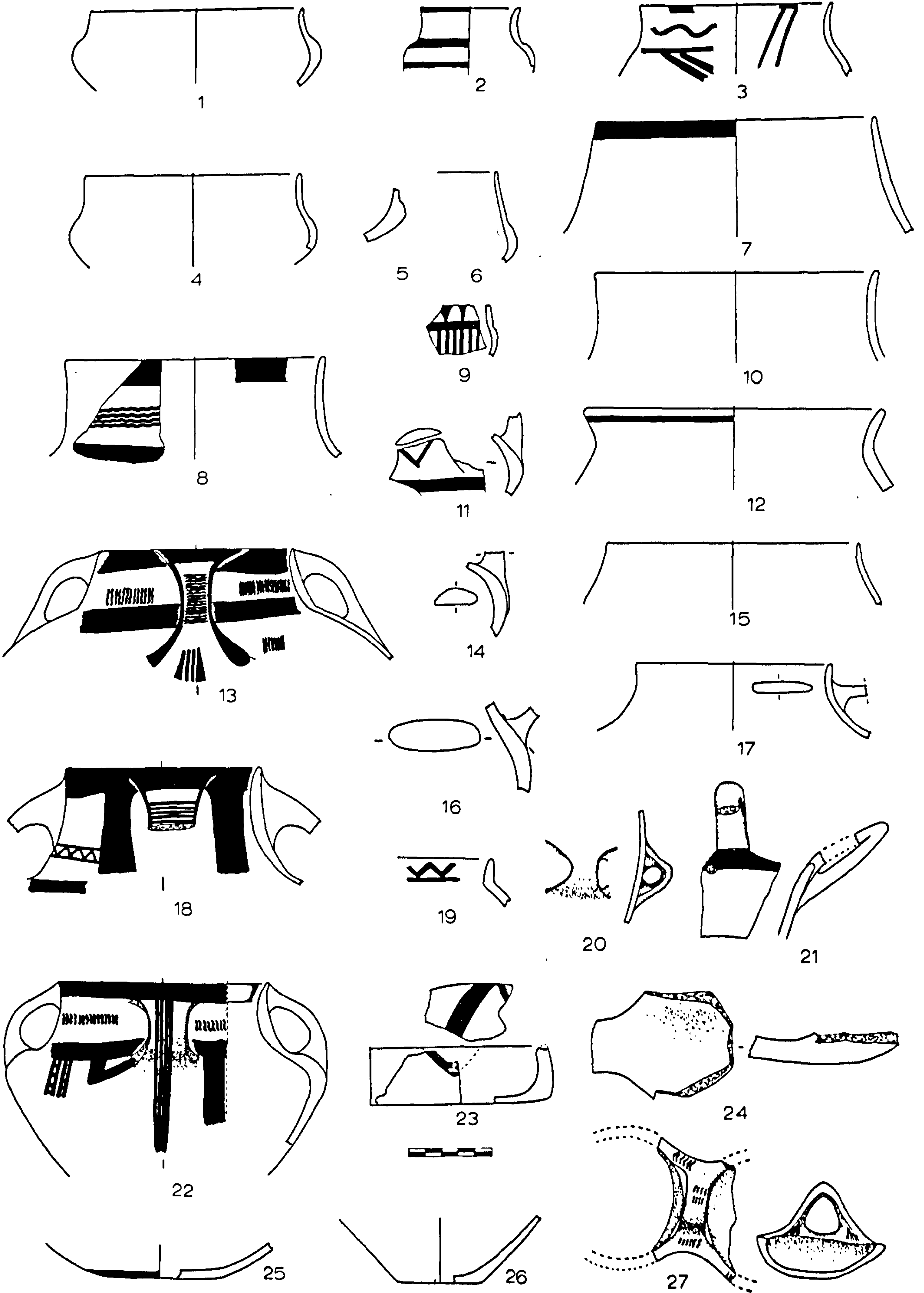

Fig 41

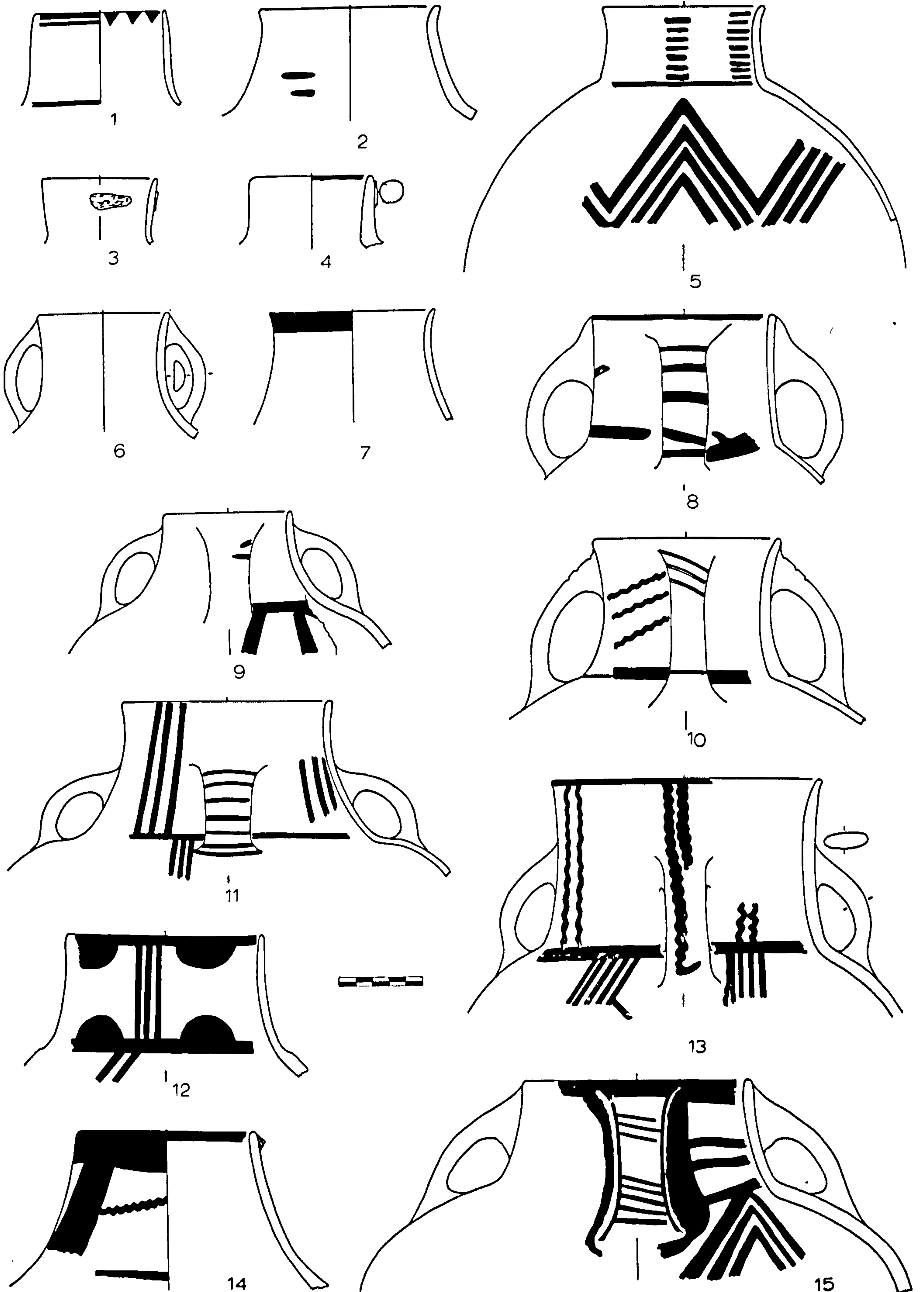

Fig 42

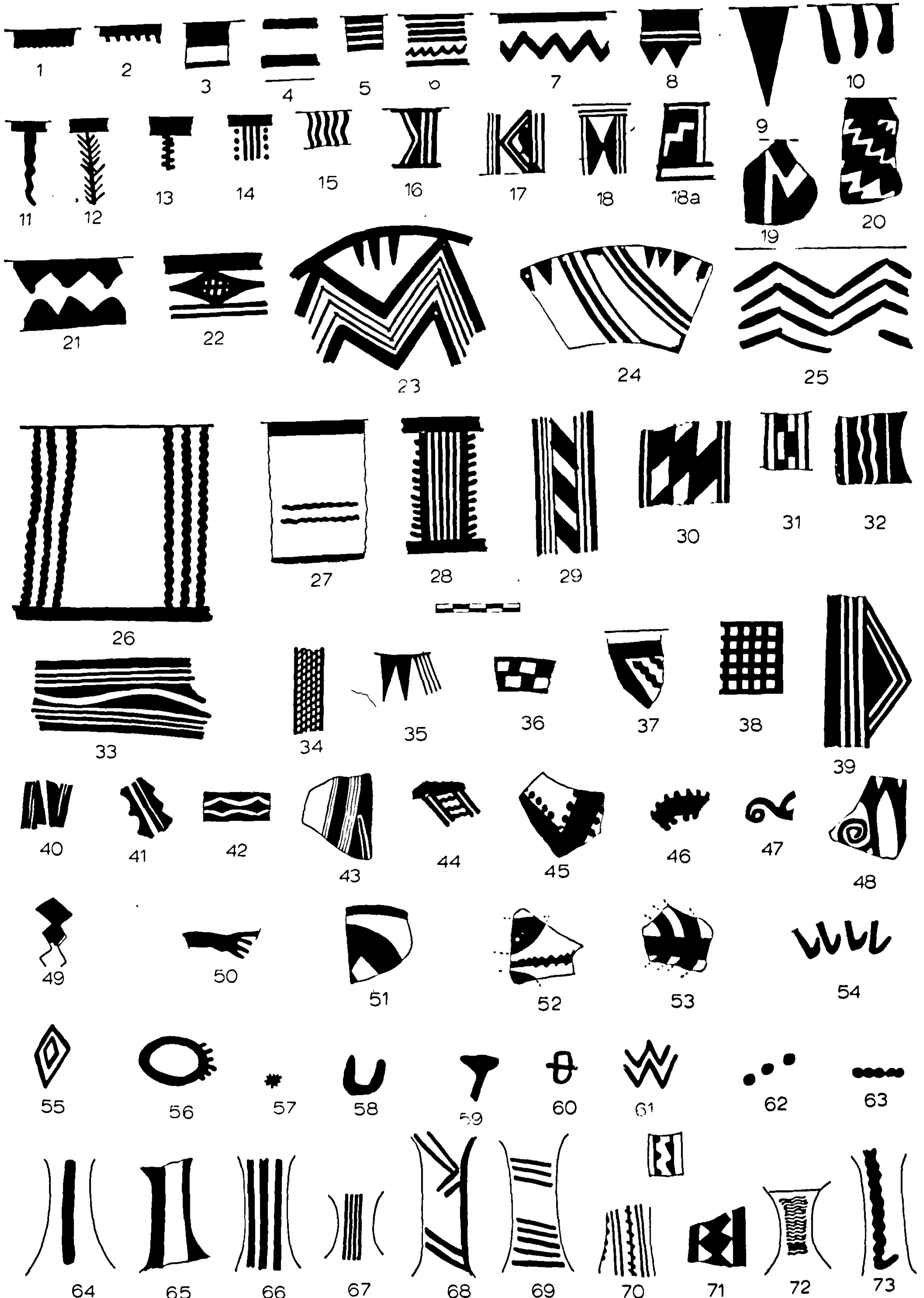

Fig 43

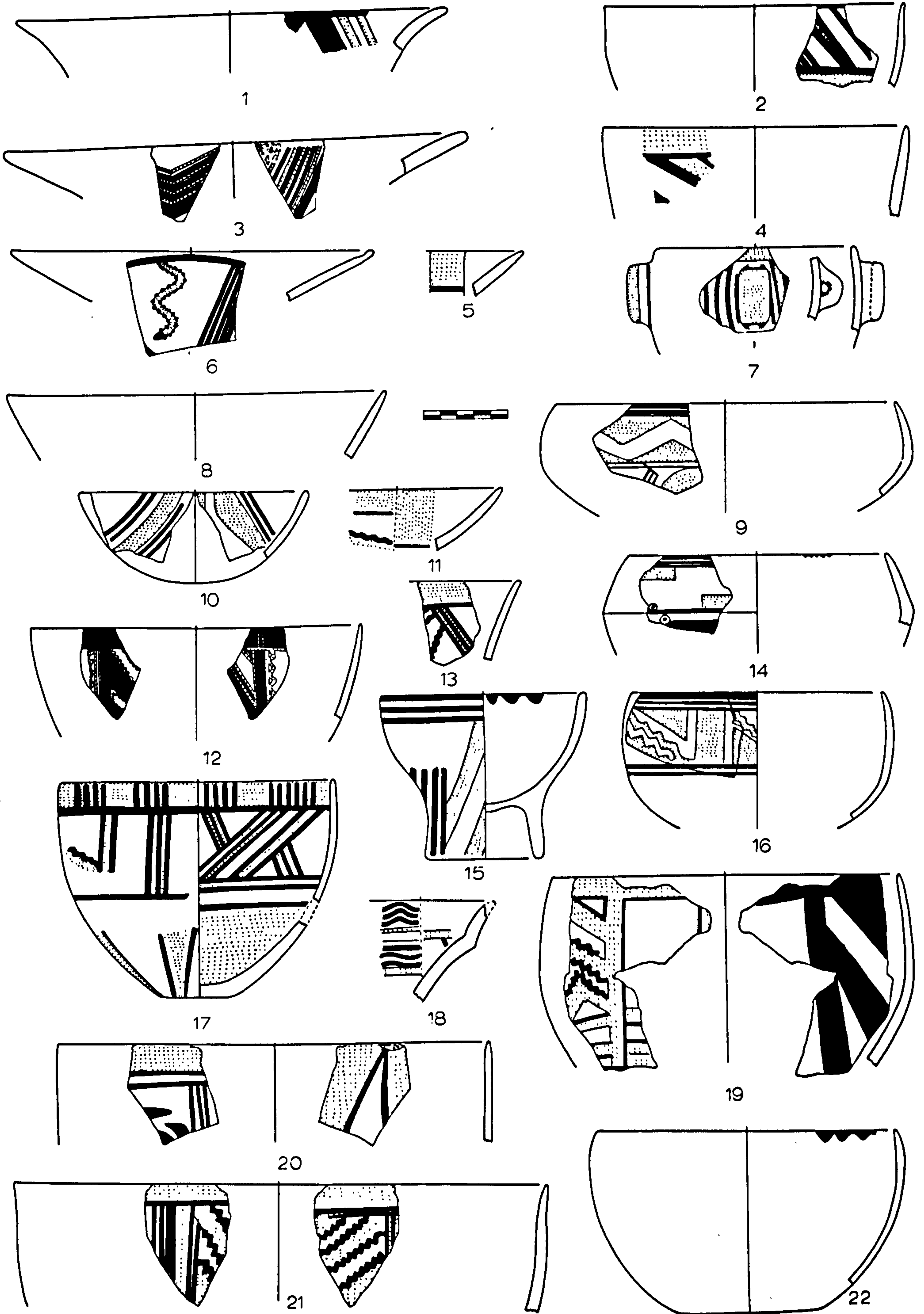

Fig.44

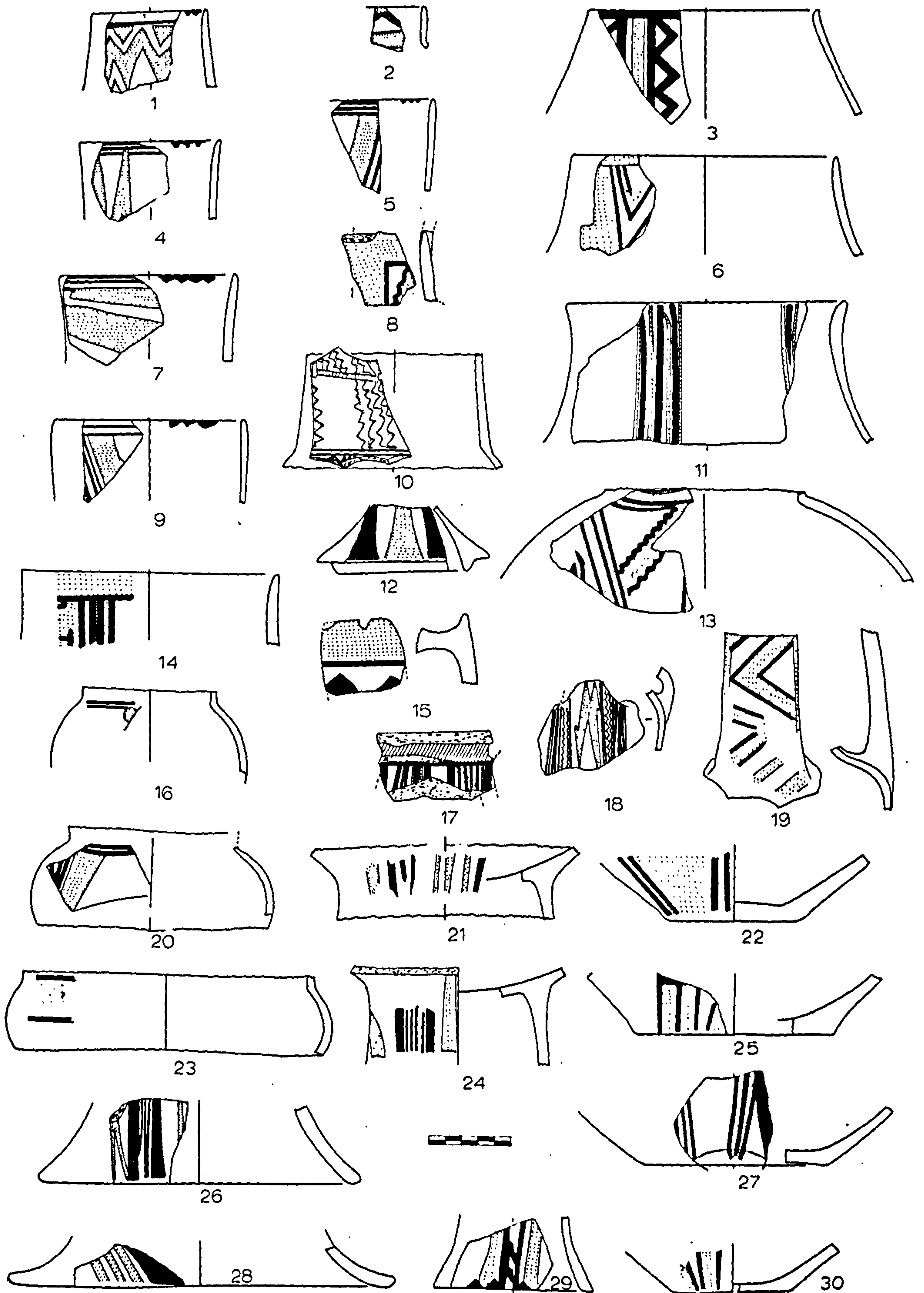
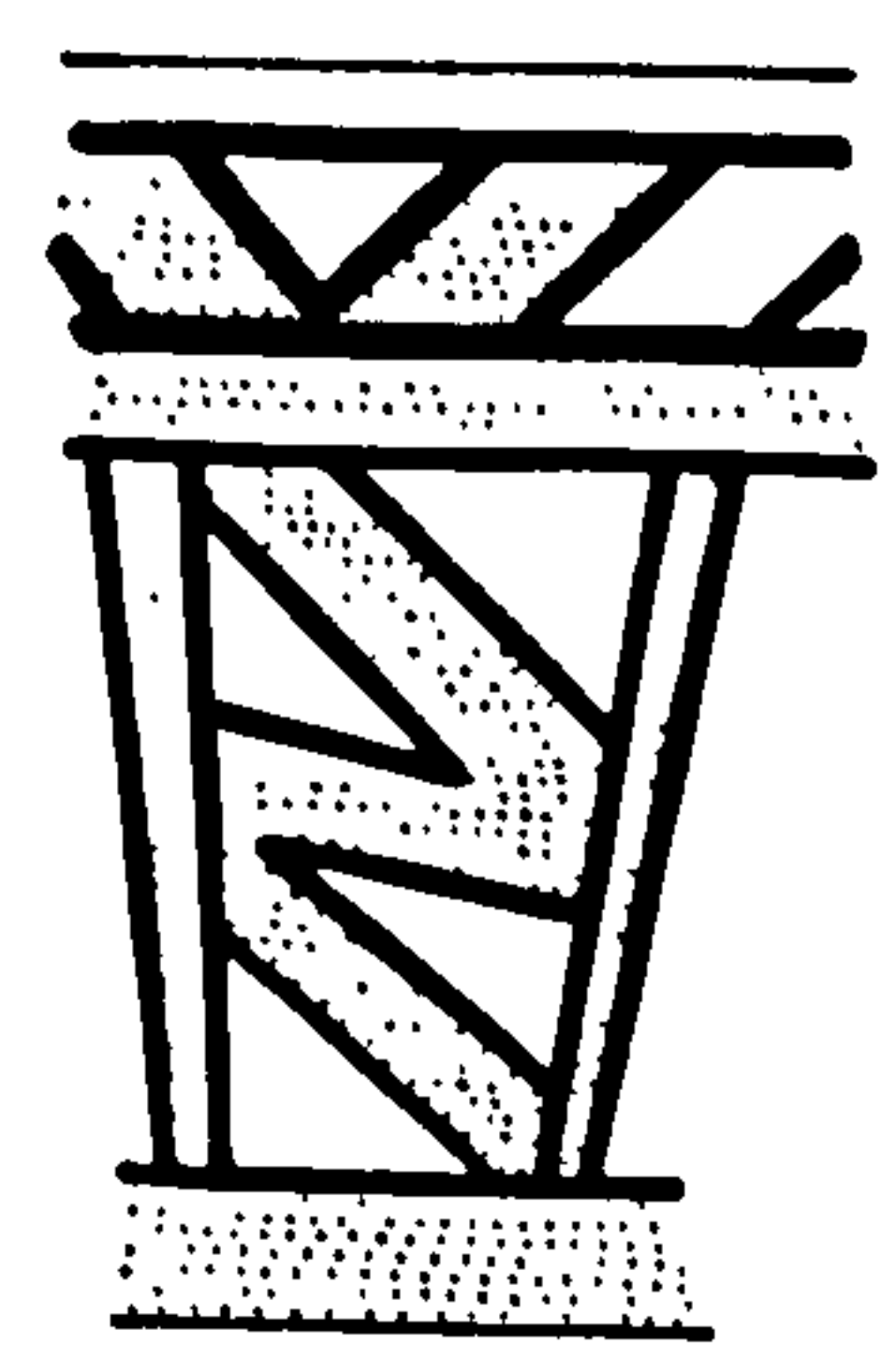
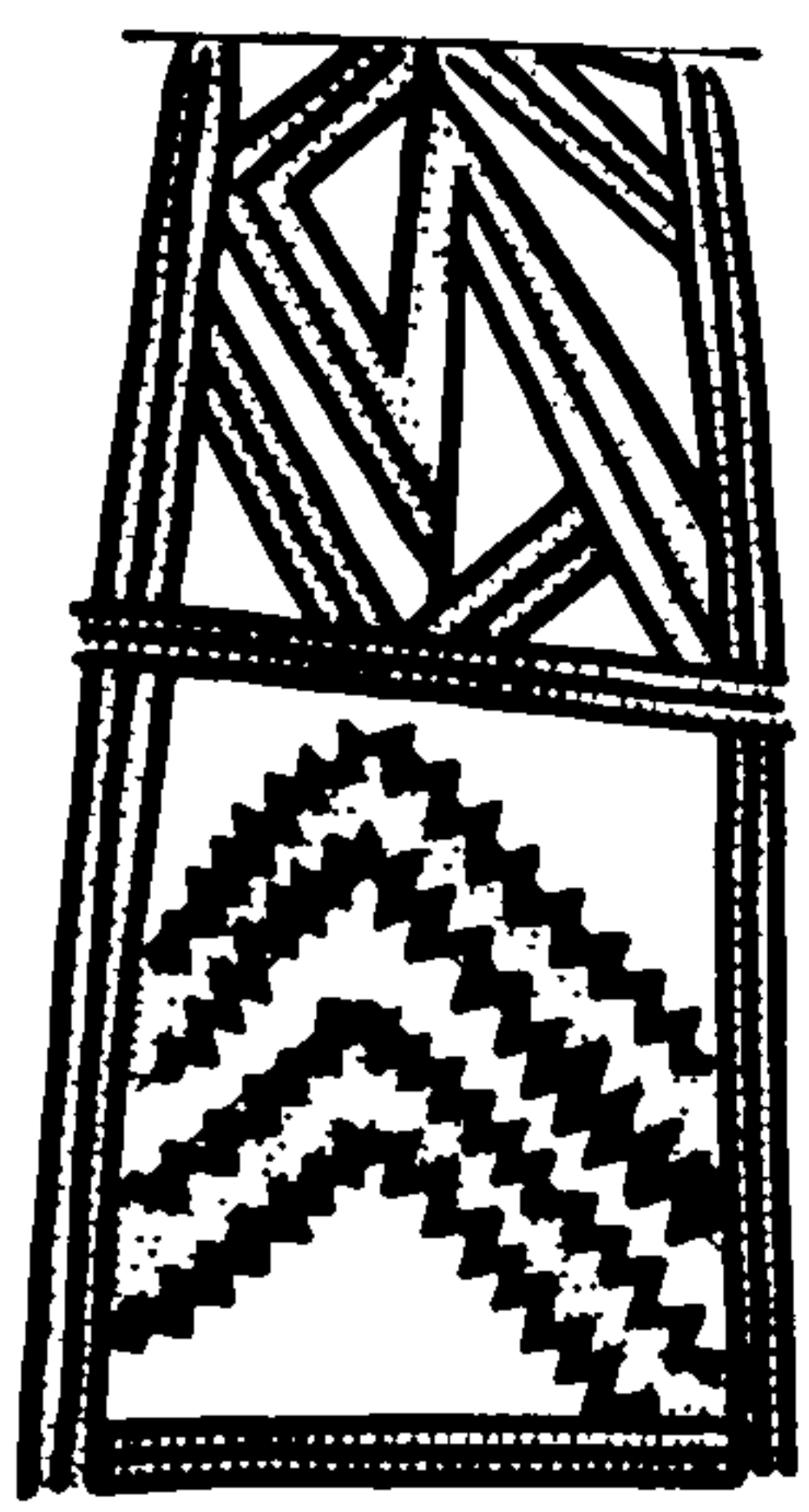
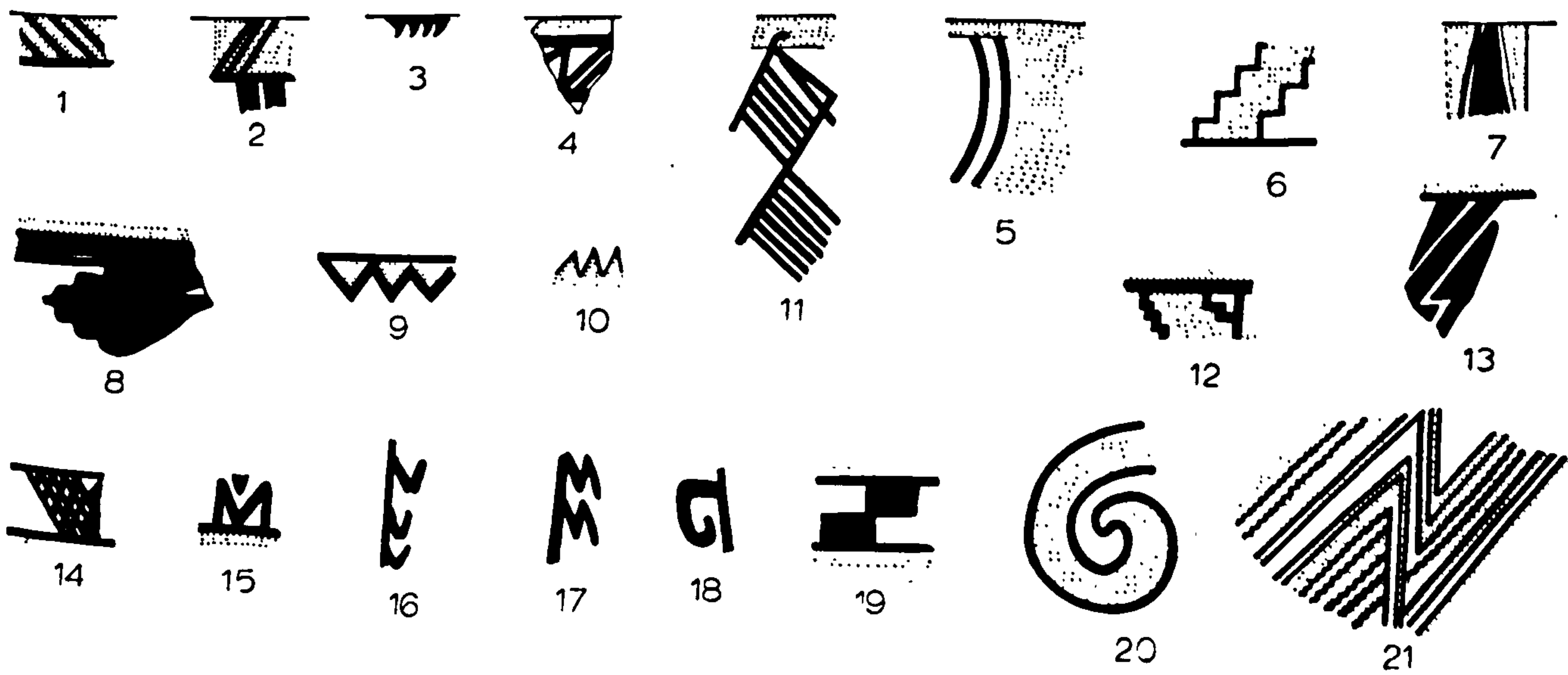

Fig 45



24

22

23

25

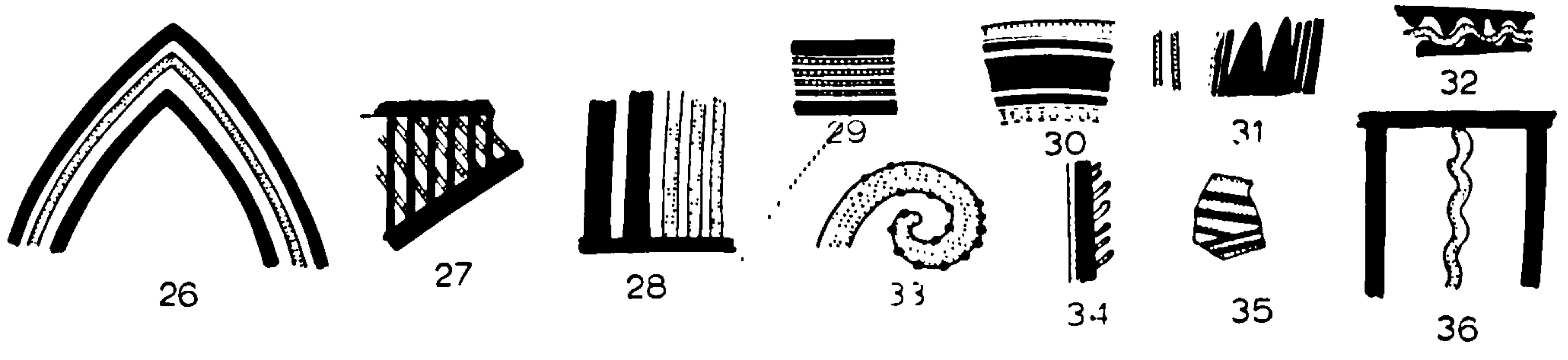

26

27

28

29

30

31

32

33

34

35

36

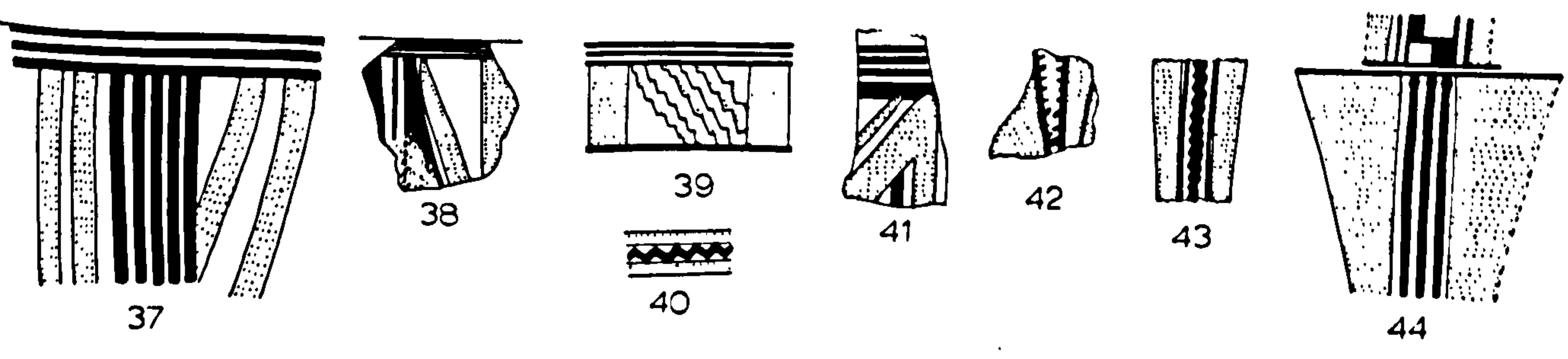

37

38

39

40

41

42

43

44



45



46



47

Fig 46

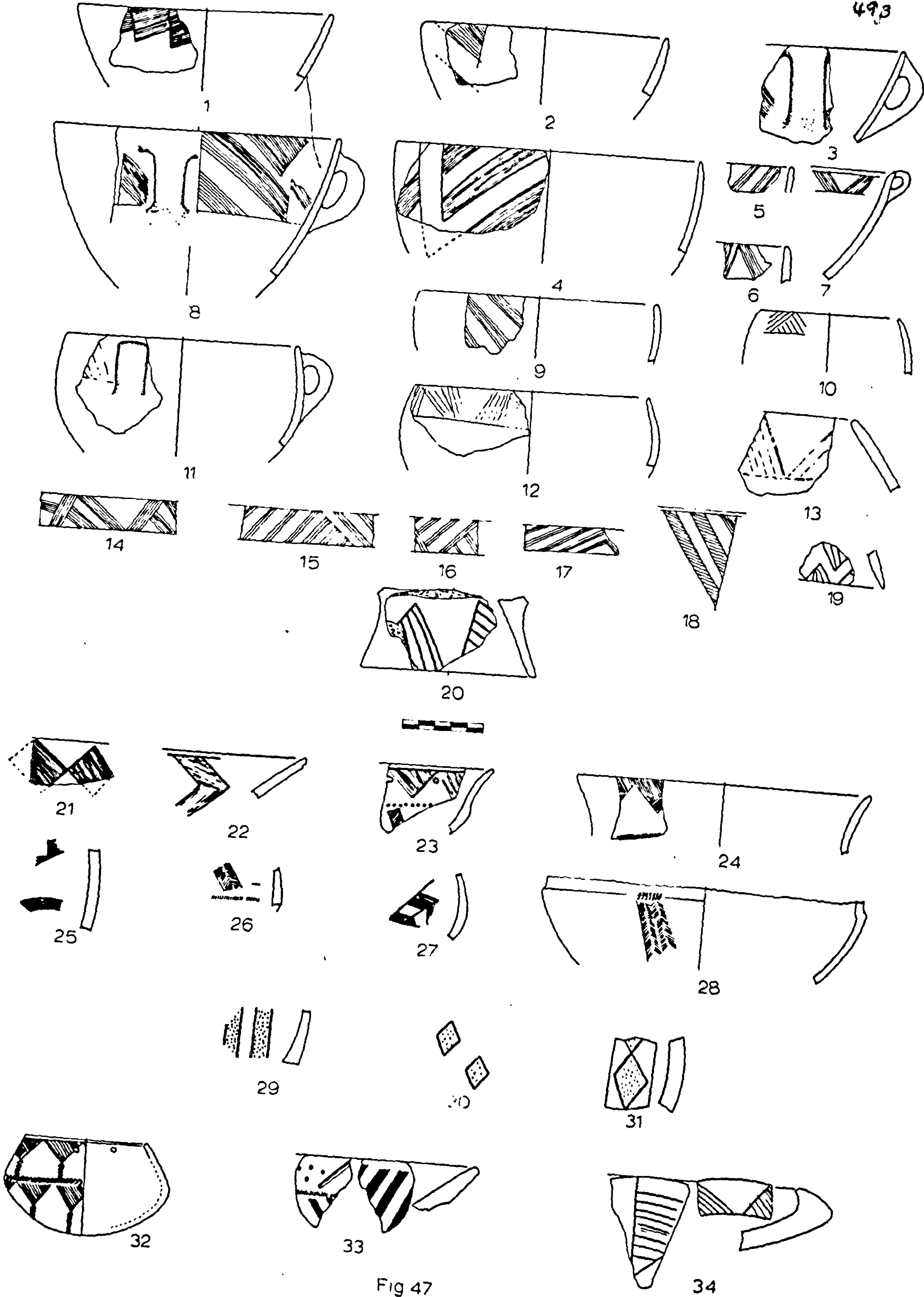

Fig 47

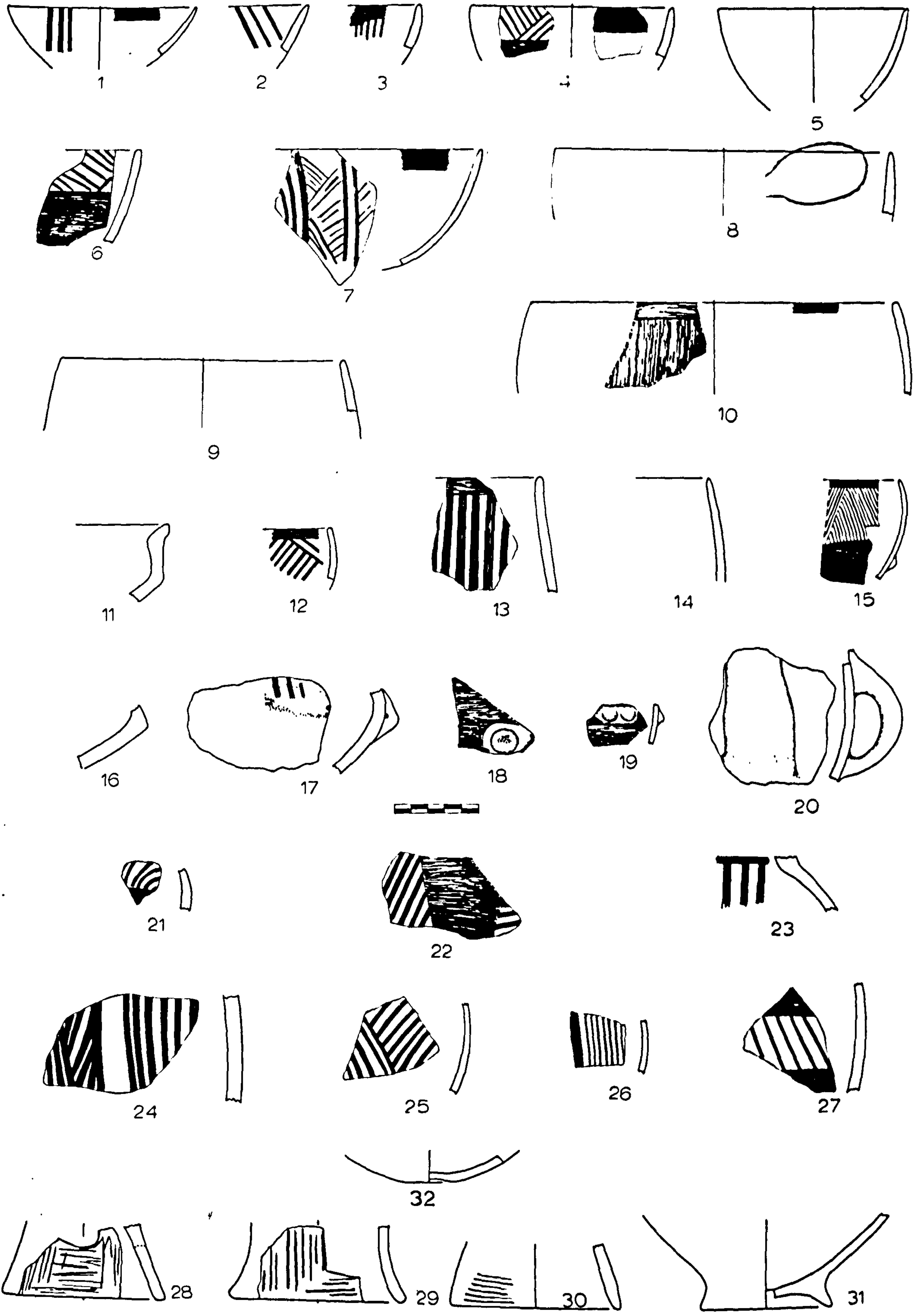
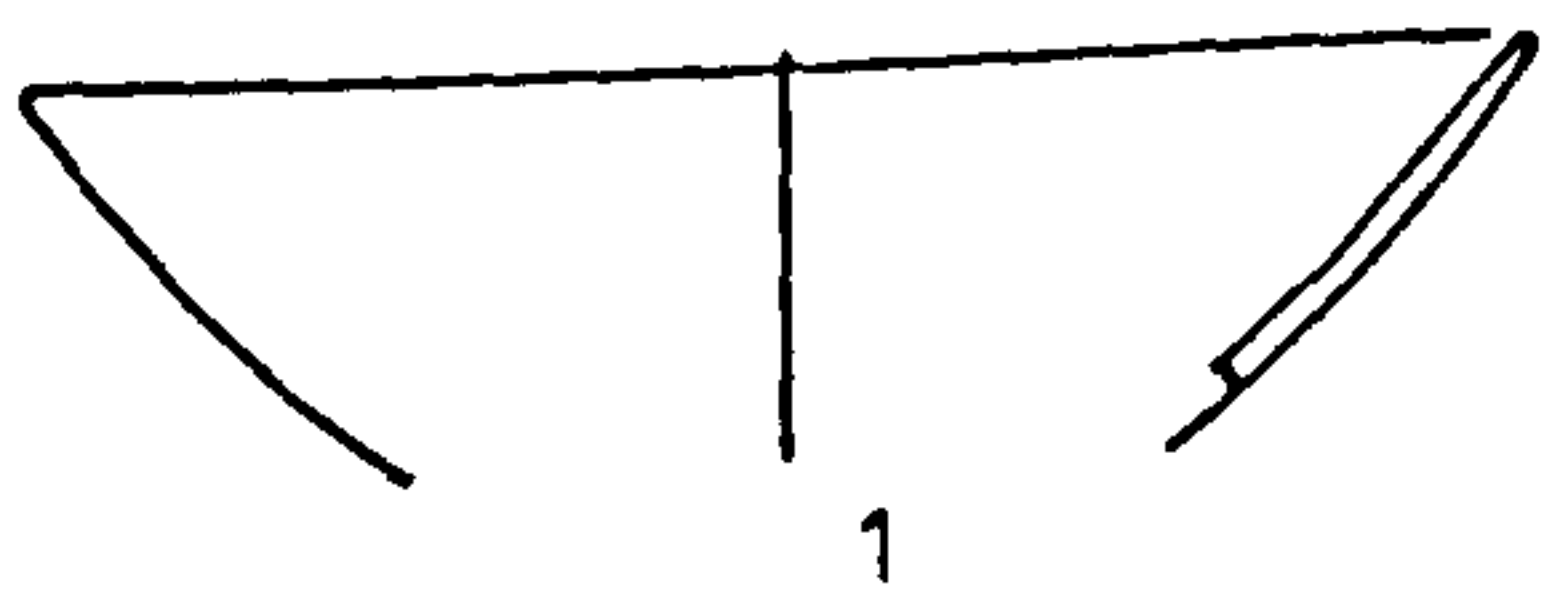
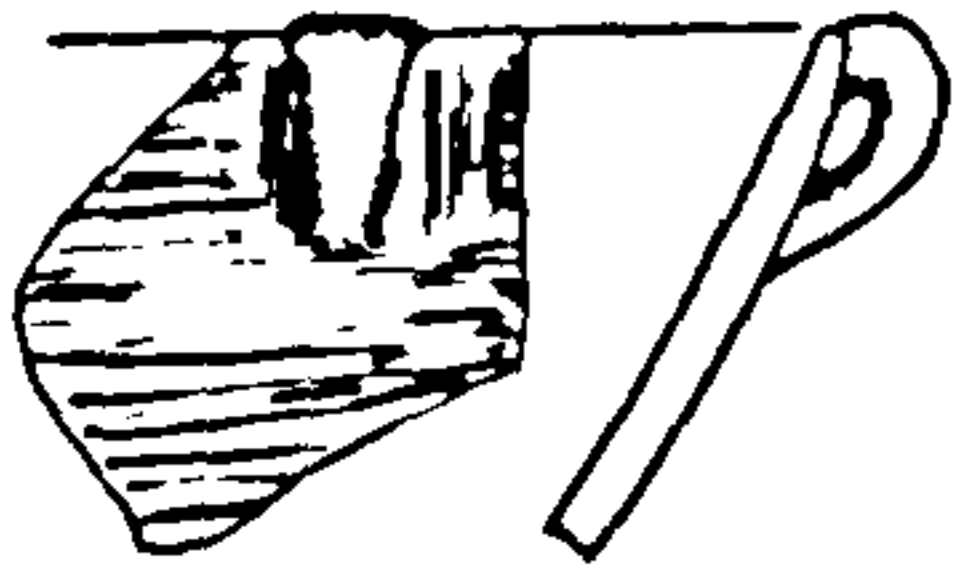

Fig 48



1



2

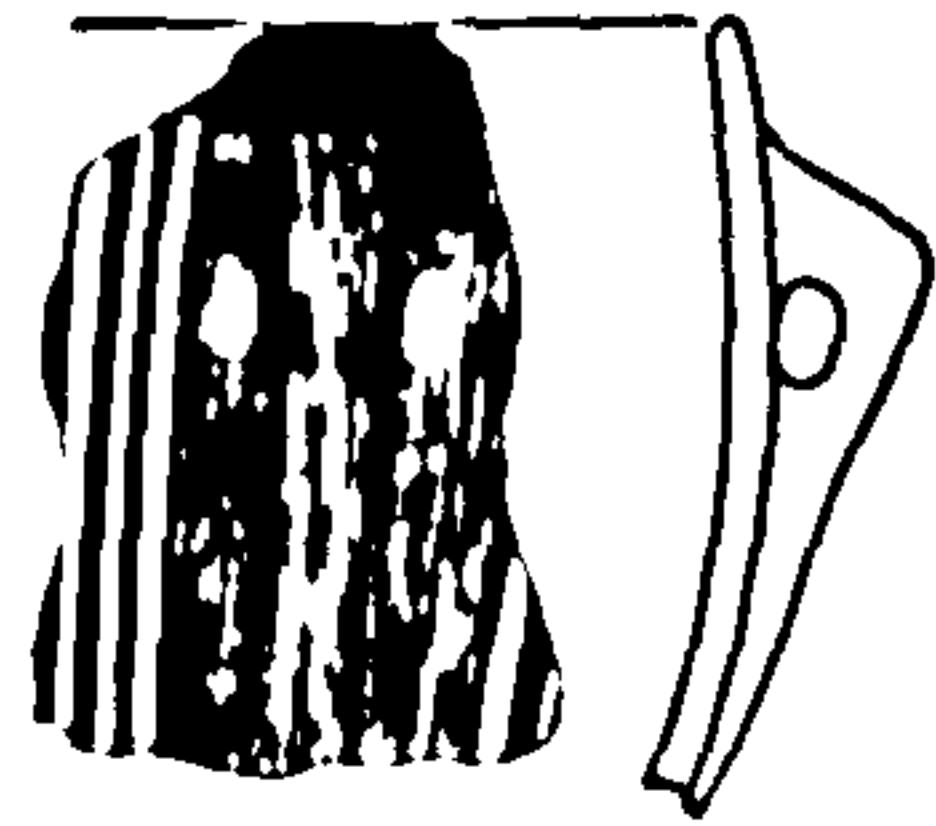

3

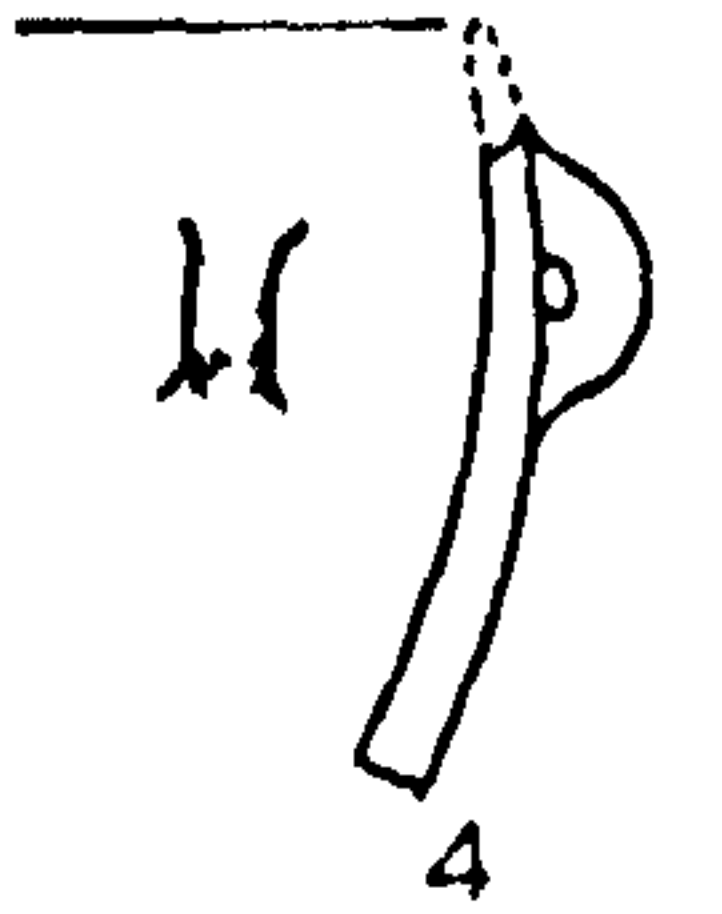

4



5

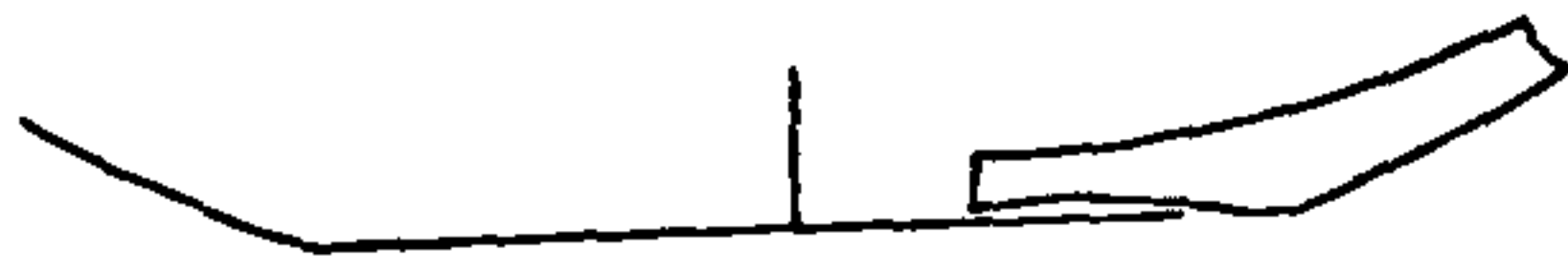

6



7



8

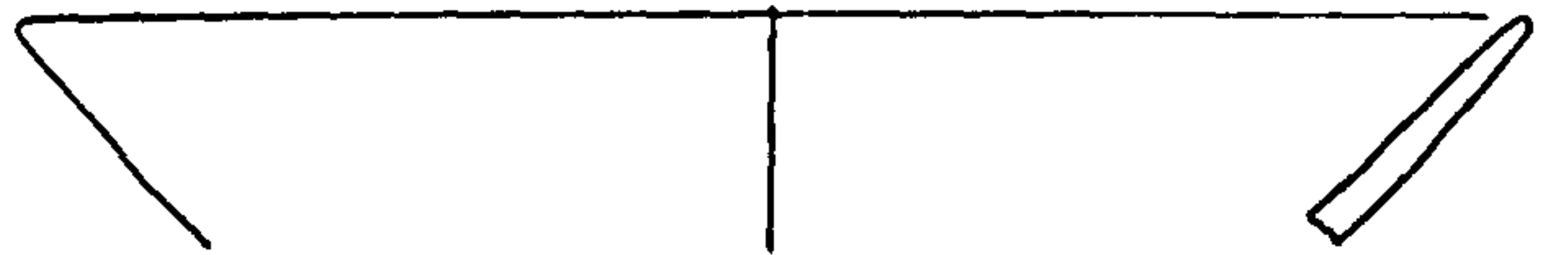

9

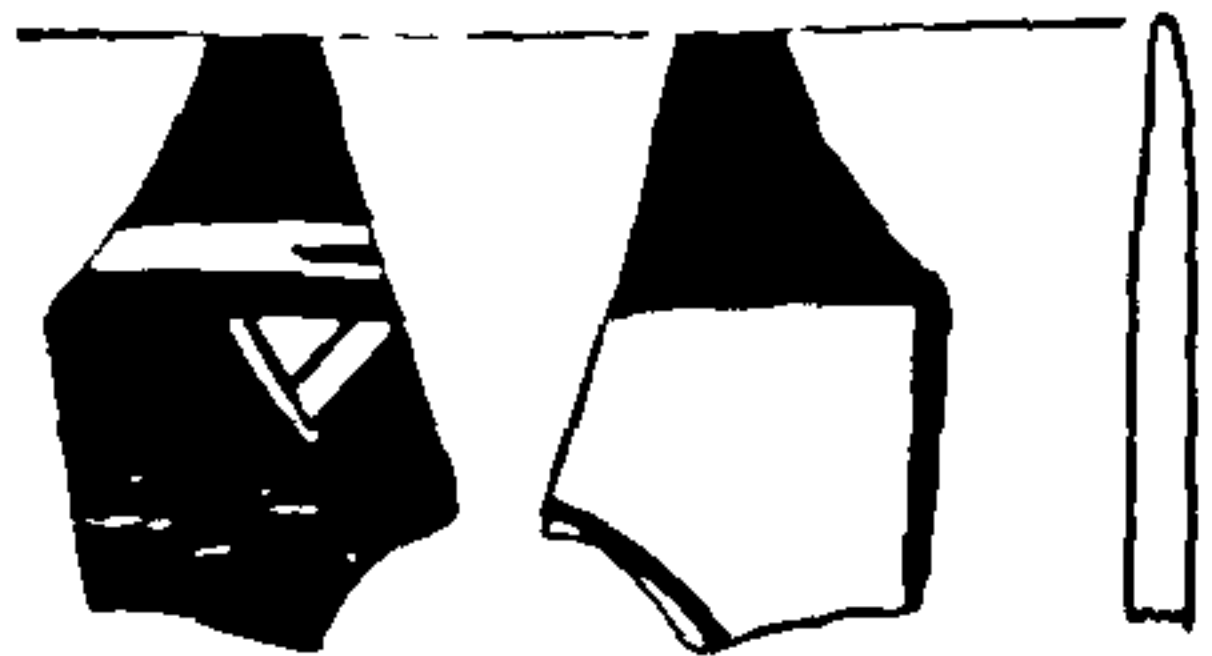

10

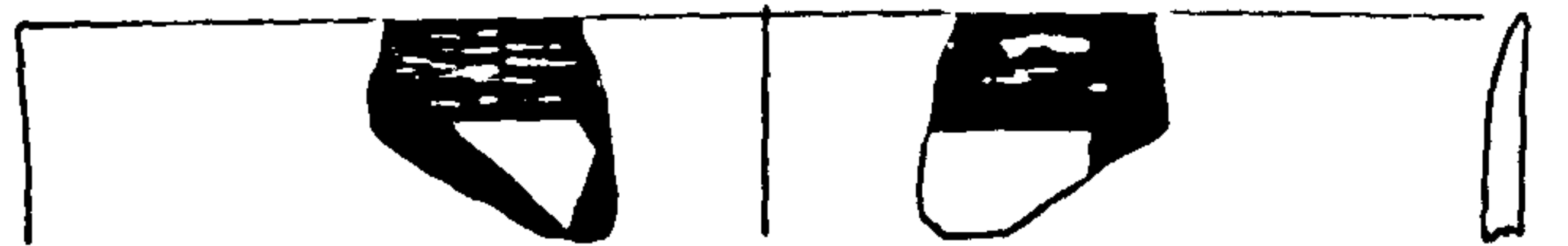

11

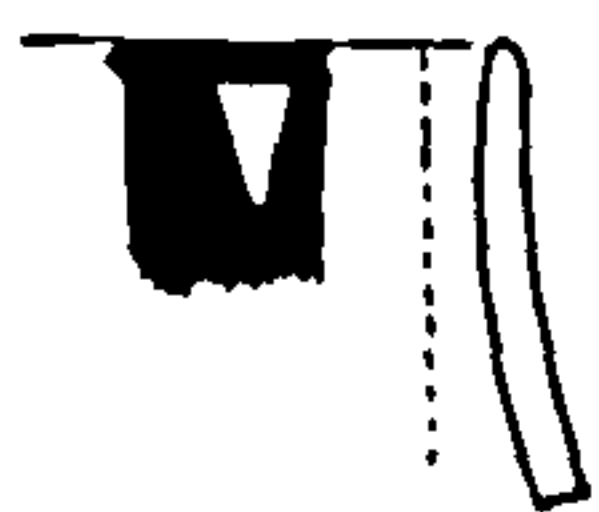

12



13

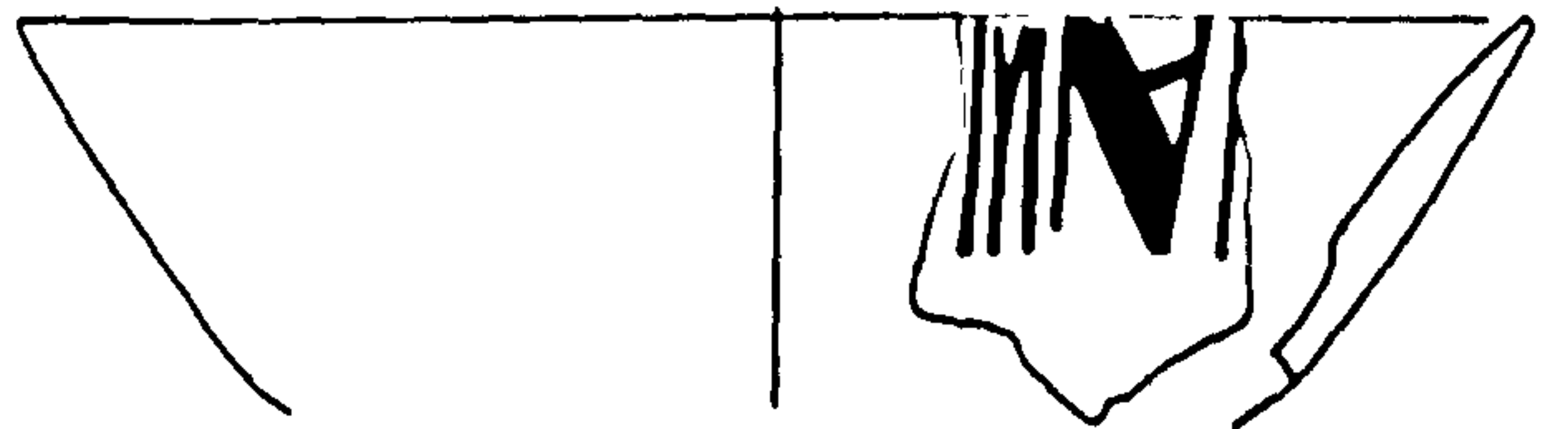

14



15



16

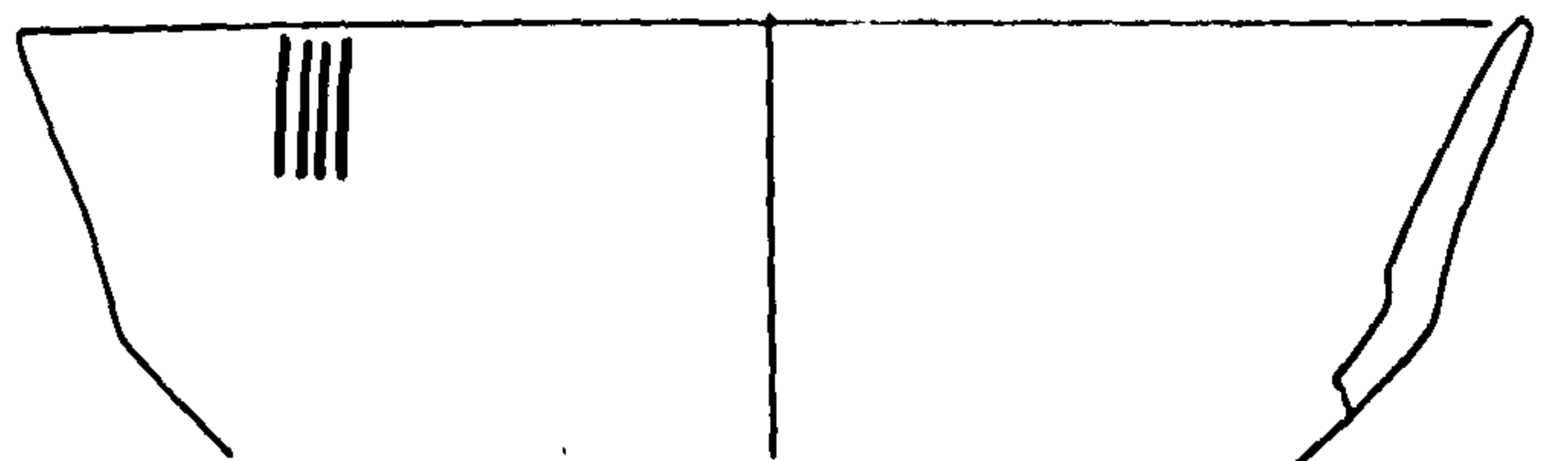

17

Fig 49

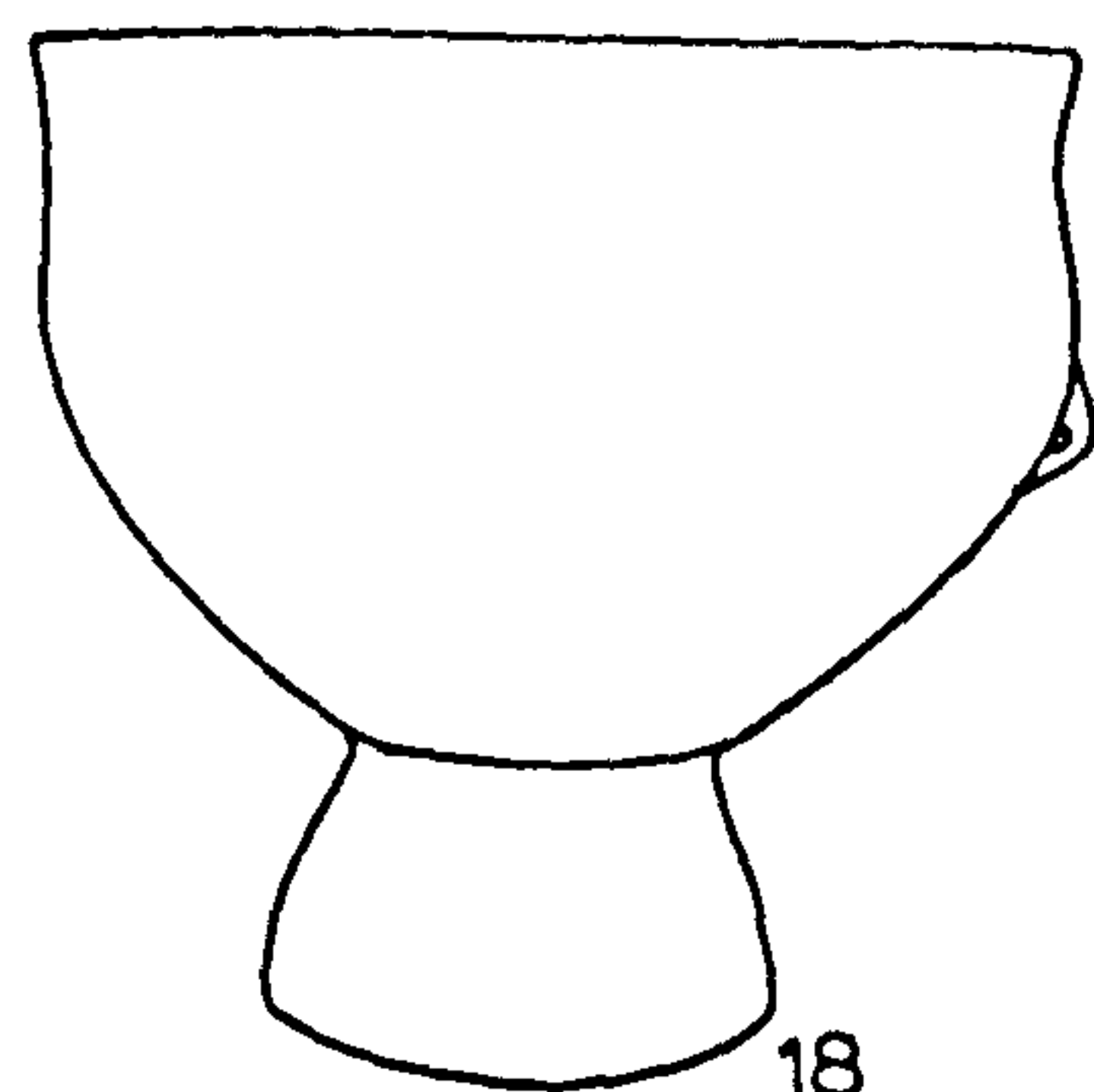
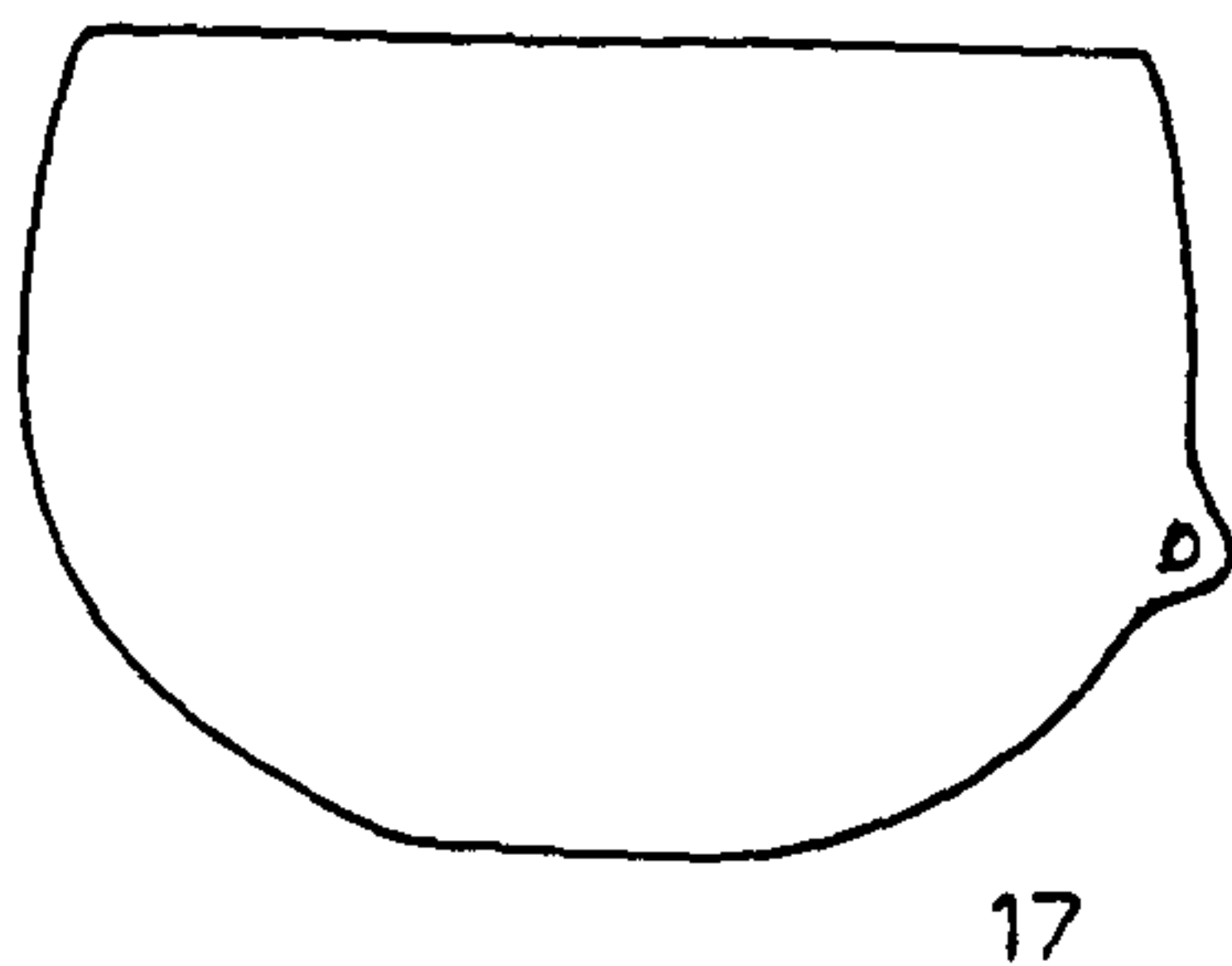
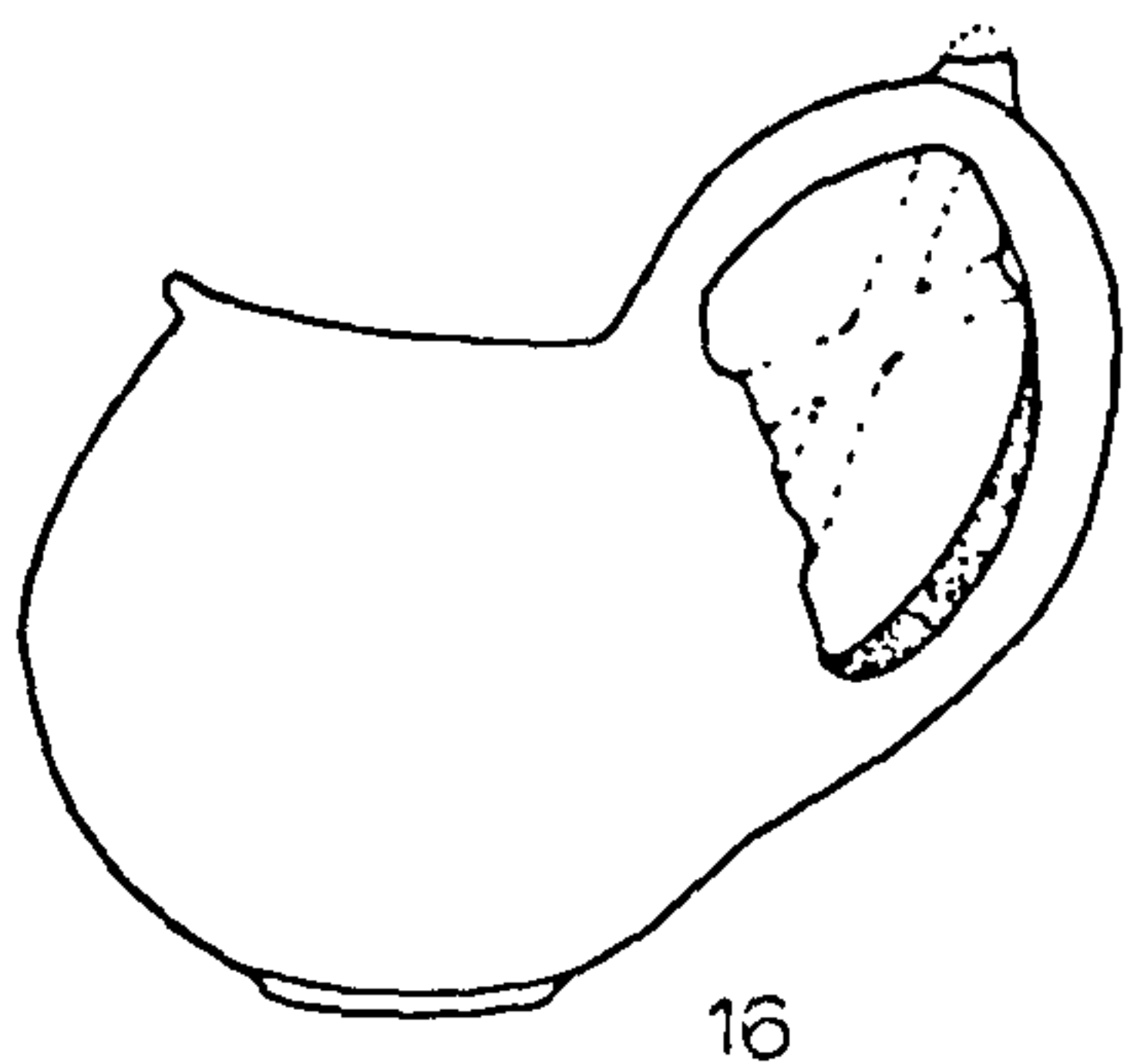
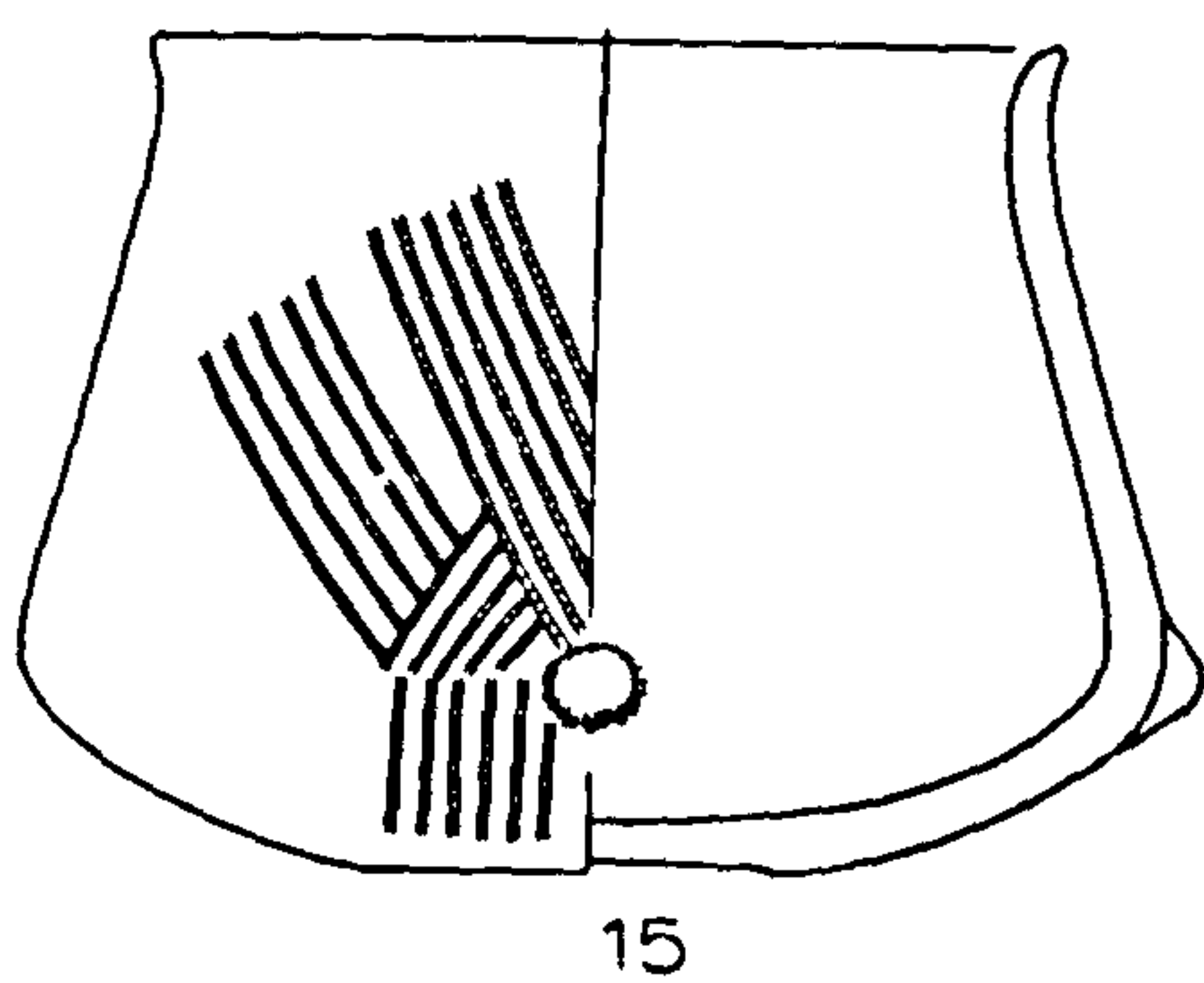
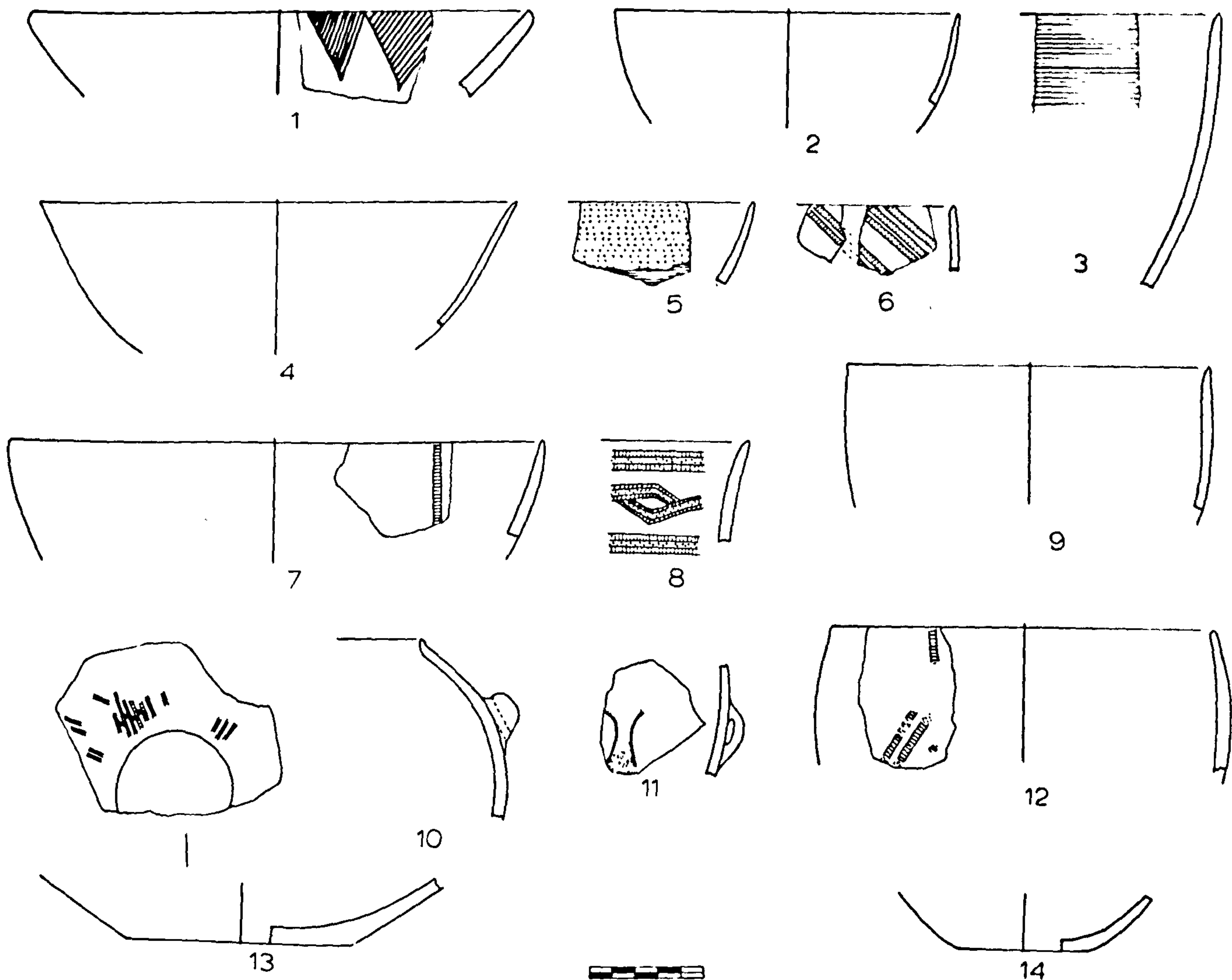

Fig 50

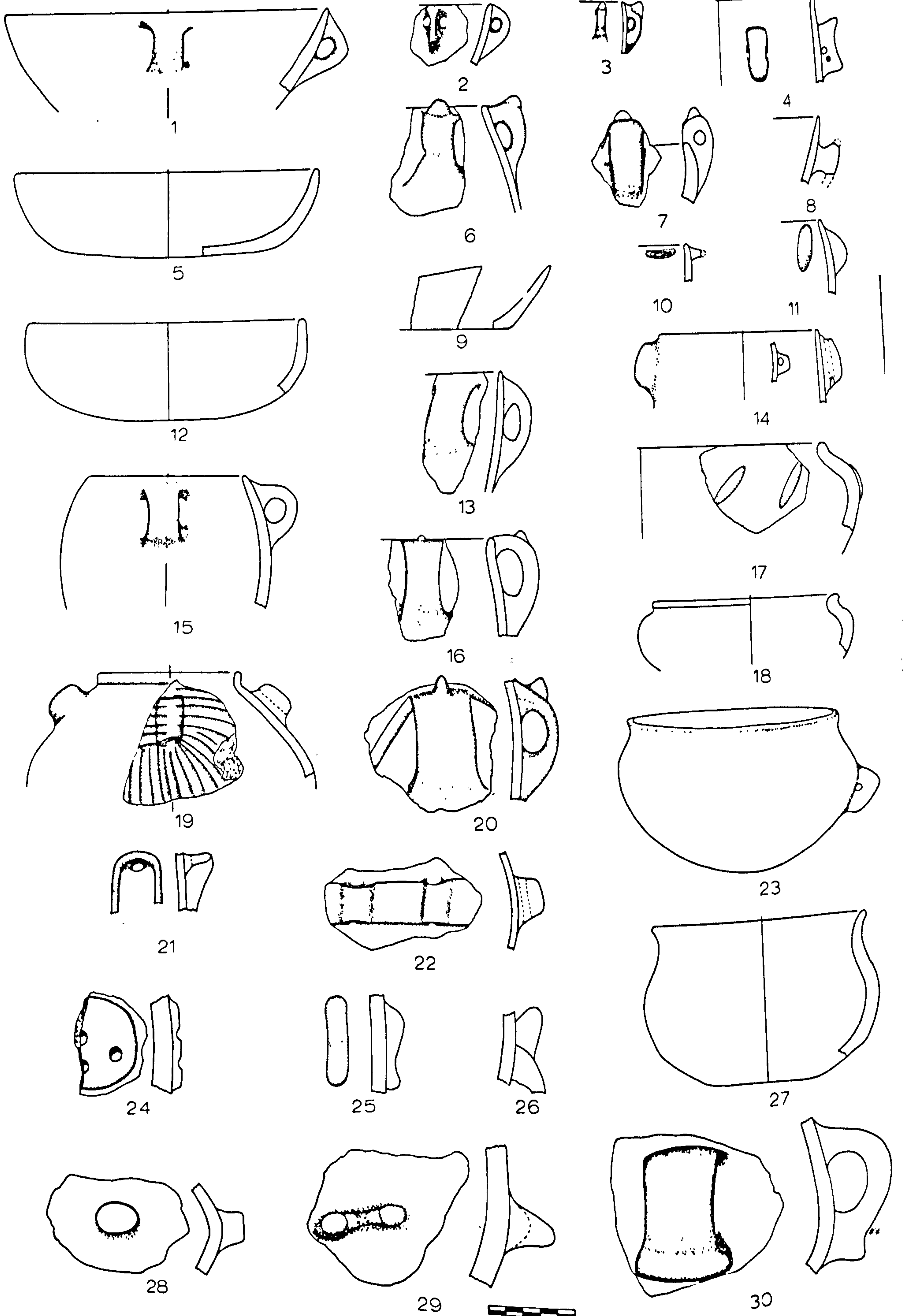
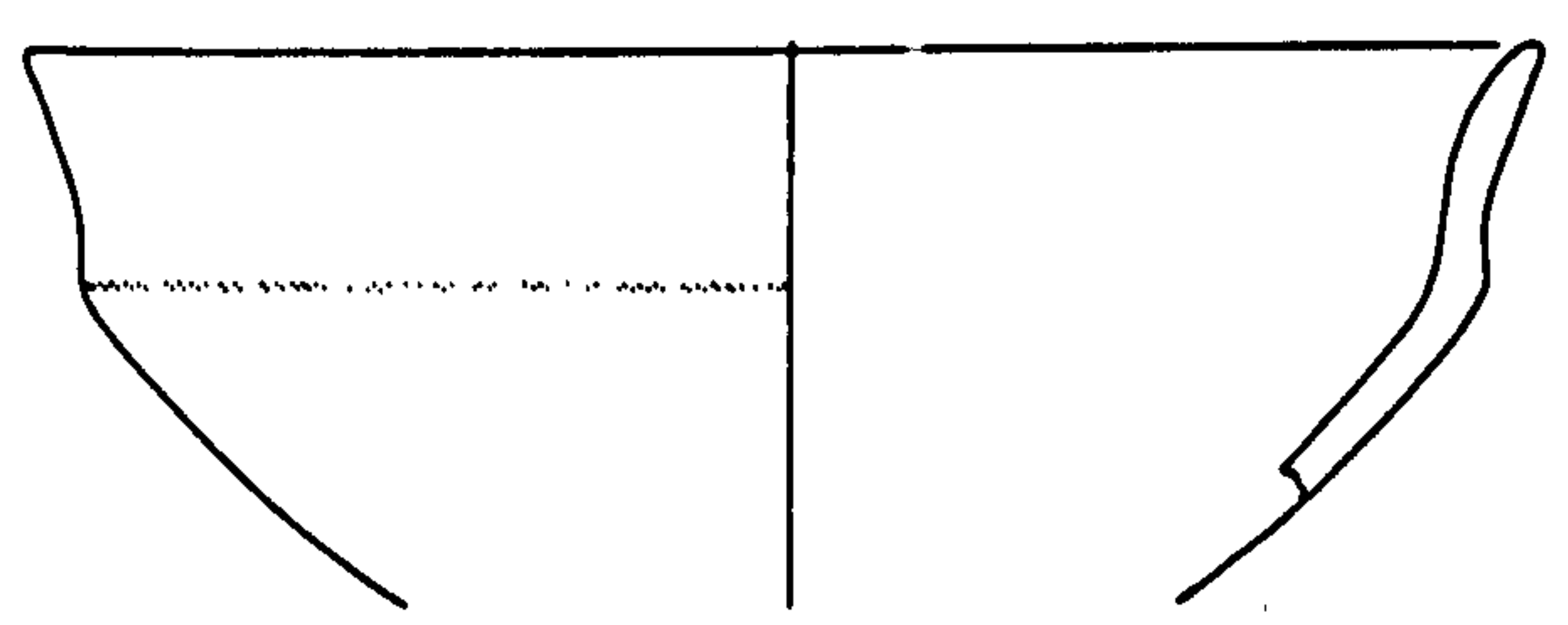
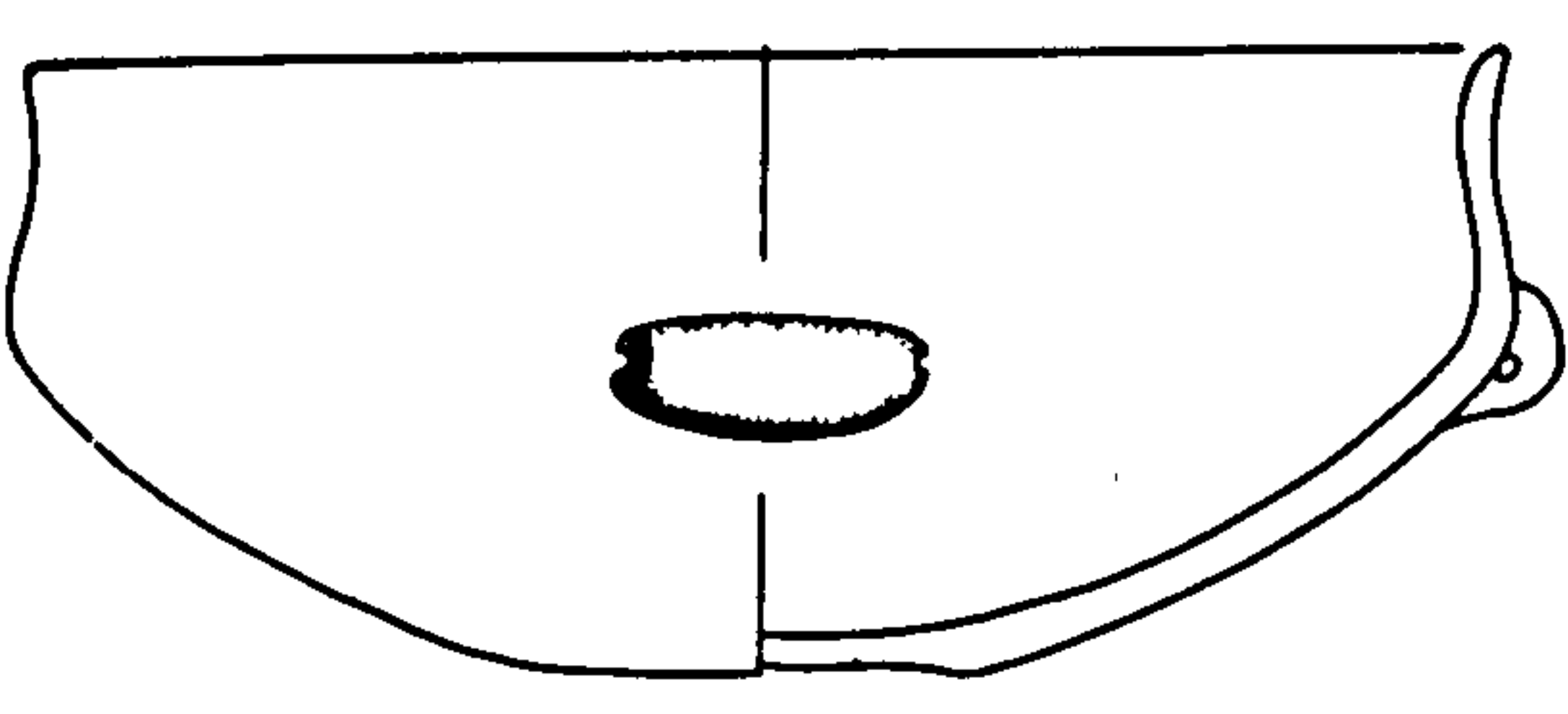
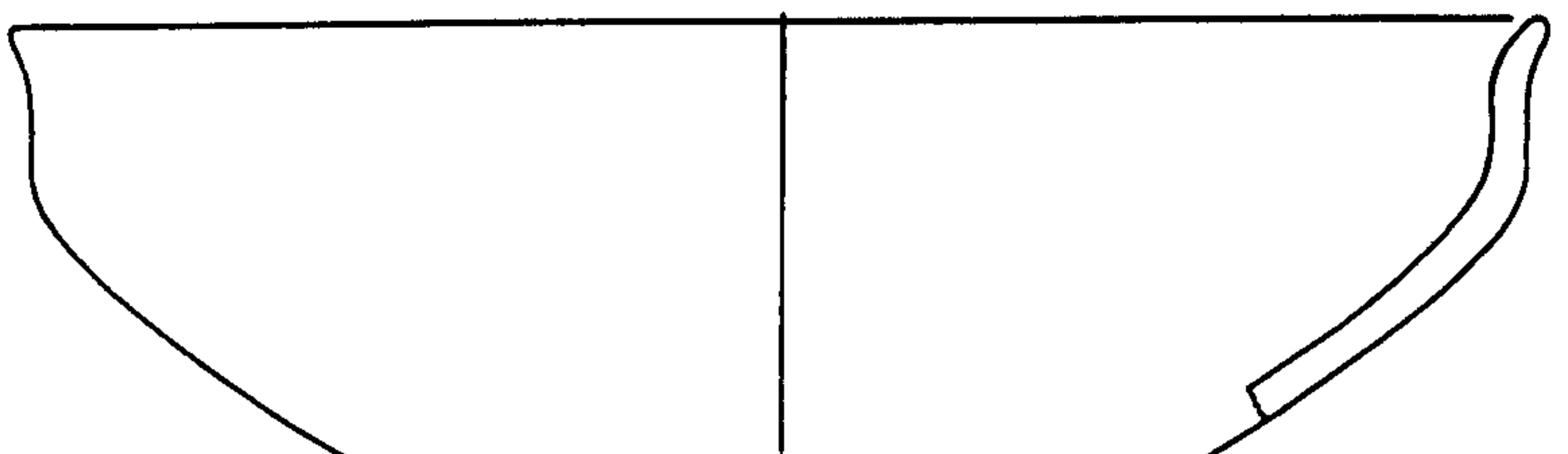
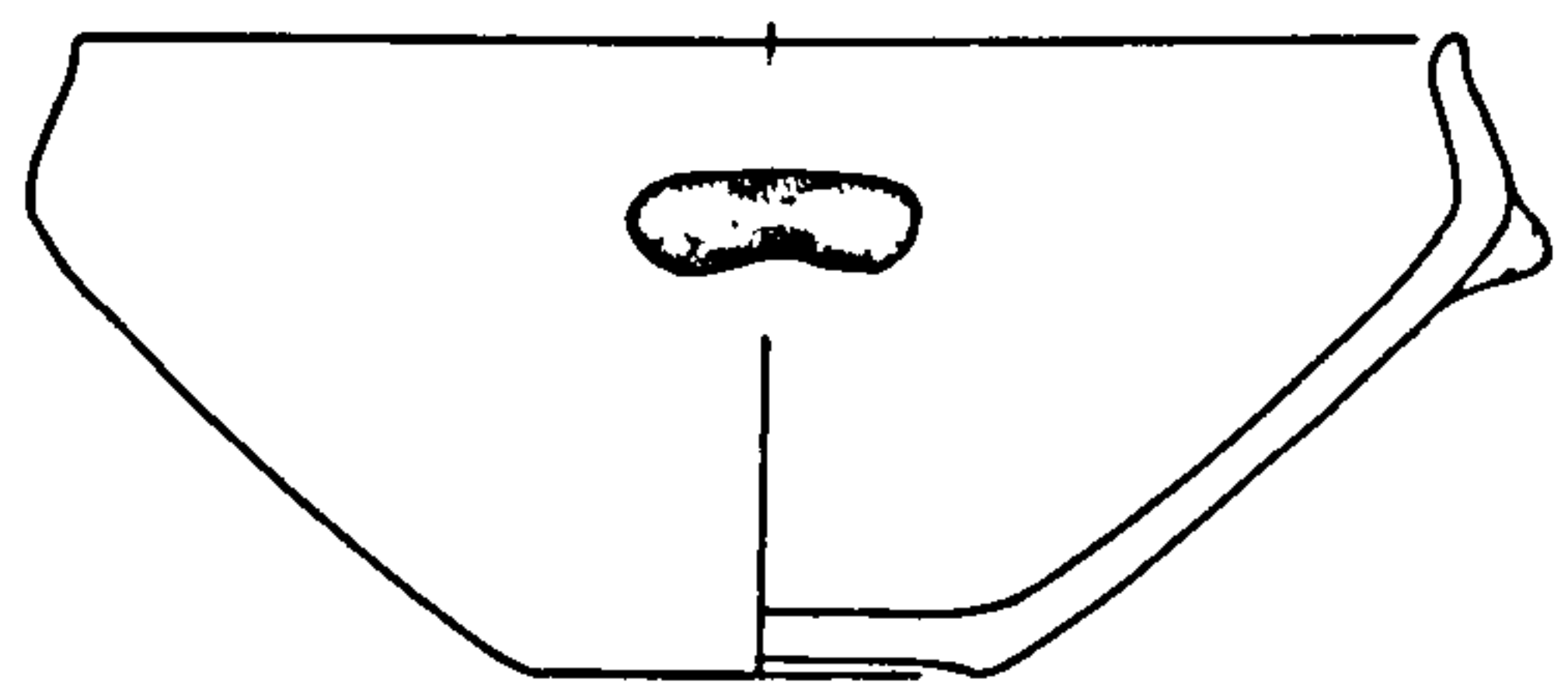

Fig 51



1

2



3

4

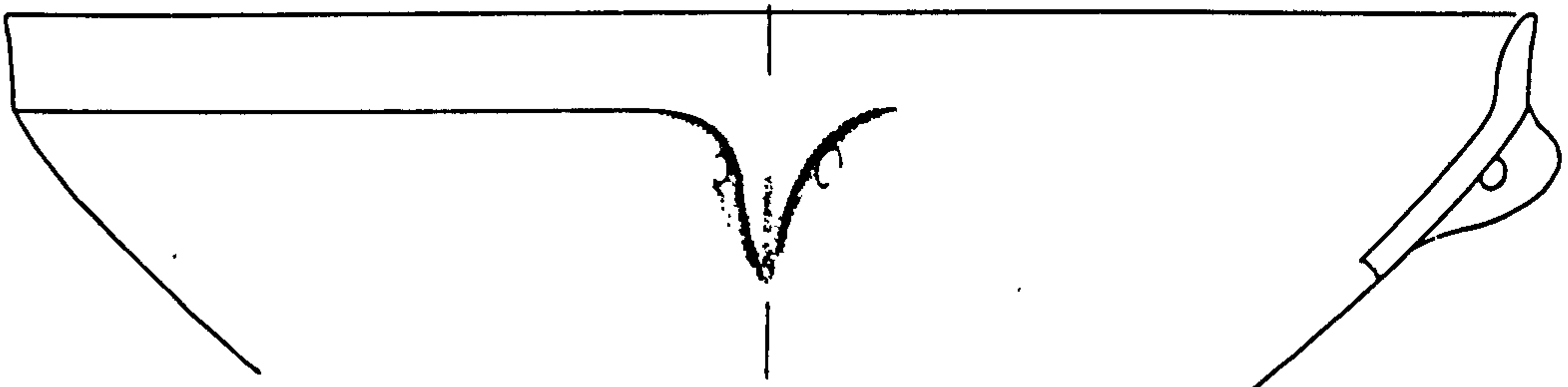

5

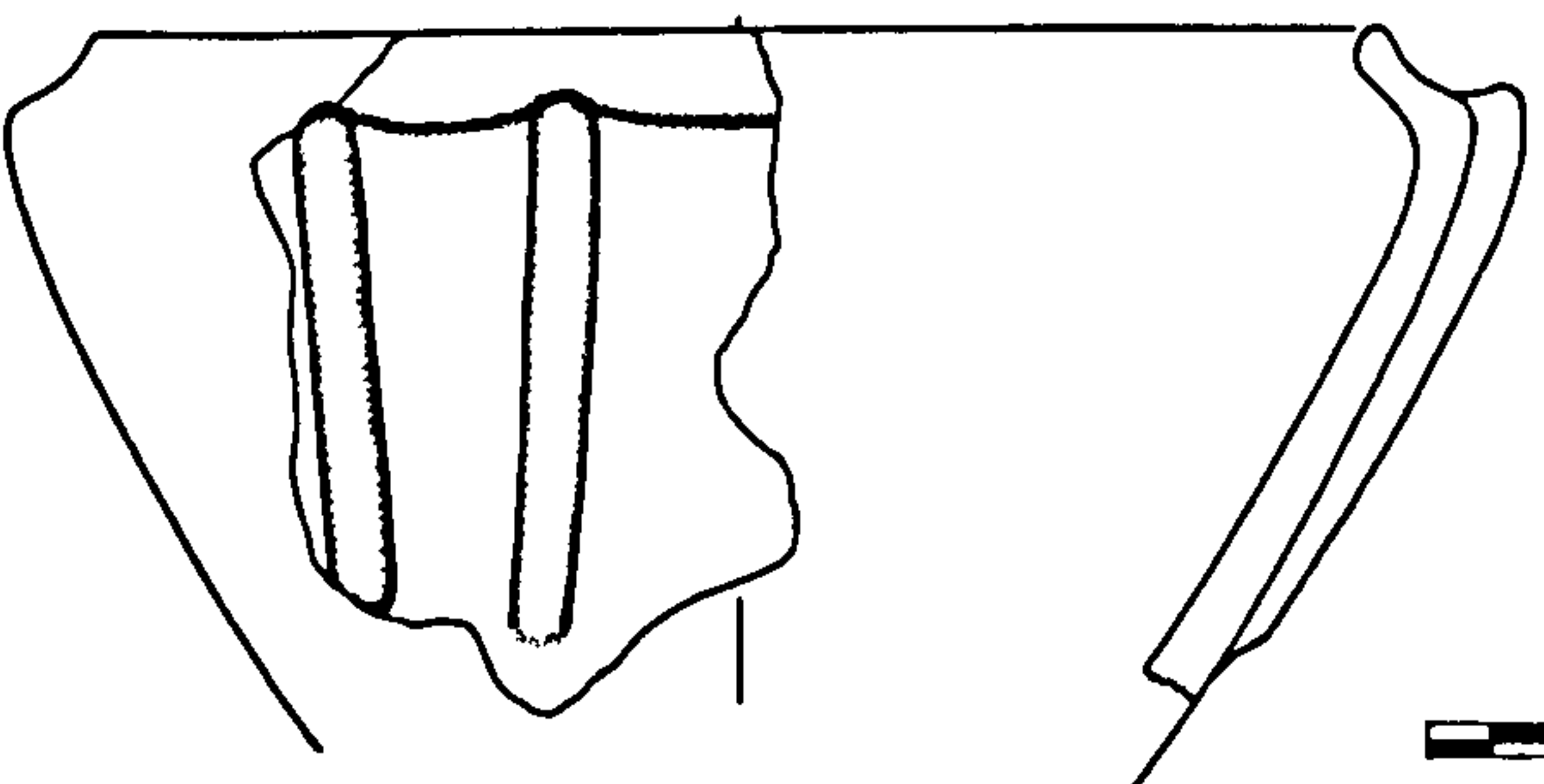

6

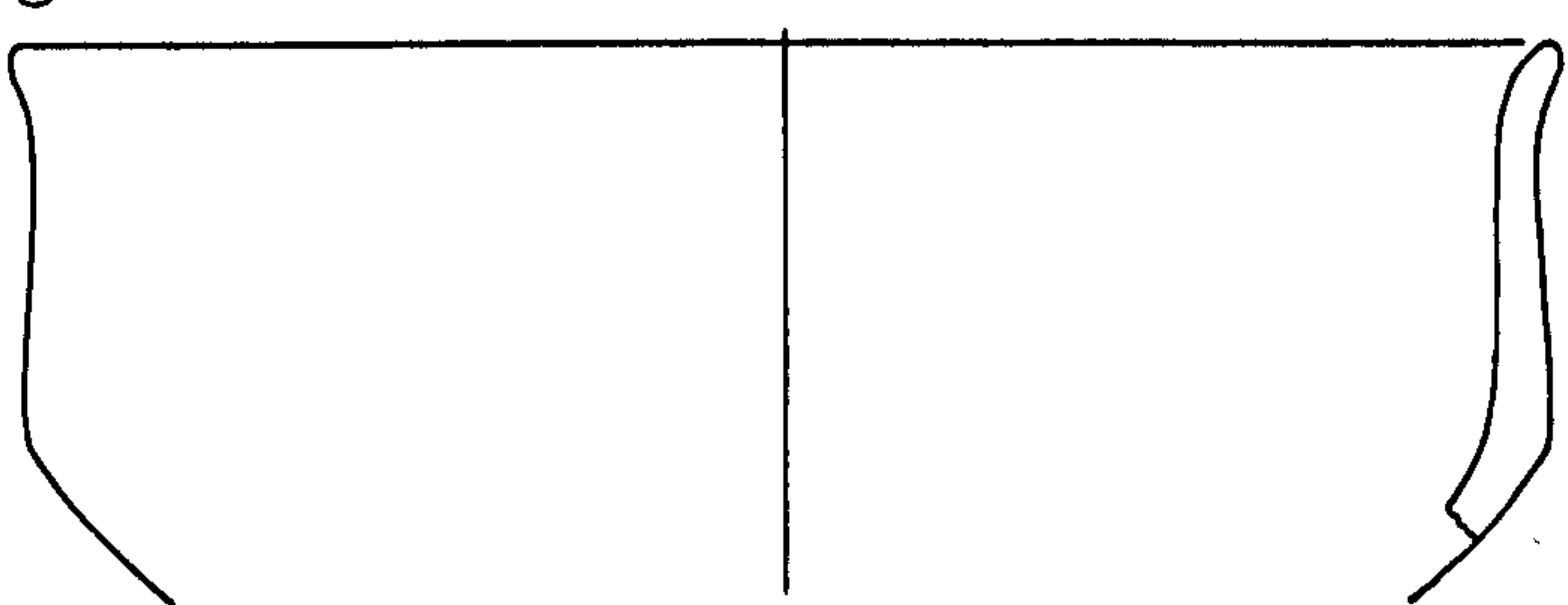

7

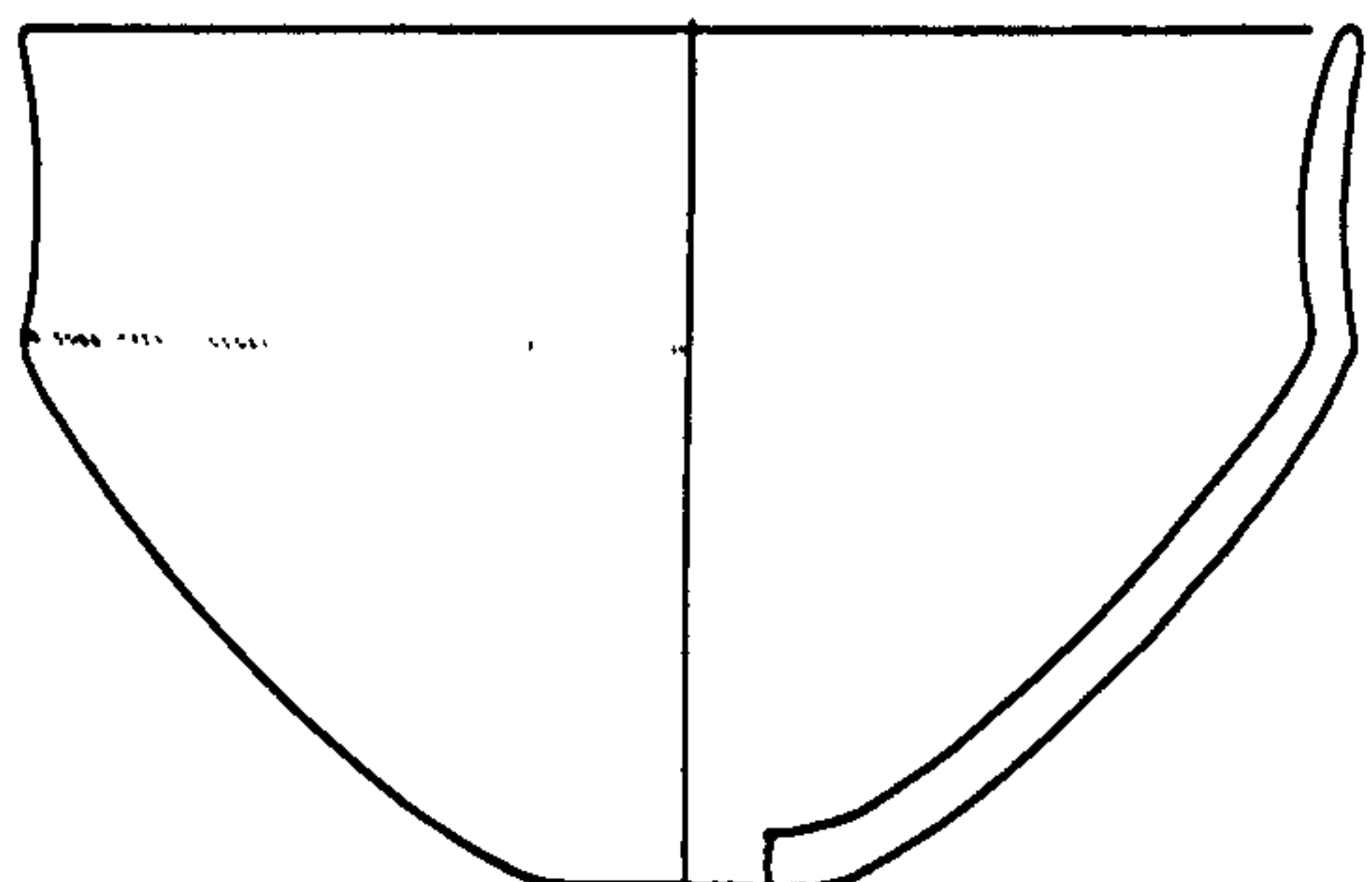

8

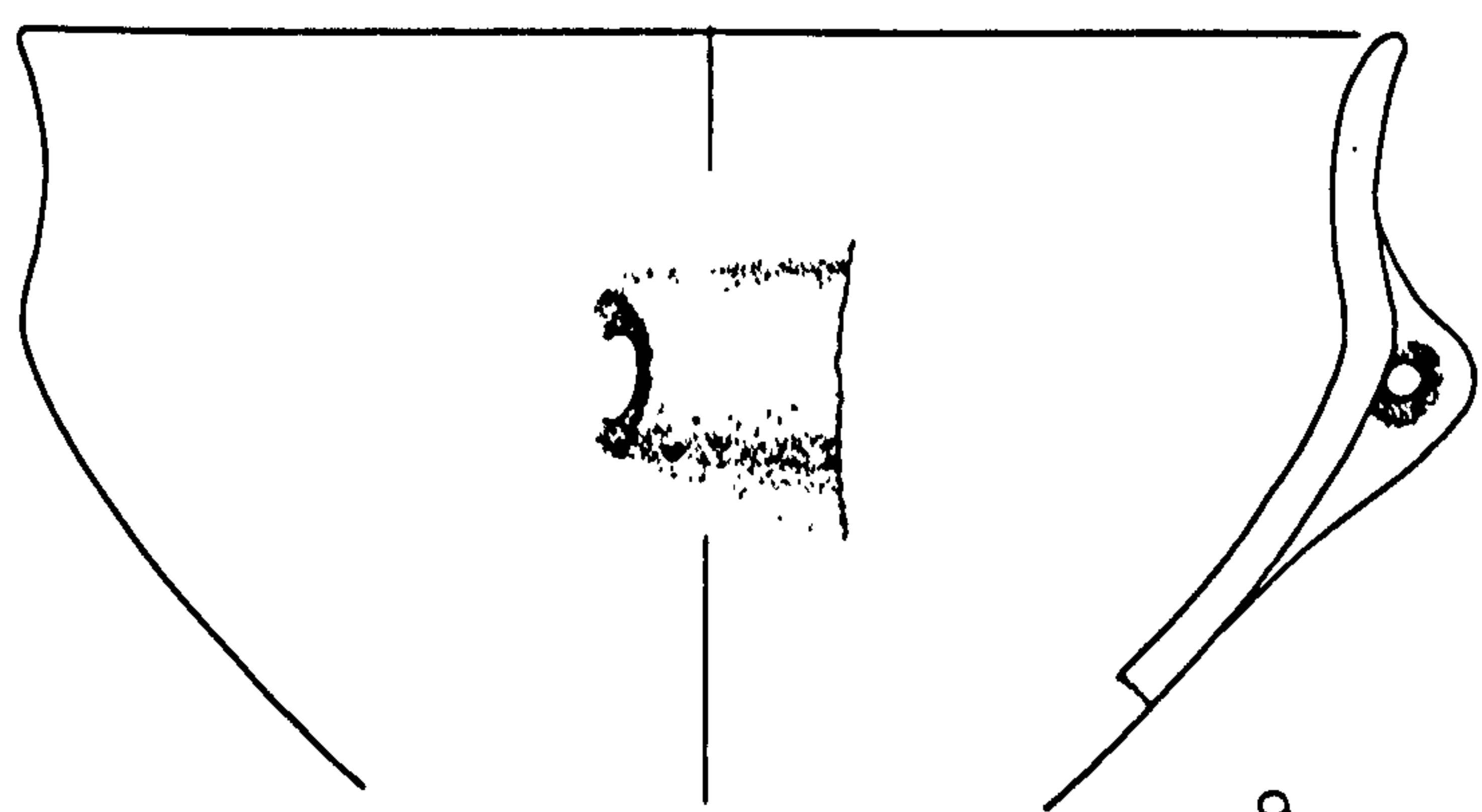

9

Fig.52

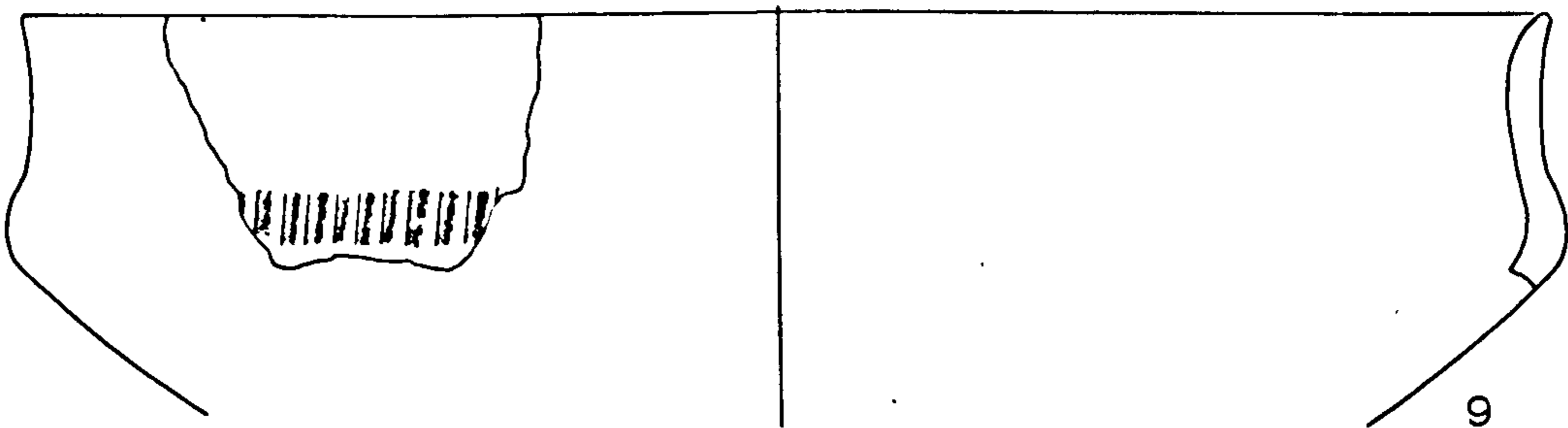
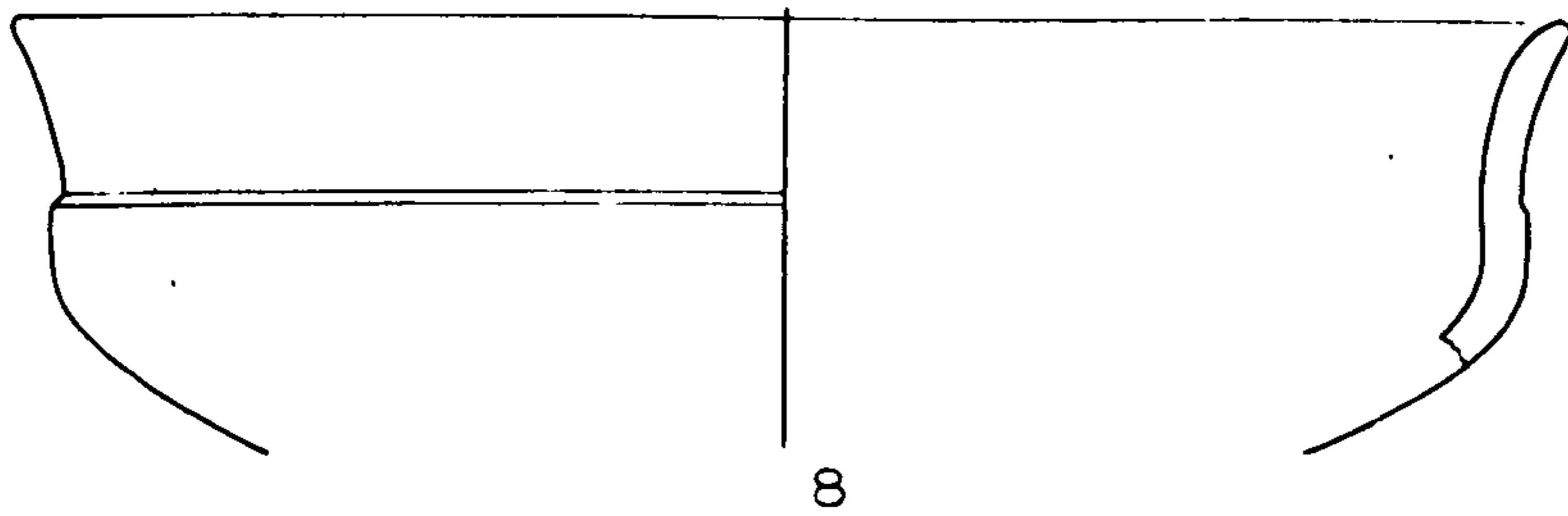
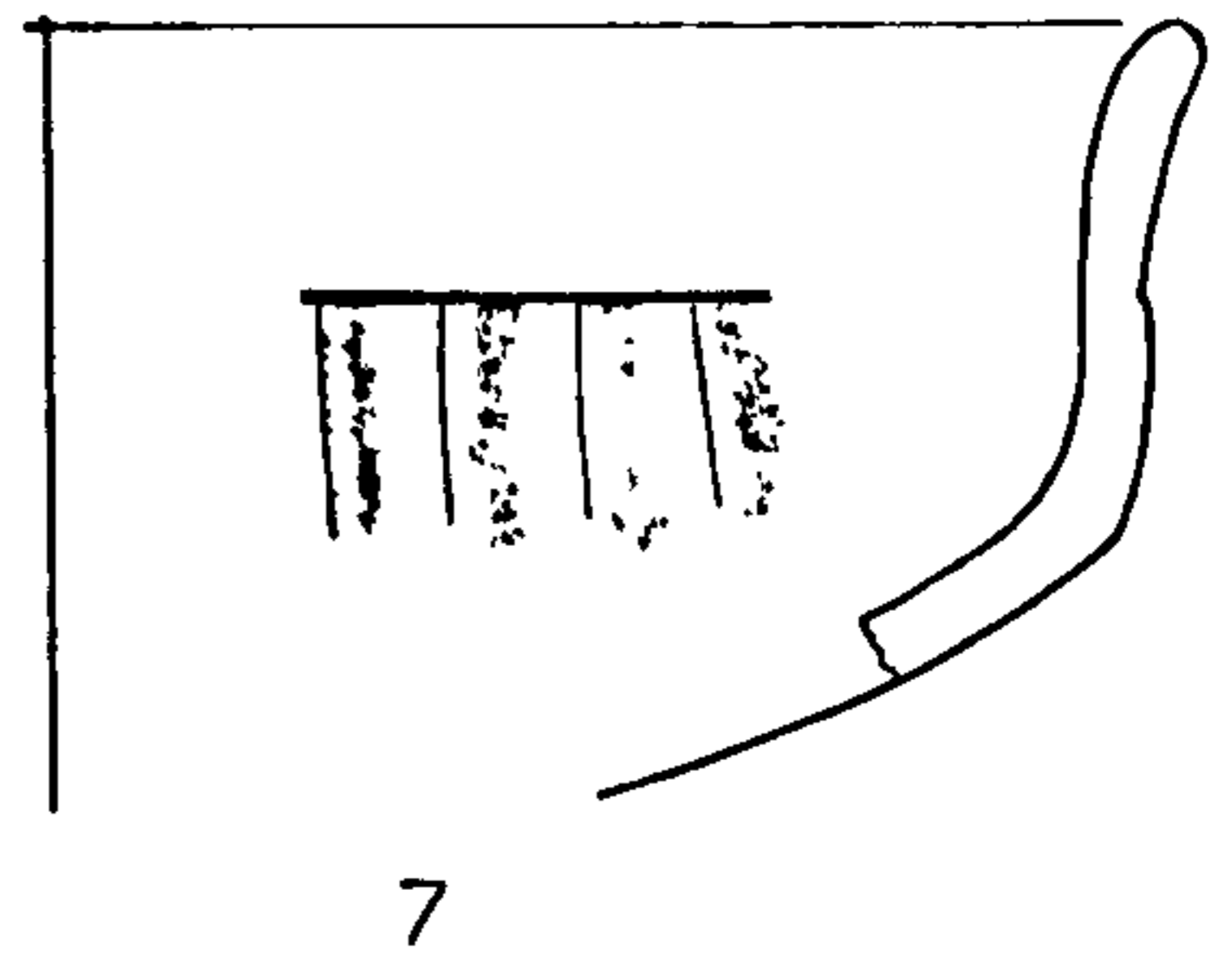
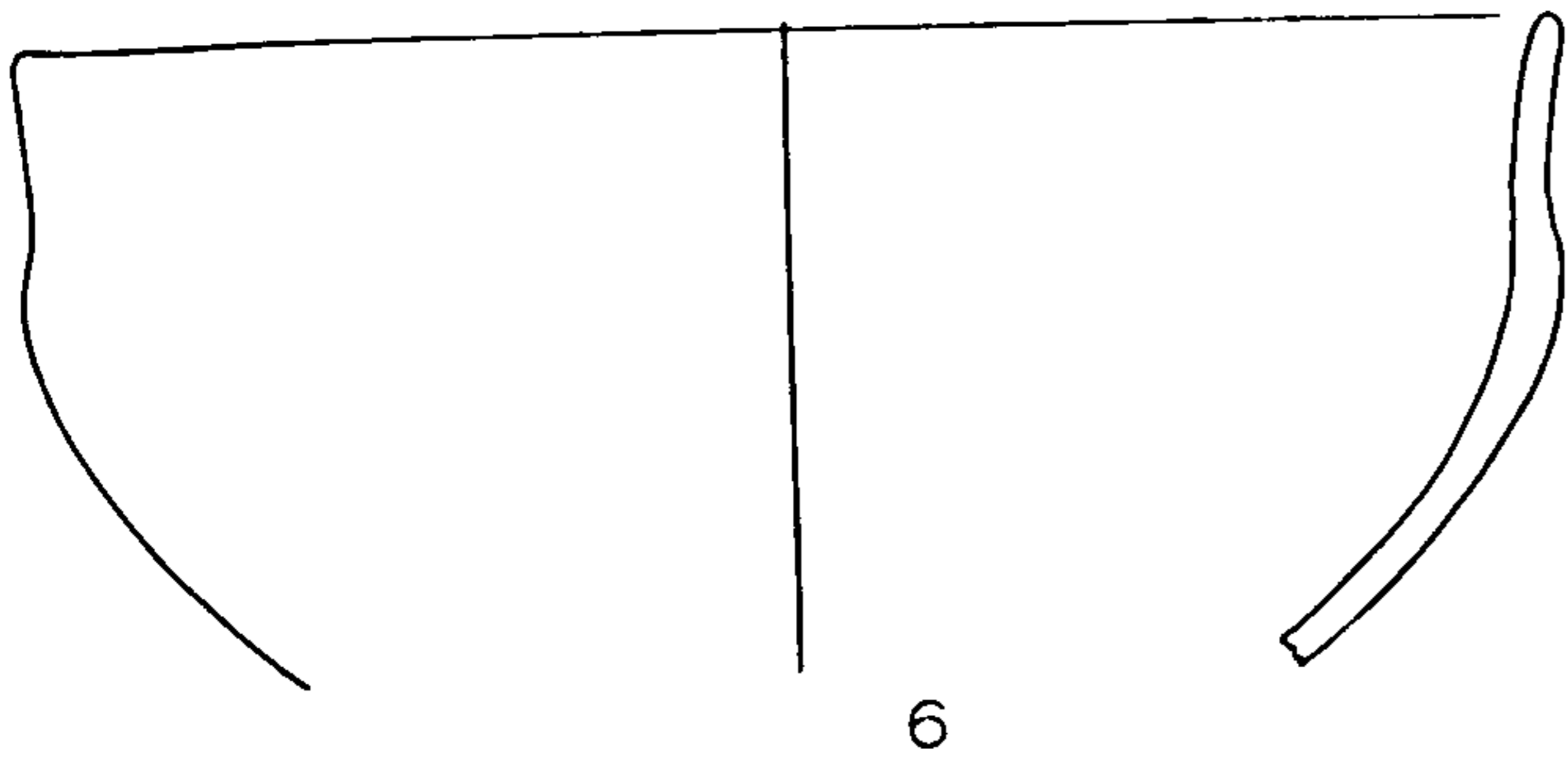
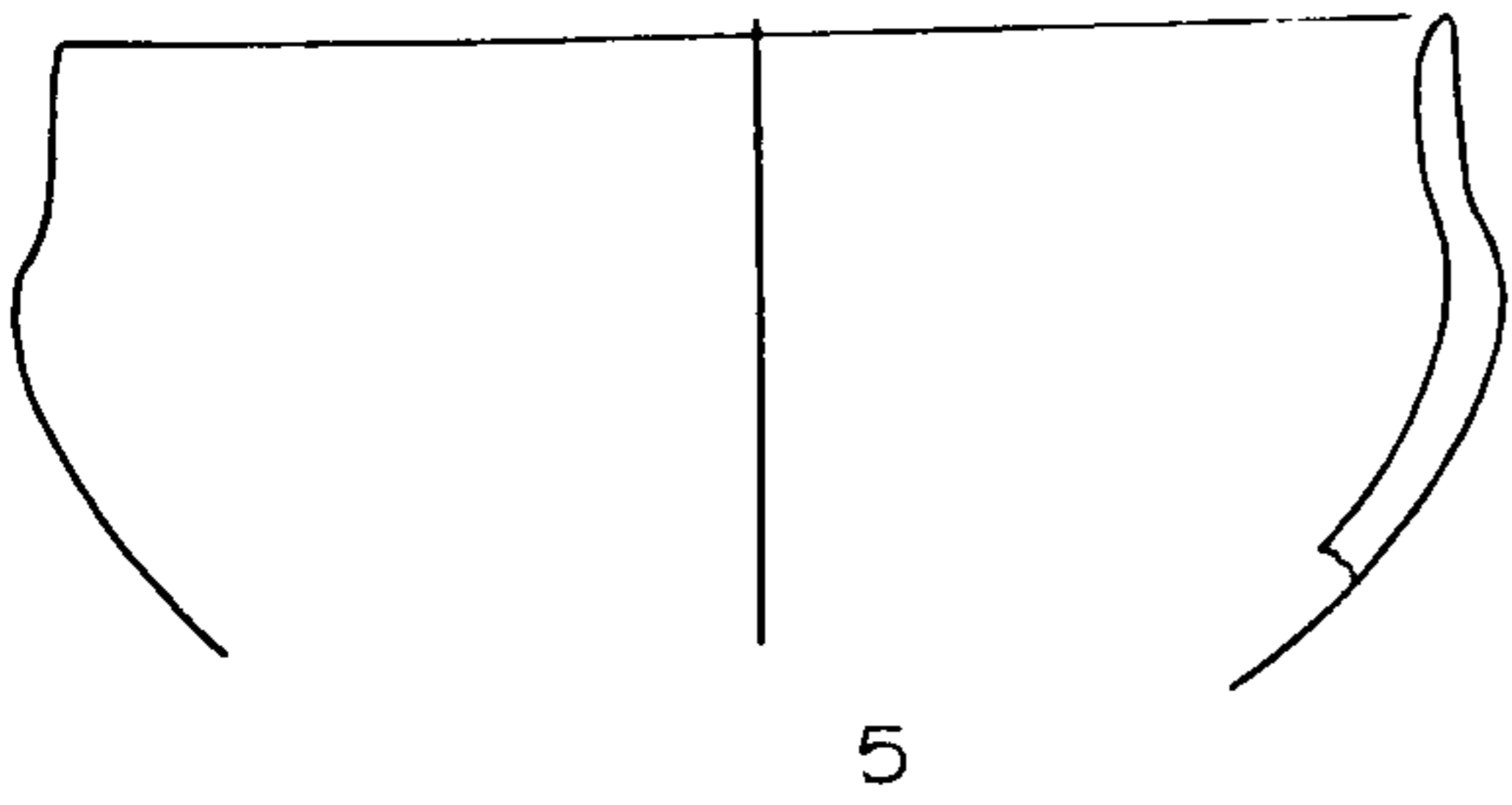
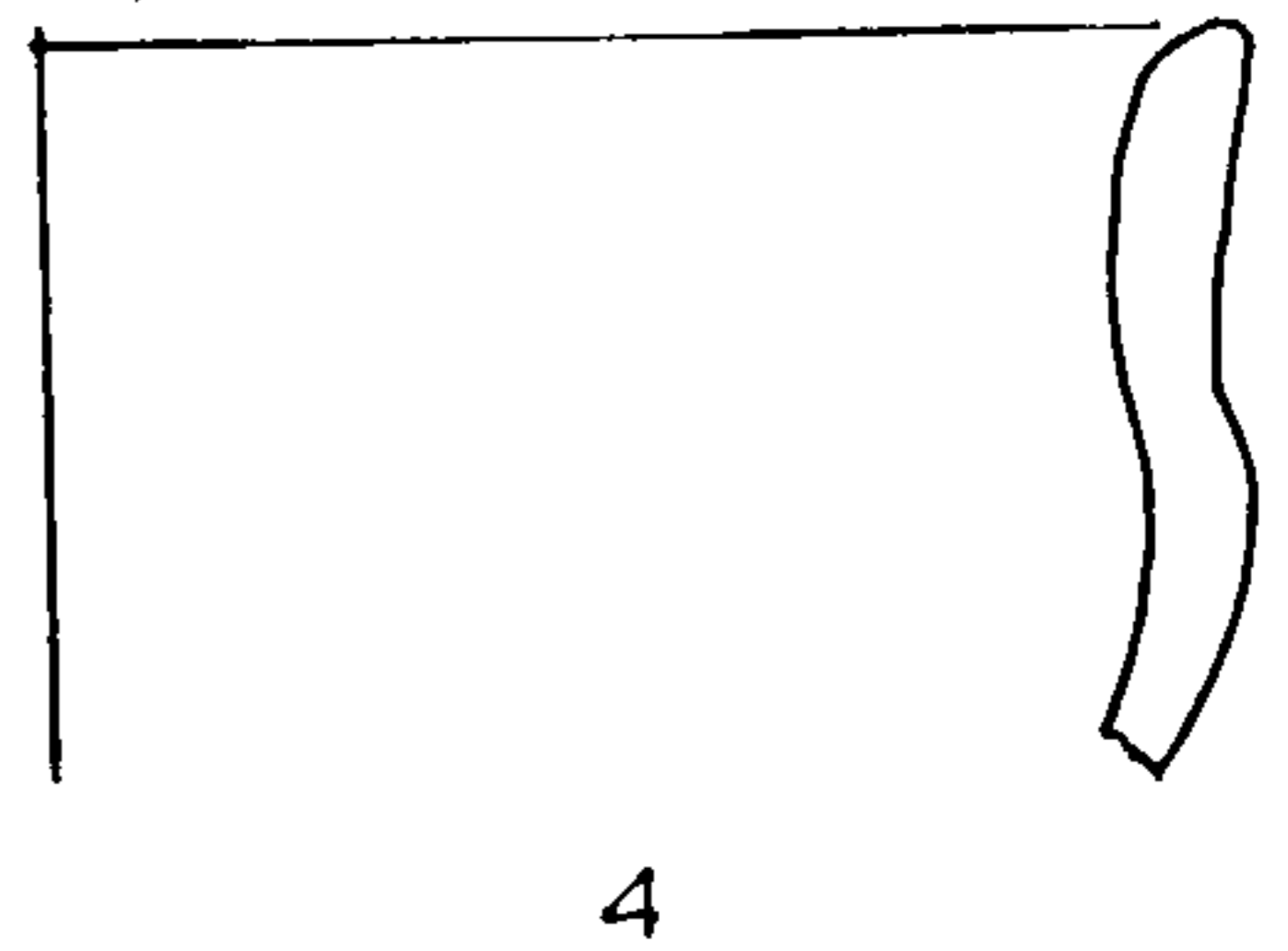
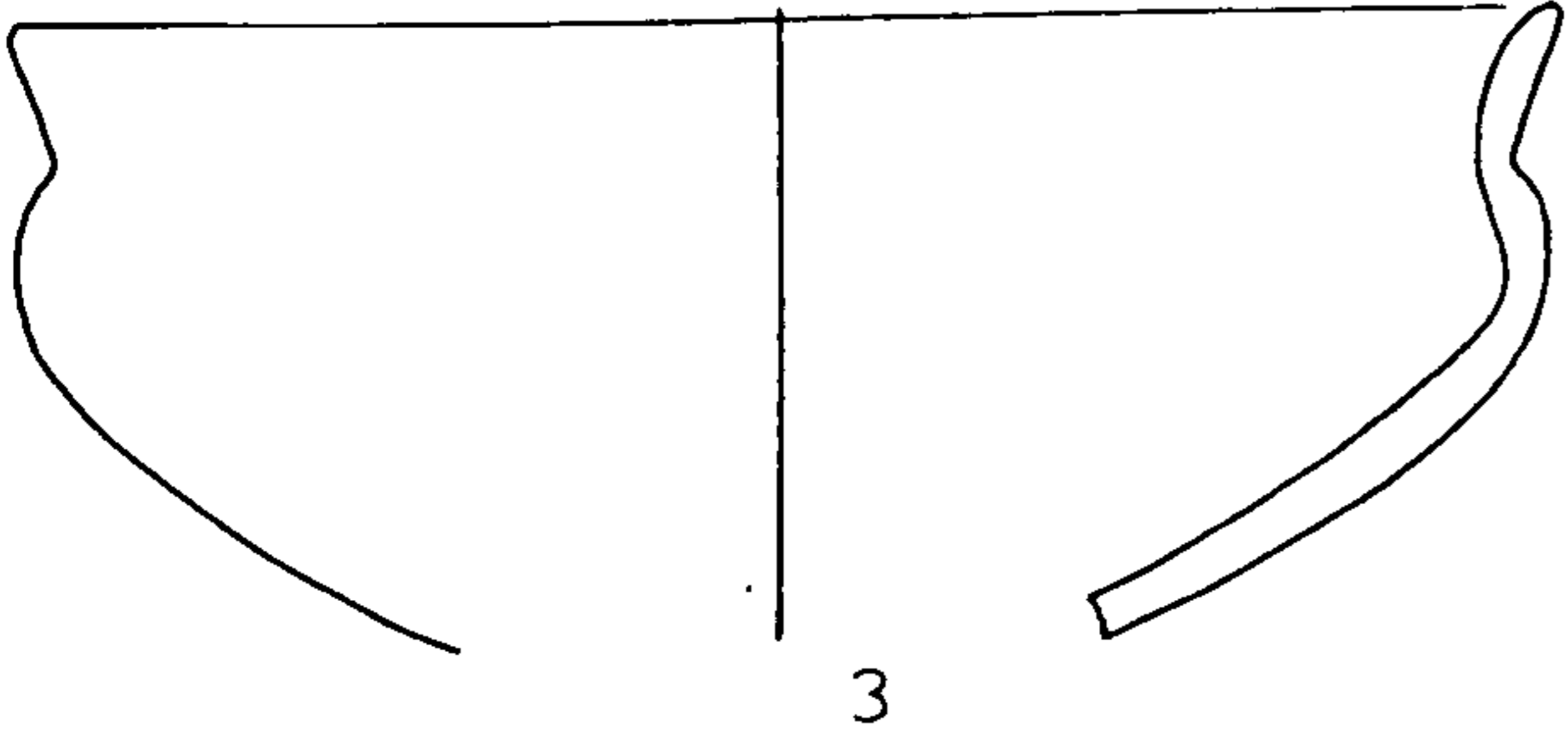
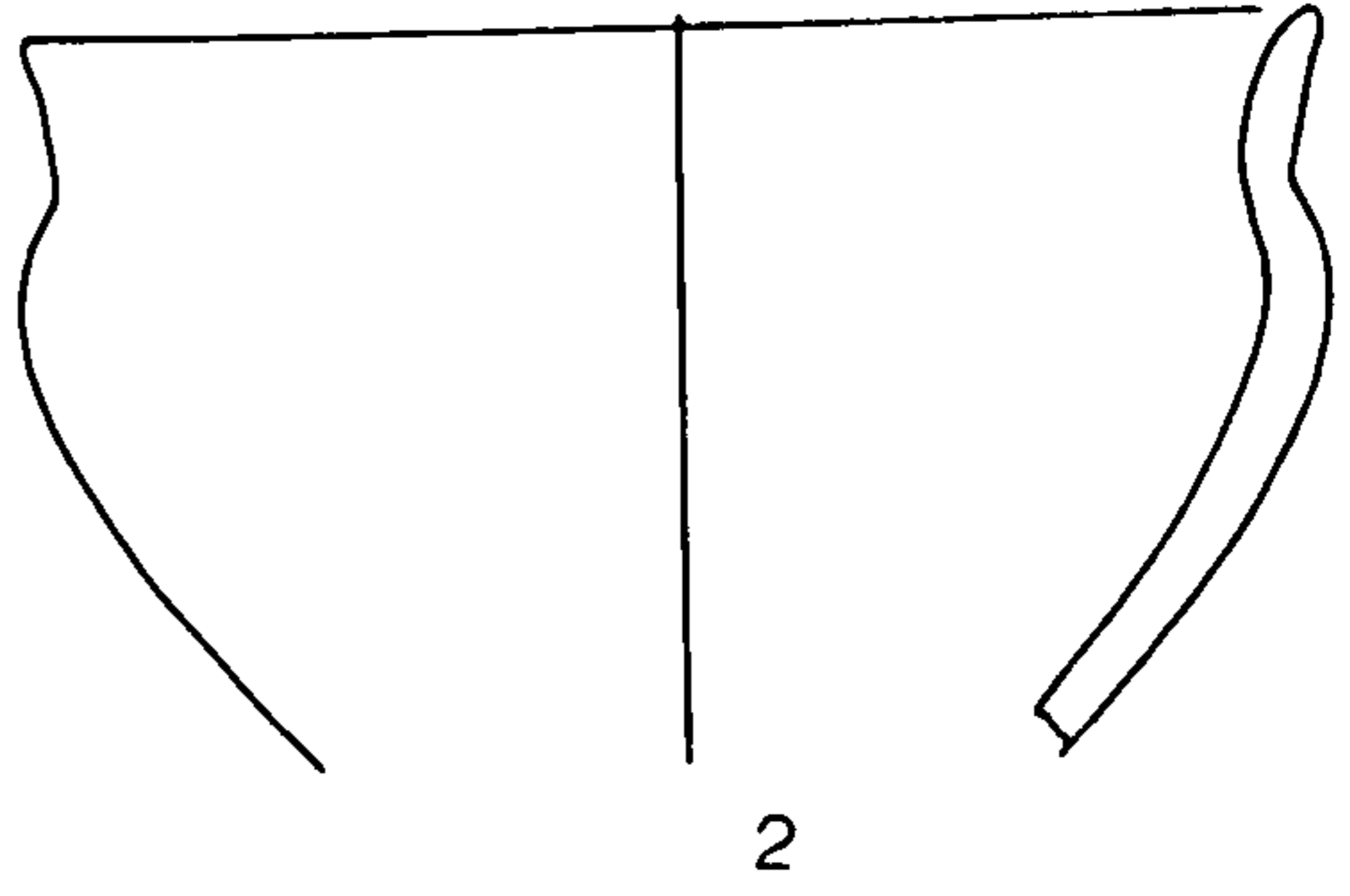
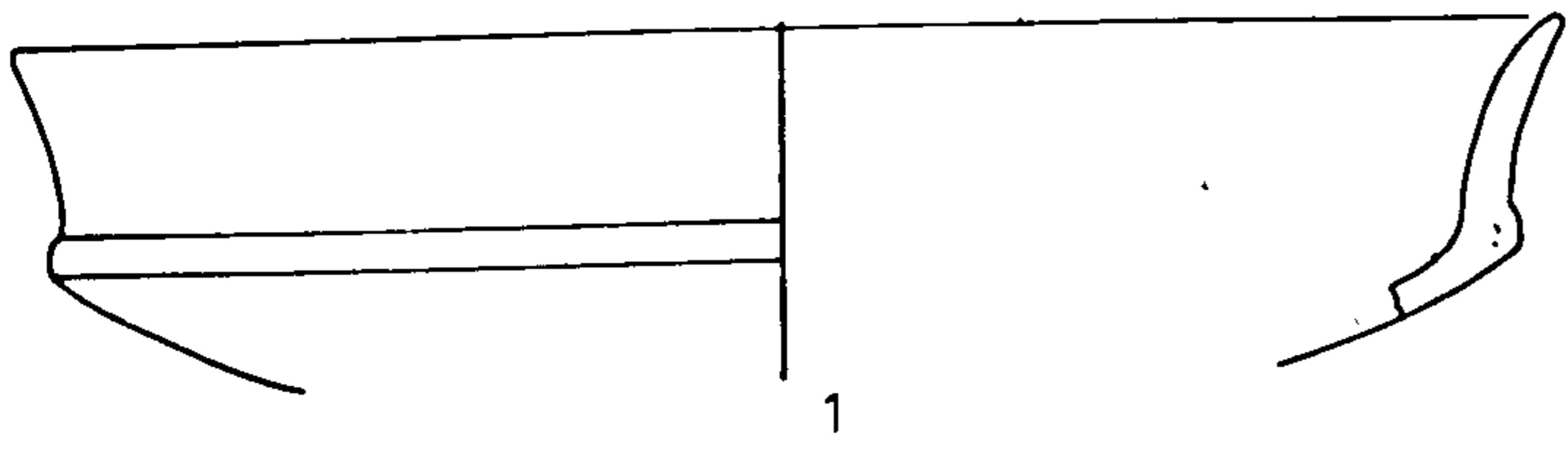

Fig 53

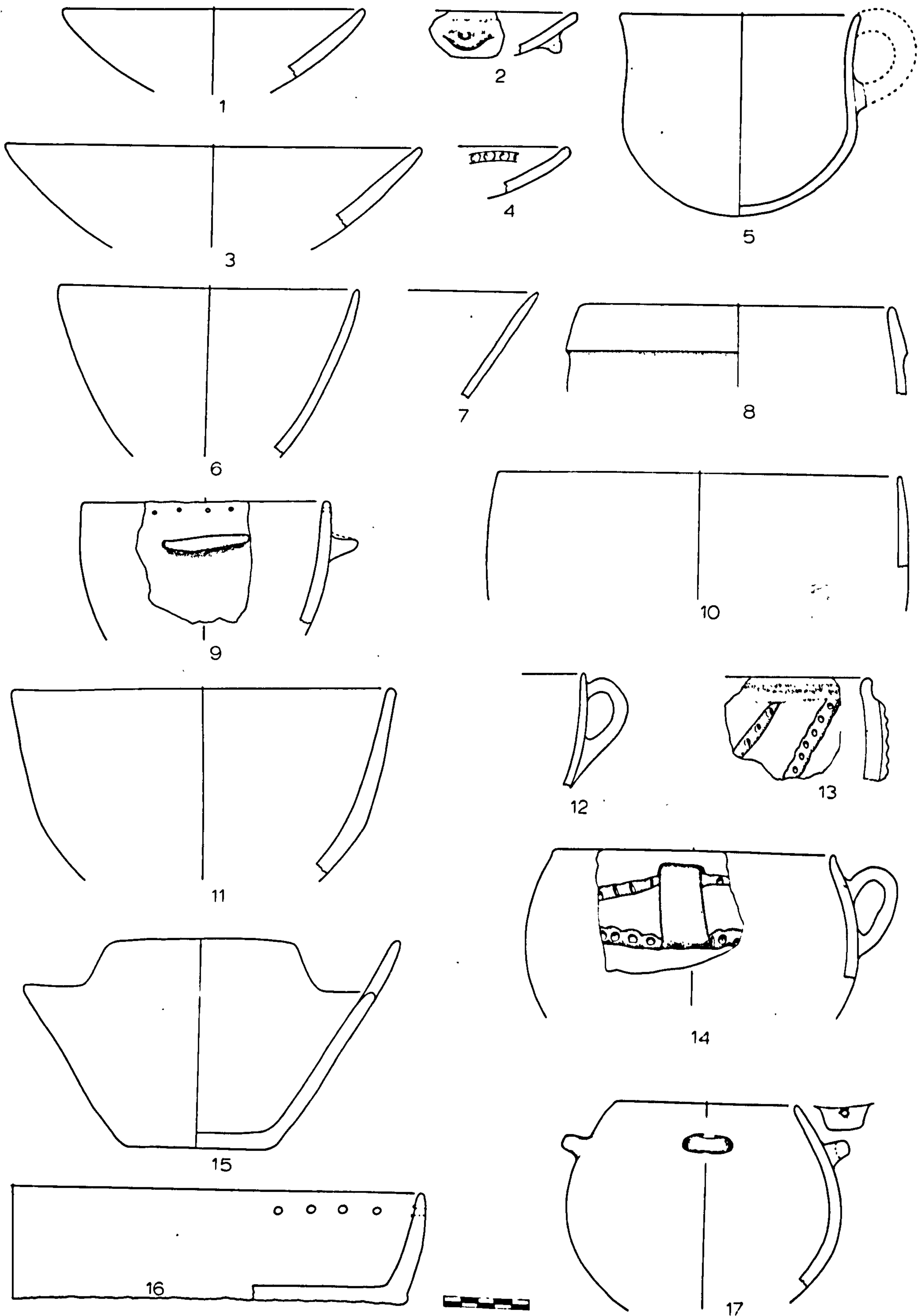

Fig 54

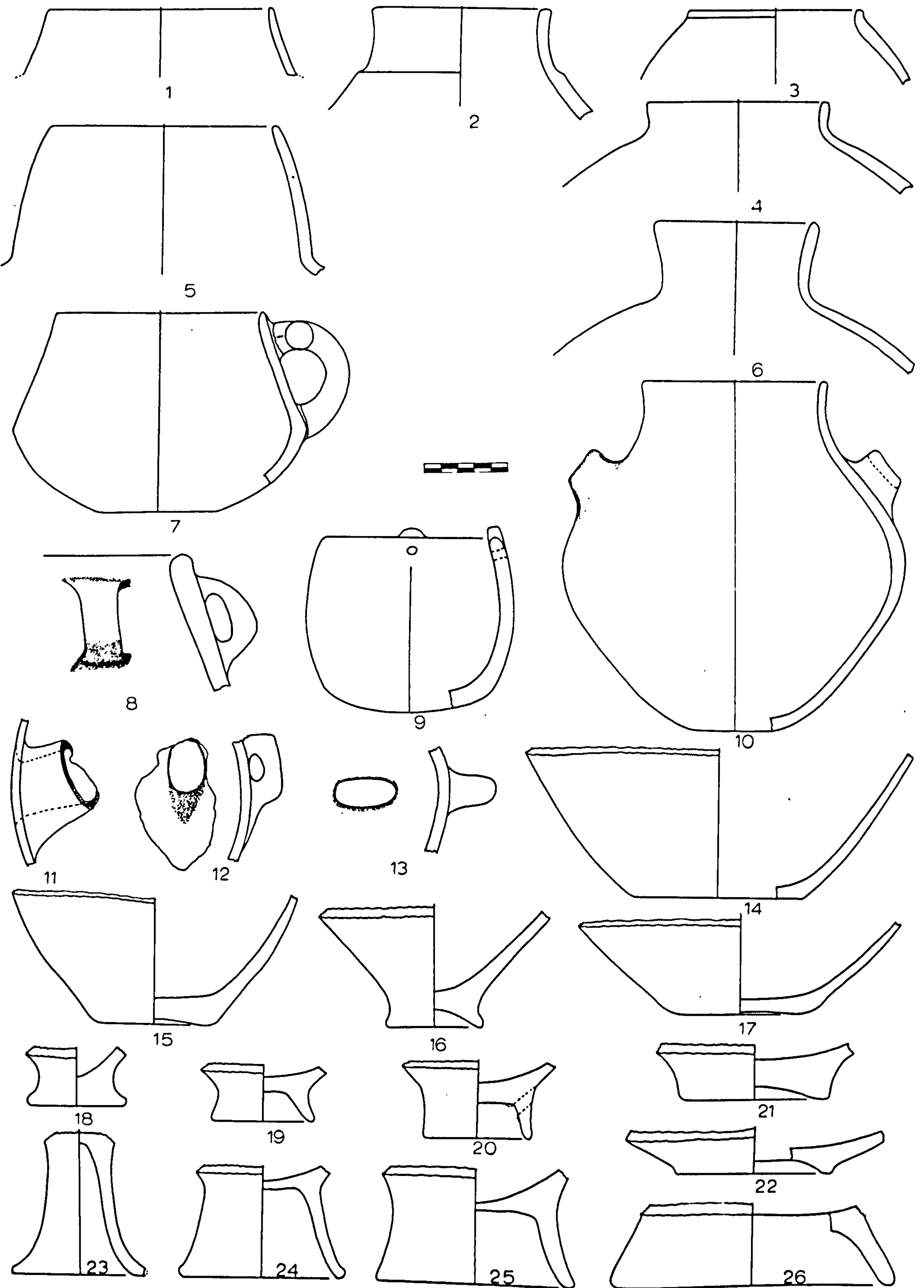

Fig 55

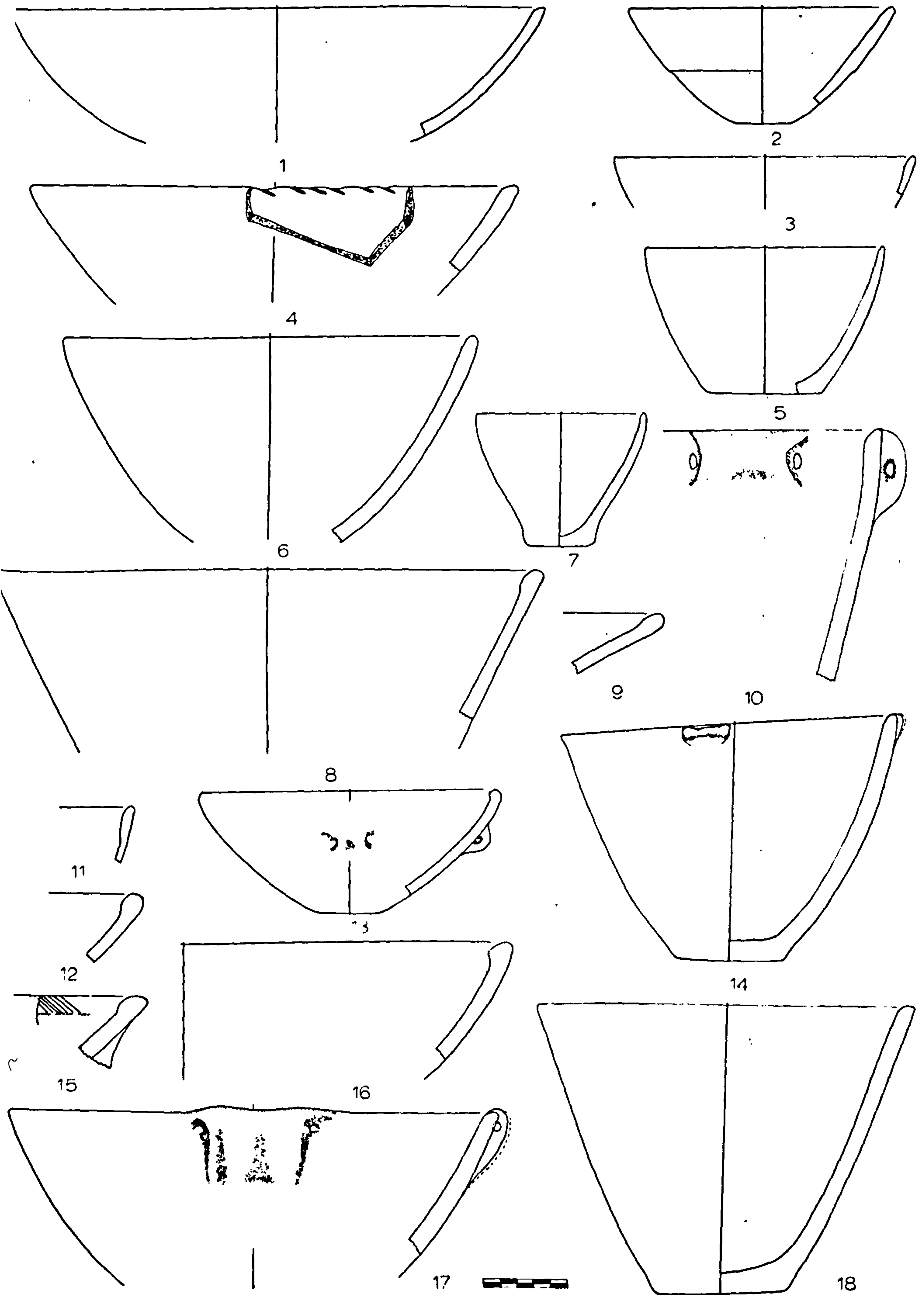

Fig 56

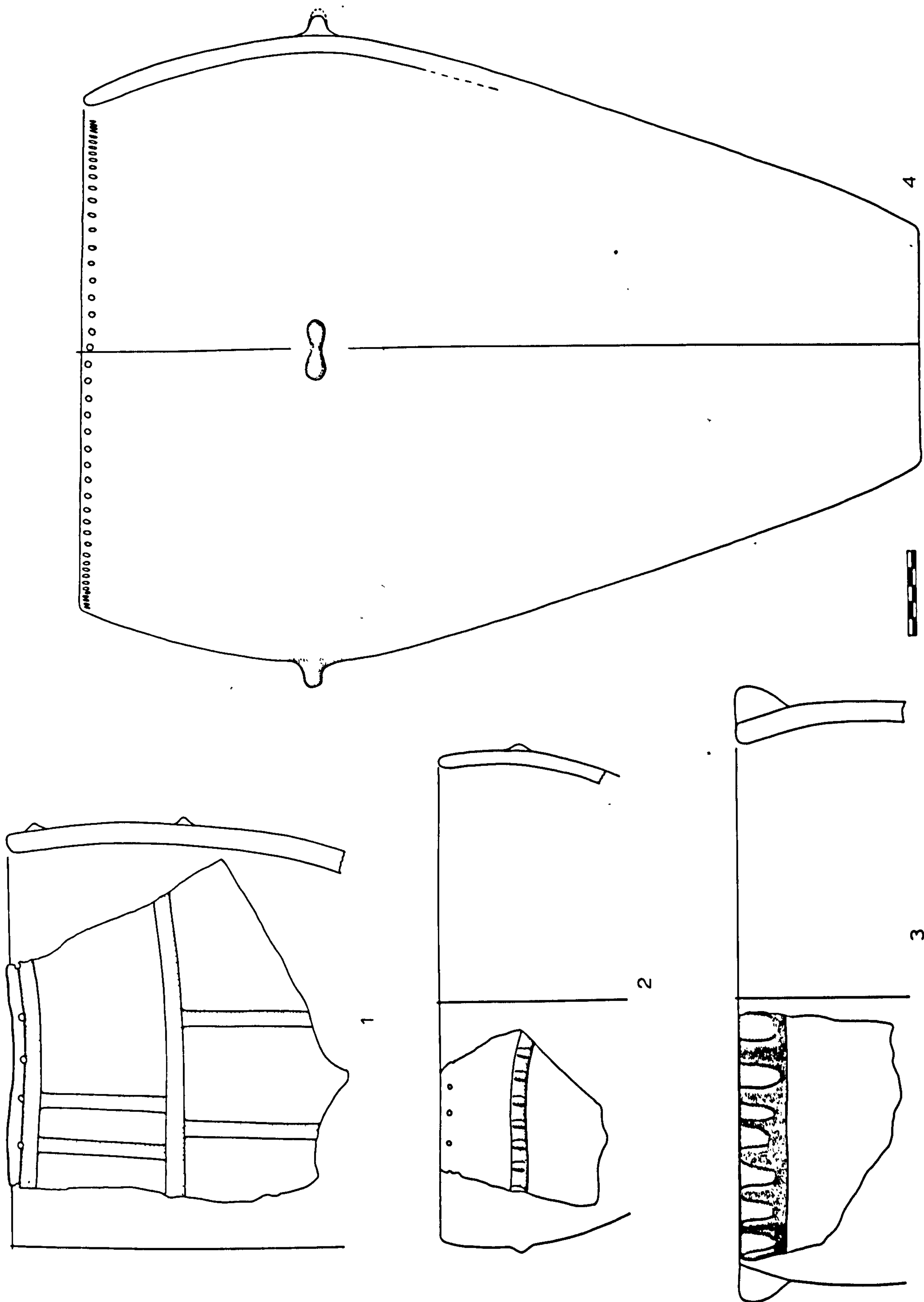

Fig 57

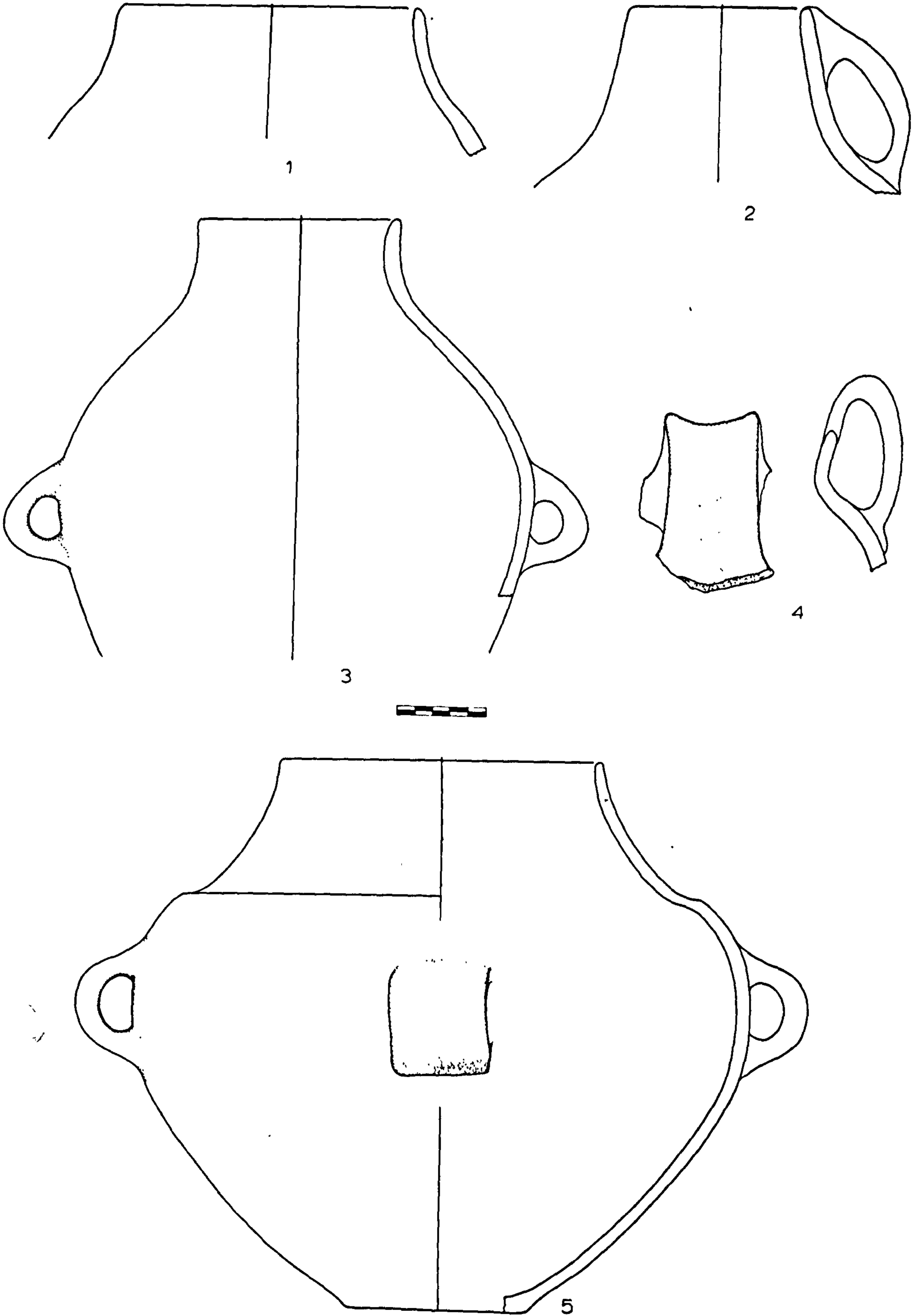

Fig 58

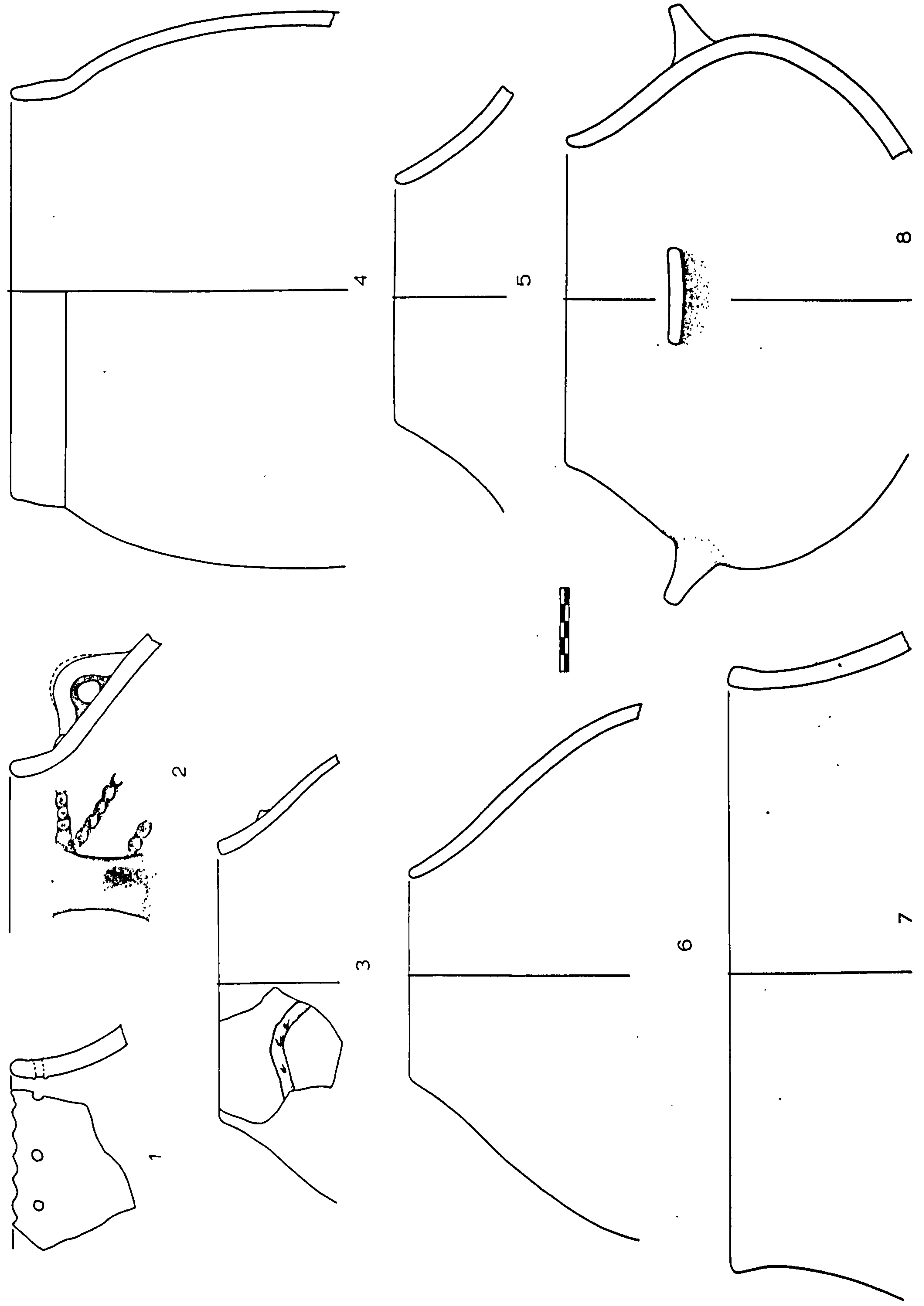

Fig 59

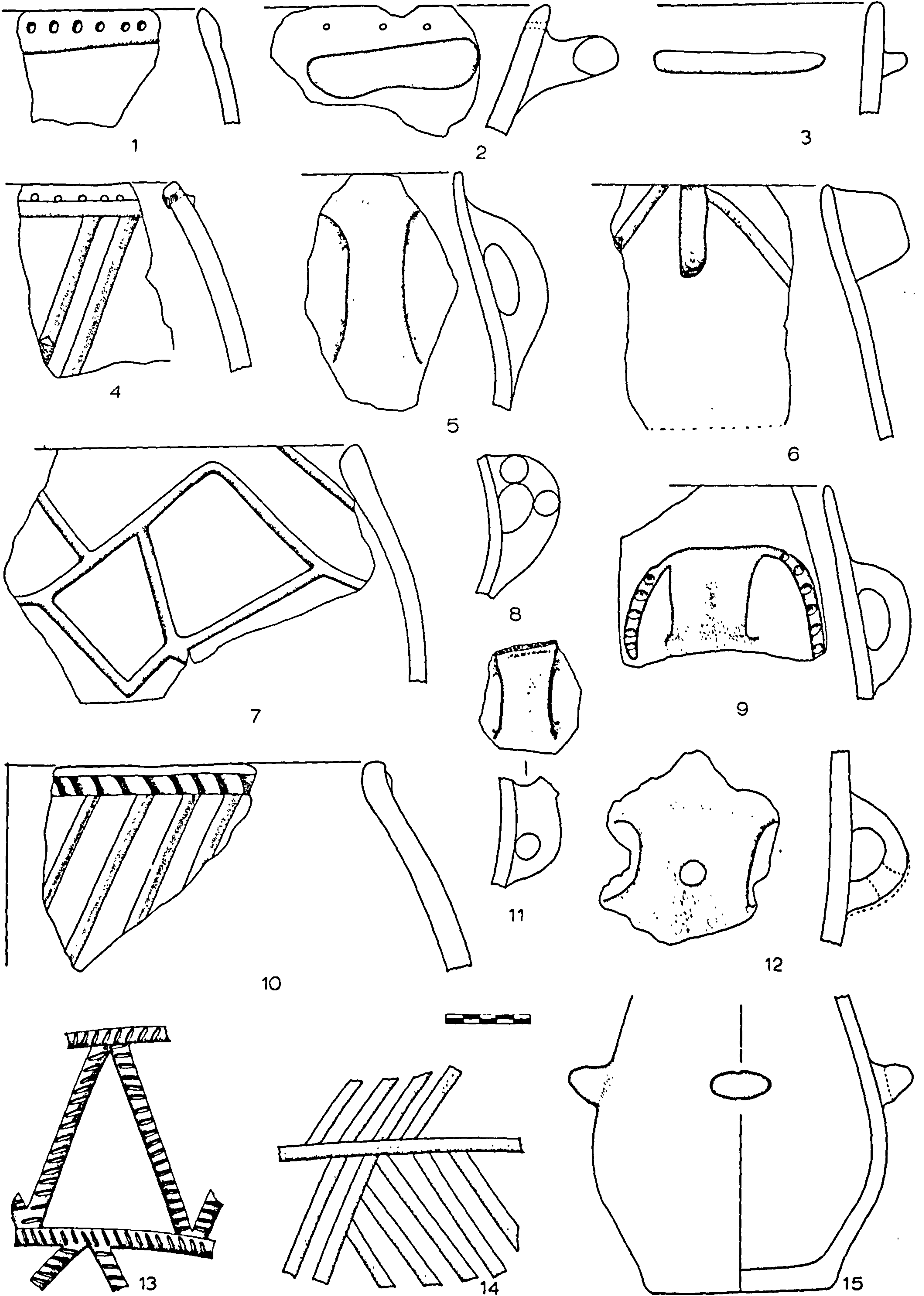

Fig 60

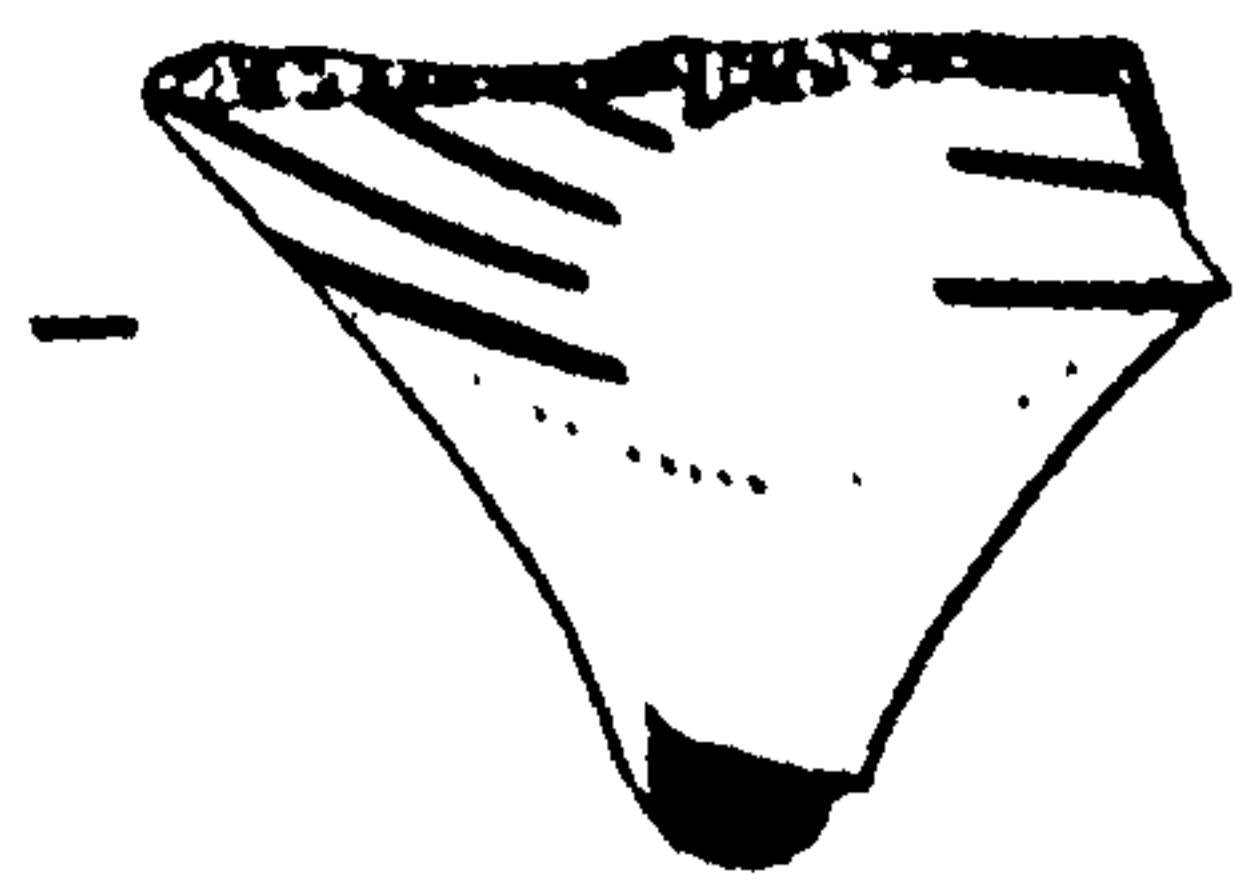
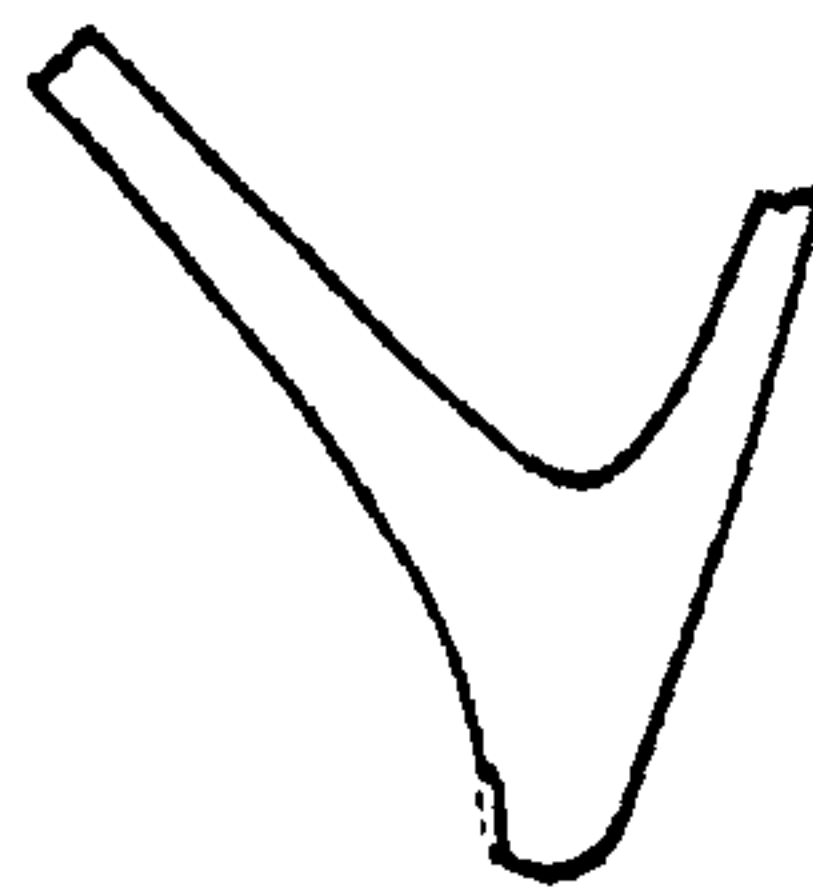
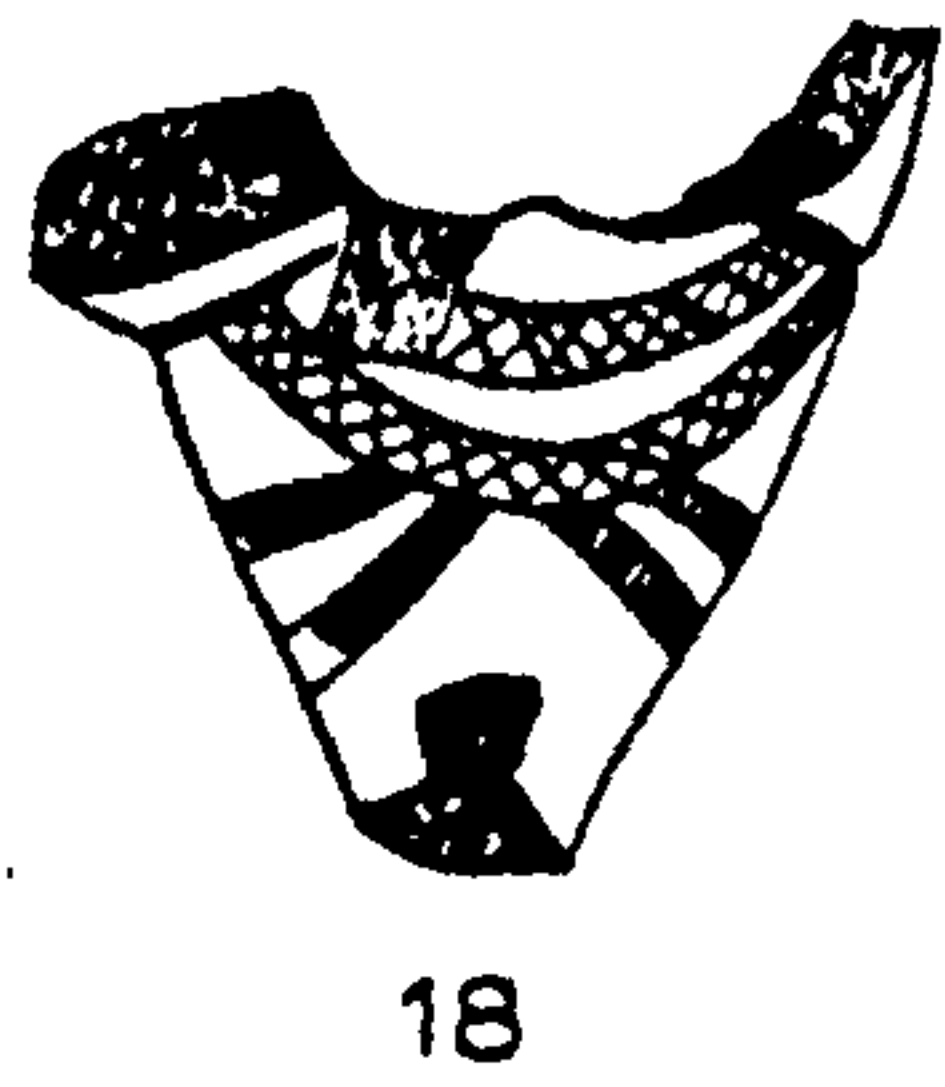
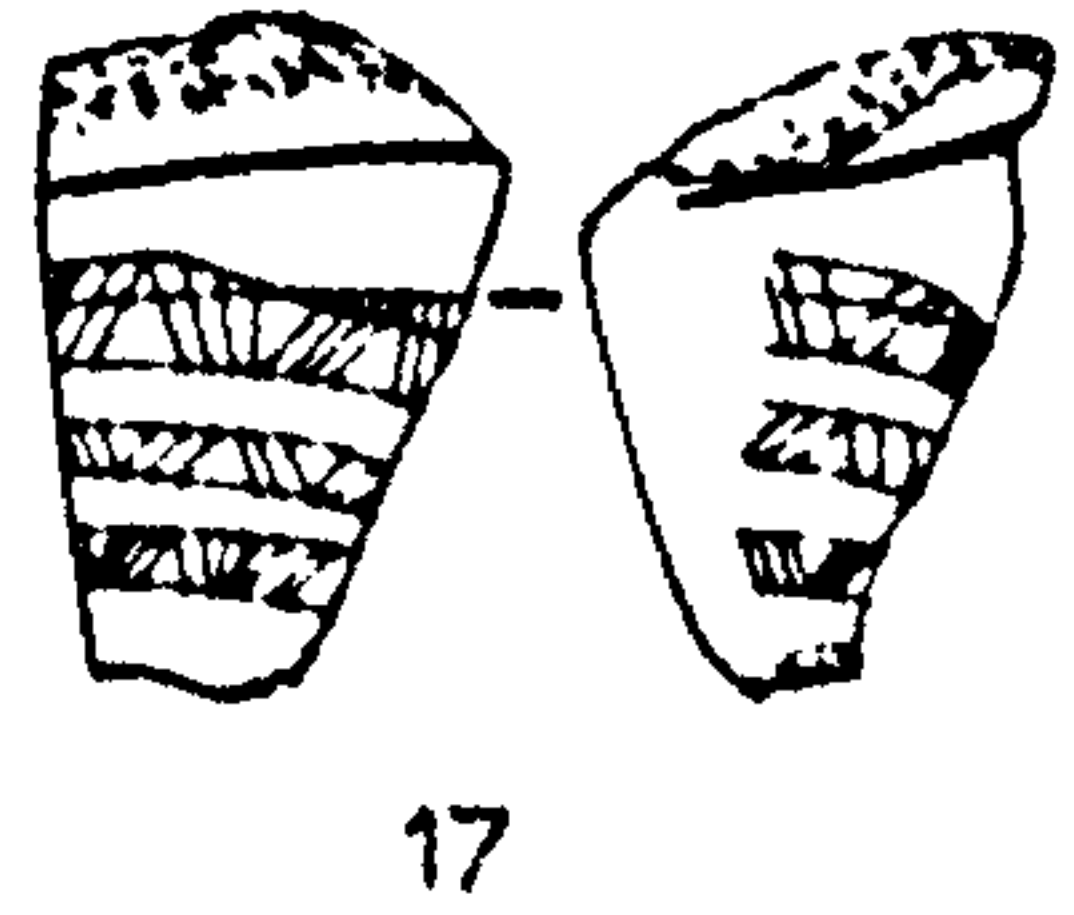
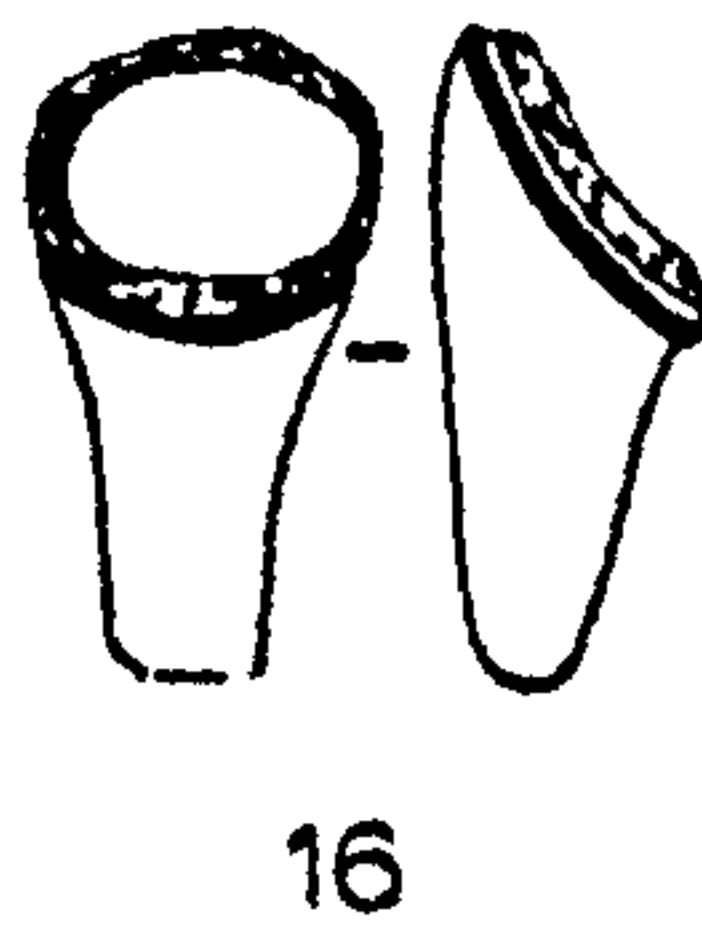
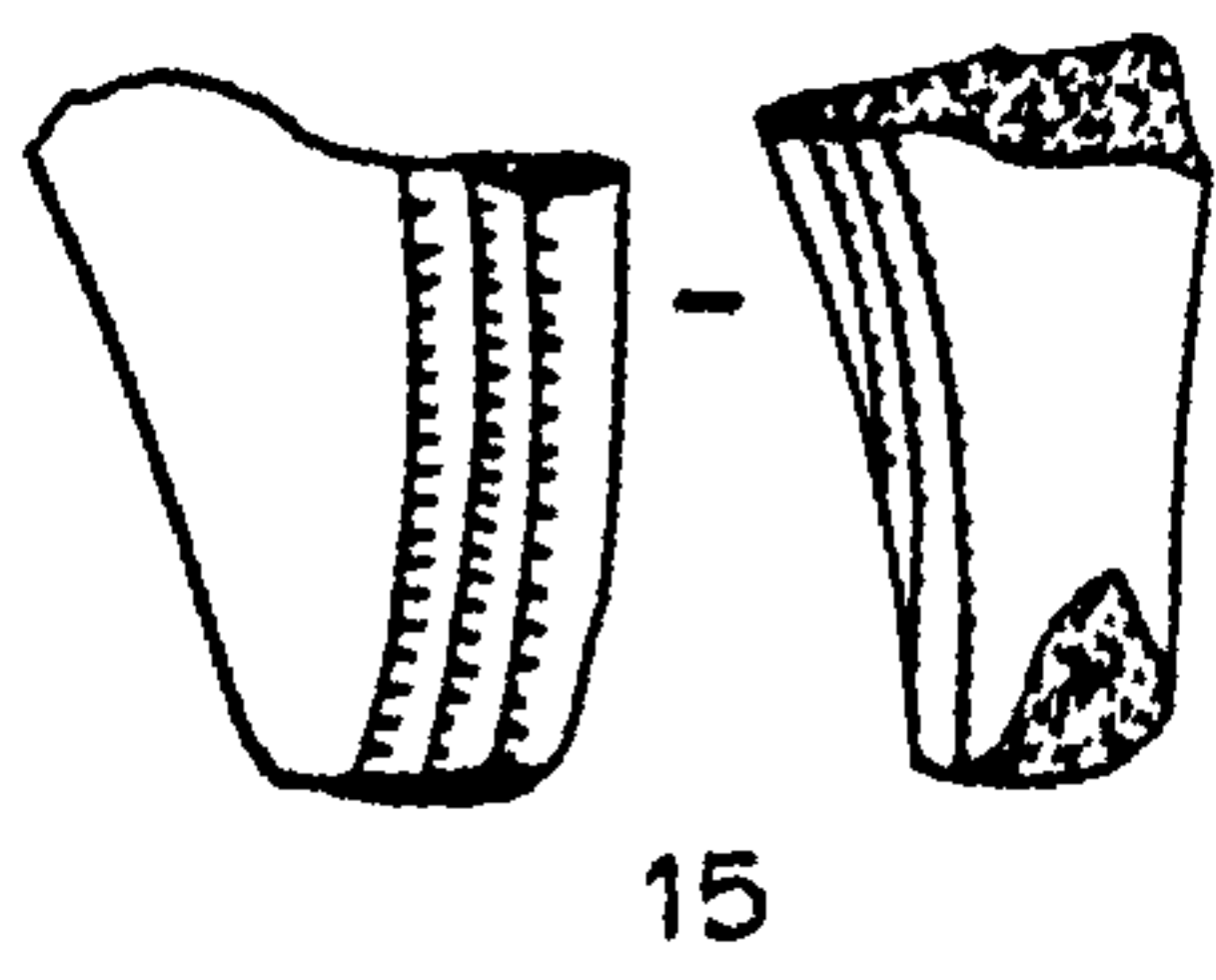
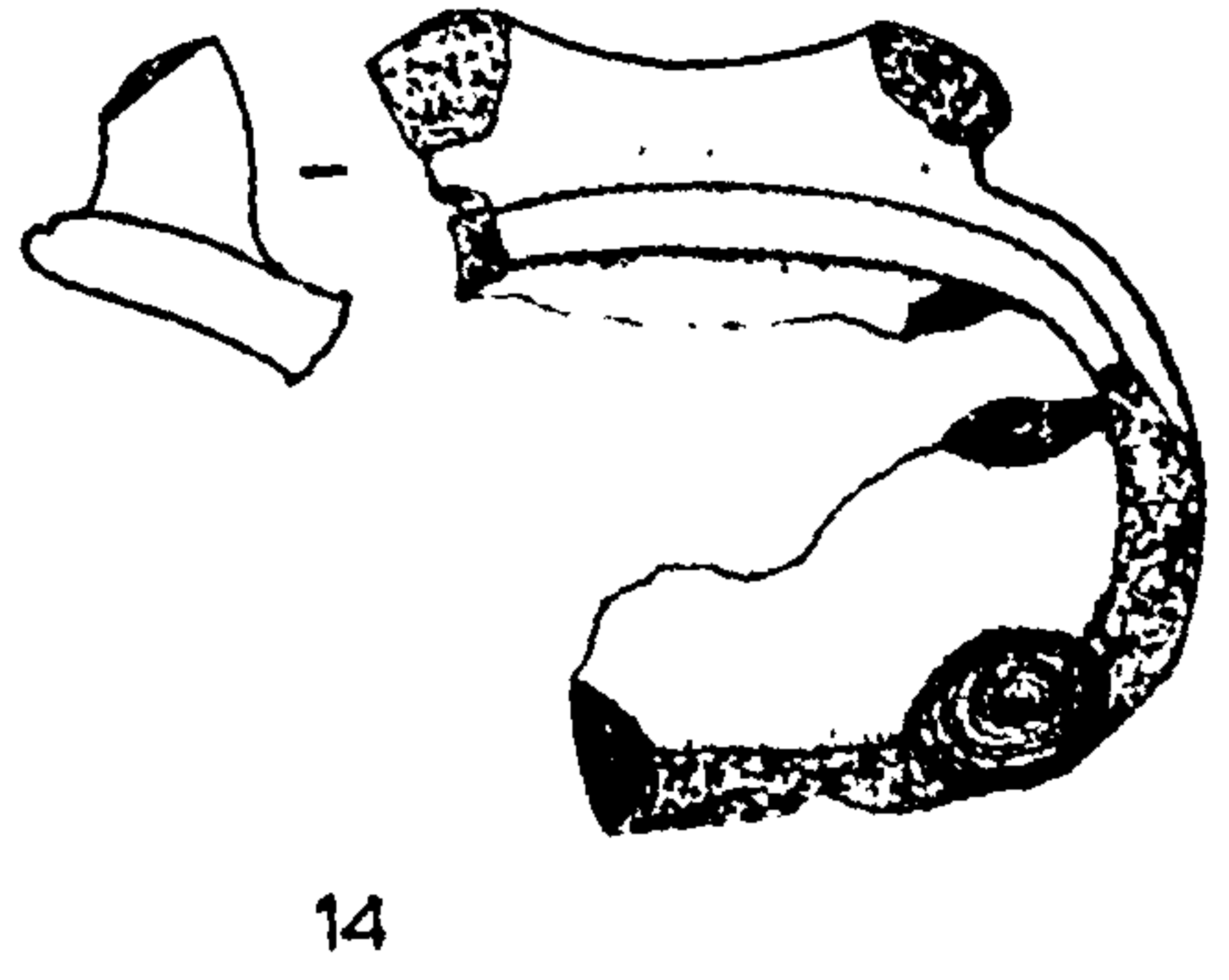
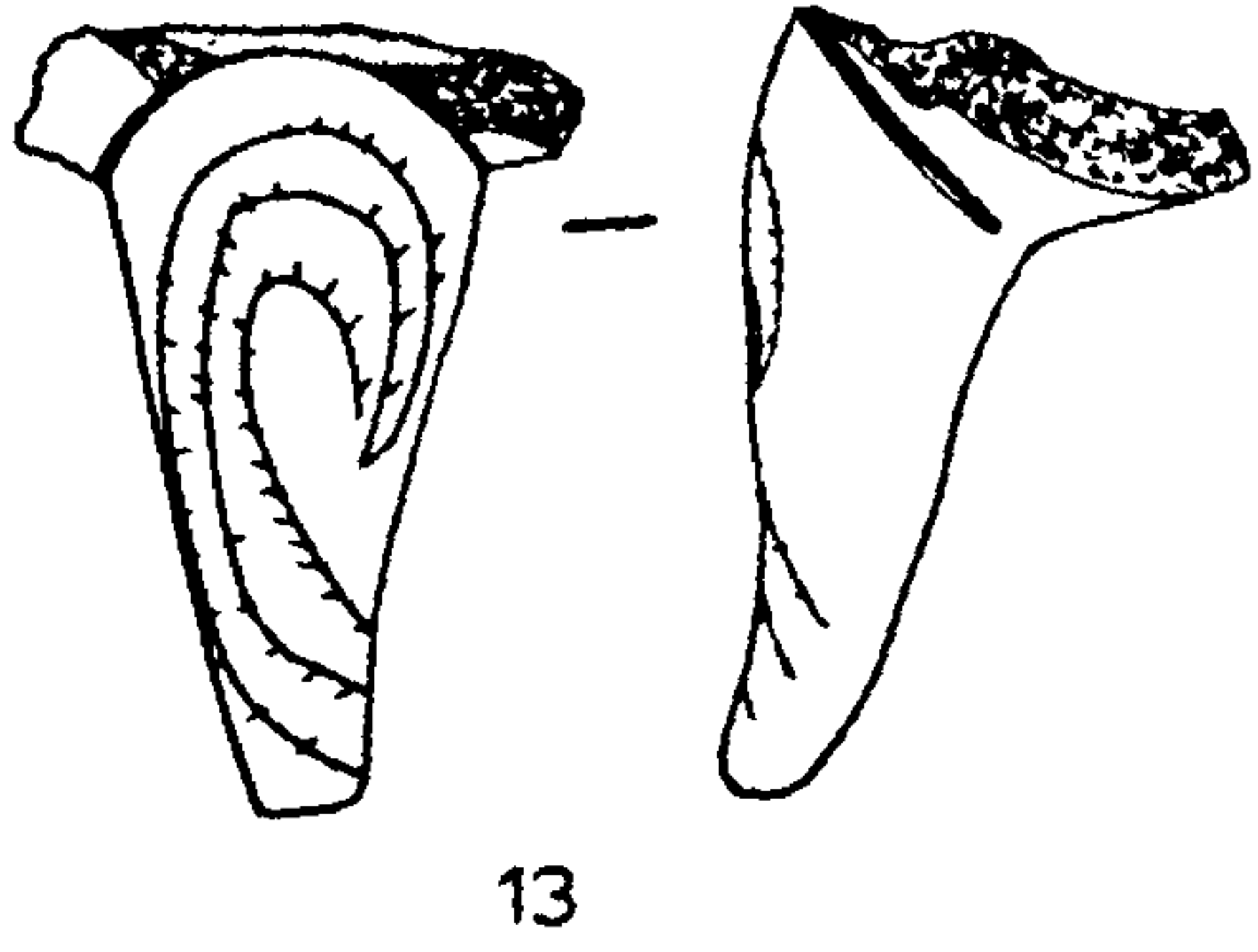
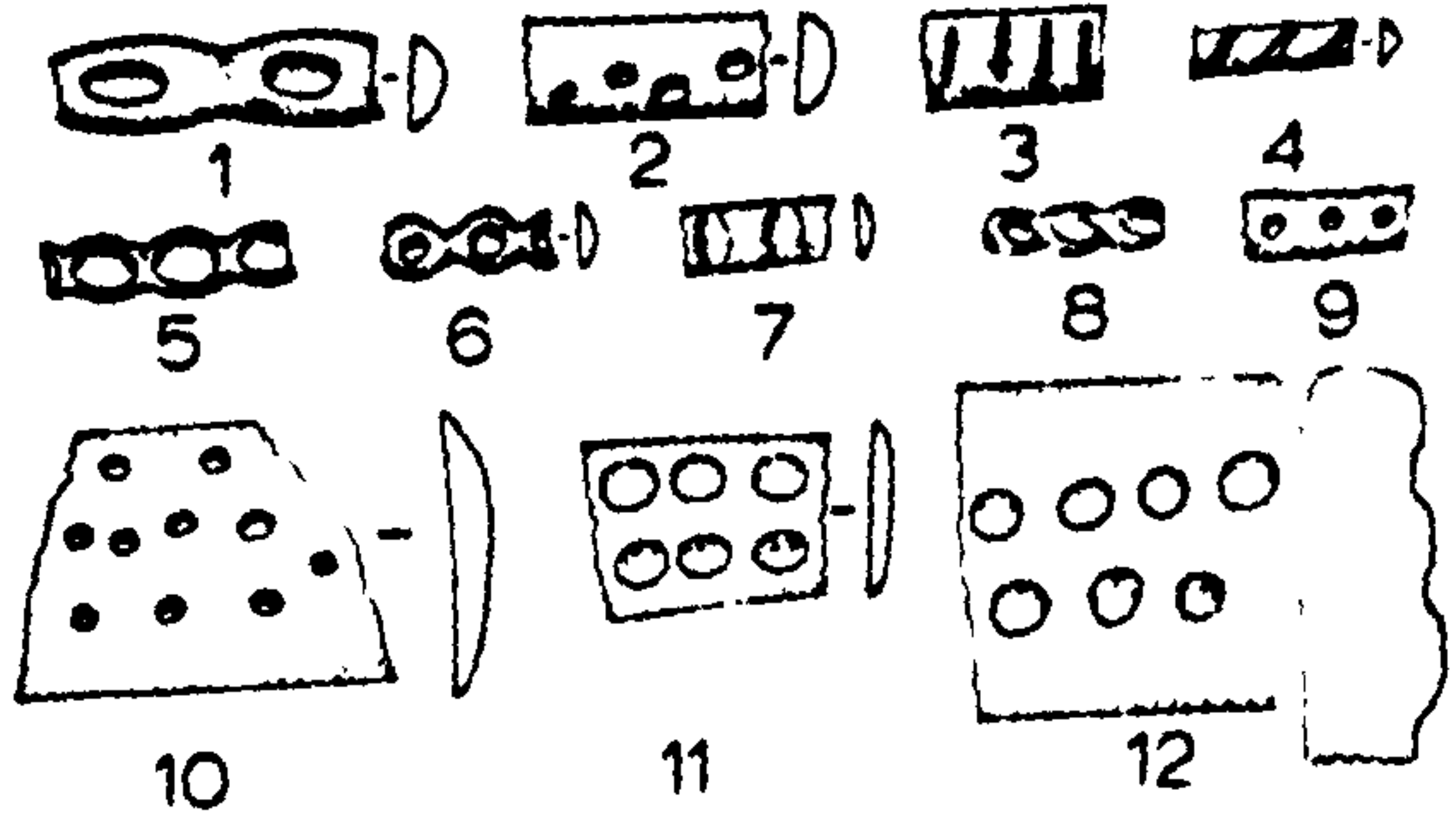

Fig 61

Map 1

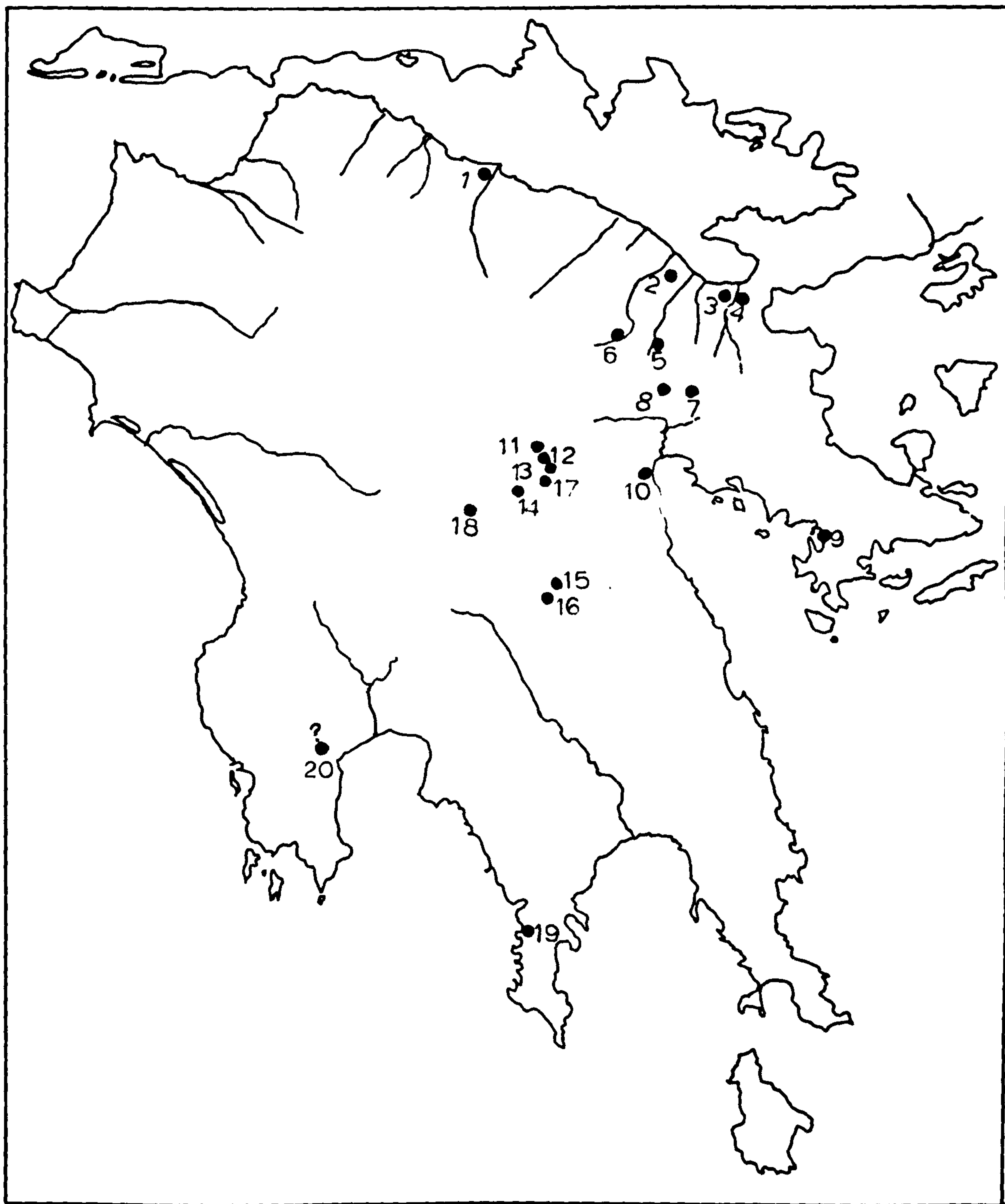

Fig. 62

Map 2

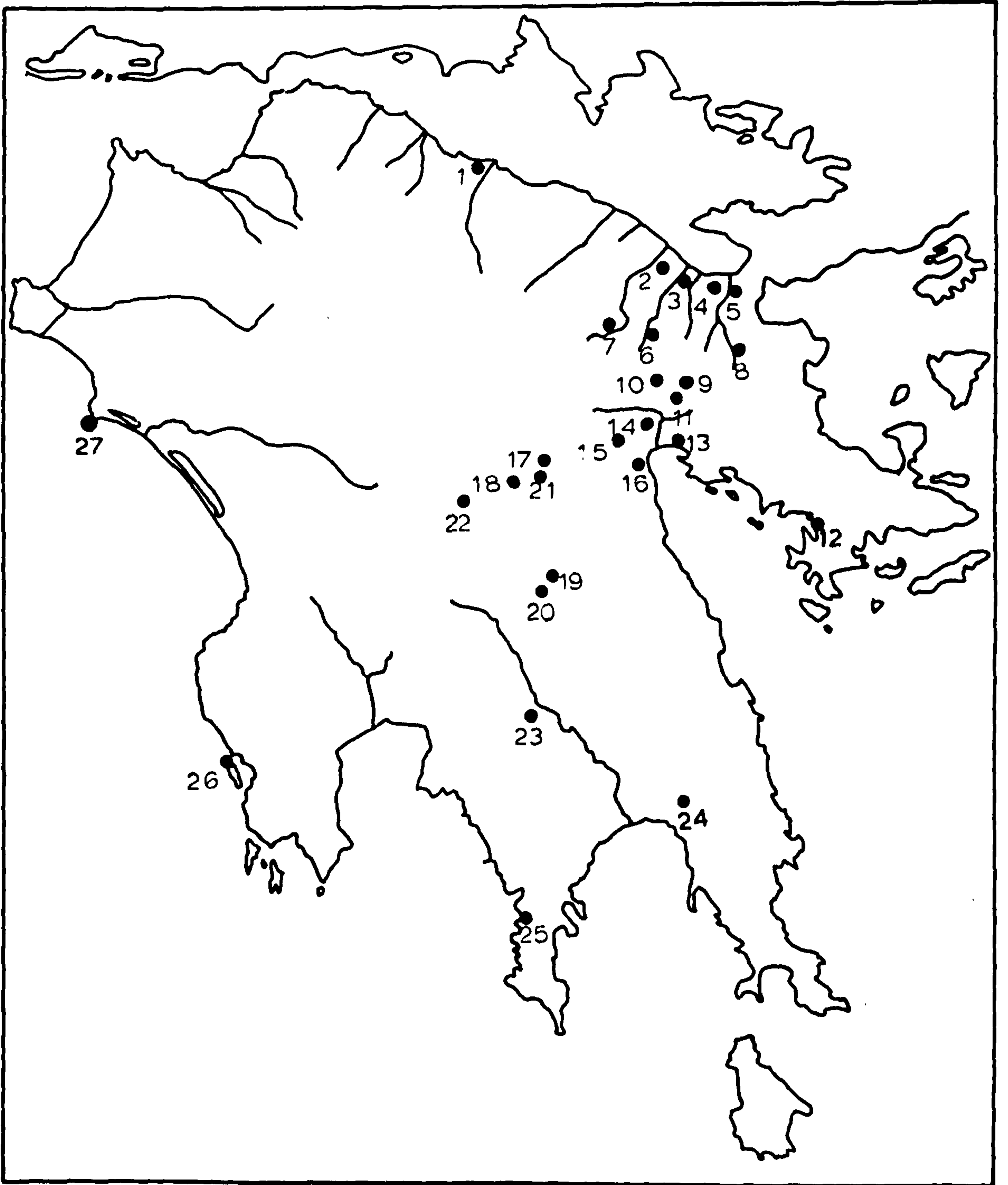

Fig. 63

Map 3

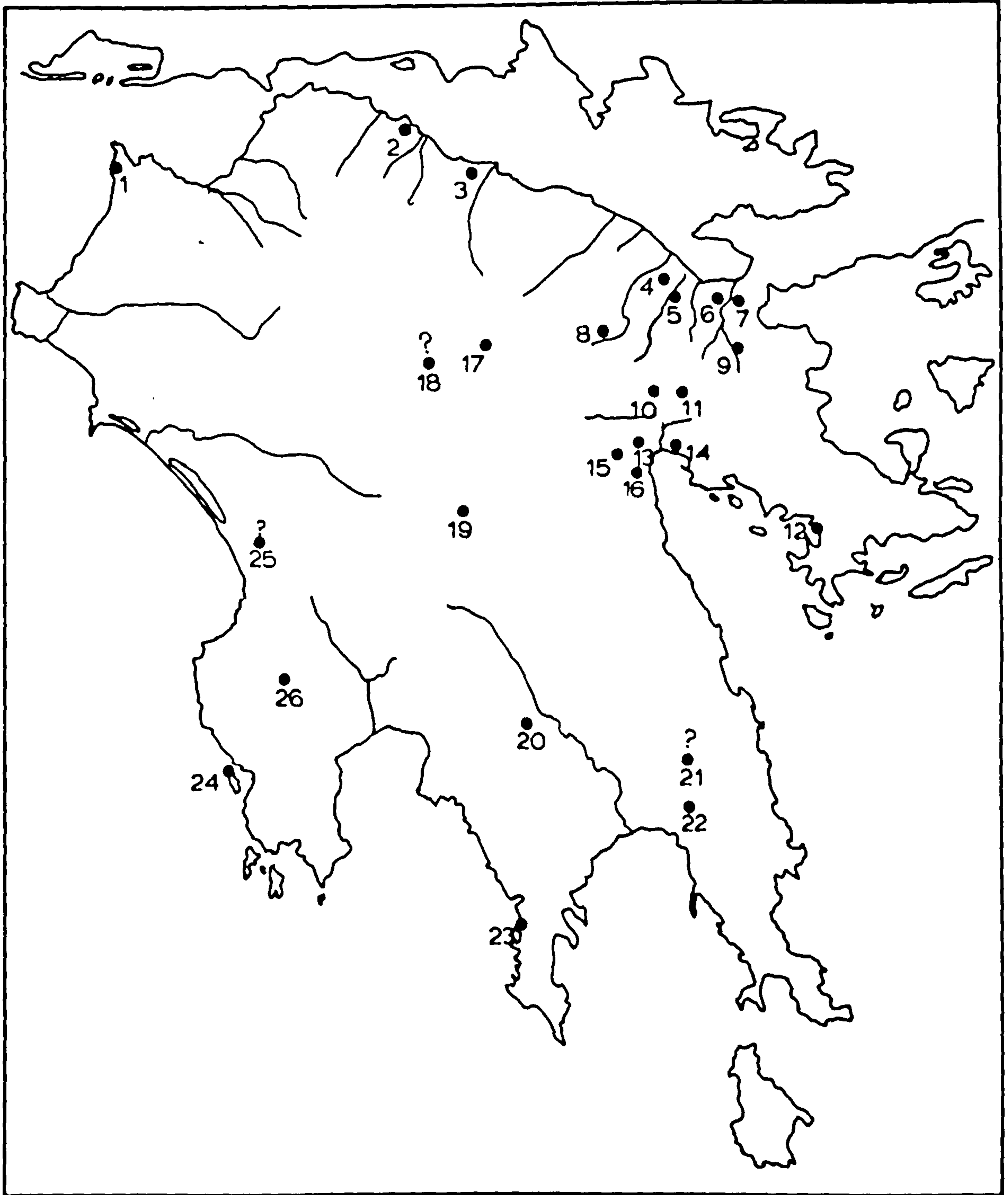

Fig. 64

Map 4

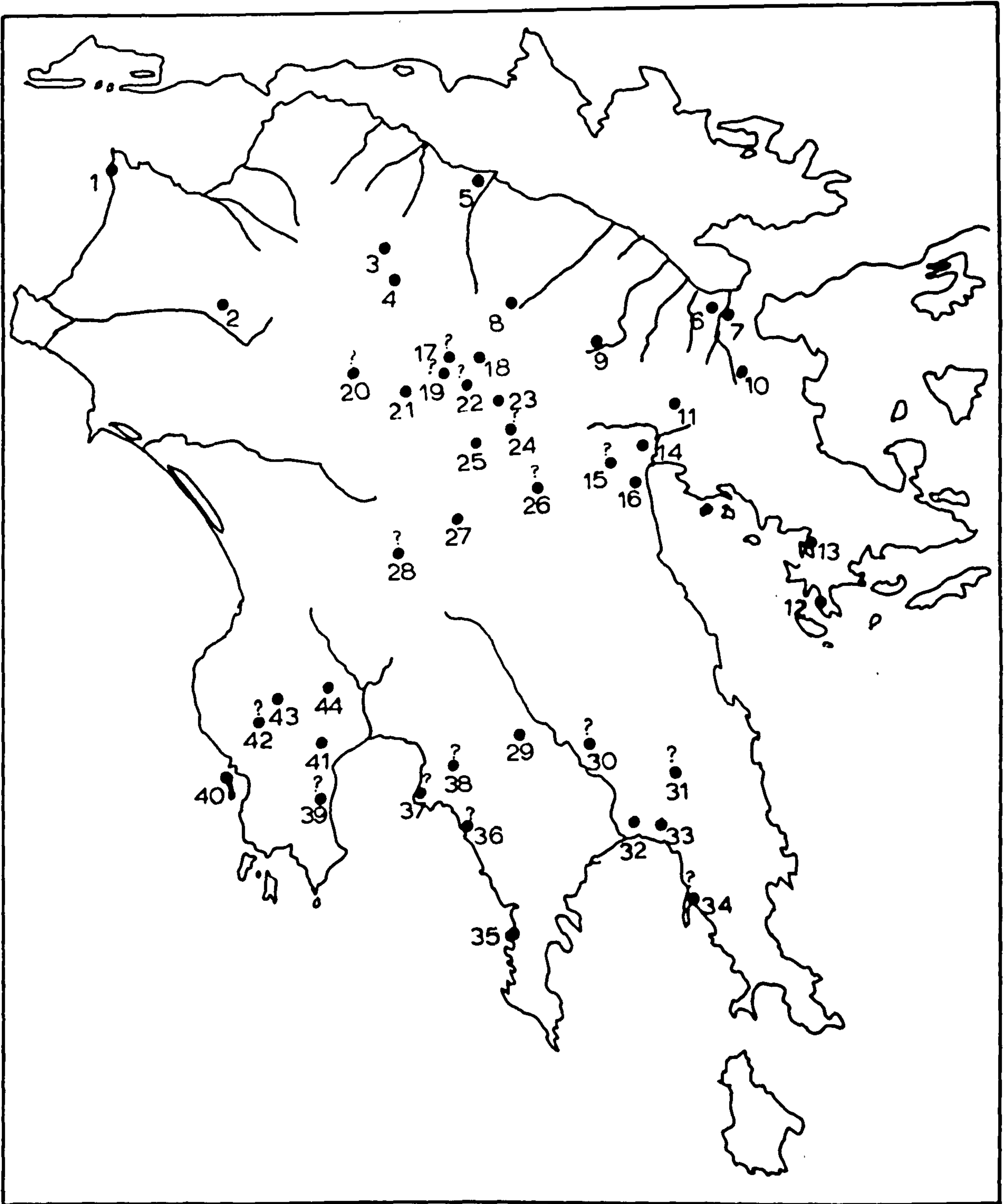

Fig. 65