

The impacts of regulations and legislation on residential built forms in Tehran

Homeira Shayesteh, Philip Steadman

The Bartlett School of Graduate Studies
University College London (UCL)

This paper addresses the challenges posed by the framing of planning law, as it affects the built forms of cities. These are challenges faced by many cities worldwide, especially those undergoing rapid change. The paper explores the role of planning controls and building regulations in shaping the built form of one of the world's fastest growing cities, Tehran. Comparisons are drawn with the historic and contemporary effects of regulations in Paris, New York and Hong Kong. There are generic implications for planning legislation in other cities. The approach taken to the research is a combination of historical investigation with some simple geometrical analysis of housing layout.

The built form and urban layout of Tehran's residential streets in particular seem to be the result of a complex process of limits imposed by planning codes and generic functions together with cultural changes and desires for modernisation. However, the influences and effects of urban parameters such as block size and proportion, as well as built form parameters such as building shape and depth are mediated by building regulations. Starting with a brief introduction to the housing sector in Iran, some primary and extremely influential housing regulations are discussed in the paper and an investigation is made to find out where they came from and the reasons behind their enforcement. The paper uncovers the role planning codes have played not only in limiting and regulating but also, as an indirect effect, encouraging and introducing new types of house. It also briefly presents the effects of regulations in other cities like New York and Paris to demonstrate that simple physical codes can have large morphological and aesthetic effects on the cityscape. It is argued that these regulations are enforced with the purpose of controlling the quality of the built environment and preventing over-crowding; however, their secondary and unintended effects on the quality of cityscape, street facade and the interior of buildings (in terms of day-lighting and ventilation) have not been considered at the appropriate scale. The paper concludes with some remarks about the importance of regulations, not only as tools to control the quality of the built environment and the overall density, but also as shaping forces in determining the built forms of cities, in their parts (buildings) and the cityscape as a whole.

Keywords:

Housing, Tehran, built form, urban form, planning, building regulations.

1. Introduction to the housing sector and decision-making process

The construction sector, including house construction, is one of the most central economic sectors in Iran with a huge share of total annual investment. Due to its potential for growth and its capacity to generate both employment and income, it has a significant place in the economy. According to information from the World Bank report no. 28983

(May 2004), Tehran has the highest share in the world of private sector investments in urban housing (56.2 percent). The building pattern of house types is shifting in Iran. For a long time, one-storey masonry courtyard houses have been widespread in the country. In Tehran specifically, this pattern has been rapidly changing in favour of multi-storey steel or concrete structures. The development of a grid network of roads through the centre of the old

Figure 1:

Redevelopment not happening simultaneously leaves the skyline of Tehran's streets fragmented - example of a street in Borough 2.



city caused a rapid transformation in residential streets and housing layout. In addition to the need for vehicular access to the streets, modern techniques of construction also had a huge influence on the residential built form of Tehran. The lack of an overall plan for street facades, the absence of coordinated developments in the demolition of single or multiple family terraced houses and the redevelopment of terraced apartments have left many residential streets in Tehran with very chaotic skylines (Shayesteh, 2013).

In 1977 the Ministry of Housing and Urban Development was ordered by the Law for Reforms in Architecture and Building Systems (1977) to develop the *Iranian National Building Code*, although the serious development of a comprehensive code began ten years later. Despite the majority of the housing stock being masonry, the Building Regulations in Iran indirectly support steel and concrete structures to withstand earthquakes. The decision-making process in urban and housing development in Iran is very centralised in that general policy-making, monitoring and planning at national, local and city levels are the responsibility of the Ministry of Housing and Urban Development. The municipalities, however, are obliged to comply with the decisions and have less power (Chatterton et.al, *World Bank*

Report, 2004). There is a very complicated procedure for issuing building permits according to the Building Regulations. In Tehran, submission of two sets of drawings is needed in order to acquire planning permission. A registered architect must sign the architectural drawings and a registered civil engineer is required to sign the structural drawings and calculation sheets:

'There are fixed limits on the number and size of projects for professionals according to their ranking and experience. In Tehran, the owner is also required to hire a third engineer or architect to supervise construction. Regulations are more rigid in Tehran in comparison to some smaller cities and many of the regulations are not practised in the same detail in smaller cities. For example, no distinctions between civil engineers and architects are made for signing architectural drawings and structural calculations. In many small cities, no drawings are submitted at all' (*ibid.*, p.134).

The regulations and the process for obtaining planning permission explained above are set to control housing production; however, they often have contradictory objectives. The Ministry clearly recommends revising the municipalities' regulations for issuing building permits to encourage multiple housing projects. Although the purpose of the *World Bank Report* was to assist the government of Iran in aligning its housing policy with its overall national policy, the report does not touch on and has no comments about the codes with direct visual and practical effects on the urban environment. It recommends the revision of building codes, without specifying the aspects to which the revisions should be made. Therefore, it leaves the issue open as to which codes and procedures can be revised and simplified, and how. Now that the complication of the planning permission process has been explained, the development of Tehran and its important stages are next discussed.

In the period 1942 to 1979 (the rule of Mohamadreza Shah), the city underwent a massive growth

resulting from a huge migration from the rural areas. This started immediately after the Second World War and the occupation of Iran by the Allies in 1941. Their presence prepared the grounds for more development and the absorption of more population. In 45 years, the area of Tehran expanded 12 times and its population 8.6 times. This is a period when scholars widely believed that planning and planners had very limited control over the city and that they followed the city, rather than the city's growth being the result of any plan.

In this regard Madanipour noted:

'urban expansion in post-war Tehran was based on under-regulated, private sector driven, speculative development...The city grew in a disjointed manner in all directions along the outgoing roads, integrating the surrounding town and villages and growing new suburban settlements. This intensified social segregation, destroyed suburban gardens and green spaces and left the city managers feeling powerless' (Madanipour, 2006, p.434).

Madanipour (1998) argues that the post-Second World War period is the time of rapid and out-of-control development of Tehran, the further growth of suburban villages and satellite towns, and their gradual integration into the urban fabric (*ibid.*, p.65). Explaining this lack of control over the growth, Madanipour cites Nafisi (1964, p.426), who says how a deputy mayor of Tehran in 1962 commented that in this city 'the buildings and townlets have been developed by whoever has wanted and whatever way and wherever they have wanted' and the result is a number of settlements with weak connections between them (Madanipour, 1998, p.39-40). In the first years of this period the process of change was relatively moderate but continuous, whereas later it accelerated. The suburban areas developed in all directions and brought about a fragmentation of the city. There was an accelerating growth in private speculative housing, which tended to develop the suburbs with one or two-storey terraced houses

without any proper local planning. The increase in land value and the benefits of speculation in housing were considerable, so this business absorbed more investment.

The problem however was that the houses were built to a poor standard. They were mostly houses in row patterns with very similar plans to English terrace houses, which raises the question whether they might have been under the influence of British models, although the elevations are totally different. The houses have individualistic and diverse facades and the reason for these differences is that terraces were not built all at the same time and by one builder; they were built rather by different speculators, and therefore do not show unity in the street facade.

The influence of Western architecture and urban planning is believed to be important in the changes to and the development of Tehran during the 20th century. Madanipour (*ibid.*, p.340, 354) points to this influence in the employment of planners and architects who either were western or studied in the west. He mentions Paris as a very influential city in particular, together with German, British and American architecture. In this regard, he mentions British new town planning in general and Milton Keynes in particular as influential in neighbourhood planning practices for new areas in Tehran. Regarding speculations on the influence of Western architecture in general and British architecture in particular, Costello (1998, p.211-212) mentioned that plot sizes and street layouts (not house forms) invite parallels with North American rather than European morphologies. In addition, he noted about the 1968 Tehran Master Plan:

'we can now see parallels with other master plans of the period. The supergrid bears some comparison with the contemporary plans for Milton Keynes in the United Kingdom, though the scale of the total enterprise may have more in common with the great Paris Regional Plan of 1965. The

conscious attempt to create a hierarchy of service provision and neighbourhoods goes back even as far as the first Garden City in the UK at Letchworth' (*ibid.*, p.215).

2. Primary housing regulations in Tehran

Planning is a deliberate decision-making process that has determining effects on the built form of cities. Planning regulations and the way they are set in Iran, and Tehran in particular, seem to be very prescriptive and restrictive without appropriate logical reasoning. Housing regulations in Tehran are set out in a comprehensive large document covering various aspects and detailed issues. Following the introduction in the previous section, the major regulations applying to massing, spatial arrangement and density are discussed here, which are believed to have been instrumental in shaping the built form of the city. The following sections of this paper also investigate the reasons behind one of the most important set of planning regulations governing the spatial arrangement and massing of buildings in Tehran.

The critical point in this process is the way and extent to which legislation played a distinctive role in creating house types and transforming them. In 1953, for the first time in Iran, regulations were set governing massing and spatial arrangement in residential developments. Land subdivision created uniform parcels of land for some government

schemes where identical rows of buildings were built. The ratio for ground coverage was specified as 40 percent of the plot area on the north side. In other words, the rule allowed that up to 40 percent of the ground area of the plot could be built on, on its northern edge. The remainder was to be left open. The main purpose was to provide street access to each plot of land, since by that time car ownership had significantly increased.

The first master plan of Tehran (Farmanfarmaian and Gruen, 1968) suggested a linear extension of the city towards the west as opposed to its north-south axis of growth at that time. The implementation of this development was proposed through an extensive highway network and subway system. The control of the development was by the implementation of five-yearly interim plans. The residential developments would be a mixture of low, medium and high-density houses, together with offices, retail, entertainment and recreation. The smallest unit of community was defined by the catchment area of primary and secondary schools (*ibid.*). With this plan, new regulations came into effect to further limit ground coverage and building density. These regulations increased the building ratio to 60 percent of the plot area and specified again that the building had to be on the northern edge of the site. The remainder was again to be left open. This is when Tehran's population was growing faster and housing demand accelerated (Figure 2).

Figure 2:

Regulations and built forms governing open space on plots.

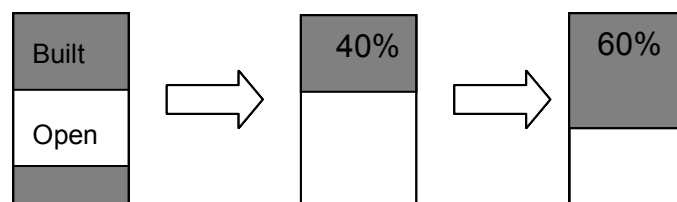

Some changes and addenda were introduced later, which are still in force. Their purpose is mainly to attain the maximum 'floor space index' (FSI) and maximum density. By floor space index, we mean the ratio of floor area on all floors to the ground area. For example, there is an additional two-metre building allowance to the length of the building (60 percent + 2 metres), subject to that line being connected with a 45-degree chamfer in plan to the edges of the plot (Figure 3).

The logic behind introducing this angle is to prevent adjacent buildings overshadowing each other. Here the question is how exactly this allowance relates to maximising density, while preventing overshadowing. This additional two-metre building allowance increases the FSI value. The 45-degree angle in plan is put in force because adjacent plots might have been developed prior to this legislation (on the 60 percent building allowance) and thereby have frontages further back (Figure 4).

This raises the question as to why the regulation specifies that buildings should be on the north side. Our investigation shows that there seem to be two reasons. The first is a concern about the angle of sunshine and the maximum exploitation of the sun in winter both for the gardens and the interiors of houses. The point is to let winter sun deliver its maximum heat to the building. A second issue is the functionality of garden (yard), on the premise that it is ideal to have sunshine in a garden. Therefore by having the building always at the northern side of the plot, it would seem possible firstly to provide sunshine both for the garden and for the building, and secondly to ensure that houses on both sides of the road have the same conditions in relation to sunshine. If on both sides of street the building is on the street front and the garden behind (as in British examples), then in the plots at the north side of the street, the buildings would create shadows on the gardens and prevent them having sunshine. The other reason put forward for this regulation was

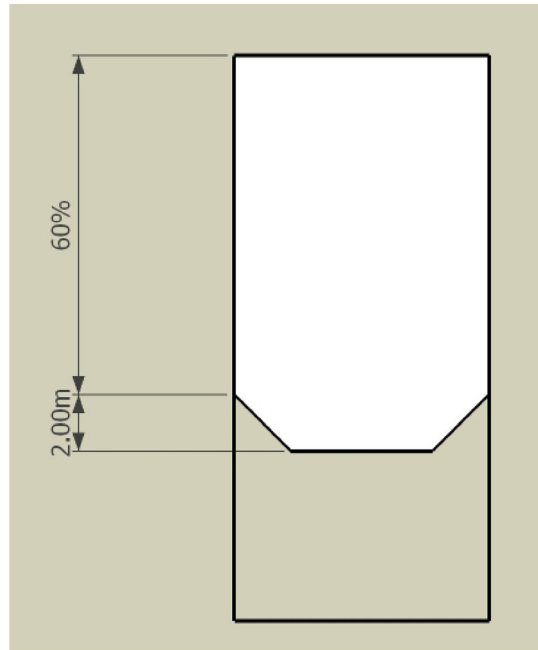

Figure 3:
A typical plot of land in Tehran and the most recent ground coverage rule.

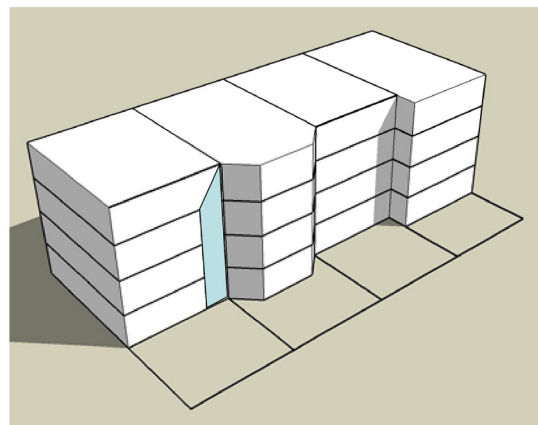

Figure 4:
Prevention of overshadowing (in the area shown in light blue) by implementing a 45-degree chamfer angle in plan.

the strength of sunshine arriving from the west in the afternoons in Tehran. Houses facing west get unbearably warm and this has led to a general belief that buildings should face south.

These considerations on the one hand seem to come at the price of neglecting the architecture of streets, since one side is lined by building facades

and the other side by the walls and fences of yards. On the other hand, these rules had a very direct and powerful impact on housing typology, and one could say that they introduced and dictated a type which highly affected the *urban built form*. It seems necessary to mention that the term 'urban built form' here refers to the aggregation of individual built forms, and that the term *built form* itself - invented by Lionel March - refers to the external envelope of a building and to mathematical models for representing buildings in theoretical studies (March, 1972).

The arrangement of buildings on plots of land shapes the built form of the city. In the case of Tehran specifically, the ground coverage, height and, last but not least, the location and orientation of buildings within sites are dictated by planning codes. This leaves architects and designers few options as to what they can create and also makes one think that perhaps planners had specific house types in mind when dividing the land and setting the regulations. It is also important not to forget the role of limits that some 'generic functions' like access and day lighting have had in defining the built form of the city, although they are not the focus of this paper.

There is another regulation regarding the provision of patios at the end of plots (on the southern sides of blocks). Such patios allow the back rooms to have access to an open space on the ground floor, and windows to the light well above the patio on upper floors. To that end, it is not permitted to have any windows opening onto adjacent plots. There are minima for the length and width of the patio, usually two to three metres, depending on the dimensions of the plot. However, this does not change with an increase in the number of storeys. Therefore, in taller buildings the light wells above the patios become extremely deep for their plan dimensions. Later on, the regulation was amended to accommodate car parking for multi-storey mid-rise apartments. In fact, single or double occupancy

plots used to allow for one or two cars to be parked in the garden, whereas later with increasing density it was necessary to make special arrangements for car parking. Therefore a new generic form emerged in the 1980s which raised the lowest floor on *pilotis*, allowing for cars to be parked beneath. There is also the option for underground parking if the dimensions of plot allow for a ramp with an appropriate slope. Interestingly, this regulation does not differentiate between corner plots and terraces, treating them the same, which is the direct consequence of a unified regulation. The only difference regarding corner plots is that the internal layout of apartments may be organised so that all rooms and services can have windows and can therefore also be naturally lit and ventilated from the side.

It is important to note here that land use usually has no effect on the regulation applying to massing and spatial arrangement except for complex projects or when an entire block is devoted to commercial or office use. The only difference for commercial or office buildings built on standard plots along the streets is that they are allowed to be higher while maintaining the same ground coverage, subject to paying a compensation for the additional density. This makes the street facades yet more uneven, as there can often be a commercial building of ten storeys adjacent to a five-storey residential block. Another important issue to note here is the average height of residential buildings. Figure 5 shows the average number of storeys per planning permission in different boroughs of Tehran between 1993 and 2001. According to the graph, the average number of storeys per planning permission in different districts (boroughs) varies from under 3 to over 4.5 storeys. The overall average is 3.75 storeys. Here we hypothesise that this figure could be related to the regulation of lift installations. An important regulation was set in 1967 that required buildings of over four storeys to install a lift. This could be the reason behind four storeys being the

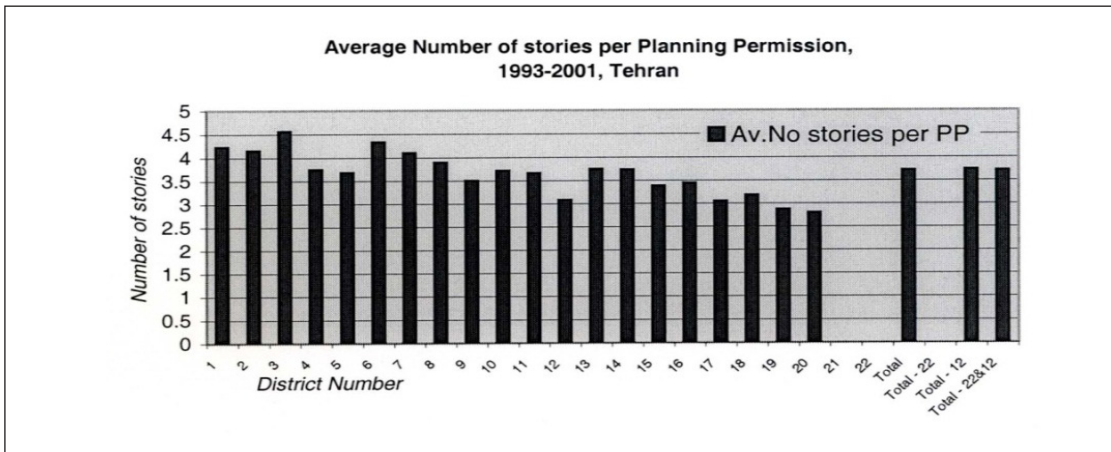

Figure 5:

Source: Sharan Architects Co.

average number of storeys in residential planning applications throughout Tehran.

Usually on residential plots, local authorities will allow a maximum of five storeys. This one additional floor does not justify the significant cost of lift installation; therefore four storeys remains the most popular height in planning applications.

As a final point, it seems that there is a meeting point for economic, social and technological forces with regulation and consequently the built form of the city. The main driving force behind the demolition and rebuilding of houses for the owners who themselves become developers is to make profits on the price of land and generate additional income. This process of course also provides them with more modern accommodation in which to live. Profit is maximised by building the maximum possible floor area. That is why building in masonry was replaced by steel and concrete structures. Using these technologies, developers could build higher, faster and safer in the case of earthquakes. What was also achieved by these methods of construction was to obtain yet more valuable floor space because the walls were much thinner than in masonry construction.

3. Investigation into the logic behind some regulations

This section aims firstly to explore why buildings should be placed on the north sides of plots; and secondly, what the logic is behind the 40 or 60 percent limit on ground coverage? The reason behind this investigation is that those rules, as set and governed today, are unconditional in their application with no respect to the land use and location. Moreover, the effect they have had on the overall morphology of the city and its streetscape has been huge. The built form of Tehran, which had started changing historically through the development and implementation of new road networks, was later transformed significantly by the implementation of the master plan and its regulations. Scholars, architects and academics generally agree that these regulations helped to shape the built form of the city. However, there seems to be no indication as to the references and origins of the regulations. The only point of reference is some speculation about the probable source for building on the north side of the plot being related to some climatic factors that were mentioned in the *Habitat Bill of Rights* (Ardalan et al., 1976) as explained below. The *Habitat Bill of*

Rights was referred to as a valuable source that could explain the climatic and positioning aspect of the regulations. The government documents that are used in combination with the housing regulation booklets make no reference, however, to the logic behind the codes.

4. Why mass of building on the north side of the plot?

This section hypothesises that the reasons for this legislation relate to environmental considerations. There is some evidence that this regulation has to do with climate and the results of the regular grid structure where the reasons for its use, it is speculated, are other than a simple desire for order (Costello, 1998). Costello cites de Planhol (1968) who says,

'the most desirable orientation for a house is east-west at right angles to the mountain breeze, which is essential for freshness in summer and must be allowed to pass freely through the dwelling at night. It is also preferable, on account of the winter cold, for the main facades of the house to face south. Building plots must therefore be orientated north-south, with the house built at the northern end facing the garden, which occupies the whole of the southern part. It follows that the roads should run east to west (bordered on the south by the rear walls of houses and on the north by garden gates) and be cut from north to south by broad avenues that carry the principal irrigation channels. The orientations of the houses with regard to the winds, and the consequent shape of the plots, have thus confirmed the strict chequerboard pattern of the streets. Reza Shah's network, based originally on the limits of properties, which have been conditioned by natural circumstances, has therefore been extended with absolute clarity throughout all the new sectors of the city' (Costello, 1998, p.208-209).

Both garden (yard) and building were thought to get more sunshine in winter and more shade in summer if the building mass was located on the north side of the plot. In many documents, this code

is considered as a climatic code; however, it has never been demonstrated that this is the only way of achieving the desired results.

Christopher Alexander in *A Pattern Language* (1977) discusses this issue in a chapter called 'South Facing Outdoors'. He mentions that 'this pattern governs the fundamental placing of the building and the open space around it with respect to the sun' (Alexander, 1977, p.514). He declares that people use open space if it is sunny and do not use it if it is not, in all but desert climates. Although building on the north side of the plot in Tehran predates Alexander's book, this same line of thought could be the reason for the imposition of this regulation in Tehran.

In *A Pattern Language*, emphasis is put on the best placing of the building within the site in order to maximise usability. On the other hand, if the building is not placed correctly, beautiful detailing will not make it a vibrant space. Alexander says elsewhere '[t]housands of acres of open space in every city are wasted because they are north of buildings and never get the sun. This is true for public buildings, and is true for private houses' (*ibid.*, p.514). So Alexander not only suggested this pattern for public buildings, but also clearly for private houses. He brings evidence from a survey of a residential block in Berkeley, California, that confirms the problem of outdoor space on the north sides of houses. This showed that 18 out of 20 people interviewed said they used only the sunny parts of their yards, and half of them did not use their north-facing yards at all except for storing junk.

Later on, Alexander mentions that the idea of south-facing open spaces, however simple, has great consequences and requires major changes in land use. He shows examples of how residential neighbourhoods would have to be organised quite differently. He also suggests that private lots would have to be made longer north to south, with houses on the north side.

Alexander notes later that the significance of this pattern varies with changes in latitude and climate. He brings examples to show that in Europe, at about 50 degrees latitude, the pattern becomes more essential. He says,

'[I]n desert climates, the pattern is less important; people want to stay in outdoor spaces that have a balance of sun and shade. But remember that in one way or another, this pattern is absolutely fundamental. Therefore: Always place buildings to the north of the outdoor spaces that go with them, and keep the outdoor spaces to the south. Never leave a deep band of shade between the building and the sunny part of the outdoors' (*ibid.*, p.516).

Figure 7, taken from page 515 of *A Pattern Language*, corresponds to the reality of block layout in most Tehran's residential areas. It seems that although Alexander emphasises the clear effect of differences in climate and latitude, his conclusion is clear and prescriptive with no regard to the adjacent streets. As seen in Figure 7, the north-south street does not have a continuous facade, and constantly interchanges between buildings and their open spaces.

In the regulation of building bulk in Tehran, although the climate is neither like California nor like a desert, it is very possible that this line of thinking may have been applied to the decision of how to position the building within the site.

There is also evidence that in 1976 the code was specifically mentioned as a climatic solution to building mass arrangement according to the document the *Habitat Bill of Rights* (Ardalan et al., 1976), prepared and submitted by the Government of Iran to 'Habitat 76', the *UN Conference of Human Settlements* in Vancouver, Canada in June 1976. The editorial board for this document, which was initially prepared by the Ministry of Housing and Urban Development, included Nader Ardalan, Jose Luis Sert, Balkrishna Doshi, Moshe Safdi and George Candilis.

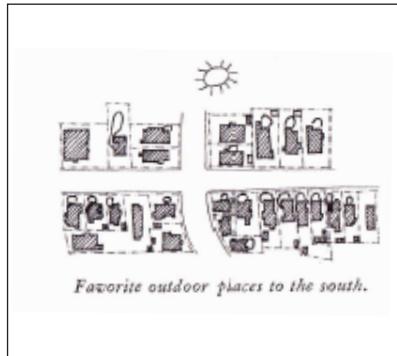

Figure 6:

Favourite outdoor places to the south.

Source: Alexander (1977, p.515).

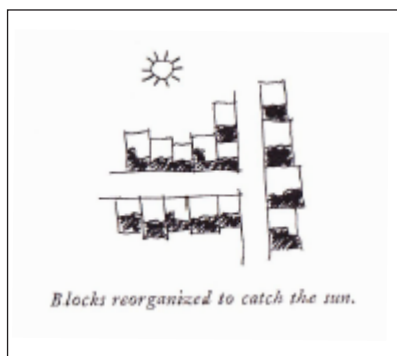

Figure 7:

Blocks reorganised to catch the sun.

Source: Alexander (1977, p.515).

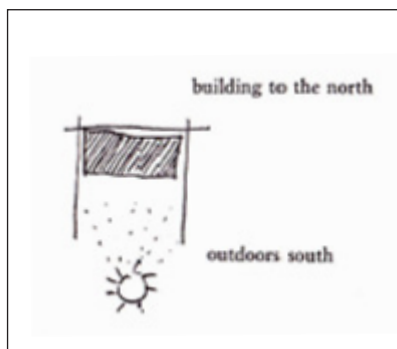
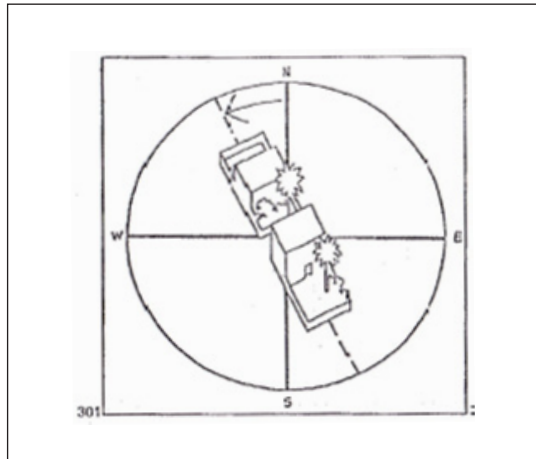

Figure 8:

Placing building and open space.

Source: Alexander (1977, p. 516).

Figure 9:**Correct solar –
wind orientation
as an important
consideration.***Source: Habitat
Bill of Rights
(1976).*

The *Habitat Bill of Rights* has two important environmental recommendations for dwellings. First is the correct solar orientation. The second emphasises that the adaptive location, size and type of openings can greatly increase comfort conditions in dwellings. The document clearly states that 'to minimise the effects of the hot sun and maximise the effects of the cool breeze, houses should seek a compact cubic volume with their openings oriented principally to the south easterly and north westerly directions' (Ardalan et al., p.158). It also recommends that the patios and courts of dwellings should have the same orientation and the long facades without openings in them should face east and west. The document further suggests that openings should be externally screened or protected, and overhangs and screens should be used to prevent the penetration of the sun and reduce glare. It mentions that openings, including ventilation openings, should face the prevailing winds to capitalise on their natural cooling effects. Moreover, it says that the need for mechanical cooling in the dwelling should be minimised by correct orientation, size and location of openings and high insulation value of walls and roofs (Ardalan et al., p.158).

It is important here to clarify that the argument of this paper by no means states that these above-

mentioned documents influenced the legislation, as they occur much later (1970s) than the introduction of the Tehran Code in the 1950s. However, they do seem to confirm the hypothesis that the reasons for the legislation are connected with environmental considerations in relation to orientation and maximisation of sunshine in open spaces.

GIS analysis of ground coverage in three 500 x 500 metre sample areas in three boroughs of Tehran (12, 11 and 2) representative of its successive stages of development revealed that in Borough 12 the value for ground coverage was 61 percent, despite the fact that this borough's ratio had not initially been governed by regulation. Borough 2, the complete example of recent town planning which was totally governed by regulations, showed a result of 63 percent for ground coverage. One can speculate that the panel of experts could have calculated the existing ground coverage of the densest existing part of the city, and based the new regulation on that figure. Borough 11 showed ground coverage of 54 percent, which represents a decrease connected with the fact that maintaining vehicular access to each single-family house was the primary driver of regulations in that period (Shayesteh and Steadman, 2012).

5. Example of a conflict

Amalgamation of plots has recently been greatly encouraged in Tehran, if two neighbouring owners both intend to develop their properties. This is beneficial for both owners, as they maximise their valuable and usable floor area by saving on spaces like a shared communal staircase, lift, lobby, and car park entrance and ramp. An incentive in this scheme is the reward of an additional floor allowance free of charge. This means that if the usual density in an area is four storeys above *piloti*, when two plots are combined and the owners submit a collective planning application form, they will be allowed to build on five storeys above *piloti*. This has happened, as

we can see in the map below, in many parts of the city where the plots have become almost double the width. Figure 10 shows part of Borough 2 in our study area.

In a conversation with one of the planning officers for that borough (Mr. Behnam Anvari, 2009), he pointed out one of the unforeseen problems of Tehran's planning regulations (on building on 60 percent of the plot on the north of the site) that was caused by the amalgamation scheme in Borough 2. Due to the fact that this was a court case and covered by confidentiality law, he could not reveal the actual location of the plot, however the case is explained below.

A similar hypothetical case can be illustrated by using the previous map (Figure 10). An owner of a plot bought another neighbouring plot of land, but on the other side of the block. The owner applied, as was her legal right, to build 60 percent of the length of the new plot plus two metres from the north (shown in red in Figure 11).

The resulting problem was that the two adjacent neighbours on the north side of the block would get their entire backyards and therefore their buildings overshadowed by the proposed new building. They also were made aware of the application and had registered their complaints. That particular case has not yet received permission and the likelihood of issuing one on this basis remains very low. The purpose of this example is to re-emphasise that simple planning codes may result in very complex issues, and that in enforcing those codes, careful considerations should be made and possible ramifications studied before they are implemented.

6. Discussion: regulation as an important shaping force in the evolution of building and urban form

With the challenges that contemporary urban areas pose, planning regulations are inevitable and potentially useful tools in ordering cities. Talen (2012) argues that whether the effects of building

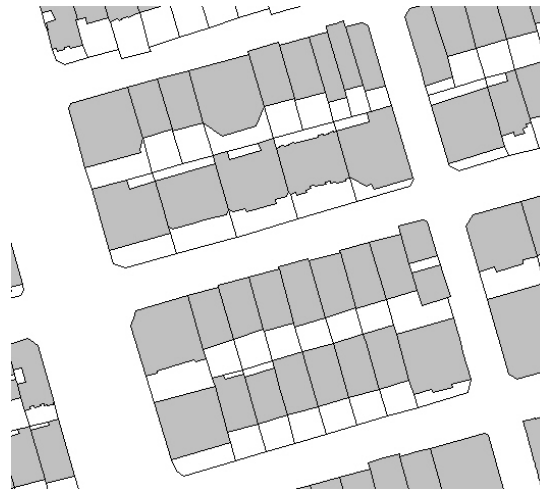

Figure 10:

Block layout in Borough 2 showing the amalgamation of plots.

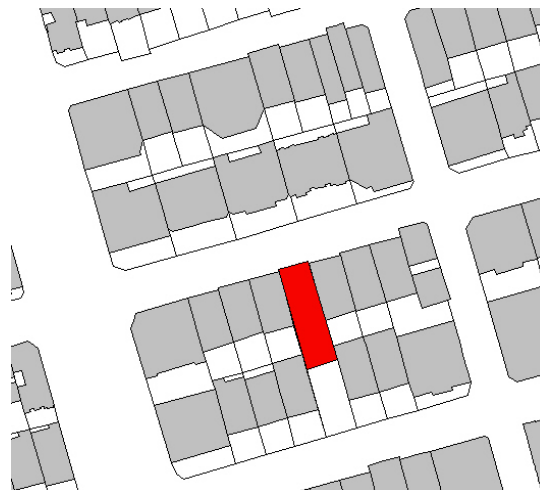

Figure 11:

Example of a conflict in amalgamation of plots, Borough 2.

codes are good or ill, the codes are necessary and their relationship to urban patterns and forms are explicit and direct. This paper has discussed the profound effects of building regulations as one of the important forces in shaping building form in Tehran. While certain regulations, it seems, tried to answer the need for street access and maximise the use of space, others were put in force to respond to development pressures and the demand for

higher densities. However, these have often been at the price of neglecting visual effects regarding the overall built form of the city. It was also found that climatic reasoning – which we speculated to be the logic behind the positioning of the mass of built space at the north end of plots - can be questioned, and that north should not be the only position for the mass of building.

Regulations have proved to be a strong and influential shaping force in the evolution of building forms. While buildings should comply with regulations of their time that limit their positions within the plot, as well as the ground coverage and the number of storeys (FSI), together with the forces of property values and maximisation of space in a highly demanding market, then if the regulations are tight, the result is bound to be uniformity of appearance. But is that always a negative thing?

Similar results have been found in a morphological study of Hong Kong made by the University of Hong Kong in 2005 (Steadman, 2005). In that project, a similar approach to this study has been used and building forms in the high-density areas of Hong Kong were studied throughout the city's consecutive stages of growth. The impact of planning codes and building regulations for different types of buildings were examined and it was found that these had strong effects on the final shape of buildings and the city.

Overall, it is clear in such cases that planning control and regulations limited architects' freedom in their design of buildings, as they often had little room for manoeuvre to create something different within the very tight limits of the regulations. However, one could argue that the aesthetic results of such uniformity of appearance could be sometimes positive. On the other hand, in the case of Tehran, the corresponding restrictions did not result in uniformity of appearance.

The discussion can be widened further with examples from Paris and New York. Building regula-

tions in Paris created the uniformity of Haussmann's boulevards. The 1916 Zoning Ordinance in New York governing the bulk and height of buildings created the 'setback style' of skyscraper in Manhattan in the 1920s and 30s. The aesthetic results in both cases could be regarded as positive, despite the limits placed on architects' freedom and creativity.

In the case of Paris, conformity and continuity in the facades and the appearance of buildings, in particular houses, in the late 18th century have widely been admired. The tight regulations, which prescribed the maximum height of buildings and the height of each floor, did not leave great freedom for architects. However, the restrictions were made in relation to the width of the streets and were enforced to address hygienic as well as aesthetic considerations. Sutcliffe (1993) notes: 'the building code of 1783/4 was not the first attempt to fix maximum frontage heights for houses facing onto Paris streets. It was however, the first to relate maximum height to street width'. The maximum height was defined by drawing a line at an angle of 67.5 degrees from the building line to the top of the opposite house. It was also required at this time that owners or developers submit the plans to apply for building permission and an administrative procedure for this was put in place. Sutcliffe also argued that 1783/4 was a turning point in the architectural history of Paris because it was at this time and thereafter that the mass production of housing became a major concern of the local authorities and also architects. Architects had to respond by producing the best results within the tight limits of regulations. He believes that '[t]he shaping of nineteenth-century Paris begins in the 1780s' (Sutcliffe, 1993).

The regulations resulted in harmonised horizontal lines in street facades, producing a local uniformity. Moreover, Haussmann used one or more influential buildings in a street to specify the general lines which other buildings were expected to follow. The legislation implied that elements of facades

such as windows, balconies and other horizontal lines would become unified in height. That is how the so-called Haussmannian Boulevards of Paris took shape. Such architecture within the restrictions of regulations, despite looking repetitive, allowed for some variety in the interiors.

In the case of New York, the *1916 Zoning Ordinance* made three types of provision: for different uses (residential, business and unrestricted) to be segregated, for provision of minimal amounts of open space around buildings, and finally for the heights of buildings. In Carol Willis's phrase, constraints were created by 'light, height and site' (Willis, 1993). These provisions resulted in the creation of a 'setback style' that became very widespread, in which the height rules had the greatest effect. This style was forced on designers. It is not within the scope of this study to explain the zoning law in detail; the interested reader is referred to *The Zoning Regulations in New York* by Thomas Hastings (1920) or *Form Follows Finance* by Carol Willis (1995), from a large literature.

In summary, the height rules meant that if a building was made taller than a specific height (varying in different zones of the city and being related to the width of the street), it had to be sloped back. In practice, the buildings were stepped back progressively every few storeys as determined by the depth of the structural bay, so creating ziggurat forms. The Ordinance also limited the maximum area of ground to be covered by buildings. Unlike the case of Tehran, this ratio varied between different use districts. It also varied between corner sites and other kind of sites. It specified that in terrace sites, the open space (10 percent of the ground area) had to be at the rear of the building to create a light well. Minimum limits on width were also set for interior light courts.

The point however is that this law was very restrictive in defining many aspects of buildings such as ground coverage, the positions of and

dimensions of light wells, the heights of buildings etc., which is comparable to Tehran's code in some respects. What is interesting here is that unlike Tehran's case, in New York these limits became instrumental in the emergence of a visual harmony and the formation of a style that has been mentioned positively in the architectural literature.

Ely Jacques Kahn (1926) in appreciation of the fact that skyscrapers take simple forms said, '[m]iraculously groups like the millinery buildings on Thirty-seventh, Thirty-eighth and Thirty-ninth Streets gather and poke their heads together in the air...They are fantastic in their grouping'. Harvey Corbett (1921) pointed out that where previously designers would have given their attention only to the facades of buildings facing onto the principal thoroughfares, neglecting their sides and backs, using the Ordinance and applying it to all street facades encouraged uniformity and a sculptural approach.

Initially in 1916, soon after the Ordinance came into force, architects struggled to work with it and its implications. Some architects started studying the envelopes and massing effects of different schemes and made some experiments with different formal possibilities. However, by the middle of the 1920s the 'setback style' was really emerging in practice, and designers and clients eventually became eventually more convinced about it even though they had to sacrifice floor area to conform to the Ordinance. It became so widespread that even builders prepared 'the legal possibilities' for any site and presented them to clients for selection.

Hugh Ferriss, as a famous illustrator/perspectivist whose ideas, analysis and drawings were widely publicised in relation to the codes, noted in an interview that 'the laws create a unique situation – 'restricting' in nature, they are producing a profound evolution in architecture'. He also said 'the strange part of the business is that these laws, which had no concern whatever with aesthetic considera-

tion, have had a tremendous aesthetic reaction...’ (Ciolkowska, 1925).

In other words, despite the fact that designers only had room to play with the positioning of light courts and the detailed design of facades in situations where usually developers wanted to fill the maximum legal envelope, the designers felt they had found enough space for creativity within the tight boundaries of the code and remained enthusiastic about it.

7. Conclusions: lessons for and from Tehran

To sum up, looking at the examples of New York and Paris, it is important to state that although the Tehran regulations did not aim to influence the aesthetics of buildings and in theory only covered their physical aspects, the appearances of buildings have been greatly influenced by them. The prototypes resulting from these regulations shape the built form of the city at the larger scale.

In the Paris case, it was clear that the regulations were framed with aesthetic effects in mind. In New York, aesthetic considerations were not uppermost, and the ‘setback style’ was largely unanticipated. However, the law in Tehran has not created a uniformity in facades for the reason that in older parts of the city, some plots have been re-built where neighbouring plots have not. Furthermore, additional floors have been allowed where developers have been able to pay some premiums. This has created, as we saw in Figure 1, some very unharmonised street facades. So, it is arguable that due to the profound implications of regulations on building forms on parts of the city and the cityscape as a whole, planning codes and building regulations should take into account the ultimate aesthetic effects they may bring about.

When taking into consideration the aesthetic aspects of the city and the street facade, one might argue for the alternative option of maintaining the street facades by building on the edges of blocks

and concentrating the open space at the centres of blocks. This can provide the same levels of density, but the question is what exactly are the merits of this alternative?

In simple terms, having a larger open space at the centre of the block provides better and more even natural lighting and sunshine for all rooms at the backs or fronts of plots. Specifically, the back rooms of the southern row of plots in a block, that would presently get their natural light from a deep, tall light well, have the chance to be opened up to a better and larger open space.

In conclusion, some aspects of the above mentioned regulations might seem to be rather impulsive short-term remedies for problems of their time. They appear neither well thought-out, nor do they betray much general insight and provision for what their probable outcomes might be, as to how and on what scale they might influence the aesthetic of the city as a whole. Positioning buildings only on the north sides of plots has been interpreted - although this is not completely proven - as a form of environmental and climatic regulation. However, if that is true, its prejudice in ignoring other aspects of urban layout does seem questionable. It could well be an aspect of building codes that according to the *World Bank Report* needs revision (World Bank Report, 2004, p.138). A change in current planning legislation controlling the positioning of building in plots, considering instead the street facade, would create an aesthetically better skyline for the streets of Tehran, providing more alternatives for the massing of buildings and their densities.

In this paper, discussion has been focussed on planning codes and building regulations. These were found to have had great influence in shaping house types that have emerged over the last few decades. It was also found that the regulations that seem just to be simple planning codes, have had profound effects on housing typology and building forms, and that those effects were often not con-

sidered at the time of setting the regulations. This indicates the prime importance of planning and the challenge planners face in setting out rules.

We have proposed some specific changes to the existing regulations in Tehran that would ameliorate the problems they cause. More broadly, we see the prospect for a systematic approach to the interactions of regulations with urban built form, that would explore a wider range of theoretical options for block and plot shape and size, possible building geometry, and possible positions for buildings on plots. Work to date uses a computer model of an 'archetypal' block (Steadman and Marshal, 2005) and building layout. Some applications to Tehran will be published in a future paper.

About the authors:

Homeira Shayesteh

(h.shayesteh@ucl.ac.uk) is a post-doctoral research fellow at UCL working as Knowledge Exchange Associate collaborating with Autodesk and Bartlett. She is investigating BIM (Building Information Modelling) data throughout project life cycle with a focus on Facility Management and Space Syntax. She obtained her PhD in Architectural and Urban Studies from the Bartlett, where she focused on the transformations of urban layouts and housing built forms using GIS and archetypal modelling. Homeira trained as an architect and has years of experience in applied research and practice in the built environment, through which she specialised in spatial analysis and observational/surveys of buildings and urban spaces in relation to their environmental performances and from users' perspective.

Philip Steadman

(j.p.steadman@ucl.ac.uk) is Emeritus Professor of Urban and Built Form Studies at the Bartlett School of Graduate Studies, University College London, and a Senior Research Associate at the UCL Energy Institute. His research interests are in the geometry of buildings and cities, and their use of energy. He has published two books on geometry and architecture: *The Geometry of Environment* (with Lionel March, 1971), and *Architectural Morphology* (1983). His study of *The Evolution of Designs: Biological Analogy in Architecture and the Applied Arts* was

References

- Alexander, C., Ishikawa, S. and Silverstein, M. (1977), *A Pattern Language*, New York: Oxford University Press.
- Ardalan, N., Sert, J. L., Doshi, B., Safdie, M. and Candilis, G. (1976), *Habitat Bill of Rights*, Presented by Iran.
- Chatterton, I., Chiquier, L., Razzaz, O., Renaud, B., Taffin, C. and Vecvagare, L. (2004), 'Iran; Strategies for the Housing Sector, World bank', International Bank for Reconstruction and Development, Islamic Republic of Iran, Ministry of Housing and Urban Development, 28983.
- Ciolkowska, M. (1925), 'Hugh Ferriss and the zoning laws of New York'. In: *The Architectural Review*, Vol. 58, p.174-177.
- Costello, V. F. (1998), 'The morphology of Tehran: A preliminary study'. In: *Built Environment*, Vol. 24 (4), p. 201-216.
- Corbett, H. W. (1921), 'High buildings on narrow streets'. In: *The American Architect*, Vol. 119, p.603-619.
- Planhol, X. d. (1968), 'Geography of Settlement'. In: Fisher, W. B. (ed.), *The Cambridge History of Iran, The Land of Iran*, Vol. 1, Cambridge: Cambridge University Press.
- Farmanfarmaian, A., Gruen, V. (1968), *Tarh-e Jame-e Tehran (The Master Plan of Tehran)*, Tehran: Sazman-e Barnameh va Budgeh (Institute of Planning and Budget).
- Kahn, E. J. (1926), 'Our skyscrapers take simple form'. In: *New York Times*, Vol. 4, p.22.
- Madanipour, A., (1998), *Tehran: The Making of a Metropolis*, Chichester: John Wiley & Sons Ltd.
- Madanipour, A., (2006), 'Urban planning and development in Tehran'. In: *Cities*, Vol. 23 (6), p.433-438.
- March, L. (1972), 'Elementary models of built forms'. In: Martin, L. and March L. (eds.), *Urban Space and Structures*, Cambridge: Cambridge University Press, p.55-96.
- Nafisi, A. (1964), 'Shahrdari-e Tehran'. In: Institute of Social Research and Study (ed.), *Masa-el-e Ejtemai-e Shahr-e Tehran, A colloquium*, Tehran: Tehran University Press, p. 426.
- Shayesteh, H., Steadman, P. (2012), 'Typo - morphological analysis of housing layout and density in Tehran'. In: *International Conference of Urban Change in Iran*, Development Planning Unit, University College London.
- Shayesteh, H. (2013), *Typo-morphological Approach to Housing Transformation in Tehran*. Unpublished Doctoral Thesis, London: Bartlett School of Graduate Studies, University College London.
- Steadman, P. (2005), *Linear City: A morphological approach*, Hong Kong: University of Hong Kong, Volume I.
- Steadman, P. and Marshall, S. (2005), 'Archetypal layout: Extending the concept of the archetypal building to streets and block layouts'. In: *SOLOUTIONS Conference*, London, December 2005.
- Sutcliffe, A. (1993), *Paris: An Architectural History*, New Haven and London: Yale University Press.
- Talen, E. (2012), *City Rules: How Regulations Affect Urban Form*, Washington: Island Press.
- Willis, C. (1993), 'Light, height and site: The skyscraper in Chicago'. In: Zukowsky, J. (ed.), *Chicago Architecture and Design, 1923-1993: Reconfiguration of a Metropolis*, Munich: Prestel and Chicago: The Art Institute of Chicago, 1993, p.119-139.
- Willis, C. (1995), *Form Follows Finance: Skyscrapers and Skylines in New York and Chicago*, New York: Princeton Architectural Press.

republished in an updated edition in 2008.

He has just completed a book about building types, considered from both historical and geometrical points of view, with the title Building Types and Built Forms.