

# Modeling the Physiological Factors That Affect Drug Delivery from a Nipple Shield Delivery System to Breastfeeding Infants

STEPHEN E. GERRARD,<sup>1</sup> MINE ORLU-GUL,<sup>2</sup> CATHERINE TULEU,<sup>2</sup> NIGEL K. H. SLATER<sup>1</sup><sup>1</sup>Department of Chemical Engineering and Biotechnology, BioScience Engineering Research Group, University of Cambridge, New Museums Site, Pembroke Street, Cambridge CB2 3RA, United Kingdom<sup>2</sup>University College London, School of Pharmacy, Department of Pharmaceutics, London WC1N 1AX, United Kingdom

Received 9 June 2013; revised 12 July 2013; accepted 12 July 2013

Published online 11 August 2013 in Wiley Online Library (wileyonlinelibrary.com). DOI 10.1002/jps.23688

**ABSTRACT:** An apparatus was designed to mimic lactation from a human breast. It was used to determine the influence of milk fat content and flow rate, and suction pulse rate of a breastfeeding infant upon the release of a model compound from a nipple shield delivery system (NSDS). The NSDS would be worn by a mother to deliver drugs and nutrients to her infant during breastfeeding. Sulforhodamine B dye (SB) was used as model compound and formulated as a dispersible tablet to be placed within the NSDS. Increasing suction pulse rate from 30 to 120 pulses/min clearly correlated with increased cumulative release of SB for the same volume of milk passed through the NSDS. No distinct correlation was found between flow rates (1, 5, and 8 mL/min) and SB release, possibly because of competing factors controlling release rate at different flow rates. A highly similar SB release rate into two fat content fluids (2.9 and 4.2 wt %) was observed for identical flow conditions. This proof of concept study outlines a novel method to mimic lactation from a breast, and future studies will lead to effective methods to identify key physiological factors that influence drug release from a NSDS. © 2013 Wiley Periodicals, Inc. and the American Pharmacists Association *J Pharm Sci* 102:3773–3783, 2013

**Keywords:** Controlled release/delivery; drug delivery systems; *in vitro* models; lactation; nipple shield delivery system; oral drug delivery; pediatric

## INTRODUCTION

### Difficulties in Infant Drug Delivery

New drug delivery systems are urgently needed for the treatment of pediatric diseases, especially in developing countries.<sup>1,2</sup> Each year more than 7.6 million children under 5 years die worldwide from diseases that could often have been prevented if they had access to appropriate forms of simple and affordable medicines.<sup>3</sup> Liquid formulations are typically the principal method for pediatric drug administration, but are often not practical in developing countries because of sterility issues, high cost, lack of access to refrigeration, and limited shelf life.<sup>4–6</sup> They may also be unpalatable and contain toxic preservatives and solvents. Solid oral dosage forms for infants are also often scaled down from adult doses, and there is currently a debate on the limitations of clinical work performed to demonstrate suitability of the dose to infant.<sup>7,8</sup> Dispersible tablets can also be used, but require sterile sources of water and administration devices.

### Nipple Shield Delivery System

This paper outlines the development of experimental research to guide the design of a recently proposed novel drug and nu-

trient delivery system intended to be used for breastfeeding infants—a nipple shield delivery system (NSDS).<sup>9,10</sup> This thin disposable device adapted from an existing nipple shield breastfeeding aid is placed over the mother's breast just before infant feeding, and when milk passes through the device it releases the agent to be delivered to the infant via the breast milk. A wide-range of active pharmaceutical ingredients (APIs) could be delivered to infants using the NSDS such as antibiotics, antivirals, antimalarials, vitamins, nutrients, and probiotics while stored in a dry form. The NSDS has the potential to remove many of the issues related to maintaining sterility and stability of drugs delivered to infants in developing countries.

The NSDS would most likely be in a single-use form for low-resource settings, as there may be difficulties in ensuring sterile repeat use. The device will have to be designed to ensure dosage is attained well within all typical feeding behaviors. Future clinical studies will determine the most appropriate device design and technique for effective use to ensure no disruption to the infant's normal breastfeeding behavior. A color indicator, which is only apparent once a critical dose has been delivered, could be contained within the NSDS for the mother to identify when the critical dosage has been achieved.

Previously, the effective delivery of the anti-HIV microbicide sodium dodecyl sulfate from a nonwoven NSDS insert into simulated breastfeeding fluid flow conditions, as well as subsequent inactivation of HIV, has been demonstrated.<sup>10</sup> The potential of antiviral polycationic coatings in a NSDS for use in inactivating the free virus from milk has also been examined.<sup>11</sup>

In the present study, the delivery of a model drug mimic from a tablet placed within the NSDS has been examined using an apparatus that simulates the fluid dynamics of breastfeeding. To our knowledge, there are no previously published details of an apparatus of this form, that mimics the suction of the

**Abbreviations:** HNM, human nipple mimic; NSDS, nipple shield delivery system; SB, sulforhodamine B.

**Correspondence to:** Stephen E. Gerrard (Telephone: +44-1223-763969; Fax: +44-1223-334796; E-mail: stephen.gerrard@cantab.net)

This article contains supplementary material available from the authors upon request or via the Internet at <http://onlinelibrary.wiley.com/>.

*Journal of Pharmaceutical Sciences*, Vol. 102, 3773–3783 (2013)

© 2013 Wiley Periodicals, Inc. and the American Pharmacists Association

This is an open access article under the terms of the Creative Commons Attribution License, which permits use, distribution and reproduction in any medium, provided the original work is properly cited.

infant, and the lactation of milk from a human nipple induced because of this suction. The influence of an infant's tongue during breastfeeding is also an important element to consider and is described in the discussion.

### Physiological Factors Influencing Tablet Release from a NSDS

Many physiological factors vary during breastfeeding and between infants and their mothers that may influence the rate of delivery of a therapeutic from a NSDS to the feeding infant (i.e., they influence the dynamic behavior of milk contacting a NSDS tablet containing the drug). These include nipple size and duct structure,<sup>12</sup> feeding behavior allowed by the mother, suction pulse rate of the infant, flow of milk out of the breast,<sup>13</sup> and importantly the potential changes in feeding behavior of the infant in response to foreign tasting agents from the NSDS (which may support the addition of taste-masking excipients to increase acceptability).

This study focuses on the influence of fat content and flow rate of milk, and the suction pulse rate of the infant, three factors known to vary significantly between infants and during a single breastfeed.

### Changes in Fat Composition

Human milk's main constituents are fat (triacylglycerol lipid globules with a phospholipid-protein membrane), protein (caseins and whey—including enzymes and immunoglobulins), and several forms of carbohydrates (primarily lactose).<sup>14–16</sup> The fat content in breast milk has been reported to increase up to threefold within a feed with typical ranges between 2 and 6 wt %.<sup>17,18</sup> Studies by Khan et al.<sup>19,20</sup> that collected the foremilk and hindmilk (the beginning and end of a breastfeed) from human breastfeeding also observed a significant increase in fat content between samples collected from individual donors, but no statistically different change in either protein (casein, whey, and skim milk) or lactose content during a feed. Also, within a single day, the average fat composition of milk has been shown to vary significantly depending on infant feeding behavior, whereas protein and lactose contents remained stable. It is also important to note that significant variations in milk contents between individual infant-mother pairs may occur at the same stage postpartum.<sup>20</sup> Over the first 30 days of life, the average total protein and lactose content significantly decreases and fat content increases, after which time all three compositions remain relatively stable.<sup>21–24</sup>

### Suction Rate of Infant

Typical suction rates in breastfeeding upon the onset of nutritive sucking (i.e., significant flows of milk leaving the breast) have been reported to range typically between 40 and 120 suction pulses/min, although this can vary depending on the stage of the feed and infant.<sup>13,25,26</sup> A typical feed volume has been shown to be approximately 50–80 g ingested over 7–10 min.<sup>18,27,28</sup>

### Flow Rates of Milk from Breast

Flow rate also significantly changes depending on the infant and the phase of the feed. A previous review of breastfeeding behavior reports that volumes of milk intake can vary significantly between 0.01 and 0.14 mL/suction pulse, which when correlated against suction pulse rates of 40–120 pulses/min gives potential average flow rates of 0.4–16.8 mL/min.<sup>13</sup>

### Study Aims

The present proof of concept study investigated the effect of typically reported values of milk fat content and flow rate, and infant suction rate in breastfeeding upon the delivery of a model compound in a tablet placed inside a NSDS. This was performed using an apparatus that simulates the pressure conditions, average flow rate, fluid motion, and composition of milk as it leaves a nipple and passes through a NSDS.

## MATERIALS AND METHODS

### Adapting Nipple Shields to Contain Tablets

Nipple shield delivery system prototypes were made by adapting an existing commercial nipple shield to hold a tablet. A nipple shield (Maternity Silicone Nipple Shields, Boots, Cambridge, UK) had a 15-mm outer diameter O-ring (3.9 mm thick, 9.5 mm inner diameter) with a fiberglass mesh (1.4 mm square spacing with 0.4 mm fiber diameter) sealed inside the nipple shield using silicone (Platsil Gel 00, Mouldlife, Suffolk, UK) at 9 mm from the inside tip of the nipple. The mesh was placed on the side of the O-ring nearest to the inside of the nipple shield in order to allow a tablet to sit within the O-ring in the shield. This allowed tablets to be accurately positioned in the same location for experiments. The nipple shield had four evenly spaced 1 mm holes around the nipple to allow milk to pass out of the device. An additional eight evenly spaced holes of the same diameter to the existing holes were added 5 mm further down the nipple to increase the release of the disintegrated tablet from the device (see Fig. 1). Preliminary experiments indicated that without these additional holes a build up of fragmented tablet within the shield reservoir occurred.

### NSDS Tablets Used

Round-faced tablets (0.33 g, 8 mm diameter) were formulated by direct compression using a Manesty F3 tablet press (Manesty, Liverpool, UK) and a biconcave punch and die set (Holland, Nottingham, UK) with a crushing strength of 80 N. A dispersible formulation was used to maximize the likelihood of API delivery well within a typical breastfeed (up to ~80 g).<sup>18</sup> Sulforhodamine B (SB) (Sigma-Aldrich, Dorset, UK), a highly soluble red dye monosodium salt, was used as a model API. The dye was found to be accurately detected in milk using a spectroscopic assay without additional sample manipulation, with a peak absorbance at 554 nm. Tablet excipients used were based on typical pharmaceutical requirements for a fast disintegrating tablet using direct compression.<sup>29</sup> Tables 1 and 2 outline the composition, excipient role, and the results of standard European Pharmacopeia physical testing performed on the tablets.

### Simulation of Milk Flow from a Human Nipple

A silicone human nipple mimic (HNM) was constructed with ducts to simulate the flow of milk leaving a breast induced from an infant's suction. The silicone nipple shape was formed out of a polyurethane mold from epoxy modeling board (constructed using a computer-aided design high-pressure waterjet). This produced a hemisphere with a 12-mm diameter based on a typical size of a nipple.<sup>12</sup> A square grid of 25 equally spaced stainless steel needles held apart using a plastic mesh was also placed into the mold when the silicone (Platsil Gel 00; Mouldlife) was poured in. The needle number, size, and spacing were based on

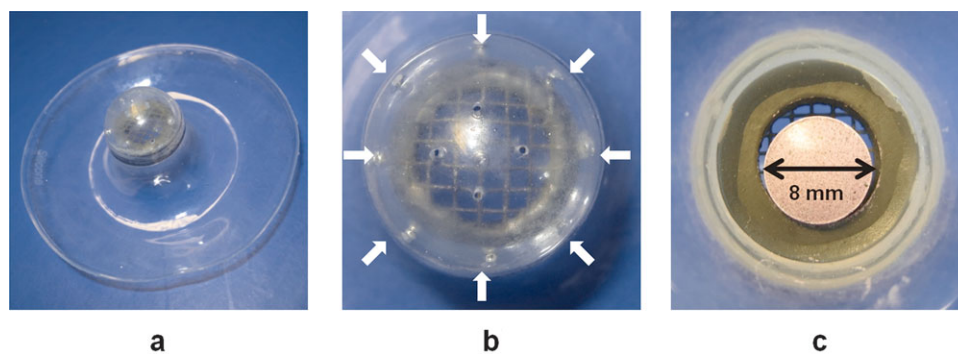

**Figure 1.** Nipple shield and tablet type used in experiments. (a) Modified nipple shield containing tablet holder O-ring. (b) Close up of modified nipple shield with additional holes added to promote milk and tablet release from shield reservoir (indicated by arrows). (c) Tablet positioned inside nipple shield O-ring holder.

**Table 1.** Formulation of Tablets Used in All Experiments

Chemical	Role	w/w	Grade	Manufacturer
Sulforhodamine B	Model compound	2.6	75% Purity	Sigma–Aldrich, Dorset, UK
Lactose (SuperTab® 14SD)	Filler	91.4	Ph. Eur	DFE Pharma, Goch, Germany
Sodium starch glycolate (Explotab® CLV)	Superdisintegrant	3.0	Typ (A) Ph. Eur	Mendell GmbH, Völklingen, Germany
Croscarmellose sodium (Ac-Di-Sol)	Superdisintegrant	2.0	Ph. Eur	FMC Biopolymer, Girvan, UK
Magnesium stearate	Lubricant	1.0	Technical grade	Sigma–Aldrich, Dorset, UK

**Table 2.** Physical Characteristics of Tablets Used in Experimentation (European Pharmacopeia Methods)

Mean Weight [(mg) ± SD]	Mean Crushing Strength [(N) ± SD]	Tensile Strength [(MPa) ± SD]	Friability [(%) ± SD]	Disintegration Time (Water at 37°C) [(min, s) ± SD (s)]
$n = 20$ 329 ± 1	$n = 5$ 76.8 ± 1.9	$n = 5$ 1.06 ± 0.03	$n = 20$ 0.3 ± 0.03	$n = 6$ 1 min 56 s ± 4.16

mimicking pore dimensions from previously reported analysis of dissected nipples.<sup>12</sup> After the silicone had set, the needles were carefully pushed through the outside of the nipple to create flow channels through it and then were removed leaving 25 evenly spaced pores passing through the HNM. The nipple was then attached using silicone to an oval silicone shape to allow the nipple shield to seal well around the nipple (see Fig. 2).

#### Human Milk Used in Experimentation

Anonymized human milk samples were obtained from approximately 20 healthy donors from the Queen Charlotte's and Chelsea Hospital Milk Bank (Imperial College Healthcare NHS Trust). The donors had all consented for their milk to be used for research as it was not able to be used for donation. They were screened for HIV 1 and 2, HTLV I and II, hepatitis B and

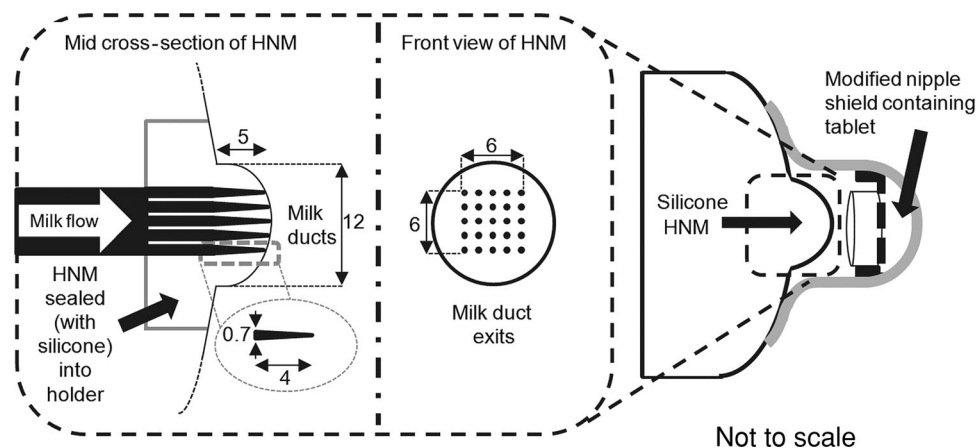

**Figure 2.** Diagram and dimensions of silicone human nipple mimic (HNM) and positioning relative to the nipple shield for release tests. (Right) Nipple shield with tablet positioned on the HNM. The HNM is sealed using silicone within an oval silicone shape to allow the nipple shield to seal well and maintain pressure conditions. (Left) Cross-section and front view of HNM with 25 evenly spaced ducts. All indicated measured lengths are in mm; diagram is not to scale.

C, and syphilis, and ethical approval for use was obtained from the University of Cambridge (Cambridge Human Biology Research Ethics Committee, University of Cambridge). Approximately 5 L of milk from 10 donors was pooled into a single composition, aliquoted into 50 mL centrifuge tubes and stored at  $-80^{\circ}\text{C}$ . The remaining milk from separate donors (also  $\sim 5$  L) was also pooled into a single composition, and then half was placed in 50 mL centrifuge tubes and centrifuged at 5411 g (5500 RPM) using a Sigma 3–16 PK centrifuge (Sigma-Zentrifugen, Osterode, Germany) for 15 min. A fat layer obtained at the top of the flask was then carefully removed using a curved face spatula, and the remaining milk was pooled into a single flask. After centrifugation, a small pellet ( $<0.25$  mL) was also observed at the bottom of the tubes (presumed to be predominantly protein) and using a pipette was resuspended in 5 mL of the fat-free milk and added to the main flask. This fat-free milk and the milk not centrifuged were then combined at different proportions to make up several mixtures with different fat compositions. Samples were then placed in 50 mL centrifuge tubes and stored at  $-80^{\circ}\text{C}$ .

The test milk samples were measured for total fat and protein content. Fat content was measured using a creatocrit method. Briefly, 1 mL samples were placed in 4.6 mm inner diameter 80 mm length transparent thick walled plastic tubes and centrifuged at 920 g using a Sigma 3–16 PK centrifuge (Sigma-Zentrifugen) for 15 min. Creatocrit is defined as the percentage of the upper fat length formed in centrifugation to the total length of the liquid in the tube. Using Wang et al.'s<sup>30</sup> correlation of creatocrit to fat content in human milk samples previously frozen the approximate fat content was estimated. Wang et al.'s<sup>30</sup> correlation is for samples stored and thawed from  $-20^{\circ}\text{C}$  rather than  $-80^{\circ}\text{C}$ , but is still thought to give a reasonable indication of content. Total protein content was determined using a standard Bradford Agent (Sigma-Aldrich) assay.<sup>31</sup> All measurements were performed in triplicate on triplicate samples and the average taken.

### Quantification of SB in Milk

The absorbances at 554 nm of 230  $\mu\text{L}$  calibration solutions of API mimic SB were measured in triplicate in flat-bottomed 96-well plates (Sterilin, Newport, UK) for each milk type using an EnVision 2104 Multilabel Platereader, (PerkinElmer, Cambridgeshire, UK). Lines of best fit using a power law were used for all fluids apart from the skimmed (fat free) milk where a polynomial fit was used.  $R^2$  values for all fits were at least of 0.99. Concentrations were found to be accurately detected between approximately  $1 \times 10^{-4}$  and 0.1 wt % for all fluids. Typically within 5% of all SB was accounted for in preliminary dissolution tests using human milk, indicating that the possible interference of tablet excipients upon SB detection was within acceptable limits for this proof of concept study.

### Experimental Apparatus Design and Operation

Release experiments were conducted using an apparatus outlined in Figure 3. The system operated by continuously stirred human milk in a reservoir (Supplementary Information, S1) being steadily pumped using a peristaltic pump (P1) (Masterflex model 7521–35; easy-load II model 77200–60; Cole-Palmer, London, UK) into the HNM. Prior to reaching the HNM, the milk was also heated (using a heat-exchanger HX1) so as to exit the HNM at  $37^{\circ}\text{C}$ . Attached to the HNM was the nipple shield

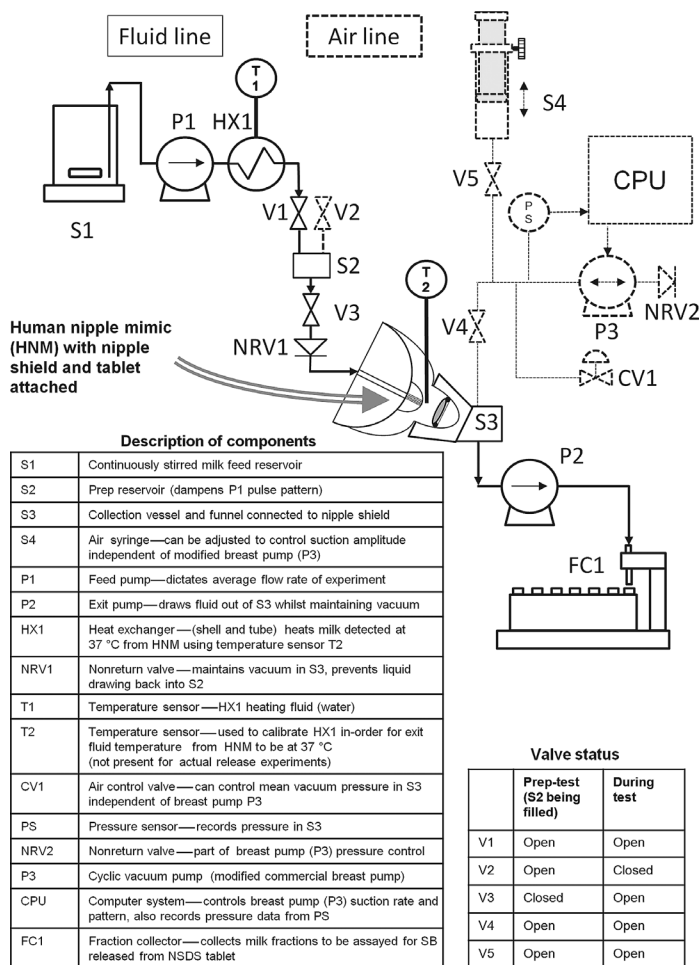

**Figure 3.** Nipple shield breastfeeding simulation apparatus and descriptions of apparatus components and valve status during apparatus operation.

containing the SB tablet. Milk was drawn out of the HNM using a vacuum pump (P3). It then passed through the nipple shield and tablet and now containing the disintegrated tablet fractions was pumped using a peristaltic pump (P2) (Masterflex model 7521–75, easy-load model 7518–10, Cole-Palmer) to a fraction collector (FC1) (SuperFrac<sup>TM</sup> fraction collector; GE Healthcare Sciences, Buckinghamshire, UK), and the collected fractions were assayed for SB content.

The HNM and nipple shield were securely held together using a customized clamp to ensure they were located in the same position for each experiment. They were also at the same angle for all experiments ( $30^{\circ}$  down from the vertical). The clamp ensured the system was airtight. The positioning of the nipple shield over the HNM allowed approximately a 1-mm gap between the tip of the HNM and the tablet. A silicone-sealed funnel (S3) on the outside of the nipple shield was connected via an air line to the vacuum pump (P3).

The vacuum pump induced a regular wave-like pressure cycle, which upon its increase in vacuum drew milk out of the HNM onto the tablet. During the release of suction pressure, no milk left the HNM (as previously reported in physiological environments),<sup>27</sup> and the feed pump (P1) continuously loaded the HNM with more milk to be drawn out of the nipple for the next suction cycle. The purpose of the feed pump was to dictate

the mean flow rate of fluid throughout experiments, whereas the vacuum pump controlled the withdrawal of milk from the HNM. Preliminary experiments demonstrated that without the feed pump (P1) the flow rate from the milk reservoir could not be accurately controlled (unpublished data).

Also attached to the lower part of the funnel (S3) connected to the nipple shield was a small reservoir that collected the fluid as it left the nipple shield. The reservoir had a pipe attached to its base that was connected to the peristaltic pump (P2), which drew the fluid out of the reservoir. It also maintained the vacuum within the system, effectively acting as a nonreturn valve. The fluid then passed to the fraction collector FC1 that collected fluid in approximately 1.0–1.5 mL fractions. Because the system was constantly under vacuum, preliminary testing using a nonreturn valve instead of the pump P2 did not allow fluid to be released out of the system without a significant build up of fluid behind the valve. The speed of P2 was adjusted to match the average flow rate of fluid entering the reservoir (dictated by P1) so as to not influence the vacuum pressure within the system.

The vacuum pump (P3) was a modified Medela swing electric breast pump (Medela, Manchester, UK). The pump's control circuitry was connected to a National Instruments (NI) controller (NI 9401 8 Ch; 5 V/TTL High-Speed Bidirectional Digital I/O Module; National Instruments, Austin, Texas) and controlled by a National Instruments 2011 Labview software (via a NI CompactDAQ 4-Slot USB Chassis) on a Microsoft Windows XP computer. This was used to control the suction rate, depth of suction, and pattern of suction of the pump with a much greater range of control than the pump's original manual controls. Pressure within the nipple shield was measured using a SSOB002A pressure gauge (PS) (Sensortech, Munich, Germany). The pressure readings were also displayed and logged using the Labview program via a National Instruments data acquisition unit (NI USB-6008 12-Bit, 10 kS/s Multifunction DAQ).

The pressure patterns induced could also be controlled by a manual needle control valve (CV1) (Swagelok, Hertfordshire, UK), which could change the mean pressure (i.e., what the pressure waves cycled around). By opening CV1, the mean vacuum pressure decreased closer to atmospheric pressure. Also a 50 mL syringe (S4) was connected to the air line system which could control the amplitude of the pressure waves induced—opening the syringe increased the air volume in the system and subsequently reduced the amplitude of the cyclic suction pulses.

The system allowed a constant vacuum to be held between suction cycles based on breastfeeding behavior,<sup>27</sup> which was not possible using the unmodified breast pump. Figure 4a compares typical pressure profiles induced by the unmodified breast pump and the modified pump (used in experiments) producing a suction profile typical of a breastfeeding infant.<sup>27</sup> For experiments, the pressure cycle was kept constant for the entire test in order to strengthen attribution of drug release behavior to a particular variable; however, in a physiological setting, the pressure profile of suction throughout is complex, with changes in amplitude, mean pressure, and suction rate.<sup>27,28,32</sup>

At the beginning of experiments, milk was drawn into a 20-mL reservoir (S2) where 3 mL was allowed to build up. This reservoir dampened the pulsed flow pattern induced by the feed pump (P1). The vacuum pump (P3) and exit reservoir pump (P2) were then turned on and the feed reservoir valve (V3) was opened. Fluid passed out of the feed reservoir through

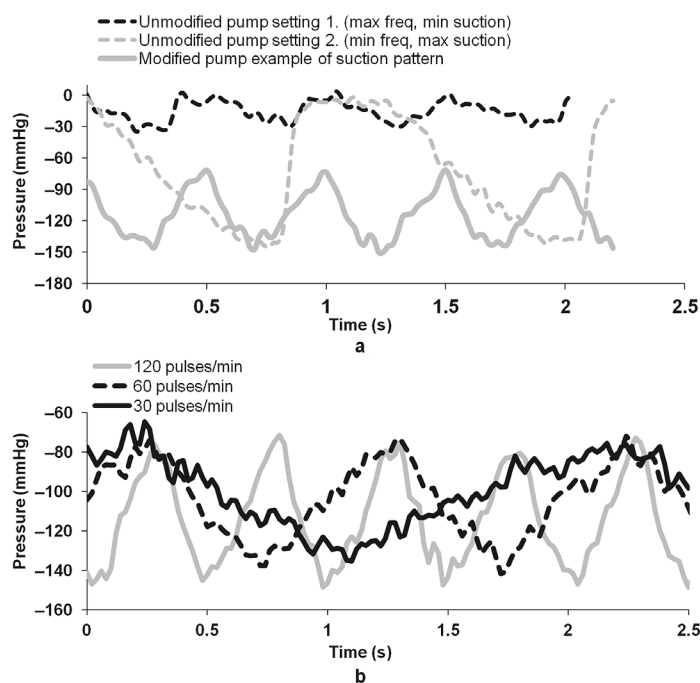

**Figure 4.** Pressure profiles produced within the breastfeeding simulation apparatus comparing: (a) two pressure profiles induced by an unmodified breast pump at limits of operation (setting 1: maximum frequency and minimum suction; setting 2: minimum frequency and maximum suction), and an example of the modified breast pump profile based on typical pressure profiles of a baby's suction during breastfeeding<sup>27</sup> and (b) examples of typical pressure profiles used in experiments for suction pulses of 30, 60, and 120 suction pulses/min.

a nonreturn valve into the HNM. The nonreturn valve prevented fluid being forced back into the feed reservoir during the increased pressure step of the vacuum pump cycle.

### Experiment Test Sets

Three experimental test sets were performed, each varying one factor known to change in breastfeeding while keeping all other conditions constant. These factors were pulse rate, flow rate, and milk fat content. Where one condition was varied, all other conditions were kept constant at previous typically reported physiological conditions.

Approximately 50 mL of human milk was used for each experiment and experiments were performed in triplicate. For pulse and flow rate experiments, the same pooled milk was used, whereas as previously discussed for fat content tests, separate pooled milk was used with the fat content varied by fat removal using centrifugation. Table 3 outlines the conditions used for all experiments.

Four different suction pulse rates of 120, 60, 30, and 0 pulses/min were investigated using an average flow rate of 5 mL/min. The same amplitude of suction was also used for all conditions. For 0 suction pulses/min, the feed pump (P1) dictated the flow profile leaving the HNM—this condition was used as a control to investigate the influence of pulsed behavior of fluid produced by P3 versus constant flow rate induced by P1 on SB release from the tablet. Figure 4b displays the typical pressure profiles induced in the nipple shield for suction pulse rates of 120, 60, and 30 suction pulses/min.

**Table 3.** Test Conditions for All Experiments

Figure Displaying Experiments and Data Symbols	Avg. Flow Rate (mL/min)	Pulse Rate (pulse/min)	Mean Pressure (mm Hg)	Average Amplitude (mm Hg)	Fluid Composition			
					Fat (%)	Creamatocrit (wt %) <sup>a</sup>	Protein (wt %)	
5	△	5	120	-105	35	5.5	3.4	2.1
	▲	5	60	-105	35	5.5	3.4	2.1
	□	5	30	-105	35	5.5	3.4	2.1
	◆	5	0	0	0	5.5	3.4	2.1
6	△	8	60	-105	35	5.5	3.4	2.1
	■	5	60	-105	35	5.5	3.4	2.1
	◆	1	60	-105	35	5.5	3.4	2.1
7	■	5	60	-105	35	7.1	4.2	1.7
	○	5	60	-105	35	4.6	2.9	1.7
	▲	5	60	-105	35	0.0	0.0	1.2

<sup>a</sup>Based on previously reported correlation of creatinocrit to fat content in human milk.<sup>30</sup>

For flow-rate experiments, three average flows of 1, 5, and 8 mL/min were used, while under a constant suction pulse rate of 60 pulses/min at constant amplitude and mean pressure.

For fat content experiments, three compositions were considered. One content reflecting a typical average fat content of milk (4.2 wt %), another reflecting a lower (2.9 wt %) content that is found in foremilk<sup>17,18</sup>, and finally one where the fat had been removed, which is not found in physiological circumstances but was used to gain further insight on the potential influence of fat in a breastfeed. For all fluids, the average flow rate was kept constant at 5 mL/min and suction pulse rate constant at 60 pulses/min with a constant amplitude and mean pressure.

## RESULTS

For all tests, milk was seen to fill the reservoir of the nipple shield before releasing in pulsed bursts into the collection reservoir (S3) in sync with the increasing vacuum phase induced by P3. After tests, thin patches of insoluble white solid were found adhered to the inside of the nipple shield, presumed to be tablet excipient. Soaking the nipple shield in 3.5 M sulfuric acid (Sigma–Aldrich) at 70°C for 3 h was found to remove this coating without causing degradation to the nipple shield.

Results are graphically presented as the average of triplicate tests for each test condition used, with error bars representing the standard error between repeat tests. Data points at 1.5 mL intervals are displayed on results graphs, which are the average of the linear interpolation between sample points for each test. Results were compared using a one-way ANOVA analysis (posttest: Newman–Keuls multiple comparison test, software: GraphPad Prism 5, GraphPad Software, Inc., La Jolla, California) with significance at (\*)  $p < 0.05$ , (\*\*)  $p < 0.01$ , and (\*\*\*)  $p < 0.001$ , indicated on the result graphs below the data points (Figs. 5, 6, 7). The experimental procedure described in this manuscript is an adapted dissolution test for a standard tablet formulation. ANOVA is commonly used in comparative analysis for such studies<sup>33</sup>, so was deemed acceptable for this work. Results are displayed as the average release of SB as a function of volume for: (1) wt % in collected fractions; and (2) the cumulative mass of SB relative to the initial amount of SB in the tablet.

### Varying Suction Pulse Rate

Figure 5 displays SB release for suction pulse rates of 120, 60, 30 pulses/min and constant flow (0 pulses/min) with the average flow rate for all four conditions at 5 mL/min. Before 18 mL, suction pulse rates of 30, 60, and 120 pulses/min produced similar release patterns, and after 24 mL, there was a trend of higher suction pulse rate correlating with higher average cumulative release. After 6 mL, posttest analysis demonstrated that a suction pulse rate of 0 pulses/min had a significantly lower cumulative release than all other conditions for the entire test. Suction pulse rate tests of 60 and 30 pulses/min were not significantly different from each other for the majority of testing for both cumulative release and individual wt % fractions.

### Varying Flow Rate

Figure 6 displays SB release for flow rates of 1, 5, and 8 mL/min at a constant suction pulse rate of 60 pulses/min. Pulse amplitude and average vacuum pressure were also kept the same for all flow rates. At the flow rate of 8 mL/min, data were only available for the three repeat tests up to 40 mL. There were no clear trends in release concentration or cumulative release among the three flow rates. After 3 mL, there was no significant difference in cumulative release between 1 and 8 mL/min. Also, after 22.5 mL, the average wt % of release from 1 mL/min was approximately an order of magnitude lower than the two other tests.

### Varying Fat Content

Figure 7 displays SB release for three milk fluids with fat contents of 0.0, 2.9, and 4.2 wt % at a constant suction pulse rate of 60 pulses/min and constant flow rate of 5 mL/min. Pulse amplitude and average vacuum pressure were also kept the same for all flow rates. For 2.9 and 4.2 wt % fat fluids, there was no statistical difference in either release concentrations or cumulative release for the entire test. These two fluids also had the same total protein content (1.7 wt %), suggesting that SB release rate may not be influenced between these two fat compositions for the same protein content. At 0.0 wt % fat, a higher release concentration in collected fractions was seen until the majority of tablet had released (with posttest significance between 0 and 12 mL and 27 and 34.5 mL). Zero wt % fat also

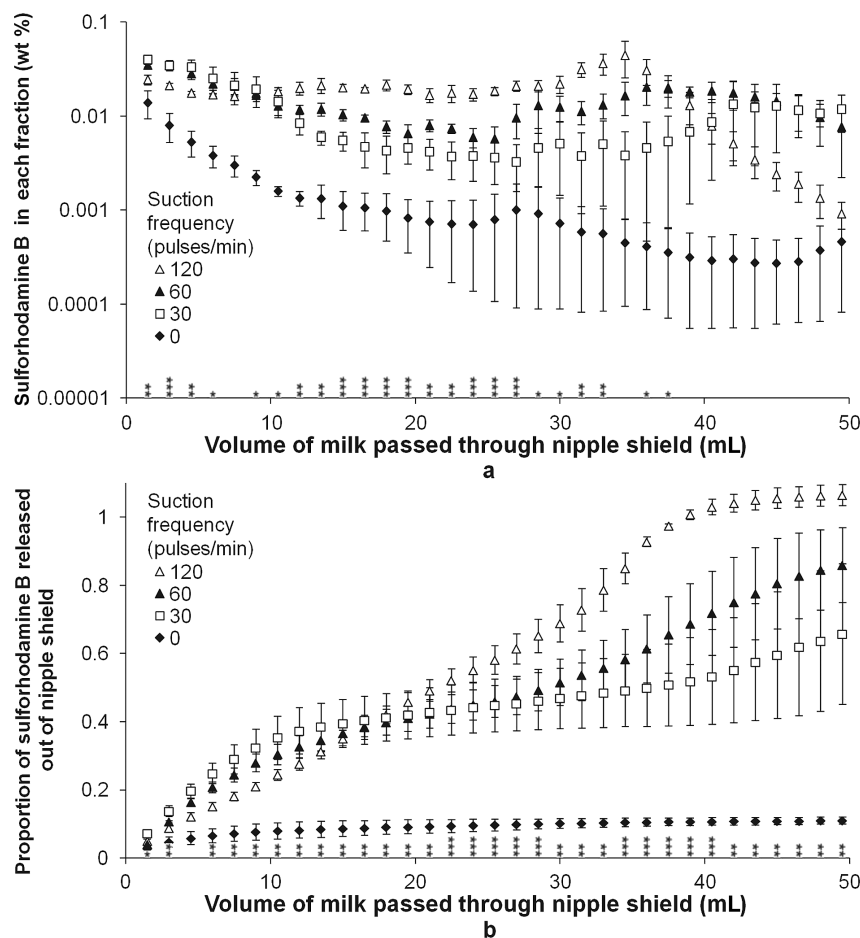

**Figure 5.** Effect of suction pulse rate on sulforhodamine B (SB) release. The effect of suction pulse rates of 120, 60, 30, and 0 (uniform flow) pulses/min at a constant flow rate of 5 mL/min on SB release into human milk is compared. Data are displayed as the average for three repeat tests of: (a) SB concentration in collected fractions and (b) cumulative SB release relative to amount in NSDS tablet. ANOVA analysis was performed between the test conditions with significance at (\*)  $p < 0.05$ , (\*\*)  $p < 0.01$ , and (\*\*\*)  $p < 0.001$  indicated above the horizontal axis. Error bars represent the standard error between repeat tests.

had a lower total protein content of 1.2 wt % as compared with 1.7 wt %. It is possible that a combination of both lower fat and protein contents contributed to increased SB release rate.

## DISCUSSION

### Variation in Suction Pulse Rate

For these experiments, the same pressure cycle was maintained throughout the experiments apart from 0 suction pulses/min where the system was run at atmospheric pressure. The fact that a suction pulse rate of 0 pulses/mL produced a significantly lower release of SB than all other conditions provided clear evidence that the vacuum pump's (P3) cyclic action was the major factor dictating SB release rather than the feed pump (P1) controlling the same average flow rate for each pulse condition.

As discussed, in breastfeeding the infant has nonregular suction pattern behavior in a typical feed.<sup>27,28,32</sup> For this study, in order to more accurately determine the effect of a single variable (the suction pulse rate), this more complex behavior was not mimicked. It allowed the identification of higher pulse rates appearing to correlate with increased cumulative release of SB.

The degree of variation in repeat tests suggests that a complex interaction between the milk and the tablet may occur, with small changes in tablet positioning potentially influencing release characteristics.

### Varying Flow Rate

There were no clear trends in release characteristics to flow rate, possibly because of competing factors controlling the tablet disintegration and dissolution rates at different flow rates. All three flow conditions had released at least 60% of SB after 40 mL of milk. Upon inspection after the 1 mL/min tests, a large amount of tablet was seen to be residing in the upper half of the holder (stuck to the mesh). This indicated that channels of fluid were likely passing predominantly below the tablet creating a relatively slow release rate.

### Varying Fat Content

The two fluids used to mimic breast milk (2.9 and 4.2 wt % fat) in this set of experiments had statistically insignificant differences in release patterns. This result suggests that the reported variation in fat content during a typical breastfeed may

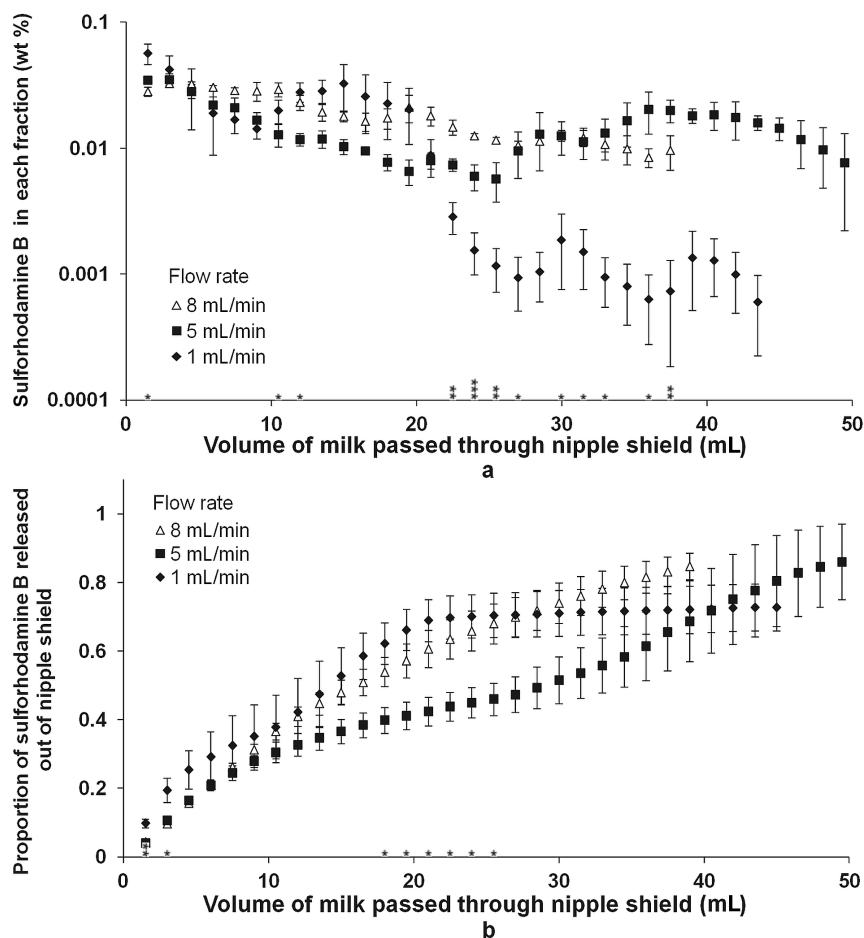

**Figure 6.** Effect of flow rate on sulforhodamine B (SB) release. The effect of flow rates of 1, 5, and 8 mL/min at a constant suction pulse rate of 60 pulses/min on SB release into human milk is compared. Data are displayed as the average for three repeat tests of: (a) SB concentration in collected fractions and (b) cumulative SB release relative to amount in NSDS tablet. ANOVA analysis was performed between the test conditions with significance at (\*)  $p < 0.05$ , (\*\*)  $p < 0.01$ , and (\*\*\*)  $p < 0.001$  indicated above the horizontal axis. Error bars represent the standard error between repeat tests.

not have a large influence upon tablet release properties.<sup>17,18</sup> Also, as discussed, the average fat, protein, and lactose content in feeds vary significantly within the first 30 days of life,<sup>21,24</sup> and so fast release formulations will be needed to cater for this variation of milk compositions.

### Mimicking Infant Behavior During Lactation

For this study, the action of lactation induced by the vacuum created by the infant was the sole consideration. The infant's tongue also plays a role in inducing the breastfeeding process, with recent evidence suggesting its influence upon lactation may be most prominent during the initial stages of inducing lactation rather than during the actual breastfeed.<sup>27,34–36</sup>

### Tablet Holder Considerations Within Nipple Shield

The design of a clinical NSDS to contain a tablet would likely have it secured in place. Initial prototypes for this study used a cross-hair holder to position the tablet within the center of the nipple shield. However, it was found that milk channeled around the tablet and less than 50 wt % would typically be released when 100 mL of fluid passed through the device. On the basis of this observation, a holder that allowed the tablet to

drop to the lowest point in any orientation in the holder is most likely an effective manner of maximizing wettability of tablet surface by milk in device use, increasing the likelihood of API delivery.

### Tablet Formulation

Cumulative release of SB for most test conditions did not reach 80% within 40 mL. Depending on the therapeutic ingredient to be delivered, formulations will need to be designed to ensure that at least the minimum acceptable dose is delivered within the majority of breastfeeds, which have been reported to last for approximately 80 g, but with high variation.<sup>18</sup> The amount of intended uses of the device per day will also have to be significantly lower than the amount of feeds to ensure that the minimum required dose is always met. A study of 71 breastfeeding infants of 1–6 months found they feed on average 11 times a day. However, there are highly variable feeding lengths and intervals dependent on the infant and the mother.<sup>18,35</sup> Because of this variability, the NSDS may be best suited for single daily administration of substances that can have a relatively wide range of acceptable doses, such as potentially probiotics.<sup>37</sup> The basis of the formulation method and composition used in this study may need to be revised to ensure faster delivery



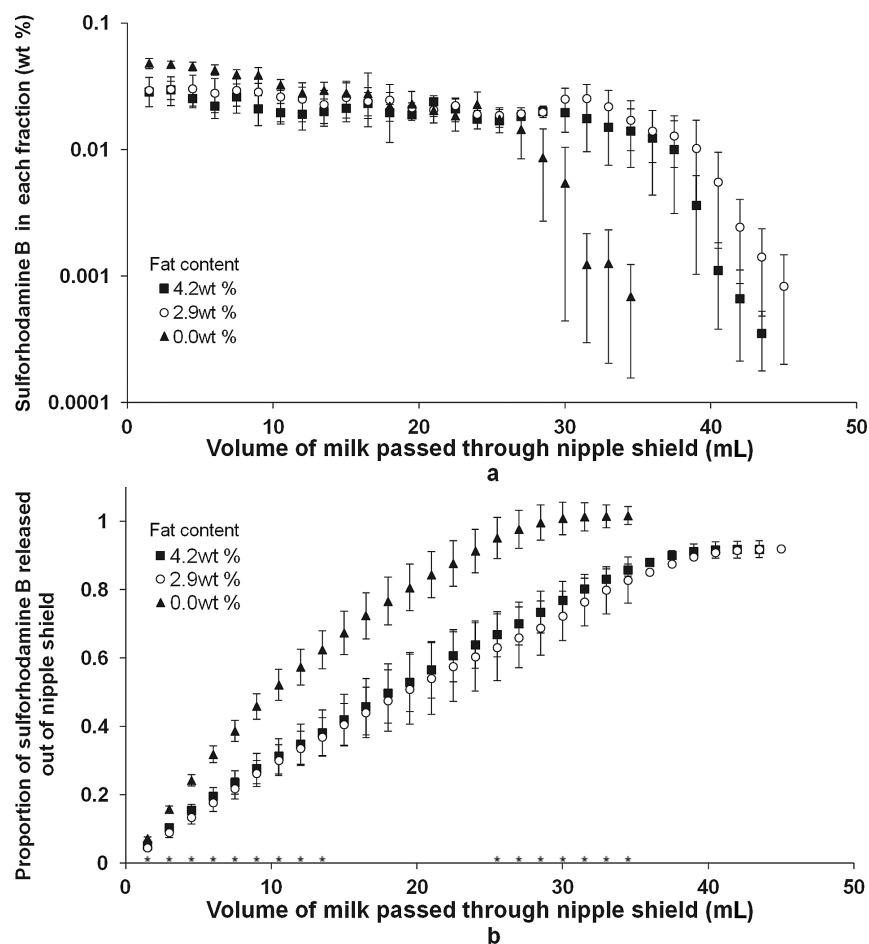

**Figure 7.** Effect of fat content on sulforhodamine B (SB) release. The effect of fluid compositions of 4.2, 2.9, and 0 wt % fat human milk at a constant suction pulse rate of 60 pulses/min and flow rate of 5 mL/min is on SB release into the milk is compared. Data are displayed as the average for three repeat tests of: (a) SB concentration in collected fractions and (b) cumulative SB release relative to amount in NSDS tablet. ANOVA analysis was performed between the test conditions with significance at (\*)  $p < 0.05$ , (\*\*)  $p < 0.01$ , and (\*\*\*)  $p < 0.001$  indicated above the horizontal axis. Error bars represent the standard error between repeat tests.

for clinical settings, although release rates may increase as the full physiological process of breastfeeding using a NSDS is mimicked in future studies. For example, during nipple shield use, the tongue is likely to press against the underside of the nipple shield, and depending on how the tablet is built into the shield, this may promote tablet disintegration and delivery to the infant.

Also, rather than using SB as a model compound, the use of actual APIs with different physicochemical properties may lead to different release characteristics for the otherwise same formulation. Appropriate formulation development strategies will be selected considering the physicochemical properties of drugs (e.g., solubility) and intended drug release mechanism to ensure the optimum use of the NSDS.

The similar release characteristics observed for different fat contents (with constant protein content) may be specific to this formulation and the milk composition used. Interestingly, previous tablet disintegration studies in relevant media have reported that protein films coating tablets can slow disintegration times, suggesting that differing protein contents in milk may influence tablet disintegration in a NSDS.<sup>38</sup>

## CONCLUSIONS

This proof of concept study identified physiological behaviors within breastfeeding that could influence API release from a NSDS. It was achieved using an apparatus designed to mimic lactation from a human nipple induced purely by infant suction. The NSDS would be used by mothers to deliver drugs and nutrients to her infant during breastfeeding, with its use potentially circumventing many problems that arise in current methods of infant drug delivery, particularly in developing countries. The simulation apparatus could be further developed to incorporate the action of a breastfeeding infant's tongue, to allow identification of its influence on API release characteristics from a NSDS. Using the lactation apparatus with a NSDS containing a tablet, it was found that increased infant suction pulse rate (for constant fluid content and constant average flow rate) correlated with increased cumulative release into milk of a model compound contained within the tablet. Results also suggested that the changing fat content during a breastfeed would not significantly influence API release from the tablet for constant suction conditions of an infant. These are essential findings for use in optimizing relevant factors in NSDS tablet design,

to ensure consistent and reproducible drug release within a certain volume of a breastfeed.

## ACKNOWLEDGMENTS

We are grateful to the Bill and Melinda Gates Foundation (Grand Challenges Exploration Initiative), the Clinton Foundation (Clinton Global Initiative University), the UK EPSRC, King's College (University of Cambridge), and the International Development Design Summit for financial support and advice. At the University of Cambridge, we are grateful to Lee Pratt, Andy Hubbard, Gary Chapman, John Gannon, Wei-Yao Ma, Chris Rutt, David McNally, Fergus Kulasinghe, and Robert Courtney from the Department of Chemical Engineering and Biotechnology and Alistair Ross from the Department of Engineering, also Neil D'Souza-Mathew from TTP (The Technology Partnership, UK), Hannah Wade from National Instruments UK, Sunita Sridhar, Aspen Flynn, and Geoff Galgon from JustMilk.org and Arron Rodrigues from EWH Cambridge who all provided technical advice and helped in the construction of the breastfeeding simulation rig. We also thank Prof. Alan Tunnacliffe and Dr. David Chau at the Department of Chemical Engineering and Biotechnology, University of Cambridge for advice and use of laboratory facilities. We thank Gillian Weaver, manager of the Queen Charlotte's and Chelsea Hospital Milk Bank (Imperial College Healthcare NHS Trust) for coordinating use of human milk samples. Stephen Gerrard is an inventor of the nipple shield delivery system (US patent 8357117 B2 and patent pending PCT/US10/44589, see <http://justmilk.org>).

## REFERENCES

- Kearns GL, Abdel-Rahman SM, Alander SW, Blowey DL, Leeder JS, Kauffman RE. 2003. Developmental pharmacology-drug disposition, action, and therapy in infants and children. *N Engl J Med* 349(12):1157–1167.
- Knoppert DC. 2009. Pediatric formulations: International issues and potential solutions. *Paediatr Drugs* 11(1):55–56.
- WHO. 2012. Priority live-saving medicines for women and children 2012. Accessed June 7, 2013, at: <http://apps.who.int/medicinedocs/documents/s19290en/s19290en.pdf>.
- UNICEF, WHO. 2010. Sources and prices of selected medicines for children. Including therapeutic food, dietary vitamin and mineral supplementation. 2nd ed. Accessed June 7, 2013, at: [http://www.unicef.org/supply/files/SOURCES\\_AND\\_PRICES\\_2010\(2\).pdf](http://www.unicef.org/supply/files/SOURCES_AND_PRICES_2010(2).pdf).
- WHO. 2007. Promoting safety of medicines for children. Accessed June 7, 2013, at: [http://www.who.int/medicines/publications/essentialmedicines/Promotion\\_safe\\_med\\_childrens.pdf](http://www.who.int/medicines/publications/essentialmedicines/Promotion_safe_med_childrens.pdf).
- Beggs S, Cranswick N, Reed M. 2005. Improving drug use for children in the developing world. *Arch Dis Child* 90(10):1091–1093.
- Pandolfini C, Bonati M. 2005. A literature review on off-label drug use in children. *Eur J Pediatr* 164(9):552–558.
- Stoltenberg I, Winzenburg G, Breikreutz J. 2010. Solid oral dosage forms for children—Formulations, excipients and acceptance issues. *J Appl Ther Res* 7:141–146.
- Sokal D, Gerrard S, Kneen E, Hubbard R, Galgon G, Banda T. 2009. Device and method for delivering an agent into breast milk while breastfeeding. Patent US8357117 B2.
- Gerrard SE, Baniecki ML, Sokal DC, Morris MK, Urdaneta-Hartmann S, Krebs FC, Wigdahl B, Abrams BF, Hanson CV, Slater NK, Edwards AD. 2012. A nipple shield delivery system for oral drug delivery to breastfeeding infants: Microbicide delivery to inactivate HIV. *Int J Pharm* 434(1–2):224–234.
- Gerrard SE, Larson AM, Klibanov AM, Slater NK, Hanson CV, Abrams BF, Morris MK. 2013. Reducing infectivity of HIV upon exposure to surfaces coated with N,N-dodecyl, methyl-polyethylenimine. *Biotechnol Bioeng* 110(7):2058–2062.
- Rusby JE, Brachtel EF, Michaelson JS, Koerner FC, Smith BL. 2007. Breast duct anatomy in the human nipple: Three-dimensional patterns and clinical implications. *Breast Cancer Res Treat* 106(2):171–179.
- Zoppou C, Barry SI, Mercer GN. 1997. Dynamics of human milk extraction: A comparative study of breast feeding and breast pumping. *Bull Math Biol* 59(5):953–973.
- Emmett PM, Rogers IS. 1997. Properties of human milk and their relationship with maternal nutrition. *Early Hum Dev* 49:S7–S28.
- Riordan J. 2005. Breastfeeding and human lactation. 3rd ed. Burlington, Vermont: Jones & Bartlett Publishers, pp 103–110.
- Goedhart AC, Bindels JG. 1994. The composition of human milk as a model for the design of infant formulas: Recent findings and possible applications. *Nutr Res Rev* 7:1–24.
- Daly SEJ, Dirosso A, Owens RA, Hartmann PE. 1993. Degree of breast emptying explains changes in the fat-content, but not fatty-acid composition, of human-milk. *Exp Physiol* 78(6):741–755.
- Kent JC, Mitoulas LR, Cregan MD, Ramsay DT, Doherty DA, Hartmann PE. 2006. Volume and frequency of breastfeedings and fat content of breast milk throughout the day. *Pediatrics* 117(3):e387–e395.
- Khan S, Casadio YS, Lai CT, Prime DK, Hepworth AR, Trengove NJ, Hartmann PE. 2012. Investigation of short-term variations in casein and whey proteins in breast milk of term mothers. *J Pediatr Gastroenterol Nutr* 55(2):136–141.
- Khan S, Hepworth AR, Prime DK, Lai CT, Trengove NJ, Hartmann PE. 2013. Variation in fat, lactose, and protein composition in breast milk over 24 hours: Associations with infant feeding patterns. *J Hum Lact* 29(1):81–89.
- Hartmann PE, Prosser CG. 1984. Physiological basis of longitudinal changes in human milk yield and composition. *Fed Proc* 43(9):2448–2453.
- Nommsen LA, Lovelady CA, Heinig MJ, Lönnerdal B, Dewey KG. 1991. Determinants of energy, protein, lipid, and lactose concentrations in human milk during the first 12 mo of lactation: The DARLING Study. *Am J Clin Nutr* 53(2):457–465.
- Dewey KG, Lönnerdal B. 1983. Milk and nutrient intake of breastfed infants from 1 to 6 months: Relation to growth and fatness. *J Pediatr Gastroenterol Nutr* 2(3):497–506.
- Saarela T, Kokkonen J, Koivisto M. 2005. Macronutrient and energy contents of human milk fractions during the first six months of lactation. *Acta Paediatr* 94(9):1176–1181.
- Kent JC, Ramsay DT, Doherty D, Larsson M, Hartmann PE. 2003. Response of breasts to different stimulation patterns of an electric breast pump. *J Hum Lact* 19(2):179–186.
- Weber F, Woolridge MW, Baum JD. 1986. An ultrasonographic study of the organisation of sucking and swallowing by newborn infants. *Dev Med Child Neurol* 28(1):19–24.
- Geddes DT, Kent JC, Mitoulas LR, Hartmann PE. 2008. Tongue movement and intra-oral vacuum in breastfeeding infants. *Early Hum Dev* 84(7):471–477.
- Prieto CR, Cardenas H, Salvatierra AM, Boza C, Montes CG, Croxatto HB. 1996. Sucking pressure and its relationship to milk transfer during breastfeeding in humans. *J Reprod Fertil* 108(1):69–74.
- Charoo NA, Shamsher AA, Zidan AS, Rahman Z. 2012. Quality by design approach for formulation development: A case study of dispersible tablets. *Int J Pharm* 423(2):167–178.
- Wang CD, Chu PS, Mellen BG, Shenai JP. 1999. Creatatocrit and the nutrient composition of human milk. *J Perinatol* 19(5):343–346.
- Bradford MM. 1976. A rapid and sensitive method for the quantitation of microgram quantities of protein utilizing the principle of protein-dye binding. *Anal Biochem* 72(1):248–254.

- 32.** Woolridge MW. 1986. The “anatomy” of infant sucking. *Midwifery* 2(4):164–171.
- 33.** Costa P, Sousa Lobo JM. 2001. Modeling and comparison of dissolution profiles. *Eur J Pharm Sci* 13(2):123–133.
- 34.** Kent JC, Mitoulas LR, Cregan MD, Geddes DT, Larsson M, Doherty DA, Hartmann PE. 2008. Importance of vacuum for breast-milk expression. *Breastfeed Med* 3(1):11–19.
- 35.** Kent JC. 2007. How breastfeeding works. *J Midwifery Womens Health* 52(6):564–570.
- 36.** Monaci G, Woolridge M. 2011. Ultrasound video analysis for understanding infant breastfeeding. In *ICIP 2011: IEEE International Conference on Image Processing*; Brussels, Belgium; September 11–14, 2011; 1765–1768.
- 37.** Boyle RJ, Robins-Browne RM, Tang ML. 2006. Probiotic use in clinical practice: What are the risks? *Am J Clin Nutr* 83(6):1256–1264.
- 38.** Abrahamsson B, Albery T, Eriksson A, Gustafsson I, Sjoberg M. 2004. Food effects on tablet disintegration. *Eur J Pharm Sci* 22(2–3):165–172.