

Calming Children When Drawing Blood Using Breath-based Biofeedback

1st Author Name
Affiliation
City, Country
e-mail address

2nd Author Name
Affiliation
City, Country
e-mail address

3rd Author Name
Affiliation
City, Country
e-mail address

ABSTRACT

Blood sampling is a common and necessary procedure in the treatment and diagnosis of a variety of diseases. However, it often results in painful and stressful experiences for children. Designed together with domain experts, Pufferfish is a breath-controlled biofeedback game technology with bespoke airflow sensor that aims to calm children during blood sampling procedures. An initial randomized controlled trial was conducted in which 20 children aged 6-11 were assigned to one of two conditions involving either passive distraction (watching a video) or active distraction using the Pufferfish prototype. Medical staff rated Pufferfish significantly more useful in facilitating the blood sampling procedure compared to passive distraction. Qualitative feedback from patients, parents, and medical staff identified aspects that impact the acceptance of breath-based active distraction. Our study highlights the potential of non-pharmacological assistive technology tools to reduce fear and pain for children undergoing painful or stressful medical treatment.

Author Keywords

Children, assistive technology, hospital context, medical, blood drawing, blood test, biofeedback, game, calming, relax, field study, tangible computing, RCT, in the wild.

ACM Classification Keywords

H.5.m. Information interfaces and presentation (e.g., HCI):

INTRODUCTION

Blood sampling is among the most common medical procedures, and is often associated with anxiety, fear, worries, and even physical resistance from children. Medical staff can employ pharmacological techniques such as local anesthetic gel to reduce pain at the site of skin puncture, or increasingly invasive measures including physical restraint or sedation [26]. Non-pharmacological treatments have been explored as they reduce resources

Paste the appropriate copyright/license statement here. ACM now supports three different publication options:

- ACM copyright: ACM holds the copyright on the work. This is the historical approach.
- License: The author(s) retain copyright, but ACM receives an exclusive publication license.
- Open Access: The author(s) wish to pay for the work to be open access. The additional fee must be paid to ACM.

This text field is large enough to hold the appropriate release statement assuming it is single-spaced in Times New Roman 8-point font. Please do not change or modify the size of this text box.

Each submission will be assigned a DOI string to be included here.



Figure 1: The breath-controlled biofeedback game Pufferfish is used during blood drawing procedures to distract and calm down children and their parents. (Adult is depicted here as ethical review board did not permit photos of the children)

required from the medical staff, are usually simple to implement and do not carry the potential health risks of sedation [10]. These include reduction of pain through the application of cold compress at the injection site, emotional comfort through human touch, vibrotactile stimulation [5] or massage. Distraction is also a frequently used cognitive coping strategy that is intended to redirect the attention of the child toward a stimulus or engage the child actively in a task other than the procedure in order to diminishing the capacity to attend to painful stimuli, resulting in reduction of pain, distress, and anxiety [13]. While the function of distraction is not completely understood there is mounting evidence that it can improve the patient experience during painful procedures. Research has explored the use of passive distraction techniques, e.g. where the child is presented with music or a video during the procedure with successful results; or active distractions, e.g. asking the child to play an interactive game [34] or more physical tasks such as blowing soap bubbles [44]. Breathing tasks have gained attention because the activity itself could calm the child and stabilize the quick shallow breathing often associated with anxiety. Research has examined breathing exercises [15], which seem to assist in calming the child and muscle relaxation, making it easier and less painful to use the needle to take the blood sample.

While techniques of active or passive distraction have been shown to be beneficial for children, medical researchers

have claimed that not all work well in every situation and that caregivers should therefore have various techniques and strategies available for each patient [49]. Considering the fast-paced hospitals and the need for sanitary controls, attractive options would be simple, cheap and easy to use.

In this paper, we present a study that compares breath-based biofeedback and videogame technology for active distraction to reduce anxiety and pain during medical pediatric procedures. We present a bespoke airflow sensor suitable for use in a medical context. Based on an initial Randomized Controlled Trial (RCT) study in a hospital context we provide insights into how active and passive distraction techniques impact the blood draw procedure.

BACKGROUND AND RELATED WORK

There are broadly three categories of research that inform our work: pediatric health technologies, stress-relieving biofeedback applications, and medical studies of various distraction strategies within the pediatric health domain.

Existing Technologies for the Pediatric Health Domain

Designing hospital technologies is not new within HCI [4,45], and several technologies for pediatric health have also been presented [6,21,31,37,48]. However, most studies have either been early stage feasibility studies conducted in controlled lab settings [1,28,48] and/or have focused on other pediatric health contexts than blood drawing e.g., rehabilitation [31] or burn injuries [32,37]

The work most related to ours includes mediPuppet [28] and MEDi [1,6,7]. mediPuppet is an interactive and comforting companion that aims to help children to feel more relaxed and comfortable during medical procedures [28]. It is a tangible prototype comprising an Android smartphone embedded into a ‘puppet’ made of foam board, which allows the child to interact with a ‘procedure game map’ by scanning QR codes [28]. mediPuppet was evaluated in a lab study, and preliminary findings suggest that the participating children (aged three to five) treated the puppet as a real person that they became attached to [28].

More related to our work is MEDi [1,6,7] a humanoid robot that utilize cognitive behavioral strategies to mitigate pain and distress of children during their annual flu vaccination [1,7]. During the vaccination procedure, MEDi sat on a table in front of the child and several times asked the child to perform certain actions like e.g., blowing ‘dust’ off toy objects in front of the robot. The use of pre-programmed distraction strategies was associated with significantly less pain and distress in both children and parents.

Various Uses of Calming Biofeedback Applications

Research on stress reducing biofeedback applications have shown promising results in reducing stress in both adults and adolescents [19,29,35,36,38]. However, within the HCI community the use of biofeedback to distract or calm down users in a hospital setting has received less attention. As we highlight later in this paper, designing for and conducting evaluations in a hospital context requires interventions to be

sterile and in most cases there is not time for a patients to put on the special equipment required to detect breath or respiration in many of the existing stress relieving biofeedback applications [19,29,36,38].

Distraction Strategies used in Pediatric Health Care

Distraction is one of the most widely used non-pharmacological pain management techniques during medical procedures because it can be a simple and fast way to reduce pain, stress, and anxiety [24]. Blood sampling procedures are often performed with little pain and in many cases completed quickly, however, during the procedure, the medical staff orchestrates a very complex situation managing the behavior of the child and parents while at the same time manipulating the medical equipment needed to draw the blood. Various challenges arise as the medical technician finds a suitable vein through sight or palpation, potentially seeks additional vein punctures to attain proper flow, changes sample vials and removes the needle when complete. The child may disturb the process by moving or resisting physically. Coping strategies for children dealing with medical procedures such as venipuncture vary—some children prefer to watch the process while others prefer avoidance strategies, with cognitive distraction being the most widely adopted approach [39]. Many of the commonly used distraction techniques in pediatric care require either active or passive involvement [25]. Passive distraction techniques associated with reduced pain include watching an animation clip [51], listening to music or watching television [14]. In active distraction, the patient is engaged in a task that requires action in the form of physical activity or frequent responses to stimuli. Examples range from special cards that medical staff can use to prompt answers from patients [41], playing a console game or active participation with a digital companion [33].

Breathing tasks of various types have been explored as active distraction techniques. Results suggest reduced anxiety and pain during medical treatments. Manne et al. reported that inflating a balloon was an effective method in reducing the family’s and the child’s stress [30]. Gupta et al. showed that children’s pain levels were significantly lower in a balloon inflation group than in the control group [18]. French et al. taught children to blow out during immunizations as if blowing bubbles, resulting in significantly reduced levels of pain behaviors [15]. In another study using party blowers, Blount et al. found that the use of the breath based distraction was helpful for children coping with the pain of immunization [8]. In their study, a 10-12 minute training session with parents and children was required to prepare the children for exhaling during the needle insertion.

Existing HCI research has shown positive results in utilizing distraction techniques as a way to reduce anxiety and pain for children in hospital. Researchers within the HCI and medical domains have shown that breathing techniques and biofeedback are able to reduce stress and

anxiety. However, investigations have been carried out in controlled lab studies or outside the hospital context. In this paper, we extend this related work by investigating the potential benefits of distractions that combine breath-based relaxation therapy and engaging digital games for children who undergo stressful blood draw procedures.

DESIGN PROCESS - DESIGNING TECHNOLOGIES FOR THE HOSPITAL CONTEXT

In this section we present our design process. We used a contextual inquiry [20] inspired approach to understand the hospital context we were designing for, gather specifications for the Pufferfish prototype, and identify requirements needed to conduct evaluations in a hospital.

During the initial design process, we spent three days at a hospital pediatric phlebotomy department. We observed numerous blood tests of children of all ages and conducted interviews with Medical Laboratory Technologists (MLT), specialized professionals who take the blood samples, focusing on understanding their work practices, current strategies for calming children, and the challenges and opportunities for using and evaluating technological interventions in the pediatric phlebotomy department. In this early phase of the study, we interviewed two MLTs, the head of the pediatric phlebotomy department and one hospital clown whose role is to engage with children and raise their spirits. In addition, we also interviewed and observed several children and their parents, focusing on their expectations and experiences before (in the patient waiting room), during, and after the blood draw procedure. In the later part of the design process we had several meetings and interactions with an infection control nurse, who had to approve our prototypes and our (hygienic) procedures for handling the evaluation of Pufferfish. As part of this approval, we received training and detailed instructions on how to assemble and handle the Pufferfish prototypes and proper handling and interactions during the blood draw procedure with the children.

Below, we highlight two findings from our design process that we found especially relevant when designing technologies to be used during blood drawing procedures in a hospital context.

Designing Distractions for both Children and Parents

From analysis of our findings from our design process at the hospital, we learned that the MLTs frequently used distractions. These distractions were mostly verbal, like e.g., asking the child about hobbies, sports, or siblings, and had the purpose of calming the child and distracting them from the blood drawing. However, in our discussions with MLTs and a hospital clown, all emphasized that it was important not to introduce any technology that would fully immerse the child (e.g., virtual reality) during the blood drawing procedure, as the needle prick could then come as a shock. This could be very an unpleasant experience and could cause the child to abruptly (re)move her arm, which could result in a needle accident.

In addition, many of the MLTs commented that parents often failed to distract and calm their child during blood drawing. In fact, parents often made that their child more nervous, as they themselves were nervous and unable to hide it from their children. We observed numerous situations that supported this. For example, we often observed that parents were holding their child's hand, and though the child were told to look away, the parent was looking at the needle, and squeezed the child's hand harder and harder as the needle came closer to the arm, causing the child to "feel" the forthcoming pain, and thus become nervous. Thus, technologies for blood drawing procedures should be engaging and able to distract both the child and the child's parent(s) during blood drawing procedures.

Ensuring Hygienic and Sterile Handling of Technology

Without a doubt, the most challenging and time consuming task in this project was designing Pufferfish to pass the hospital's hygiene requirements, especially because our target patient group includes children who might suffer from various health issues or receiving medical treatments, which could negatively impact their immune systems.

From our meetings with the infection control nurse we learned that objects used as part of a hospital procedure should either be disposable (single use items) or able to be sterilized after use. We therefore had to explore options for sensing breath that would meet the requirements described in the next section. The final solution involved a contactless breath detecting silicone module that could be sterilized after each patient. All electronics are shielded from contact and therefore could be reused without the risk of transferring infection. Although 3D printing a controller was an option, the surface would need to be smooth enough to be cleaned with an antibacterial wipe as required by the infection control nurse. The use of LEGO bricks in the tangible Pufferfish controller presented smooth surfaces, but due to the separate pieces these could not be easily cleaned after use. An option suggested by the infection control nurse would be to completely disassemble and wash all parts in a special medical autoclave machine, which uses high temperature and pressure to sterilize instruments. We were offered training in using the autoclave machine, however for the purpose of our study we instead built 50 Pufferfish controllers so that we could dispose of each LEGO model after use with plenty of extra controllers for pilot testing and refinements. Both the MLTs and the infection control nurse argued for a toy-like form factor. The consensus among the MLTs was that vivid colors would be appealing for children and would stand out in the sterile context. This is supported by research that suggests decorative choices impact the acceptance of the equipment by children. For example, chemotherapy patients experienced significantly lower levels of anxiety and needle phobia when the needles and hypodermic syringes were decorated to appear as a butterfly or with sparkly stickers that might be appealing to children [23].

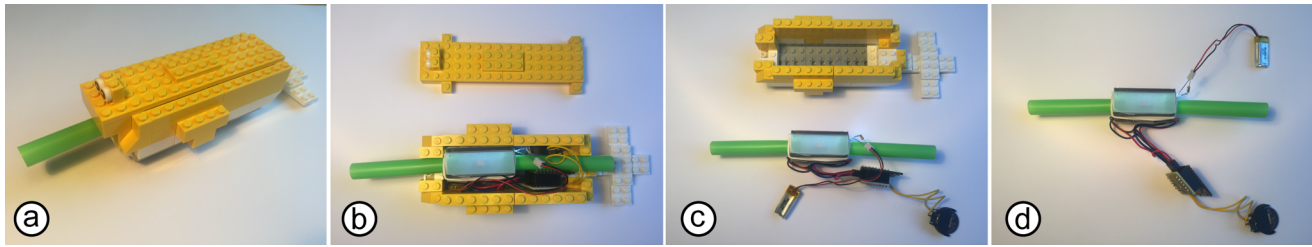

Figure 2: a) assembled Pufferfish controller as used by the participants, which required the child to place their mouth on and breathe through the straw shown on the left. b) the top layer of bricks removed, the interior of the Pufferfish controller reveals the electronic components c&d) electronic components removed from the LEGO brick body.

THE PUFFERFISH SYSTEM

We now introduce Pufferfish, a breath-based biofeedback game designed to distract and calm down children and their parents during blood sampling procedures. The system builds upon work presented in [43] where a similar 2D game is used. However, the breath-based biofeedback controller uses a completely new breath-sensing technique and has been designed to meet hygiene and safety demands.

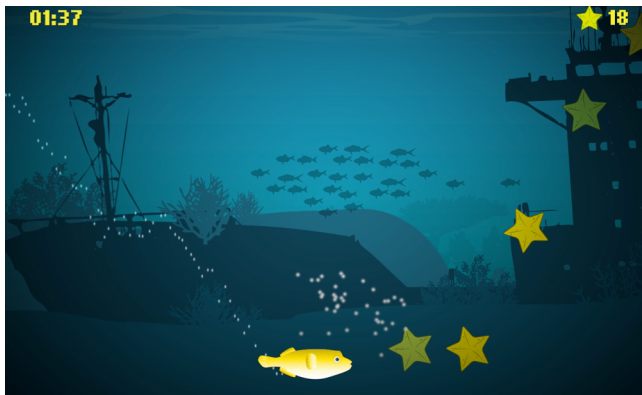

Figure 3: Screenshot of the Pufferfish gameplay.

The Pufferfish Biofeedback Game

The Pufferfish biofeedback game runs on an Android tablet and is implemented using the Unity Game Engine [52]. The gameplay is based on an underwater 2D side-scrolling world, where the objective is that the player character (a puffer fish) has to collect as many starfish as possible as seen in Figure 3. The vertical position of the player character is controlled by inhaling or exhaling through the mouthpiece on the physical controller shown in Figure 2a. The starfish are positioned in a sine wave pattern, so that to collect as many starfish as possible, the player has to follow a slow-paced breathing pattern similar to the ones used in well documented relaxing breathing techniques [22,42].

Technical Description of Tangible Pufferfish Controller

Although various technologies can sense respiration (see [3] for an overview), most are very expensive and require bulky equipment, which would not be suitable in the pediatric phlebotomy clinic. The tangible Pufferfish controller is built from LEGO bricks to resemble a fish as seen in Figure 2 and contains two analog light sensors, a white LED backlight module, an RFDuino microcontroller, two LiPo batteries, and a bespoke silicone sensor as

described below. Together, these electronic components can reliably detect when a child breathes in or out through the straw at the front of the controller. This information is transmitted via a wireless Bluetooth 4.0 connection to a tablet running the Pufferfish biofeedback game, where the information either moves the player character upwards or downwards depending on the child's breath.

Bespoke Silicone Sensor

In order to measure breath rate, it would be possible to use cumbersome and expensive medical equipment. However, this study points toward the feasibility of creating a simple medical device that could work in the clinic and perhaps become a personal coping technology for use outside the hospital setting. Aside from cost, medical spirometers and respiration devices further inhibit the patient and often cover the mouth and nose, which could result in a more restricted feeling contributing to stress. Furthermore, the precision achieved with more expensive sensors is not needed to measure general inhalation behaviors. To the best of our knowledge, sensing the airflow from breath with a contactless sensor has not been done in previous work aside from expensive medical equipment. The sensor we developed is based on the physics of a pendant vane flow meter [27] in which the deflection of an object immersed in the flow of a fluid results in a corresponding change in a display indicator. Our design incorporates all of the complex parts of a moving vane flow meter into a single solid piece of silicone. The design, development, and additional performance characteristics of the sensor will be detailed in a separate forthcoming article, but we present overview of the sensor and how it enables testing in the hospital context. The child breathes through a 1cm diameter straw protruding from the fish which forces air through the silicone sensor, which causes an opaque silicone pendant vane to move in the direction of the airflow and partially blocks the light directed toward two analog light sensors mounted to a PLA plate beside the silicone body (see Figure 5d). When the child inhales, the internal vane moves toward the mouth and blocks the frontmost light sensor as shown in Figure 4.

When the child exhales, the pendant vane moves in the other direction partially blocking the rearmost light sensor. When there is no airflow, the pendant vane returns to the center position and does not block either light sensor.

Two Adafruit GA1A12S202 log-scale analog light sensor breakout boards were cut in half to reduce the size and were affixed to a custom PLA sensor plate as shown in Figure 5e. The sensor plate provides two openings that collect light directly to each sensor. A custom PLA plate was designed to hold a white LED backlight module, which directs the cast light through the silicone piece toward the sensor plate.

The fabrication of the silicone pendant vane sensor follows an approach that has become popular in the field of microfluidics in that a special mould is created about which silicone is cast and then the mould is removed leaving a complex form that is only possible through an investment casting process [40]. Food-safe Bluesil 3428 RTV silicone was used with platinum catalysts resulting in a durable rubbery final product. We utilized transparent catalyst for the body and white catalyst for the pendant vane. The transparency of the block allows light from the LED backlight to pass through, yet some of the light is blocked by the white silicone pendant vane. This drop in light level is detected by the two light sensors (see Figure 5f,g).

The casting involves a double-shot process using two colors of catalyst. To begin, a small amount of the 3428 mixture was prepared with the white catalyst and placed into a sterile 5ml medical syringe fitted with an 18 gauge 40mm long hypodermic needle and injected into the void of the ABS negative as shown in Figure 6a. Before the white silicone was set, a large batch of silicone was prepared with transparent catalyst and is poured into a mould frame to a depth of approximately 2 cm. The previously prepared ABS negatives were placed in a mould frame (Figure 6b), additional transparent silicone was poured into each of the mould sections (Figure 6c). After 16 hours of curing time, the mould frame was cut and removed (Figure 6d) yielding the silicone blocks with the ABS negative embedded as shown in Figure 6e. The ABS negative was removed using repeated cycles of acetone bath and cotton swabs. The silicone was then washed with washing up liquid and a brush, then placed into a bath of boiling water and soaked in ethanol to complete the sterilization process. The result is a single block of silicone with embedded pendant vane as shown in Figure 6f.

PUFFERFISH STUDY DESIGN

Conducting the real-world evaluation in the hospital was particularly challenging and had implications for the study design. The study was conducted at a specialized phlebotomy clinic, which conducts blood testing for

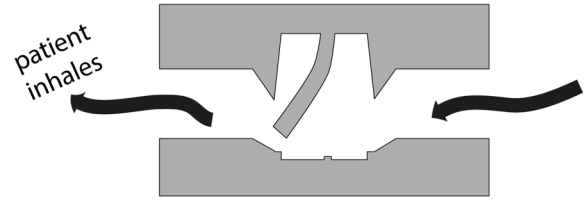

Figure 4: Cross-section drawings of the silicone sensor with pendant vane moving according to airflow during respiration.

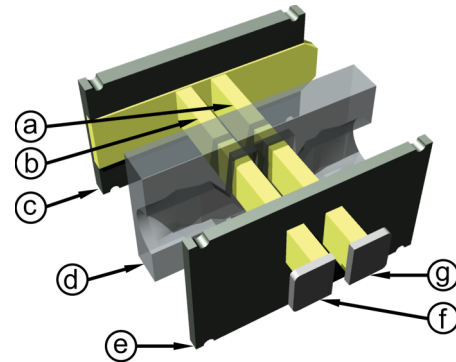

Figure 5: Silicone moving pendant flow sensor parts include: a) rearmost and b) frontmost column of light emitted from the c) LED backlight, which pass through the d) cast silicone, striking the e) sensor plate, f) front most and g) rear most analog light sensor

children suffering from rare conditions requiring long term treatment e.g. Vitamin D overdose, as well as more common, yet serious diseases e.g. Leukemia and other cancers.

We conducted an initial randomized controlled trial with 20 child participants who were assigned to one of two conditions: the Pufferfish active distraction technique for improving the blood draw procedure compared with standard passive distraction provided by watching a video. The Pufferfish condition involved playing the breath-based Pufferfish biofeedback game during the blood drawing procedure. The control condition presented a video of an aquarium. In both conditions, video elements were presented on a tablet positioned on a stand next to the child (see Figure 1). Prior to beginning the study, ethical clearance was granted by the regional ethics committee. Participants received no reimbursement for participating in the study.

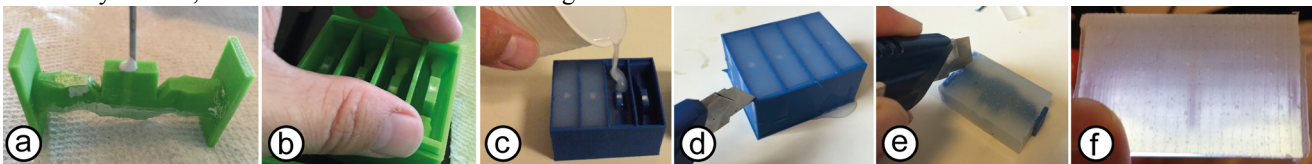

Figure 6: Overview of the fabrication process. a) silicone with opaque white catalyst injected into 3D printed ABS negative b) prepared negatives are placed in the mould frame c) silicone with transparent catalyst is poured into mould frame d) after silicone has cured, mould frame is cut to access individual cast pieces e) each cast piece is trimmed to remove excess silicone f) after acetone bath has removed ABS negatives, LED light shone through the resulting piece reveals the shadow cast by the internal pendant

Our hypothesis was that active distraction provided by the Pufferfish breathing technique would result in better patient and clinician experiences during venipuncture and blood sampling procedures, compared to the control condition.

Questionnaire Measures Used

Glasses Fear Scale

The Glasses Fear Scale is a variation of the Visual Analog Scale (VAS) designed for making children self-assess their fear [11]. The Glasses Fear Scale consists of a visual representation of six cylinders (glasses). The first cylinder is empty meaning *no fear*, and the remaining five cylinders is filled with increasing amounts of fear. The last (sixth) cylinder is completely filled meaning *most fear*. The cylinders are assigned a value from 0 (*no fear*) to 5 (*most fear*). Children reported their level of fear before the procedure. Following the procedure children reported the fear they had experienced during the procedure.

Data collection	Data collection time	Collected information
Glasses Fear Scale*	B + A (before + after)	Child fear before / experienced fear
Faces Pain Scale*	B + A	Child expected / experienced pain
Visual Analog Scale*	B + A	Parent proxy assessments of their child’s expectations / experiences
Visual Analog Scale*	A	Parent reported self-experienced discomfort during the procedure
Level of Difficulty and Effect	A	MLT assessment of degree of procedure difficulty and effect of intervention.

Table 1: An overview of the data collected as part of the Pufferfish study. *Clinically validated.

Faces Pain Scale-revised

The Faces Pain Scale-revised is a self-assessment tool used to assess the intensity of a child’s pain [11]. The Faces Pain Scale consists of a facial scale with six faces, where *no pain* and *worst possible pain* are the extremes and the remaining four faces are in between these two. Prior to the procedure, the children reported their expected level of pain in the upcoming blood draw. Following the procedure, the children reported their experienced level of pain.

Visual Analog Scale (VAS)

The Visual Analog Scale is an instrument that measures continuous factors. It has been validated through various studies [2,16]. The VAS is a 10cm horizontal line. The parents marked on the line the point that they felt represented their answer, and the score [30] on the VAS

was determined by measuring in centimeters from the left on the line to the point that the parent marked.

Parents were asked to mark, how worried their child was before the blood test on a VAS with the endpoints “*Not worried*” to “*Most worried*”. The parents also rated their own level of worry before the blood test. In addition, parents were asked to mark, how painful they expected the blood test to be for their child on a VAS with endpoints “*No Pain*” to “*Worst possible pain*”. After the blood test, parents reported their assessment of how much fear and pain the child experienced during the blood test using VAS with the endpoints “*No fear*” to “*Most fear*”, and “*No pain*” to “*Worst pain*”. The parents reported their own level of discomfort during the blood test using a VAS with the endpoints “*No discomfort*” to “*Worst discomfort*”.

MLT assessed level of difficulty and effect of intervention

The MLT rated after the blood draw procedure on a 5-points Likert scale the level of difficulty of the blood drawing from 1 “*Unproblematic*” to 5 “*Very problematic*”. In addition, the MLT scored the usefulness of the intervention (Pufferfish/control) on a 5-point Likert scale from “*Very Useful (it made a big positive impact)*” to “*Not at all useful (it made a big negative impact)*”.

Participants

We recruited 20 children and their parents to participate in our study. Our inclusion criteria included that the participants should be children aged between six and eleven already scheduled to have a blood sample taken at the hospital, and accompanied by parents who were able to read and speak *LANGUAGE BLINDED FOR REVIEW*. Table 2 provides an overview of the participants.

Gaining access to this patient population required careful review by the IRB of the university and research staff at the hospital. The sample size is comparable to related studies [12,17,25,30,50] and exercises due care to ensure that any unforeseen harm to patients could be reduced before approval of a larger study.

Condition	Age	Gender	# of previous blood samples
Active distraction	M = 9.4	3 Male	M = 39
	SD = 1.6	7 Female	SD = 48
Passive distraction	M = 7.9	5 Male	M = 14
	SD = 1.9	5 Female	SD = 10

Table 2: Participant information

Procedure

The child and the accompanying parent were informed about the project in the waiting room prior to the blood sampling. If the child and parent fitted the inclusion criteria, they were invited to participate in the study. Both had to give oral consent to participate, and the parent also had to provide written consent. The child and parent then

completed the questionnaire as seen in Table 1. The parent was also asked to provide background information about the child (age, number of previous blood samples etc.). After answering these questions the child was randomly assigned to either active or passive distraction, at which point was introduced respective technology. A researcher joined the patient in the room in order to collect information about the blood draw procedure and the interactions with the technology. The researcher did not initiate any interactions with the child, parent or MLT during the procedure.

After the blood sampling procedure, the child, parent, and MLT answered short questionnaires (see Table 1). In addition, families were afterwards asked to participate in semi-structured interviews about their experiences with the blood test and the intervention.

Children and parents were only informed about the condition they were assigned to. Similarly, the MLTs were introduced neutrally to the two study conditions. None of MLTs from this study were involved with or knew about the earlier described design process.

Data Analysis

All included participants completed the measures before the blood sampling procedure. One child assigned to the Pufferfish condition was extremely anxious and physically resisted the blood draw procedure and was deemed by the MLT to be in a state unsuitable for safe blood draw procedures. Therefore, only nine families in the Pufferfish group completed the measures.

Due to the low sample size, and therefore low statistical power in this study, a non-significant p-value does not necessarily indicate the absence of an effect [46]. Thus, to estimate the magnitude of the difference between the conditions the effect size was reported in all analyses. An effect size of $r=0.1$ indicated a small effect, $r=0.3$ a moderate effect, and $r=0.5$ a large effect.

Glasses Fear Scale and Faces Pain Scale Processing

Glasses Fear Scale and the Faces Pain Scale measures from before and after the blood sampling procedure for both conditions (Pufferfish/control) were compared with two-tailed Mann–Whitney U tests.

MLT Level of Difficulty and Effect Processing

A two-tailed Mann–Whitney U test was used to compare the MLT's assessment of the level of difficulty of the blood draw between the two conditions. Similarly, a two-tailed Mann–Whitney U test was used to compare the MLT's assessment of the level of usefulness of the intervention between the two conditions.

Differences in self-reported and parent-reported scores between conditions.

Differences between the conditions reported on Glasses Fear Scale, the Faces Pain Scale, and Visual Analog Scales were compared with two-tailed Mann–Whitney U tests.

QUANTITATIVE RESULTS

The results of the data analysis showed general positive effects of both distraction conditions, and most parents would recommend the distraction technique to a friend (passive 78%, active 89%). Children easily understood and engaged with the Pufferfish game collecting points by navigating the fish through controlled breathing even during the longer and more complicated blood draw procedures. Both conditions involved blood draw procedures of similar complexity, rated by the MLTs as Pufferfish condition (Mdn = 3; *neutral*) and control condition (Mdn = 2; *somewhat unproblematic*), $z = 0.79$, $p = 0.59$, $r=0.12$.

As shown in Figure 7, the parents in the active distraction condition reported higher levels of fear before the procedure and expected their children to experience more pain compared to the passive distraction condition. The differences between the conditions were not significant and with small effect sizes for all measures except the parents' rating of their own level of worry, where parents in the active condition rated a significant higher level of worry ($Z=-2.35$, $p=0.02$, $r=0.58$). These results indicate that the random allocation to the conditions did not balance potential differences between the groups, which may have affected the differences between the conditions. The parents in the Pufferfish condition had more worries before the blood test and rated their children to be more anxious before the test compared to parents in the passive distraction condition. As shown in Figure 7, this was not the case when children rated their own level of fear before the blood test, where children in both conditions reported similar level of fear before the blood test.

Higher MLT-rated Effect from Using Pufferfish

There was a significant improvement in responses to the MLT-reported answer to the question “*On a scale from 1-5, how useful did you experience the Pufferfish/Tablet Movie distraction under the blood sampling you have just completed*” between the Pufferfish condition (Mdn = 2: *useful - made a positive difference*) and the control condition (Mdn = 3: *Neutral - did not make any difference*), $z = -2.04$, $p=0.02$, $r = 0.55$.

Parents Report Less Pain than Expected in the Pufferfish Condition

The level of pain both parents and children expected before the blood test was not comparable to how painful the blood test procedure actually was rated. Both children and parents in the Pufferfish condition overestimated the painfulness of the procedure before the blood test when compared to the actual level of pain during the procedure. When compared to the parents in the passive distraction group the parents in the active distraction group reported a significantly lower level of pain during the procedure than they were expecting.

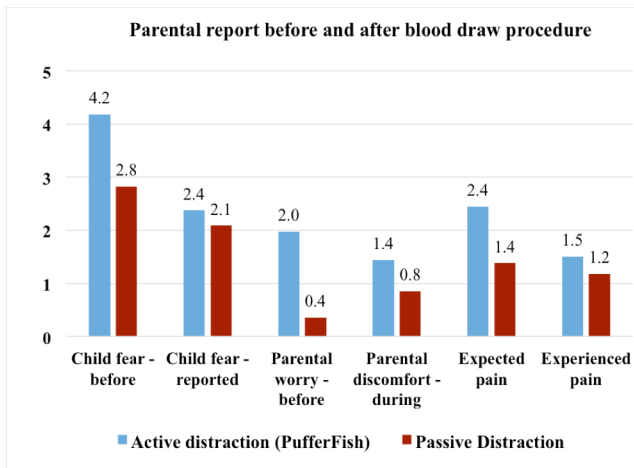

Figure 7: Summary of parental responses before and after the blood sampling procedure.

This difference was statistically significant ($p=0.04$) and with a moderate effect size ($z=-2.00$, $p=0.04$, $r=0.46$). This result indicates that the procedure was not as painful as expected for the Pufferfish condition. The difference between the children’s expected and actual pain was not statistically significant and showed a small effect size ($z=-0.94$, $p=0.35$, $r=0.22$).

Positive Effects of Pufferfish on Parent-reported Child Pain and Fear

The use of the active distraction (Pufferfish) during the blood test had a larger effect compared to the passive distraction on the children’s experience of fear and pain. As shown in Figure 8 children in the active distraction condition reported less fear and pain during the blood test compared to children in the passive distraction condition. However, the difference did not reach a significant level and showed small effect sizes ($z=-1.08$, $p=0.45$, $r=0.17$ and $z=-0.76$, $p=0.28$, $r=0.25$, respectively).

QUALITATIVE RESULTS

Analysis of the qualitative data further supports the quantitative findings that show positive benefits of the Pufferfish condition. After one of the procedures in the Pufferfish condition, the mother said to her child (T13): “*You did not even cry this time!*” Afterwards, the mother told us that this was the first time that the daughter had not resisted or cried during a blood sampling procedure (the mother had, prior to the blood test reported that her child had experienced 20 blood tests). We experienced similar positive sentiment from a parent of another Pufferfish participant in which the father handed back the completed questionnaire and asked if the technology could be made available for his child during their child’s next blood draw procedure. The video condition did not elicit any specific comments from the parents yet was found to be received positively.

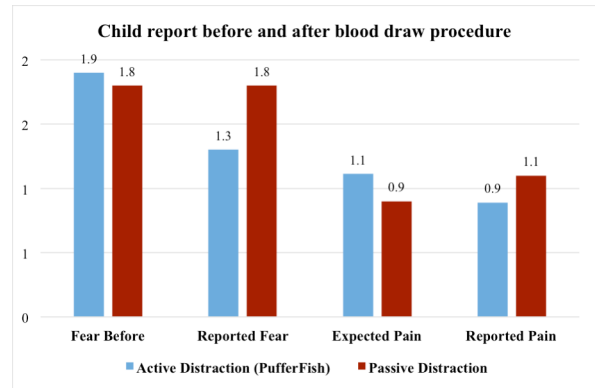

Figure 8: Child reported fear and pain before and after.

The MLTs and Parents Turned the Passive Distraction Condition into an Active Distraction Condition

In our study we were surprised to observe that both parents and the MLTs in almost all 10 cases in the passive distraction condition turned the passive distraction (a side scrolling aquarium movie) into an active distraction. In most cases the MLT would soon after the child had sat down ask a question related to the movie e.g., “*Do you think we will see a small shark?*” or “*How many fish are there right now?*”. In this way, the MLT turned the passive distraction into an active distraction where the MLT (and sometimes also the parent) would continuously ask questions about the aquarium movie to distract the child.

Three Emergent Patient Types

From a combined analysis of the child-reported Glasses Fear Scale questionnaire, our observations of the blood drawing procedure, and follow up interviews with MLTs three main patient types emerged: 1) ‘Not afraid’, 2) ‘Semi afraid’, and 3) ‘Highly anxious’.

The children in the ‘not afraid’ group reported *no fear* (score = 0) in the Glasses Fear Scale questionnaire completed prior to the blood sampling procedure. These children were very independent, did not express worry before or during the blood draw, and did not pay any attention to the passive distraction condition. Instead, several of the children preferred to follow along in the preparations and the actual blood drawing.

The children in the ‘semi afraid’ group reported Glasses Fear Scale scores between 1 and 3. These children benefitted from distractions, and a few even had their own existing coping strategy (smartphone game, teddy bear etc.). They were generally worried about the pain and somewhat influenced by environment and other stressors.

The ‘highly anxious’ children in our study (we had three) all reported a score of 5 (*most fear*) on the Glasses Fear Scale. This group might include children with needle phobias as also noted in [47]. From our observations, these children did not seem to exhibit an exaggerated level of fear in the waiting room, however as soon as they entered the blood drawing room, they instantly became very anxious

and often refused even simple requests like walking to the chair or rolling up their sleeves. In our study, an extra MLT was called in to assist, however in all cases the parent ended up having to physically restrain the child in order to get the blood sample. However, in one of our cases, the child exhibited so much resistance that the MLT could and would not try to draw the blood due to the risk of a needle accident. These children seemed pay too much attention the needle and the expected pain.

Distraction was not Efficacious for all Children

For several of the children in our study the degree of distraction provided by the two conditions was not enough to distract them from their fear of the needle. These children included all of the children in the highly anxious' group and several from the 'semi afraid' as discussed above.

In these situations, the child would only engage in the intervention for a short while and would continuously return their attention to the procedure, resulting in a vicious cycle of increasing anxiety. From our observations, neither the passive or active condition had any effect on these children, which was also supported in the MLTs questionnaire responses in these situations. The first time we observed such a situation we asked the MLT if she believed that a hospital clown could have assisted the child to calm down to which she responded "*No. In situations like these, there is nothing to do*". In these situations the blood drawing procedure often required an extra MLT to assists, and if this did not help, the parent and the extra MLT together had to physically restrain the child in order to draw the blood (if the parent approved of this). However, as we experienced with one of the patients, two adults cannot always physically restraint the child enough to allow for a blood sample as the child might fight.

Differences in Social Interactions

A review of the formal characteristics of the distraction techniques used in this study reveals similarities and key differences. We describe how the participants responded to the distraction techniques to illustrate in what ways the treatments affected the social interactions between the patient, parent, and MLTs.

In both interventions, the technology became a shared focal point and provided a hook or a "ticket to talk", which engaged the MLTs, patients and parents. Both in the Pufferfish and the control condition, we observed that the MLTs and the parents used the interventions to distract the child as exemplified by a patient's mother saying "*Can you find Nemo?*" and by a MLT saying "*how many starfish have you got now?*". Furthermore, parents from both conditions afterwards commented that positive effects of both conditions included distraction.

In both conditions we observed that MLTs and parents often engaged with the interventions to encourage the distraction of the child. In the Pufferfish condition, this

engagement was limited to cheering for and instructing the child to inhale and exhale, while the aquarium video provided many opportunities to engage the child in discussion, for example asking if s/he had seen that new fish, counting the fish together, or asking specifically about one of the fish, as the MLT asked, "Did you see a yellow fish yet? What do you think the yellow fish is doing?" Although the game provided a challenge requiring the child to actively engage and navigate the fish, there was a lack of additional texture and details for encouraging conversation.

DISCUSSION

Using Technology to Support Different Patient Types

In the following, we will discuss implications for the design of technologies in the hospital context suited for the three patient types identified previously.

We learned that children in the 'highly anxious' group did not benefit from either distraction condition. According to Thurgate and Heppell, children with a high level of anxiety need special treatment in order to avoid developing or reducing their needle phobia [47]. Thurgate and Heppell developed a three-step approach for overcoming needle phobia that focused on relaxation, control, and graded exposure [47]. Children that assess their own fear to be four or greater (on a 10-point scale) should, according to Thurgate and Heppell undergo their three-step approach to overcome their anxiety and support positive experiences with medical procedures involving needles.

The Pufferfish condition was designed to both distract and assist the child to perform a relaxing breathing exercise. However, according to Thurgate and Heppell's findings, one possible reason that children in the 'highly anxious' group did not benefit from the either of the interventions was that they were delivered too late.

Currently, HCI research on pediatric technology is mainly focused on interventions for the waiting room (e.g., [28,48]) and interventions during the medical procedure (e.g., [1,9,31]). However, as suggested by Thurgate and Heppell, taking a more holistic approach when designing for the pediatric hospital domain might be more appropriate. This is supported by a recent medical study which found that a combination of a calming intervention in the waiting room and an intervention during the medical needle procedure was significantly more effective than any of the two separately [33].

Though little HCI work has taken a holistic approach to the patient experience of pediatric procedures, our findings and related work suggest that allowing for personalized treatment of the child according to their anxiety level can improve the effectiveness of the distractions / interventions and reduce child anxiety.

Active Distraction Provided Soft Physical Restraint

There were key differences in the ways the distractions affected the bodily experiences of the children. In both

conditions, the same tablet was used for onscreen content, and it was placed next to the child away from the needle insertion arm. This encouraged children's heads to be oriented away from the needle insertion point. In the Pufferfish condition, however, there were a few additional influences on the body that were not present for the video condition. The Pufferfish controller required the children to place their mouth on the breathing tube, which reduced the opportunities for the child to speak. In the passive distraction condition, the children could speak freely or cry out when the needle was inserted. Furthermore, the Pufferfish condition had a direct influence on the children's breathing and encouraged a breathing pattern that has been shown to be relaxing for children [22,42], whereas the video condition involved no guidance for the breathing behaviors. Considering the impact of the two distraction types, our findings highlight a tension created with the videogame related to control and the body. In the blood draw experience, the child has been brought to the hospital by the parent where they have reduced control over their body and the related testing. By playing the Pufferfish game, the child must remain oriented to the screen, and must generally remain still in order to breathe through the controller. The result is that the child does not move away from the needle and does not resist the procedure. It may be that the child engages with the game and while giving up control of their own body, they can control something—the video game. Passive distraction on the other hand, offers little physical control to the child except from opting out entirely. Providing a feeling of situational and bodily control has been shown in the literature to improve the experience and emotional state of children [47].

The Influence of Parents on Procedures

As we identified in our initial design process and the literature [47], parental worry and anxiety is transferred to the child. In both conditions we saw that parents actively engaged in the distractions and that they would recommend the intervention to others, suggesting that the parents found both interventions to be an improvement to the blood sampling procedure independent of their own anxiety level. As noted previously, the MLTs claimed that parents either build confidence for their child or can easily transfer their anxiety. Although we did not see this transfer to children, we did however encounter one family where both the mother and father accompanied the child to the hospital and their coping strategy was to have the calm father accompany the child during the procedure. They explained that the mother would easily upset the daughter due to her own anxieties related to needles. We hope that this draws attention to designing for the complex family dynamic.

Limitations

We now discuss and evaluate several aspects of this study that present possible limitations. These include limited information on patient health history, number of study participants, the breadth and granularity of logged data, the design of the distractions, and environmental factors in the

hospital setting. We now discuss how these might affect the validity of the contribution.

Participants in the study varied in terms of medical history, which might have affected the response to the distraction techniques. Based on the wide range of previous blood tests from 1 to 150, it is apparent that the participants are living with a range of conditions and as the head of the phlebotomy department noted, this means that stage of diagnosis, medications prescribed, and treatments vary from child to child. While future studies can target more narrow segments of the blood clinic patients, the breadth of the current study serves to illustrate the diverse experiences of child patients and has provided insights into the further refinement of breathing based distraction games. Furthermore, the number of patients included in the study follows sample sizes for exploratory medical research on children undergoing venipuncture and injections [12,17,25,30,50] and was sufficient to understand initial responses to breath-based biofeedback games.

This study examined responses to two forms of distraction using self-reported data, however we did not gather physiological data such as heart rate or skin conductance. While these measures could provide additional insights to the patient experience in larger sample sizes, these measures would require additional equipment attached to the child, which might negatively impact the child's fear for the upcoming procedure. Instead, the findings from the presented study provide insights into the responses to distraction technologies.

CONCLUSION

In this work, we presented an initial RCT study to investigate potential benefits of distraction techniques that combine breath-based relaxation exercises and digital games for children who undergo stressful blood draw procedures. Our study was conducted in a pediatric hospital context involving 20 children aged between 6 and 11 and their families. Participants were randomly assigned to either a passive or an action distraction condition involving watching a video or actively playing the breath-based Pufferfish game, respectively. We developed a bespoke breath sensor embedded in a tangible controller to satisfy the demands of safety and infection control of the hospital. Our findings show that the use of Pufferfish was associated with an improvement in the blood draw procedure and showed positive impact on the child's pain and fear during the blood test. The medical laboratory technicians rated the active distraction provided by Pufferfish significantly more helpful than passive distraction. Based on our qualitative analysis we identified aspects that impact the acceptance of breath-based active distraction and highlighted three emergent patient profiles. This research highlights the potential of non-pharmacological assistive technology tools to reduce fear and pain for children undergoing painful or stressful medical treatment.

REFERENCES

1. Setareh Aghel Manesh, Tanya Beran, Ehud Sharlin, and Saul Greenberg. 2014. Medi, Human Robot Interaction in Pediatric Health. In *CHI '14 Extended Abstracts on Human Factors in Computing Systems (CHI EA '14)*, 153–154. <http://doi.org/10.1145/2559206.2579529>
2. R. C. Aitken. 1969. Measurement of feelings using visual analogue scales. *Proceedings of the Royal Society of Medicine* 62, 10: 989–993.
3. Farah Q. AL-Khalidi, R. Saatchi, D. Burke, H. Elphick, and S. Tan. 2011. Respiration rate monitoring methods: A review. *Pediatric Pulmonology* 46, 6: 523–529. <http://doi.org/10.1002/ppul.21416>
4. Jakob E. Bardram. 2004. Applications of Context-aware Computing in Hospital Work: Examples and Design Principles. In *Proceedings of the 2004 ACM Symposium on Applied Computing (SAC '04)*, 1574–1579. <http://doi.org/10.1145/967900.968215>
5. Amy L. Baxter, Lindsey L. Cohen, Heather L. McElvery, Mona Louise Lawson, and Carl L. von Baeyer. 2011. An Integration of Vibration and Cold Relieves Venipuncture Pain in a Pediatric Emergency Department. *Pediatric Emergency Care* 27, 12: 1151–1156. <http://doi.org/10.1097/PEC.0b013e318237ace4>
6. Tanya N. Beran, Alex Ramirez-Serrano, Otto G. Vanderkooi, and Susan Kuhn. 2013. Reducing children's pain and distress towards flu vaccinations: A novel and effective application of humanoid robotics. *Vaccine* 31, 25: 2772–2777. <http://doi.org/10.1016/j.vaccine.2013.03.056>
7. Tanya N. Beran, Alex Ramirez-Serrano, Otto G. Vanderkooi, and Susan Kuhn. 2015. Humanoid robotics in health care: An exploration of children's and parents' emotional reactions. *Journal of Health Psychology* 20, 7: 984–989. <http://doi.org/10.1177/1359105313504794>
8. Ronald L. Blount, Pamela J. Bachanas, Scott W. Powers, et al. 1992. Training children to cope and parents to coach them during routine immunizations: Effects on child, parent, and staff behaviors. *Behavior Therapy* 23, 4: 689–705.
9. Sam Bucolo, Jonathan Mott, and Roy Kimble. 2006. The Design of a Tangible Interaction Device to Alleviate Anxiety and Pain in Paediatric Burns Patients. In *CHI '06 Extended Abstracts on Human Factors in Computing Systems (CHI EA '06)*, 129–134. <http://doi.org/10.1145/1125451.1125482>
10. Amanda J. Carter, Mary-Louise C. Greer, Simon E. Gray, and Robert S. Ware. 2010. Mock MRI: reducing the need for anaesthesia in children. *Pediatric Radiology* 40, 8: 1368–1374. <http://doi.org/10.1007/s00247-010-1554-5>
11. Kim Cavender, Melinda D. Goff, Ellen C. Hollon, and Cathie E. Guzzetta. 2004. Parents' positioning and distracting children during venipuncture. Effects on children's pain, fear, and distress. *Journal of Holistic Nursing: Official Journal of the American Holistic Nurses' Association* 22, 1: 32–56. <http://doi.org/10.1177/0898010104263306>
12. Lynnnda M. Dahlquist, Suzanne M. Busby, Keith J. Slifer, et al. 2002. Distraction for children of different ages who undergo repeated needle sticks. *Journal of Pediatric Oncology Nursing: Official Journal of the Association of Pediatric Oncology Nurses* 19, 1: 22–34.
13. Melissa DeMore and Lindsey L. Cohen. Distraction for Pediatric Immunization Pain: A Critical Review. *Journal of Clinical Psychology in Medical Settings* 12, 4: 281–291. <http://doi.org/10.1007/s10880-005-7813-1>
14. Debra Fanurik, Jeffrey L. Koh, and Michael L. Schmitz. 2000. Distraction Techniques Combined With EMLA: Effects on IV Insertion Pain and Distress in Children. *Children's Health Care* 29, 2: 87–101. http://doi.org/10.1207/S15326888CHC2902_2
15. Gina M. French, Eileen C. Painter, and Daniel L. Coury. 1994. Blowing away shot pain: a technique for pain management during immunization during immunization. *Pediatrics* 93, 3: 384–388.
16. Audrey G. Gift. 1989. Visual analogue scales: measurement of subjective phenomena. *Nursing research* 38, 5: 286–287.
17. Jeffrey I. Gold, Seok Hyeon Kim, Alexis J. Kant, Michael H. Joseph, and Albert Skip Rizzo. 2006. Effectiveness of virtual reality for pediatric pain distraction during i.v. placement. *Cyberpsychology & Behavior: The Impact of the Internet, Multimedia and Virtual Reality on Behavior and Society* 9, 2: 207–212. <http://doi.org/10.1089/cpb.2006.9.207>
18. Devendra Gupta, Anil Agarwal, Sanjay Dhiraaj, et al. 2006. An evaluation of efficacy of balloon inflation on venous cannulation pain in children: a prospective, randomized, controlled study. *Anesthesia & Analgesia* 102, 5: 1372–1375.
19. Jason Harris, Sarah Vance, Odair Fernandes, Avinash Parnandi, and Ricardo Gutierrez-Osuna. 2014. Sonic Respiration: Controlling Respiration Rate Through Auditory Biofeedback. In *CHI '14 Extended Abstracts on Human Factors in Computing Systems (CHI EA '14)*, 2383–2388. <http://doi.org/10.1145/2559206.2581233>
20. Karen Holtzblatt and Hugh Beyer. 2014. Contextual Design: Evolved. *Synthesis Lectures on Human-Centered Informatics* 7, 4: 1–91. http://doi.org/10.2200/S00597ED1V01Y201409HCI02_4
21. Sooyeon Jeong, Deirdre E. Logan, Matthew S. Goodwin, et al. 2015. A Social Robot to Mitigate Stress, Anxiety, and Pain in Hospital Pediatric Care. In *Proceedings of the Tenth Annual ACM/IEEE International Conference on Human-Robot Interaction Extended Abstracts*, 103–104.
22. Ravinder Jerath, John W. Edry, Vernon A. Barnes, and Vandna Jerath. 2006. Physiology of long pranayamic breathing: neural respiratory elements may provide a

- mechanism that explains how slow deep breathing shifts the autonomic nervous system. *Medical Hypotheses* 67, 3: 566–571. <http://doi.org/10.1016/j.mehy.2006.02.042>
23. Sharon C. Kettwich, Wilmer L. Sibbitt, John R. Brandt, Courtney R. Johnson, Craig S. Wong, and Arthur D. Bankhurst. 2007. Needle Phobia and Stress-Reducing Medical Devices in Pediatric and Adult Chemotherapy Patients. *Journal of Pediatric Oncology Nursing* 24, 1: 20–28. <http://doi.org/10.1177/1043454206296023>
 24. C. Kleiber and D. C. Harper. 1999. Effects of distraction on children's pain and distress during medical procedures: a meta-analysis. *Nursing Research* 48, 1: 44–49.
 25. Donna Koller and Ran D. Goldman. 2012. Distraction Techniques for Children Undergoing Procedures: A Critical Review of Pediatric Research. *Journal of Pediatric Nursing* 27, 6: 652–681. <http://doi.org/10.1016/j.pedn.2011.08.001>
 26. Baruch Krauss and Steven M. Green. 2006. Procedural sedation and analgesia in children. *Lancet (London, England)* 367, 9512: 766–780. [http://doi.org/10.1016/S0140-6736\(06\)68230-5](http://doi.org/10.1016/S0140-6736(06)68230-5)
 27. Parshall Ralph L. 1956. Pendant vane flow meter. Retrieved September 18, 2016 from <http://www.google.com/patents/US2765656>
 28. Szu-Chia Lu, Andy Wu, and Ellen Yi-Luen Do. 2011. mediPuppet: an interactive comforting companion for children while visiting a doctor. In *Proceedings of the 8th ACM conference on Creativity and cognition*, 367–368.
 29. Diana MacLean, Asta Roseway, and Mary Czerwinski. 2013. MoodWings: A Wearable Biofeedback Device for Real-time Stress Intervention. In *Proceedings of the 6th International Conference on Pervasive Technologies Related to Assistive Environments (PETRA '13)*, 66:1–66:8. <http://doi.org/10.1145/2504335.2504406>
 30. Sharon L. Manne, William H. Redd, Paul B. Jacobsen, Kenneth Gorfinkle, Ora Schorr, and Bruce Rapkin. 1990. Behavioral intervention to reduce child and parent distress during venipuncture. *Journal of consulting and Clinical Psychology* 58, 5: 565.
 31. Chris McCarthy, Jo Butchart, Michael George, et al. 2015. Robots in Rehab: Towards socially assistive robots for paediatric rehabilitation. In *Proceedings of the Annual Meeting of the Australian Special Interest Group for Computer Human Interaction*, 39–43.
 32. Kate Miller, Sylvia Rodger, Sam Bucolo, Ristan Greer, and Roy M. Kimble. 2010. Multi-modal distraction. Using technology to combat pain in young children with burn injuries. *Burns* 36, 5: 647–658. <http://doi.org/10.1016/j.burns.2009.06.199>
 33. Kate Miller, Xianghong Tan, Andrew Dillon Hobson, et al. 2016. A Prospective Randomized Controlled Trial of Nonpharmacological Pain Management During Intravenous Cannulation in a Pediatric Emergency Department. *Pediatric Emergency Care* 32, 7: 444–451. <http://doi.org/10.1097/PEC.0000000000000778>
 34. M. Minute, L. Badina, G. Cont, et al. 2012. Videogame playing as distraction technique in course of venipuncture. *La Pediatria Medica E Chirurgica: Medical and Surgical Pediatrics* 34, 2: 77–83. <http://doi.org/10.4081/pmc.2012.64>
 35. Stuart Moran, Nils Jäger, Holger Schnädelbach, and Kevin Glover. 2016. ExoPranayama: a biofeedback-driven actuated environment for supporting yoga breathing practices. *Personal and Ubiquitous Computing* 20, 2: 261–275. <http://doi.org/10.1007/s00779-016-0910-3>
 36. Neema Moraveji, Ben Olson, Truc Nguyen, et al. 2011. Peripheral Paced Respiration: Influencing User Physiology During Information Work. In *Proceedings of the 24th Annual ACM Symposium on User Interface Software and Technology (UIST '11)*, 423–428. <http://doi.org/10.1145/2047196.2047250>
 37. Jonathan Mott, Sam Bucolo, Leila Cuttle, et al. 2008. The efficacy of an augmented virtual reality system to alleviate pain in children undergoing burns dressing changes: a randomised controlled trial. *Burns* 34, 6: 803–808.
 38. Avinash Parnandi, Beena Ahmed, Eva Shipp, and Ricardo Gutierrez-Osuna. 2014. Chill-Out: Relaxation Training through Respiratory Biofeedback in a Mobile Casual Game. In *Mobile Computing, Applications, and Services*, Gérard Memmi and Ulf Blanke (eds.). Springer International Publishing, 252–260. Retrieved March 10, 2015 from http://link.springer.com/chapter/10.1007/978-3-319-05452-0_18
 39. L. Peterson. 1989. Coping by children undergoing stressful medical procedures: some conceptual, methodological, and therapeutic issues. *Journal of Consulting and Clinical Psychology* 57, 3: 380–387.
 40. Vittorio Saggiomo and Aldrik H. Velders. 2015. Simple 3D Printed Scaffold-Removal Method for the Fabrication of Intricate Microfluidic Devices. *Advanced Science* 2, 9: n/a-n/a. <http://doi.org/10.1002/advs.201500125>
 41. Nejlá Canbulat Sahiner and Meltem Demirgoz Bal. 2016. The effects of three different distraction methods on pain and anxiety in children. *Journal of Child Health Care: For Professionals Working with Children in the Hospital and Community* 20, 3: 277–285. <http://doi.org/10.1177/1367493515587062>
 42. Hye-Sue Song and Paul M. Lehrer. 2003. The Effects of Specific Respiratory Rates on Heart Rate and Heart Rate Variability. *Applied Psychophysiology and Biofeedback* 28, 1: 13–23. <http://doi.org/10.1023/A:1022312815649>
 43. Tobias Sonne and Mads Møller Jensen. 2016. ChillFish: A Respiration Game for Children with ADHD. In *Proceedings of the TEI '16: Tenth International Conference on Tangible, Embedded, and Embodied*

- Interaction* (TEI '16), 271–278.
<http://doi.org/10.1145/2839462.2839480>
44. L. Sparks. 2001. Taking the “ouch” out of injections for children. Using distraction to decrease pain. *MCN. The American journal of maternal child nursing* 26, 2: 72–78.
45. Allan Stisen, Nervo Verdezoto, Henrik Blunck, Mikkel Baun Kjærgaard, and Kaj Grønbæk. 2016. Accounting for the Invisible Work of Hospital Orderlies: Designing for Local and Global Coordination. In *Proceedings of the 19th ACM Conference on Computer-Supported Cooperative Work & Social Computing* (CSCW '16), 980–992.
<http://doi.org/10.1145/2818048.2820006>
46. Gail M. Sullivan and Richard Feinn. 2012. Using Effect Size—or Why the P Value Is Not Enough. *Journal of Graduate Medical Education* 4, 3: 279–282.
<http://doi.org/10.4300/JGME-D-12-00156.1>
47. Claire Thurgate and Sue Heppell. 2005. Needle phobia - changing venepuncture practice in ambulatory care. *Paediatric Nursing* 17, 9: 15–18.
48. Daniel Ullrich, Sarah Diefenbach, and Andreas Butz. 2016. Murphy Miserable Robot: A Companion to Support Children’s Well-being in Emotionally Difficult Situations. In *Proceedings of the 2016 CHI Conference Extended Abstracts on Human Factors in Computing Systems*, 3234–3240.
49. Rhonda Winskill. 2008. Minimising the “Ouch” - A Strategy to Minimise Pain, Fear and Anxiety in Children Presenting to Rural Emergency Departments. *HNE Handover: For Nurses and Midwives* 1, 1. Retrieved September 18, 2016 from <http://journals.sfu.ca/hneh/index.php/hneh/article/view/32>
50. Kate Wolitzky, Robyn Fivush, Elana Zimand, Larry Hodges, and Barbara Olasov Rothbaum PhD. 2005. Effectiveness of virtual reality distraction during a painful medical procedure in pediatric oncology patients. *Psychology & Health* 20, 6: 817–824.
<http://doi.org/10.1080/14768320500143339>
51. Hana Yoo, Sue Kim, Hea-Kung Hur, and Hee-Soon Kim. 2011. The effects of an animation distraction intervention on pain response of preschool children during venipuncture. *Applied Nursing Research* 24, 2: 94–100. <http://doi.org/10.1016/j.apnr.2009.03.005>
52. Unity - Game Engine. Retrieved September 17, 2016 from <https://unity3d.com/>