

HISTORY OF DIALYSIS IN THE UK: c. 1950–1980

The transcript of a Witness Seminar held by the Wellcome Trust Centre for the History of Medicine at UCL, London, on 26 February 2008

Edited by S M Crowther, L A Reynolds and E M Tansey

©The Trustee of the Wellcome Trust, London, 2009

First published by the Wellcome Trust Centre
for the History of Medicine at UCL, 2009

The Wellcome Trust Centre for the History of Medicine
at UCL is funded by the Wellcome Trust, which is
a registered charity, no. 210183.

ISBN 978 085484 122 6

All volumes are freely available online following the links to Publications/Wellcome Witnesses at
www.ucl.ac.uk/histmed

CONTENTS

Illustrations and credits	v
Abbreviations	vii
Witness Seminars: Meetings and publications; Acknowledgements E M Tansey, L A Reynolds and S M Crowther	ix
Introduction John Pickstone	xix
Transcript Edited by S M Crowther, L A Reynolds and E M Tansey	1
Appendix 1 Reminiscences of working with the Kolff rotating drum dialyzer, by Professor Kenneth Lowe	79
Appendix 2 From a letter written by Sir Graham Bull, 1979	84
References	87
Biographical notes	103
Index	113

ILLUSTRATIONS AND CREDITS

Figure 1	Willem (Pim) Kolff (1911–2009). Provided by Professor Christopher Blagg.	9
Figure 2	Belding Scribner (1921–2003). Reproduced by permission of the University of Washington.	10
Figure 3	Frank Parsons (1925–1989). Provided by Professor Christopher Blagg.	11
Figure 4	Kolff and Berk's first artificial kidney, 1942. Provided by Professor Christopher Blagg.	13
Figure 5	Professor Nils Alwall (1904–1986). Provided by Professor Stanley Shaldon.	14
Figure 6	Top: Diagram of the technique of continuous haemodialysis. Adapted from Scribner <i>et al.</i> (1960) Bottom: Arm plate and cannulas in place for long-term cannulation of arteries and veins. Adapted from Quinton <i>et al.</i> (1960).	16
Figure 7	Flat plate kidney using Kiil membranes, c. 1965. Provided by and reproduced with permission of Dr Rosemarie Baillod.	21
Figure 8	Dr Stanley Shaldon, at the Royal Free Hospital. Provided by Professor Robin Eady, from <i>World Medicine</i> 1 (15 February 1966): 19.	28
Figure 9	Dialysis patients at the Royal Free Hospital pictured in the <i>Evening News</i> , c. 1965. Provided by Professor Robin Eady.	31
Figure 10	Professor Robin Eady receiving haemodialysis in the 'side room' at the Royal Free Hospital renal unit, from the cover of <i>World Medicine</i> 1 (15 February 1966). Provided by Professor Robin Eady.	38

Figure 11	Professor Hugh de Wardener and Dr Anthony Wing from <i>World Medicine</i> 1 (15 February 1966): 23.	48
Figure 12	An example of home dialysis equipment <i>c.</i> 1965. Provided by Dr Rosemarie Baillod.	57
Figure 13	Mrs Diana Garratt, <i>née</i> Northover in 1969. Provided by Mrs Diana Garratt.	58
Figure 14	Pages from the diary of 11-year-old Diana Garratt for 5–8 June 1972. Provided by Mrs Diana Garratt.	63
Figure 15	The hand of a patient on dialysis for more than ten years, who had pain, stiffness and age-related carpal tunnel syndrome, <i>c.</i> 1985. Provided by Dr Rosemarie Baillod.	75

ABBREVIATIONS

ASAIO	American Society for Artificial Internal Organs
AWRE	Atomic Weapons Research Establishment
CAPD	Continuous ambulatory peritoneal dialysis
DHSS	Department of Health and Social Security
EDTA	European Dialysis and Transplant Association
ESRD	End stage renal disease
ESRF	End stage renal failure
MRC	Medical Research Council
NICE	National Institute for Health and Clinical Excellence
NIH	National Institutes of Health
NKC	Northwest Kidney Centers
NSF	National Service Framework
SAKC	Seattle Artificial Kidney Center
SLE	systemic lupus erythematosus

WITNESS SEMINARS: MEETINGS AND PUBLICATIONS¹

In 1990 the Wellcome Trust created a History of Twentieth Century Medicine Group, associated with the Academic Unit of the Wellcome Institute for the History of Medicine, to bring together clinicians, scientists, historians and others interested in contemporary medical history. Among a number of other initiatives the format of Witness Seminars, used by the Institute of Contemporary British History to address issues of recent political history, was adopted, to promote interaction between these different groups, to emphasize the potential benefits of working jointly, and to encourage the creation and deposit of archival sources for present and future use. In June 1999 the Governors of the Wellcome Trust decided that it would be appropriate for the Academic Unit to enjoy a more formal academic affiliation and turned the Unit into the Wellcome Trust Centre for the History of Medicine at UCL from 1 October 2000. The Wellcome Trust continues to fund the Witness Seminar programme via its support for the Centre.

The Witness Seminar is a particularly specialized form of oral history, where several people associated with a particular set of circumstances or events are invited to come together to discuss, debate, and agree or disagree about their memories. At the time of publication, the History of Twentieth Century Medicine Group has held more than 50 such meetings, most of which have been published, as listed on pages xiii–xvii.

Subjects are usually proposed by, or through, members of the Programme Committee of the Group, which includes professional historians of medicine, practising scientists and clinicians, and once an appropriate topic has been agreed, suitable participants are identified and invited. This inevitably leads to further contacts, and more suggestions of people to invite. As the organization of the meeting progresses, a flexible outline plan for the meeting is devised, usually with assistance from the meeting's chairman, and some participants are invited to 'set the ball rolling' on particular themes, by speaking for a short period to initiate and stimulate further discussion.

¹ The following is the standard introductory text to the *Wellcome Witnesses to Twentieth Century Medicine* series.

Each meeting is fully recorded, the tapes are transcribed and the unedited transcript is sent to every participant. Each is asked to check his or her own contributions and to provide brief biographical details. The editors turn the transcript into readable text, and participants' minor corrections and comments are incorporated into that text, while biographical and bibliographical details are added as footnotes, as are more substantial comments and additional material provided by participants. The final scripts are then sent to every contributor, accompanied by forms assigning copyright to the Wellcome Trust. Copies of all additional correspondence received during the editorial process are deposited with the records of each meeting in archives and manuscripts, Wellcome Library, London.

As with all our meetings, we hope that even if the precise details of some of the technical sections are not clear to the non-specialist, the sense and significance of the events will be understandable. Our aim is for the volumes that emerge from these meetings to inform those with a general interest in the history of modern medicine and medical science; to provide historians with new insights, fresh material for study, and further themes for research; and to emphasize to the participants that events of the recent past, of their own working lives, are of proper and necessary concern to historians.

**Members of the Programme Committee of the
History of Twentieth Century Medicine Group, 2009–10**

Professor Tilli Tansey – professor of the history of modern medical sciences, Wellcome Trust Centre for the History of Medicine at UCL (WTCHM) and chair

Dr Sanjoy Bhattacharya – reader in the history of medicine, WTCHM

Sir Christopher Booth – former director, Clinical Research Centre, Northwick Park Hospital, London

Dr John Ford – retired general practitioner, Tonbridge

Professor Richard Himsworth – former director of the Institute of Health, University of Cambridge

Professor Mark Jackson – professor of the history of medicine, Centre for Medical History, Exeter

Professor John Pickstone – Wellcome research professor, University of Manchester

Mrs Lois Reynolds – senior research assistant, WTCHM, and organizing secretary

Professor Lawrence Weaver – professor of child health, University of Glasgow, and consultant paediatrician in the Royal Hospital for Sick Children, Glasgow

ACKNOWLEDGEMENTS

'History of Dialysis, c. 1950–1980' was suggested as a suitable topic for a witness seminar by Dr John Turney, who assisted us in planning the meeting. We are very grateful to him for that input and for his excellent chairing of the occasion. We are particularly grateful to Professor John Pickstone for writing the Introduction to the published proceedings. Our additional thanks go to Professor Kenneth Lowe, who was unable to attend the meeting but read through an earlier draft of the transcript and offered helpful comments and advice, and has allowed us to reproduce some of his reminiscences in Appendix 1. We thank Dr Rosemarie Baillod for sharing her memories of Olga Heppell receiving the first home haemodialysis treatment in Europe, and we thank her, Professor Christopher Blagg, Professor Robin Eady, Mrs Diana Garratt and Professor Stanley Shaldon for help with illustrations. For permission to reproduce Figure 3, we also thank the University of Washington.

As with all our meetings, we depend a great deal on colleagues at the Wellcome Trust to ensure their smooth running, especially the Audiovisual Department and Wellcome Images. Mr Akio Morishima has supervised the design and production of this volume; Ms Liza Furnival provided the index; and Mrs Sarah Beanland, Ms Fiona Plowman and Mr Simon Reynolds have read the transcript for sense and consistency. Mrs Jaqui Carter transcribed the tape, and Mrs Wendy Kutner and Dr Daphne Christie assisted in running the meeting. Finally we thank the Wellcome Trust for supporting this programme.

Tilli Tansey

Lois Reynolds

Stefania Crowther

Wellcome Trust Centre for the History of Medicine at UCL

VOLUMES IN THIS SERIES*

1. **Technology transfer in Britain: The case of monoclonal antibodies
Self and non-self: A history of autoimmunity
Endogenous opiates
The Committee on Safety of Drugs (1997)**
ISBN 1 86983 579 4
2. **Making the human body transparent: The impact of NMR and MRI
Research in general practice
Drugs in psychiatric practice
The MRC Common Cold Unit (1998)**
ISBN 1 86983 539 5
3. **Early heart transplant surgery in the UK (1999)***
ISBN 1 84129 007 6
4. **Haemophilia: Recent history of clinical management (1999)**
ISBN 1 84129 008 4
5. **Looking at the unborn: Historical aspects of
obstetric ultrasound (2000)**
ISBN 1 84129 011 4
6. **Post penicillin antibiotics: From acceptance to resistance? (2000)**
ISBN 1 84129 012 2
7. **Clinical research in Britain, 1950–1980 (2000)***
ISBN 1 84129 016 5
8. **Intestinal absorption (2000)***
ISBN 1 84129 017 3
9. **Neonatal intensive care (2001)**
ISBN 0 85484 076 1

*Volumes in print and freely available from Dr Carole Reeves, see page xvi.

10. **British contributions to medical research and education in Africa after the Second World War (2001)**
ISBN 0 85484 077 X
11. **Childhood asthma and beyond (2001)***
ISBN 0 85484 078 8
12. **Maternal care (2001)**
ISBN 0 85484 079 6
13. **Population-based research in south Wales: The MRC Pneumoconiosis Research Unit and the MRC Epidemiology Unit (2002)***
ISBN 0 85484 081 8
14. **Peptic ulcer: Rise and fall (2002)***
ISBN 0 85484 084 2
15. **Leukaemia (2003)***
ISBN 0 85484 087 7
16. **The MRC Applied Psychology Unit (2003)***
ISBN 0 85484 088 5
17. **Genetic testing (2003)***
ISBN 0 85484 094 X
18. **Foot and mouth disease: The 1967 outbreak and its aftermath (2003)***
ISBN 0 85484 096 6
19. **Environmental toxicology: The legacy of *Silent Spring* (2004)***
ISBN 0 85484 091 5
20. **Cystic fibrosis (2004)**
ISBN 0 85484 086 9
21. **Innovation in pain management (2004)**
ISBN 978 0 85484 097 7

22. **The Rhesus factor and disease prevention (2004)**
ISBN 978 0 85484 099 1
23. **The recent history of platelets in thrombosis and other disorders (2005)**
ISBN 978 0 85484 103 5
24. **Short-course chemotherapy for tuberculosis (2005)**
ISBN 978 0 85484 104 2
25. **Prenatal corticosteroids for reducing morbidity and mortality after preterm birth (2005)**
ISBN 978 0 85484 102 8
26. **Public health in the 1980s and 1990s: Decline and rise? (2006)**
ISBN 978 0 85484 106 6
27. **Cholesterol, atherosclerosis and coronary disease in the UK, 1950–2000 (2006)**
ISBN 978 0 85484 107 3
28. **Development of physics applied to medicine in the UK, 1945–1990 (2006)**
ISBN 978 0 85484 108 0
29. **Early development of total hip replacement (2007)**
ISBN 978 0 85484 111 0
30. **The discovery, use and impact of platinum salts as chemotherapy agents for cancer (2007)**
ISBN 978 0 85484 112 7
31. **Medical ethics education in Britain, 1963–1993 (2007)**
ISBN 978 0 85484 113 4
32. **Superbugs and superdrugs: The history of MRSA (2008)**
ISBN 978 0 85484 114 1

33. **Clinical pharmacology in the UK, c. 1950–2000: Influences and institutions (2008)**
ISBN 978 0 85484 117 2
34. **Clinical pharmacology in the UK, c. 1950–2000: Industry and regulation (2008)**
ISBN 978 0 85484 118 9
35. **The resurgence of breastfeeding, 1975–2000 (2009)**
ISBN 978 0 85484 119 6
36. **The development of sports medicine in twentieth-century Britain (2009)**
ISBN 978 0 85484 121 9
37. **History of dialysis, c. 1950–1980 (2009)**
ISBN 987 0 85484 112 6 (this volume)
38. **History of cervical cancer and the role of the human papillomavirus 1960–2000 (2009)**
ISBN 987 0 85484 123 3 (in press)
39. **Clinical genetics in Britain: Origins and development (2010)**
ISBN 987 0 85484 127 1 (in press)
40. **The medicalization of cannabis (2010)**
ISBN 987 0 85484 129 5 (in press)

All volumes are freely available online at www.ucl.ac.uk/histmed following the links to Publications/Wellcome Witnesses.

*Volumes freely available, while stocks last, from Dr Carole Reeves at: c.reeves@ucl.ac.uk

Hard copies of volumes 21–38 can be ordered from www.amazon.co.uk; www.amazon.com; and all good booksellers for £6/\$10 each plus postage, using the ISBN.

UNPUBLISHED WITNESS SEMINARS

- 1994 **The early history of renal transplantation**
- 1994 **Pneumoconiosis of coal workers**
(partially published in volume 13, *Population-based research in south Wales*)
- 1995 **Oral contraceptives**
- 2003 **Beyond the asylum: Anti-psychiatry and care in the community**
- 2003 **Thrombolysis**
(partially published in volume 27, *Cholesterol, atherosclerosis and coronary disease in the UK, 1950–2000*)
- 2007 **DNA fingerprinting**

The transcripts and records of all Witness Seminars are held in archives and manuscripts, Wellcome Library, London, at GC/253.

OTHER PUBLICATIONS

Technology transfer in Britain: The case of monoclonal antibodies

Tansey E M, Catterall P P. (1993) *Contemporary Record* **9**: 409–44.

Monoclonal antibodies: A witness seminar on contemporary medical history

Tansey E M, Catterall P P. (1994) *Medical History* **38**: 322–7.

Chronic pulmonary disease in South Wales coalmines: An eye-witness account of the MRC surveys (1937–42)

P D'Arcy Hart, edited and annotated by E M Tansey. (1998)

Social History of Medicine **11**: 459–68.

Ashes to Ashes – The history of smoking and health

Lock S P, Reynolds L A, Tansey E M. (eds) (1998) Amsterdam: Rodopi BV, 228pp. ISBN 90420 0396 0 (Hfl 125) (hardback). Reprinted 2003.

Witnessing medical history. An interview with Dr Rosemary Biggs

Professor Christine Lee and Dr Charles Rizza (interviewers). (1998)

Haemophilia **4**: 769–77.

Witnessing the Witnesses: Pitfalls and potentials of the Witness Seminar in twentieth century medicine

Tansey E M, in Doel R, Søderqvist T. (eds) (2006) *Writing Recent Science: The historiography of contemporary science, technology and medicine*. London: Routledge: 260–78.

The Witness Seminar technique in modern medical history

Tansey E M, in Cook H J, Bhattacharya S, Hardy A. (eds) (2008) *History of the Social Determinants of Health: Global Histories, Contemporary Debates*. London: Orient Longman: 279–95.

Today's medicine, tomorrow's medical history

Tansey E M, in Natvig J B, Swärd E T, Hem E. (eds) (2009) *Historier om helse (Histories about Health, in Norwegian)*. Oslo: Journal of the Norwegian Medical Association : 166–73.

INTRODUCTION

It is always a pleasure to take part in a Wellcome Witness Seminar, and this one was extra special as the fiftieth such event. Those 50 meetings are a remarkable contribution to the history of recent British medicine, one for which Tilli Tansey and her team deserve great credit.

For some of these Seminars the ‘pioneers’ are present,² but in this meeting the key figures of the late 1940s and mid-1950s were represented mainly by the recollections of their younger colleagues, now mostly in retirement. Between them, participants recreated the histories of the first dialysis machines in Britain and how they were used. It is far from a simple tale, but very instructive. The machine at the Hammersmith Hospital had been offered by its Dutch inventor, Willem (Pim) Kolff, in part because the Hammersmith was the British centre for treating ‘crush syndrome’, which had been described there during the Second World War (page 8). But the dialyzer proved less than successful: patients could not be maintained for long periods, and other methods were developed to deal with acute renal failure – methods based on diet or potassium absorption that were more in line with the postwar push towards clinical physiology as the vanguard of clinical research. In England, though not in the US, it was primarily urological surgeons who imported dialysis machines in the 1950s and used them mainly on cases of septic abortion or on patients recovering from surgical operations of such severity as would not have been attempted before the Second World War. The leading physicians who had begun to specialize in kidneys were not much interested, though some of their juniors were, especially in university departments of medicine. At Leeds, the professor of urological surgery, Leslie Pyrah, had a background in physiology; he persuaded the hospitals to buy a machine from endowment funds and he supported dialysis in part through his Medical Research Council (MRC) grant for metabolic studies, even though the MRC was deeply sceptical of medical machines (pages 12 and 36).

One of the points of contention in the seminar concerned the credit for the technical devices which from c. 1960 made chronic dialysis possible, the work of Nils Alwall, and of the Newcastle group seem to have been under-rated, but all would agree that the development of the shunt points up the huge importance of apparently simple devices and the crucial roles of new materials

² See, for example, the transcript of the Witness Seminar held on 24 September 1993, ‘Technology Transfer in Britain: The case of monoclonal antibodies’, which was attended by the late Nobel laureates Dr Georges Köhler and Dr Cesar Milstein (Tansey and Catterall (eds) (1997): 1–34).

in surgical technologies (pages 14–16). So too, the need for accurate and rapid measurement of electrolytes, for good laboratories, and for improvising new kinds of technical support. When dialysis started to become routine in the 1960s, British manufacturers took an interest, including both a major engineering firm and a specialist company, Dylade, set up by the father of Dr Stanley Shaldon, pioneer of home dialysis in the UK (pages 38–40). But as is often the case, the dialyzer market came to be dominated by US companies – which still raises questions about the role of central purchasing in the NHS.

Such technical and professional issues are becoming familiar in studies of the recent history of medicine, where simple invention stories will no longer stand up. Innovations are often incremental, different fields of patients were involved over time, professional attitudes differed between specialisms and places, and commercial power was often crucial. But this seminar also took us into more obviously social questions around home dialysis and the roles of nurses and patients. Here too, we saw both tangles of contingencies and persistent attitudes towards patient selection. At the start of the 1960s there was pressure for more dialysis centres, once chronic cases could be managed. Twenty centres were recommended in 1962, but simultaneously several of the existing centres had catastrophic outbreaks of hepatitis, that were very hard to manage before the Australia antigen tests became available, which could detect carriers of the disease. The reaction against this awful consequence of new medical technology was to limit the further development of centres, but, partly for that reason, Britain built an outstanding programme of home haemodialysis (pages 47–52).

Some of the most revealing parts of the seminar dealt with the experiences of nurses and patients as they shared with doctors the mutual education and support necessary for the maintenance of complex procedures in patients' homes. Here was an exciting and influential departure from the usual hierarchies of medicine. Telephones were crucial for providing instant advice; social workers helped to arrange for modifications of homes and assisted in complex negotiations with patients' schools and employers. One parent described her experience as 'total immersion' in the provision of dialysis for a child (page 60). Later, these programmes were much reduced, not just because kidney transplantation became more available, but because it sometimes seemed easier to deal with patients in kidney centres than to train and support them to self-dialyze.

Although the main focus of the seminar was on the UK, we also gained insights from the US and continental experiences of doctors trained in the UK. Seattle, Washington became a major US focus under Belding Scribner (the inventor of

the shunt dialysis) and Christopher Blagg who had worked under Frank Parsons at Leeds. We learned that their independent renal centre was set up to limit the financial liability of the state (pages 27–8). That centre was at the heart of US debates about explicit rationing of medical care, and provision of dialysis under Medicare – a move that led to the massive growth of a dialysis industry. In the UK, rationing of dialysis treatment was sometimes explicit, but the selection often took place below the level of hospital departments. Even now, the UK has lower rates of treatment than most advanced countries. Is that because we are collectively sensible about end of life medical expenditures, or because doctors are too ready to decide there is ‘no need’?

Throughout the seminar – from crucial technicalities to the widest issue of ethics – dialysis served as a wonderful case study. It was a privilege to see the details teased out and the narratives created. Such witness seminars do not attempt to be definitive, but they are and will remain both a major historical resource and a source of insights into the construction of histories. For this one we are much indebted to Dr John Turney of Leeds, who originated and shaped the venture, as well as to Professor Tilli Tansey and her excellent editorial team.

John Pickstone

Centre for the History of Science, Technology and Medicine,
University of Manchester

HISTORY OF DIALYSIS IN THE UK: c. 1950–1980

The transcript of a Witness Seminar held by the Wellcome Trust Centre for the History of Medicine at UCL, London, on 26 February 2008

Edited by S M Crowther, L A Reynolds and E M Tansey

HISTORY OF DIALYSIS IN THE UK: c. 1950–1980

Participants

Dr Rosemarie Baillod	Professor David Kerr
Professor Christopher Blagg	Dr Felix Konotey-Ahulu
Professor Sir Christopher Booth	Professor Monty Losowsky
Professor Stewart Cameron	Professor Sir Netar Mallick
Dr William Cattell	Dr Frank Marsh
Mr Eric Collins	Dr Jean Northover
Mrs Ann Eady	Dr Chisholm Ogg
Professor Robin Eady	Miss Lesley Pavitt
Miss Freda Ellis	Professor John Pickstone
Professor John Galloway	Dr Margaret Platts
Mrs Diana Garratt	Dr Stanley Rosen
Dr John Goldsmith	Miss Mary Selsby
Dr Roger Greenwood	Professor Stanley Shaldon
Mr David Hamilton	Dr Tilli Tansey
Dr Nicholas Hoenich	Professor Neil Turner
Mr John Hopewell	Dr John Turney (chair)

Among those attending the meeting: Professor Anthony Dayan, Dr Hedi Dayan, Mr Clifford Harvey, Miss Juliette Kingcombe

Apologies include: Professor Hugh de Wardener, Mr Paddy Hartley, Dr Arthur Hollman, Dr Mark Joeke, Mrs Dierdre Jones, Dr Ann Lambie, Professor Kenneth Lowe, Professor Sir Keith Peters, Mr Tim Proger, Professor David Thompson, Dr Anthony Wing

Dr Tilli Tansey: Ladies and gentlemen, welcome to this Witness Seminar on dialysis. My name is Tilli Tansey and I am the convenor of the Wellcome Trust's History of Twentieth Century Medicine Group. We were established in 1990 by the Wellcome Trust to bring together historians, scientists, clinicians and others interested in the history of recent medicine. One of the mechanisms devised was that of a Witness Seminar, where we get together a group of people who have been involved in a particular debate or discovery to discuss among themselves transitions in a particular subject: what happened, why and, more importantly, how? What were the factors that made some things successful and others less so?

These meetings are recorded and transcribed and will be deposited in the archives of the Wellcome Library.¹ Additionally, we aim to publish an edited transcript and any further contributions you wish to make can be added as appendices or footnotes to the transcript, and will only be published with your permission. In this way, we build up a very valuable resource, both published and unpublished, for future historians of medicine and others interested in the history of recent medicine. This is the fiftieth such Witness Seminar we have run, so it is quite an anniversary, and we are delighted to have had the suggestion of a meeting on dialysis. The subjects of all our meetings are chosen by a programme committee; we receive between 20 and 30 suggestions each year, from which we select three to four meetings to hold and dialysis was 'top of the pops' this year. We are very grateful to Dr John Turney who suggested the subject, and who is also going to chair this meeting. So, without further ado, I will hand over to John.

Dr John Turney: Thank you everybody for coming and for taking the trouble to travel some not inconsiderable distances. We are very grateful. When I started attending and later presenting papers at the Renal Association held at the UCL Institute of Child Health, the formidable front row contained several of the people here today.² Daniel had it easy, he only had to face lions. Therefore, as a cadet member of today's group, I feel I am here merely to oil the wheels of your discussion. We have a draft outline programme of which you all have a copy, but this is for guidance of direction, not restriction of scope. As Tilli has said, we are

¹ The transcript, along with the records of this meeting will be deposited in archives and manuscripts, Wellcome Library, London, at GC/253.

² The Renal Association, the professional body for nephrologists and renal scientists in the UK, was founded in 1950 and is active in planning and developing renal services and nephrology, the promotion and dissemination of research and education relating to the specialty. See www.renal.org/pages (visited 14 November 2008).

today writing an oral history of British dialysis and nephrology, and everybody here can contribute to that discussion. It is with pleasure that we welcome some distinguished historians of medicine, who will lend a historical perspective to our reminiscences, and help to guide and focus our thoughts.³

We are taking the period from the end of the Second World War to about 1980, because the 1980s saw profound changes in dialysis, with the advent of continuous ambulatory peritoneal dialysis (CAPD), the decline of home dialysis, changing patient populations, changing patterns of acute renal failure and, indeed, changing politics. If we make a satisfactory start today, if we are on our best behaviour, our hosts may consider a follow-up seminar to bring us more up to date. If we start at the beginning, we must acknowledge the postwar activities at the Hammersmith Hospital, London.

Unfortunately, some of the key participants cannot be with us today, but we have a written submission from Professor Kenneth (Ken) Lowe, with whom I have been in correspondence, and some people may be interested in his recollections of the 1940s and early 1950s at the Hammersmith.⁴ The early attempts at dialysis and the development of the conservative regimen established by Graham (later Sir Graham) Bull are the backdrop to the events of the mid-to-late 1950s.⁵ Others will talk directly or indirectly about their experiences at Leeds, Newcastle and elsewhere, as a handful of dialysis centres opened up. There may perhaps be mention of the role of the RAF, but, again, the original participants can't be with us today.

Others may wish to talk about the difficulties in learning to cope with an uncongenial technology; the numbers and types of patients, where they came from and where they had been prior to the availability of dialysis. I think we should touch on the ethics and process of patient selection and treatment withdrawal. Perhaps we should also consider the transition to a new way of practising medicine, which, after all, is what renal medicine is about, with the transfer from individuals with a machine to what we would now recognize as renal units with a multidisciplinary team with their own theatre of activity.

³ This personal, contemporary approach extends and complements recent scholarship such as Peitzman (2007).

⁴ See Appendix 1, pages 79–83.

⁵ Sir Graham Bull's conservative regimen for treatment of temporary renal failure involved control of fluid intake and diet, providing calories for nutrition with minimal waste, and isolation of the patient to prevent infection. See Bull *et al.* (1949).

What were the circumstances? Was there resistance or encouragement for this new medical technology with all that it implied?

Continuing chronologically, we will then consider the events and sequences of the 1960s revolution, precipitated by the Scribner shunt; a new disease defined by its technology; a new way of working; new problems presented by the technology; and by the fact that patients were now living beyond the point at which, without intervention, they would have died. I am sure we will consider hepatitis, aluminium and cardiovascular disease, among other problems.

There were also problems of identifying, enumerating and selecting patients, the demands they put upon resources, and how these demands were met. This was the dawn of the political era of nephrology. The end-stage renal failure services were to remain contentious, not only in terms of finance, and overt and covert rationing, but also in terms of the clinical and ethical problems of starting, maintaining and ending treatment. I see the 1970s as a period when the pattern of renal services had settled somewhat, but it was a period of pushing the boundaries of the treatment. Doubtless our reminiscences will continue to centre on politics and resources, medical and psychological complications, the role and influence of commerce, and perhaps, the disappearance of British industry, changing roles of the members of the renal team, the patient population and its gradual empowerment with the rise and subsequent fall of that very British phenomenon, home dialysis. Doubtless too our conversation will move backwards and forwards in time as we follow themes. I don't think that we should be constrained by period, place or subject. So that's a little bit of the setting for this afternoon and it's a great pleasure to introduce John Pickstone, Wellcome professor of the history of medicine at Manchester, who will give a historian's perspective to our discussion.

Professor John Pickstone: It's a great pleasure to be here, and thank you for the invitation. May I also congratulate Tilli on 50 Witness Seminars, no mean achievement.

Most of what I know about dialysis is from working with John Turney, but I have researched other technologies and other aspects of the health service. John asked me if I would give a few introductory remarks, chiefly to point to the fact that this is not just a history for those who lived it. It's a history that is important for lots of people who are concerned with the relationships between medicine and society and particularly how these developed in the postwar UK.

So, five brief points: one, of course, is that we should try to see things in context as far as possible, without the aid of that wonderful instrument – the

retrospectroscope. The great art is to recall and recreate what the problem was *then*, how it looked *then* and not to use later wisdom. And *then*, of course, was the postwar UK, which, as John has noted, was economically constrained.⁶ There wasn't much spare money for new hospitals or new facilities. On the other hand, one had seen a step-change in the funding for medical research and for salaries for hospital consultants.⁷ Many of the things that the Medical Research Council (MRC) had wanted to do during the interwar period were becoming possible in the postwar world through salaried consultancies, more drugs and more academic units. That context was undoubtedly very creative, as one knows also from work on artificial hips, or on cataract operations.⁸

My second point is to underline the importance of what one might call communities of practice and the different ways in which people approach things. Clearly, one of the strongest aspects of British clinical medicine after the Second World War was what might be called clinical physiology, at the Hammersmith Hospital, London, but also nephrology in Manchester, with a great concern for analysing conditions, often using techniques that had been developed in physiology labs.⁹ Another aspect was the concern with diets and other forms of regimen. When one is talking about the contrasts between diet and technology, it is again important to try to get that into context. It's easy to see diet as something very old, and technology as something essentially modern, but many of these diets were worked out by clinical physiologists, who thought that they could deduce them from their physiological results.¹⁰ That was exciting, that was an application of science, even if it wasn't made out of metal or plastic.

I would also emphasize the contrast between that community of laboratory, analytical physicians and the surgeons, who were also benefiting from the increasing funding under the NHS, but had very different research traditions.¹¹ If you think of the industrial model of research-and-development, surgery is much more like development than research: it's about trying things which

⁶ Hennessy (1994).

⁷ Hardy and Tansey (2006): 406, 417–22.

⁸ See, for example, the introduction by Francis Neary and John Pickstone to Reynolds and Tansey (eds) (2006): xxv–xxix; Anderson *et al.* (2007).

⁹ See Booth (1993).

¹⁰ See McCance and Widdowson (1939).

¹¹ See Booth (1993).

are very difficult to predict in principle, and building on that experience in a step-by-step process. One of the key issues with dialysis is the division of labour between surgeons and physicians and, to some extent, the emergence of physicians followed on from techniques. In the US, what you might call operative physicians, or technical physicians, became largely separate from other kinds of nephrologists. One sees that same tension in cardiology, which is an obvious comparison for nephrology, where some cardiologists became particularly interested in pacemakers and catheters, and to some extent in some contexts, this became a kind of sub-specialism.¹²

But that's moving on a bit. If we switch back to discussing the beginnings of dialysis, my fourth point is that one must ask what the technology was for at the time. The technology one knows later for chronic conditions was initially practised on acute renal failure.¹³ What was acute renal failure? It's something said to have been discovered through trauma injuries in the Second World War, but once the war had ended there were far fewer of these trauma injuries. So, what then was the population with acute renal failure? And who in a hospital would know enough about the relevant obstetric conditions (e.g. septic abortions) to be able to link them with trauma and other conditions?¹⁴ Clearly the definition of that target population is partly a question of who knows these various groups, and can bring them together. As John Turney said, it was also a consequence of other technical developments, because patients who would have died quickly a few years earlier were not dying so quickly. They could be said to have acute renal failure and some of them recovered anyway. How could you help them through that? And how could new types of patients, with surgical trauma or inappropriate blood transfusions, also be 'framed' together and treated for 'acute renal failure'?

The last point is about how we make comparisons, especially between countries. It's too easy to compare the place where things take off, which is usually the US, with the UK, and then to start looking for systematic differences between countries, for example, in general attitudes with respect to techniques. That approach always needs interrogating. One needs to ask just how many innovative places there were in the US, and how many places were 'conservative'. If you mapped it out, would the countries really look so very different? Is this really

¹² See Bynum *et al.* (eds) (1985).

¹³ See page 17.

¹⁴ See, for example, Bull *et al.* (1955; 1956) and page 18.

a question of national differences or is it something that should be explored through local differences and professional differences within countries, more than between them?

Those are just five pointers to issues around this technology. I hope that that is helpful, but I am very much looking forward to learning the innards of the story from you.

Turney: We need to start at the beginning and we need a volunteer to start.

Professor Sir Christopher Booth: Perhaps I could give my background. I went to the Hammersmith Hospital in 1952. I was Malcolm Milne's registrar in renal disease at the Hammersmith between 1956 and 1957 and I knew Ken Lowe, because he went to Dundee just when I finished my time there in medical training at St Andrews. What happened at the Hammersmith, basically, was that it became the referral centre for acute renal failure, because of the crush syndrome work that Eric Bywaters had done in the early years of the war.¹⁵ This was at a time when the crush injuries were sent to peripheral hospitals in London and not, obviously, to central ones, because they were late casualties. That work went well, and in 1945, as soon as the war was over, Bywaters legged it to the Netherlands and got an artificial kidney from Willem Johan (Pim) Kolff (Figure 1) and brought it back to the Hammersmith and Ken Lowe can remember using that kidney.¹⁶ He got very tired simply watching this rotating drum going round and round and round, and they didn't have very good results. That resulted in Graham Bull, who was Bywaters' successor as head of renal medicine at the Hammersmith, introducing his conservative regimen for the management of acute renal failure.¹⁷ That worked well; then he went off to Belfast and was succeeded in 1952 by Milne.¹⁸

Milne had no interest in dialysis whatever, he was a biochemist, but we still got cases with acute renal failure; they used to fly into the playing field next door to

¹⁵ See, for example, Bywaters and Beall (1941); see also Bywaters (1990); Dixon (2003).

¹⁶ Professor Christopher Blagg wrote: 'The artificial kidney used by Ken Lowe was one of four donated at the end of the war by Pim Kolff who had hidden them in 1944. They were sent to Bywaters and Joekes at the Hammersmith, Poland (this one ended up in Jagiello University in Cracow but apparently was never used), the Royal Victoria Hospital in Montreal, and Isidore Snapper at Mount Sinai Hospital in New York; see Broers (2007): 111–13.' E-mail to Ms Stefania Crowther, 8 July 2009.

¹⁷ See Bull *et al.* (1953) and note 5.

¹⁸ See Peart (1995).

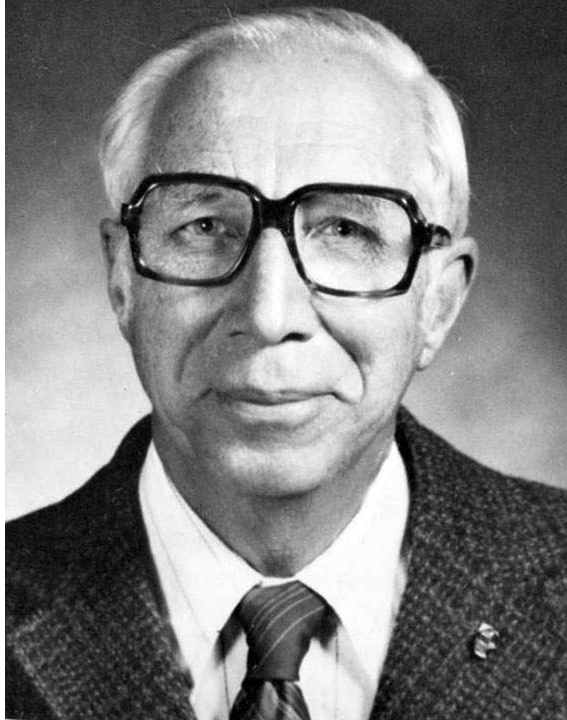

Figure 1: Willem (Pim) Kolff (1911–2009).

the Hammersmith in air ambulances and we would be landed with somebody in acute renal failure. The major problem then was potassium – the patients died of hyperpotassaemia. So Milne's first work at the Hammersmith was to work on the potassium-binding resins, which were just coming in at that time.¹⁹ He did some very good work on that and we were able to save patients in acute renal failure by using those regimens.

What happened next was that Belding Scribner (Figure 2) arrived at the Hammersmith.²⁰ Scribner came as a research fellow with Milne, and my first experience of Scribner was seeing a great big round green glass bottle in a packing case in a hallway at the Hammersmith in the middle of 1956 with Scribner's name on it. I had never heard of Scribner before. He came to dialyze via the stomach, gastrodialysis, with Milne. The reason he came to the Hammersmith was that it was a centre for referral for acute renal failure. It was he, I think, who basically pushed the idea that dialysis wasn't a bad idea at all.

¹⁹ See, for example, Black and Milne (1952).

²⁰ See Blagg (2006).

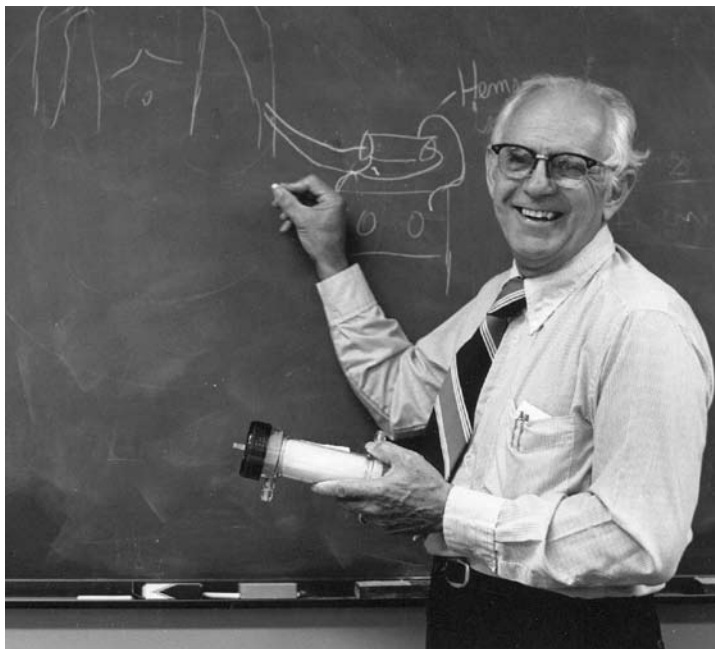

Figure 2: Belding Scribner (1921–2003).

Then, in the spring of 1957, Milne and Professor Ralph Shackman, a urologist at the Hammersmith, brought back a rotating drum kidney from Paris.²¹ I remember having to use that at the Hammersmith in the middle of 1957. We used to sit beside this great big beautiful stainless steel rotating drum and people would put their heads round the corner and say: ‘Frying tonight?’ But, I remember, it was something, of course, that was developed at the Hammersmith in surgery, not in medicine. The paper that Milne, Scribner and Crawford wrote while Scribner was there was published in the *American Journal of Medicine* in 1958 and got a ‘citation classic’ in 1981.²² It was on non-ionic diffusion, which was Milne’s major interest in life and led on to his work on Hartnup disease and cystinuria.²³ Milne stood aside completely, happy for his registrars to go along

²¹ Professor Stewart Cameron wrote: ‘This was the French “Usifroid” modification of the Kolff–Brigham version of the rotating drum dialyzer.’ Note on draft transcript, 18 July 2008. Professor Christopher Blagg wrote: ‘The Usifroid Necker Hospital version of the Kolff–Brigham rotating drum artificial kidney was made by the Société Usifroid Paris about 1955 and was the one used by Ralph Shackman at the Hammersmith when he started the programme in late 1956.’ Note on draft transcript, 8 July 2009. See Appendix I, pages 79–83.

²² Milne *et al.* (1958); Milne *et al.* (1981).

²³ See, for example, Milne (1969); Colliss *et al.* (1963); Milne (1967).



Figure 3: Frank Parsons (1925–89).

and help the surgeons. It was Shackman who developed dialysis, and that's why it developed the way it did.²⁴

Professor Christopher Blagg: I'm originally from Leeds, now in Seattle. I first came back from the army in January 1958 to Leeds, where dialysis for acute renal failure had started in September 1956 with Frank Parsons (Figure 3) and Brian McCracken.²⁵ If you read Stewart Cameron's book you will know more about how this came about.²⁶ Again, it was the surgeons. The professor of urologic surgery at Leeds, Leslie Pyrah, had invited Charles Huggins from Chicago to come and give a talk at the British Urological Association meeting, and as a 'thank you' for this, Huggins arranged for Frank to go to Chicago for a year, in 1953/4, to do cancer research.²⁷ Frank took the last three months to go to Boston, to the Peter Bent Brigham Hospital, to John Merrill to see how

²⁴ Shackman and Milne (1957).

²⁵ Parsons and McCracken (1957; 1959), Hamilton (1984).

²⁶ Cameron (2002): 124–5.

²⁷ For Frank Parsons' account of these events and early dialysis at the University of Leeds, see Parsons (1989).

acute renal failures were being treated.²⁸ He came back to Leeds and, again, it was through the efforts of Mr Pyrah that they persuaded the Leeds General Infirmary to buy an artificial kidney, the Kolff–Brigham version of the rotating drum kidney (see an example of the type in Figure 4).

On his return Frank had been appointed assistant director of the MRC unit for metabolic disturbances in surgery, Leeds General Infirmary, under Pyrah and, while the machine was in the mid-Atlantic, he was called down to the MRC for an urgent meeting, which lasted for about two hours, during the course of which he was told that there was no future for an artificial kidney in the UK, it was a mere gadget and that was the view of the MRC advisers. The parting words to Frank from Sir Harold Himsworth after the meeting were along the lines of: ‘Parsons, try it, but remember the country is against you.’ But they couldn’t say, ‘No’, because the infirmary had already bought the artificial kidney.²⁹

So, the programme started and it was a joint affair between the department of urologic surgery and the department of medicine, supported by Mr Pyrah and Professor Ronald (later Sir Ronald) Tunbridge and housed in the hospital’s new metabolic ward. As I think we will see later, in terms of what went on, it was just like the advent of chronic dialysis: the ‘establishment’ of renophiles in those days was totally against the idea and was unimpressed. So, for the first year or so, there were only the units at Leeds and at the Hammersmith Hospital and then, in 1957, Wing Commander Ralph (later Sir Ralph) Jackson started the unit at RAF Halton.³⁰ Those are the beginnings of the process.

Mr John Hopewell: Glasgow acquired a Kolff drum kidney in 1958. Did anything happen in Glasgow at that time?³¹ Sir Ralph Jackson gave many of us a lot of help in the early years. The late and revered Mary (Mollie) McGeown

²⁸ See, for example, Merrill (1952).

²⁹ Parsons (1989): 1559; see also Hamilton (1984): 92–3.

³⁰ The RAF Hospital, Halton, was opened in 1927 and acquired a Kolff–Travenol type artificial kidney in late 1957. See Jackson (1958); Robson and Dudley (1958). See also www.raf.mod.uk/rafhalton/aboutus/history.cfm (visited 14 October 2008). Early work on the theory of analysis from the Halton group can be found in Blackmore and Elder (1961).

³¹ Professor Christopher Blagg wrote: ‘Arthur Kennedy, senior lecturer in medicine in the artificial kidney unit at Glasgow Royal Infirmary, came to Leeds in 1958 and we taught him about the use of the artificial kidney. They started up using an Usifroid rotating drum kidney, rather than a Kolff twin-coil kidney.’ Note on draft transcript, 8 July 2009. See Kennedy *et al.* (1961).

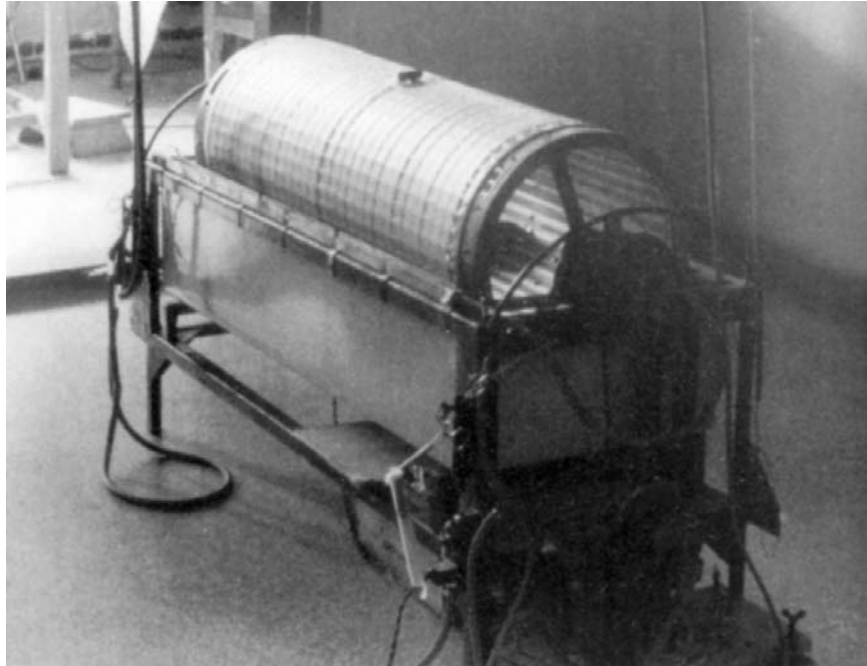

Figure 4: Kolff and Berk's first artificial kidney with a drum of aluminium slats and a static open dialysate bath, 1942.

came to London in 1958 and looked at the drum kidney at the Hammersmith and subsequently went to RAF Halton and chose to buy a twin-coil kidney, which Ralph Jackson was using at Halton.³² But I would like to hear what became of the RAF unit at Halton. You say it began in 1957. They were using that when I went to see Ralph in 1958. What became of it? I have applied to the RAF, but I can't get anywhere, so far.

Turney: Certainly Jackson and colleagues from the RAF did publish on what they called a mini-coil in the late 1950s.³³ Perhaps Stewart can answer those questions?³⁴

Professor Stanley Shaldon: Perhaps I could intervene before we move on. There are a few historical inaccuracies, which I personally would like to correct. I think

³² Douglas (1998); Cameron (2000a).

³³ Jackson (1958); Jackson *et al.* (1960). Professor Stewart Cameron wrote: 'The "mini coil" was introduced by the Birmingham group in about 1963/4. See Cameron (2002): 160.' Note on draft transcript, 18 July 2008.

³⁴ Professor Stewart Cameron wrote: 'The Halton unit functioned until the late 1970s or the mid-1980s, I think.' Note on draft transcript, 18 July 2008.

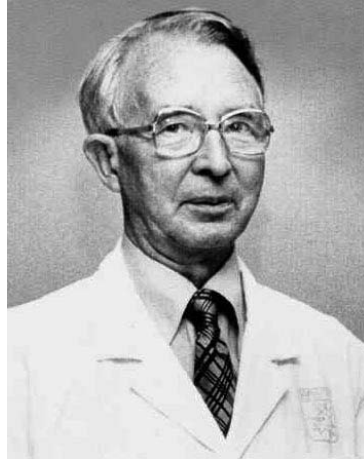

Figure 5: Left: Professor Nils Allwall.

the tribute for the arteriovenous shunt belongs to Professor Nils Allwall (Figure 5).³⁵ Scribner acknowledges this quite clearly in his first publication in 1960.³⁶

Turney: But it wasn't a workable shunt.

Shaldon: Excuse me, it worked very well. If you read his book he has 1500 cases treated with his shunt, and it was glass.³⁷ What it didn't do and neither did the original Scribner shunt – and this I can tell you from personal experience – was last. Scribner and Quinton's had a rigid Teflon device which lasted approximately

³⁵ Professor Stanley Shaldon wrote: 'In 1964, when the European Dialysis and Transplant Association was set up, I was a council member and Allwall was also on the council. During this time I became friendly with Allwall and he visited the National Kidney Centre in London in 1968/9 when I was working there, and gave me a personal copy of his book. Allwall was most interested in ultrafiltration. Indeed he named his artificial kidney the ultrafiltrator. He was responsible for treating many patients with congestive cardiac failure and ascites by ultrafiltration and indeed Kiil (who developed the first passive flow pumpless purpose designed artificial kidney in 1960, which became the routine dialyzer used by Scribner after he abandoned the Skeggs-Leonard kidney) quotes Allwall as his source of design to permit ultrafiltration.' E-mail to Ms Stefania Crowther, 21 July 2009.

³⁶ Quinton *et al.* (1960).

³⁷ Allwall (1963); see also Shaldon (2006). Allwall presented his findings in a paper entitled: 'Fifteen hundred treatments with the artificial kidney (dialysis and ultrafiltration)', at the First International Congress of Nephrology in September 1960. Professor Christopher Blagg wrote: 'Allwall's original experimental shunts in rabbits used glass cannulas that functioned for a week or so and he then used various modifications of these both in rabbits and in patients, but in his book he says he "abandoned the use of arteriovenous shunt or any other permanent cannulation, because of local infection and the difficulty of avoiding blood-clotting in a satisfactory way by heparinization" and does not say when he stopped using the shunt or how many patients he did not use the shunt in. (Allwall (1963)).' Note on draft transcript, 14 July 2009.

six weeks, and if it hadn't been for Wayne Quinton introducing a silicon rubber loop, there probably wouldn't have been chronic dialysis successfully working anywhere in the world (Figure 6).³⁸ So if we are going to recount history, let's get it right. It was Alwall who invented the first shunt, a man not recognized outside of David Kerr's unit in Newcastle, which had an Alwall artificial kidney. When I was Sheila Sherlock's houseman in 1957, I first saw a patient die in the Hammersmith from cerebral oedema because the Kolff rotating drum had no means of ultrafiltrating. Indeed, before they could measure sodium correctly, which was mainly due to Merrill and the flame photometer, their kidney was thrown out of the Netherlands and Bull came in with the conservative regimen.³⁹ So, I think the perspective needs to be tightened a little on one's recollections of this. Basically, Alwall is a neglected figure in the history of European dialysis, but he invented a shunt and he had patients living on chronic repetitive dialysis long before Scribner. Scribner acknowledged this.⁴⁰

³⁸ Scribner *et al.* (1960); Quinton *et al.* (1960). See also Clark and Parsons (1966). Hegstrom *et al.* (1961) concluded: 'If cannulas are to last for long periods, care must be used during the cannulation procedure to make them mechanically perfect.' Professor Christopher Blagg wrote: 'Not everyone realized how true this was. In fact, the next article in the same journal described in great detail the problems with the Teflon shunt, some modifications to this and the first attempts to introduce silastic rubber tubing into the shunt to reduce its rigidity. (Nakamoto *et al.* (1961)) However, although silastic had been reported to retard clotting even better than Teflon, in the shunt it invariably clotted, see Quinton *et al.* (1961). Quinton went on to develop silastic tubing with an improved surface finish that did not cause clotting and improved cannula survival so that the silastic-Teflon arteriovenous cannula became the standard blood access device prior to the fistula. A paper from the Seattle Artificial Kidney Center in 1966 discusses cannula management in detail (Pendras and Smith (1966)).' Note on draft transcript, 8 July 2009.

³⁹ See note 5.

⁴⁰ Professor Stewart Cameron wrote: 'Clearly, in terms of public knowledge and acceptance, Scribner and Quinton made the breakthrough, with restoration of dying uraemics to relative health, even if Alwall first had the idea more than a decade previously. Scribner always denied he knew of Alwall's work to begin with, saying to me (and to others) that if he had known of Alwall's failure, he would probably not have tried the idea. Their first paper, however, quotes Alwall's experiments (Scribner *et al.* (1960)). At the 1960 International Congress of Nephrology meeting in Evian, France, Alwall mentioned in discussion a patient who was oligo-anuric for seven months on dialysis and survived...Alwall virtually never comments on access, and in no patient's death was inability to get access the reason – although poor blood flow is mentioned from time to time. This success may be because he used glass stoppers for his indwelling glass cannulas, which he left in place with heparinization. I – and I suspect many others – still used this simple technology (but without the glass stoppers) as late as 1962/3 for acute renal failure, even though the Teflon shunt had already been described and used and its application to acute as well as chronic renal failure suggested by Geoff Chisholm in Edinburgh in 1961 (Chisholm (1961)).' Letter to Ms Stefania Crowther, 11 July 2009. Professor Stanley Shaldon wrote: 'I wish to disagree with Professor Cameron, I remember very well that I heard Alwall describe the glass cannula shunt he had used to perform haemodialysis and indicated that he had reused these cannulas on several occasions by keeping the circulation running through the cannulas with a glass bridge to keep the access site open.' E-mail to Ms Stefania Crowther, 21 July 2009.

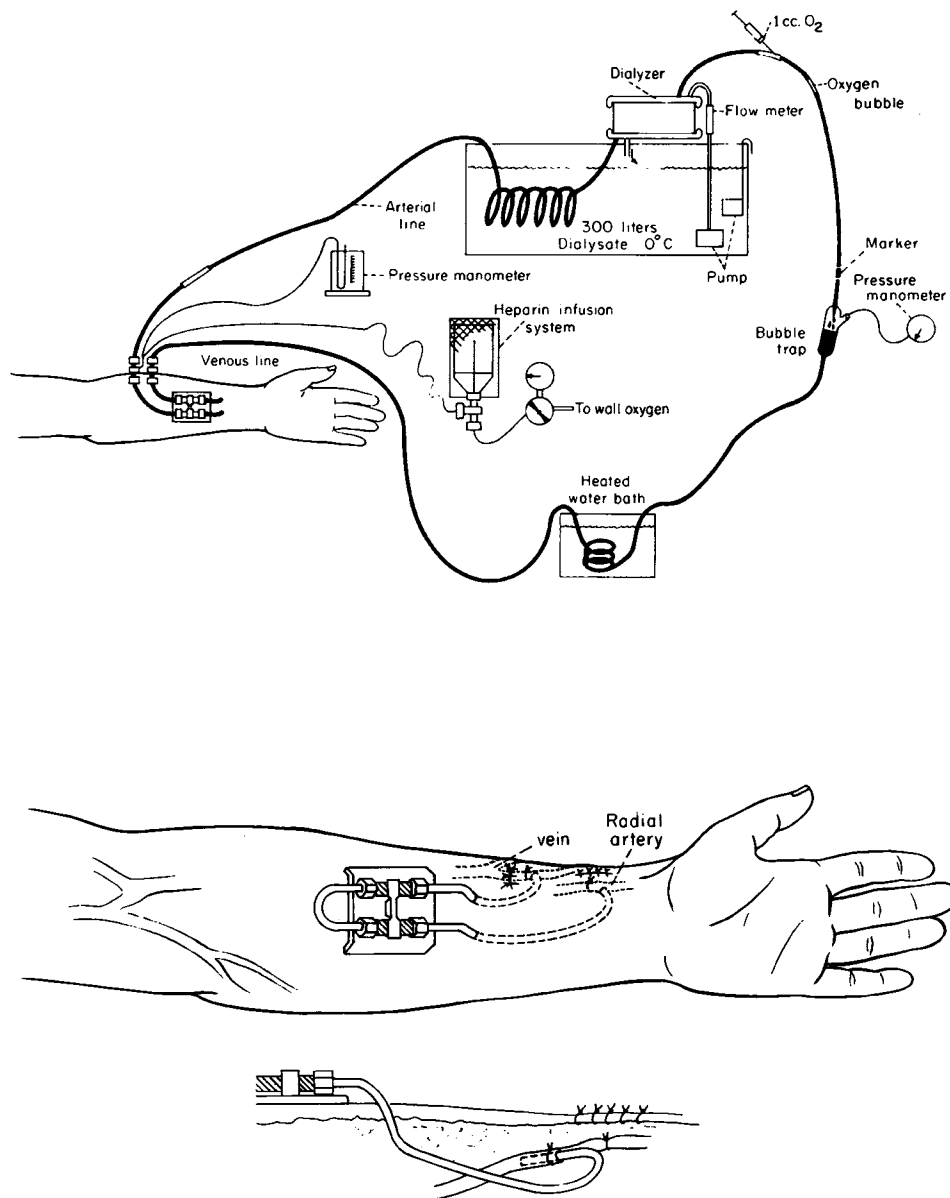

Figure 6: Top: Diagram of the technique of continuous haemodialysis.

Adapted from Scribner *et al.* (1960).

Bottom: Arm plate and cannulas in place for long-term cannulation of arteries and veins.

Adapted from Quinton *et al.* (1960).

Turney: I take your point, Stanley. It is well made. We are thinking about dialysis in the UK primarily. The revolution that was precipitated by Scribner was his presentation at the annual meeting of the American Society for Artificial Internal Organs (ASAIO) in Chicago in 1960 and the shunt and building up the whole concept of the management of chronic renal failure.⁴¹ I merely used that as a pivotal date.

Shaldon: I think that's anecdotal. It's just Anglo-Saxon arrogance, if you don't mind the word.

Professor Stewart Cameron: I certainly would support Stanley in his eulogy of Nils Alwall, who was an extraordinary person, technologist, and clinical nephrologist, and who, in addition to the list of things Stanley mentioned, also introduced renal biopsy. This is often forgotten and only because he tried to biopsy somebody with a single kidney and lost that patient did he not publish his results in 1944, long before Iversen and Brun, and Muehrcke and Kark did ten years later.⁴²

Just a few points about the start of our retrospective history, because, unfortunately, we don't have the individuals involved here to give us the primary evidence. Some of them are around, such as A M (Jo) Joekes.⁴³ A point about the beginnings of dialysis: both Nils Alwall and Pim Kolff have always emphasized that they started off with the idea of treating chronic renal failure. At that time acute renal failure wasn't much on the horizon; the term didn't exist in the early 1940s. There were various people who had suffered various forms of acute renal failure, but the general concept of acute renal failure didn't exist really until the later 1940s when it first started being used, around 1948/9.⁴⁴ Interestingly enough, one of the first people to use it in the sense that we do today was Homer Smith, a physiologist, not a clinician, in his book on the kidney, published in 1951 by Oxford University Press.⁴⁵ And so, I think, the two medical pioneers in this area, Alwall and Kolff, started off with the idea of treating chronic renal failure.

⁴¹ Dr John Turney wrote: 'ASAIO remained for years the main forum for dialysis in the US.' Note on draft transcript, 10 July 2009.

⁴² Iversen and Brun (1951); Kark and Muehrcke (1954).

⁴³ Dr Joekes was unable to attend the Witness Seminar on 26 February 2008.

⁴⁴ See Cameron (2002): 110–19.

⁴⁵ Smith (1951).

I would also like to second what was said about the heavy involvement of surgery and, of course, urology in particular, in the introduction of dialysis, not only internationally, but within the UK. If you tot up the dialysis units that began in the urological department or were heavily supported by a urological department, or primarily used by the urological department, you deal with almost all of the British units.⁴⁶ The one exception to this trend was the US. The urologists in the US didn't want to know. The few that did dialyze used peritoneal dialysis – it's an interesting anomaly, perhaps not relevant to our discussion today.⁴⁷

It then came to be realized that long-term support of patients was not possible and acute renal failure, as it were, tiptoed sideways towards centre-stage in dialysis, but it was undoubtedly a secondary development. It's interesting that there were a lot of acute renal failure patients around in the 1940s, mainly from mismatched transfusions because they were still sorting out blood groups,⁴⁸ and from septic abortions.⁴⁹ This latter group persisted longer in some of the countries where legislation or custom was perhaps less permissive, particularly in the Catholic countries, if one wants to be controversial. France, for example, continued to have patients with acute renal failure from septic abortions long after they had, perhaps not disappeared, but certainly become only a minor feature of the British landscape.⁵⁰ So, if you like, the 'easy-to-treat' patients with acute renal failure did well on the conservative regimens of the late 1940s particularly pioneered at the Hammersmith, but elsewhere also, in the Netherlands, for example, as we have heard, by Gerd Borst.⁵¹ However, the surgeons were simultaneously beginning to 'create' more and more patients who needed acute dialysis because they had traumatic acute renal failure, not accidental trauma in fit young people, but much more deliberate trauma, often in rather ill people. The result was that these catabolic patients simply could not be managed conservatively and so one swung back to the idea that dialysis was a good idea, after it had been abandoned by almost everyone, even including people like Merrill. Just read what they were writing: Arthur Grollman, pioneer of peritoneal dialysis, what

⁴⁶ Cameron (2002): 124–5.

⁴⁷ Cameron (2002): 134.

⁴⁸ Cameron (2002): 111; Diamond (1980).

⁴⁹ See, for example, Bull *et al.* (1956).

⁵⁰ Richet (1999).

⁵¹ Borst (1948).

was he saying in 1950?⁵² John Merrill, pioneer of haemodialysis, what was he saying in 1950?⁵³ They said that dialysis is unnecessary and probably doesn't work in the type of patient that they particularly saw at that time. I suspect that in the UK we had our own limb of that debate, which involved people like Eric Bywaters and Jo Joekes, who together did the first dialysis in the UK.⁵⁴ It is worth remembering that they were actually only the third group in the world to do haemodialysis, after Alwall and Kolff. They were ahead of Murray in Canada by a few weeks, and ahead of everybody else.⁵⁵ Also, I think I must put in a word for Michael Darmady, as I have written about him recently and I would refer you to the paper in *Nephrology Dialysis Transplantation*.⁵⁶ Darmady did a huge amount, including building his own flame photometer in 1947 or 1948 before any were available commercially. This group of people all did dialysis, but became disillusioned with it. When I interviewed Jo Joekes a few years ago for the International Society of Nephrology series of videotape recordings, I asked him what he actually felt himself at that time about conservative versus active treatment; he said that in 1950 he definitely supported the idea of conservative treatment and didn't see a future for dialysis.⁵⁷ But to answer one of the other questions, it was Joekes who later got on to Kolff, who, with Bruno Watschinger from Austria, then with Kolff in the US, had developed a disposable twin-coil kidney.⁵⁸ It hadn't even been published at that time, Jo told us in that interview (which by the way is available on the web). He decided to get one of the 'earliest twin-coils', and it was he who was responsible for advising the RAF to have a twin-coil kidney.

Back to Guy's Hospital, London: Alwall visited Guy's in 1948 and dialyzed a patient with chronic renal failure with polycystic disease in the private wing with one of his own artificial kidneys.⁵⁹ This dialysis had no impact on the

⁵² See Muirhead *et al.* (1949); Grollman (1951); Grollman *et al.* (1951). See also Cameron (2002): 115.

⁵³ Merrill *et al.* (1950).

⁵⁴ See Bywaters and Joekes (1948).

⁵⁵ See McKellar (1999; 2003).

⁵⁶ Cameron (2007).

⁵⁷ A transcript of this interview is available online at <http://cybernephrology.ualberta.ca/isn/vlp/Trans/Joekes.htm> (visited 18 March 2009).

⁵⁸ Kolff and Watschinger (1956).

⁵⁹ Windschauer (1948).

desperate attempts of the nephrologist of the time, Arnold Osman, to start up a dialysis and renal unit at Guy's, but Osman stayed down at Pembury Hospital in Kent.⁶⁰

Dr Frank Marsh: I was a student at the London Hospital in the late 1950s and acute haemodialysis there started in 1958 or 1959 with the Kolff twin-coil kidney, run by a chap called Richard (Dickie) Balme, who is now forgotten in nephrological circles. He later became a gastroenterologist and later still a geriatrician. He was senior lecturer on the medical unit and ran the Kolff twin-coil together with David Ritchie, senior lecturer on the surgical unit, who was appointed professor of surgery at the London Hospital Medical College in 1964. There appears to have been a bit of a battle royal between the surgeons and the physicians as to who should run it after the 1950s, and the physicians won. I remember vividly sitting over the Kolff twin-coil, whose coil was liable to break at any moment and spew blood into the bath. There were virtually no monitors on it and I remember sitting rather sleepily looking after an acute dialysis patient, looking at a trickle of yellow material coming down a tube which went into the blood line and realizing to my horror that in fact it was oil from a manometer.

Dickie Balme, incidentally, also introduced peritoneal dialysis in the late 1950s, which was from a great big glass bottle. The London Hospital continued to use the Kolff twin-coil for acute dialysis until it started chronic haemodialysis with the Kiil flat plate kidney in 1965 (Figure 7),⁶¹ and in 1968 opened the first haemodialysis unit financed by the then Ministry of Health,⁶² which is another story.

Turney: Professor Kerr, you built an Alwall kidney?

Professor David Kerr: The Alwall was used first in Newcastle by Professor George Smart, a marvellous chap and the person who actually made the north of England a good place to go to, and that is why I was there. He was a wonderful man and brought in people from all parts of Europe, as well as the UK and from many

⁶⁰ Staff from Guy's Hospital were divided up and relocated to hospitals in Kent during the Second World War. Osman chose to remain at Pembury Hospital to establish a renal unit there in 1944. See Cameron (1997).

⁶¹ The Kiil flat plate kidney was introduced in 1960 by the Norwegian surgeon, Dr Fredrick Kiil. See Kiil (1960). Professor Robin Eady wrote: 'The Kiil dialyzers consisted of a stack of three heavy slabs, or boards, of polypropylene, enclosing two layers of cellophane sheets that acted as dialysis membranes. These sheets were soaked in a sterilizing solution and, while still wet, were applied in pairs to the grooved surfaces of the boards, a two-person task. The artificial kidney then was tested for leaks by pumping air between the membranes noting any drop in pressure.' Eady (2001): 24.

⁶² See Dathan *et al.* (1970).

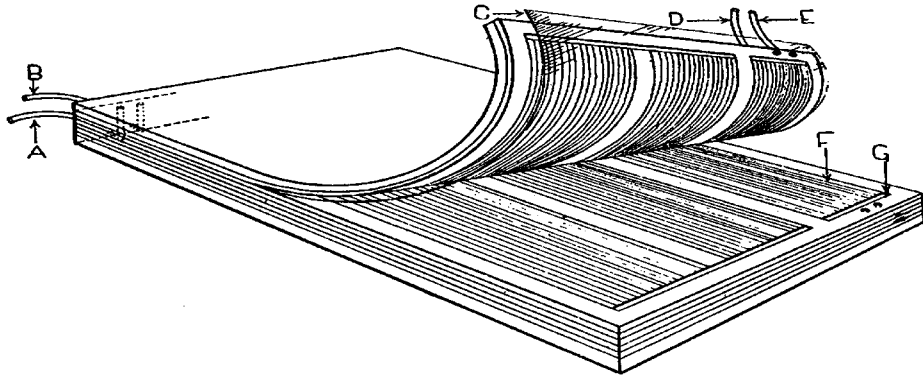

Figure 7: Flat plate kidney using Kiil membranes, c. 1965.

Above: Diagram of a continuous dialyzer adapted from Skeggs and Leonards (1948):

‘The top rubber pad has been bent back to show the relative position of the Cellophane (C) and the fine grooves (F) in the bottom rubber pad (G). A, B, D, E are inlet and outlet tubes for blood and dialyzing solution.’

Below left: soaking membranes. Below right: stretching membranes.



parts of the world. When I came to join him I spent a lot of time going round the world being looked after by friends of his. When I first came to see him, in 1959, he was using the Alwall kidney because among his friends he had the people across the North Sea in Sweden. So when he spoke to his friend Professor Alwall he got an Alwall kidney. When it was brought to Newcastle he had three people with him who helped him: Molly Hall, Walter Elliot and John Swinney, and three days later I was going to become the person to run the renal unit. They started with this and everything went wrong. The Alwall dialyzer consisted of two cylinders around which the blood was passed.⁶³ Every time they did it, it started bleeding out. This went on for 36 hours with three people trying to do it and then finally the penny dropped: there must be some little bits on the side of it, which were breaking the cellophane. And so they called the dental chap, who came up and went over it, and found two little bits of stuff that was making holes. They were all standing on their feet but not using their minds. Anyway, they got it the thirty-first time, and it worked. I was on the way up to Newcastle that day; when I arrived Professor Smart had come to see what was going on and he pointed out that the blood wasn't coming along. Of course, the people who hadn't been to sleep for 36 hours had forgotten the heparin.⁶⁴ Fortunately, the lady who was being treated was getting better and she started to pass urine normally. When I came to chat with her she said: 'Oh, it's wonderful that you have used this lovely machine and I got better.' And I said: 'Yes, yes, yes.' This was in 1959; after that the artificial kidney worked perfectly well for the next year that we used it.⁶⁵

Dr Rosemarie Baillod: I want to continue Frank Marsh's observations on seeing dialysis as a student at the same time, in 1959. I remember going to see the Royal Free Hospital's twin-coil kidney. I was not interested in the machine as my eye was taken by a lady who was weighing salts using laboratory scales. She was measuring the chemicals to make up the dialysate fluid. Nobody has mentioned that you could not do dialysis without a biochemist. I don't know whether all departments had access to biochemistry at this time and whether this presented difficulties.

Turney: I think that's a very good point. The flame photometer has been mentioned and Kolff, of course, had access to a flame photometer. In Leeds, rapid, accurate biochemistry was key.

⁶³ See Cameron (2002): 88–9; Maher (1989): 35.

⁶⁴ The anticoagulant heparin is still used in dialysis. See pages 44–5.

⁶⁵ See Hall *et al.* (1961).

Blagg: We didn't have a biochemistry department in Leeds. We had Frank Parsons, who had done this, I think, when he stayed in Boston, and I think he built his own flame photometer when he got back, but there was not a separate lab.

Turney: I think he got an Eel prototype from Cambridge.

Professor Sir Netar Mallick: To reflect on the fact that there were nephrologists in the country at that time, as John Pickstone said, we had Sir Robert Platt (Baron Platt of Grindleford from 1967) in Manchester, who took distinctly no interest in the early history of these sorts of techniques as far as I could see. I was houseman on the urology unit in late 1960 to early 1961, when Platt was gifted a twin-coil kidney, which he promptly re-gifted to the urologists. As a houseman I was privileged to see this work and Platt, the very distinguished nephrologist, turned up about once a week to see what was going on. But it's interesting to see how much the urologists really got it going here and how this highly intellectual group of physicians who were pushing renal medicine through the frontiers did not see dialysis as being at that level.

Mr David Hamilton: I think we should get the flame photometer story clear, because it is a very crucial part of the history. Before that, could I urge the meeting to use a standard terminology about regime or regimen? Frank Parsons always insisted it was to be called regimen. Regime is: 'we have seized the radio station and put a new government in.'

More seriously, Dr Kolff clearly acknowledged Mr Ruud Domingo, who lived across the road from him in Kampen, Netherlands. Domingo was charged with clearing or assisting the biochemical studies of reclaiming the Dutch polders after flooding and measuring the salt and chloride exit from the flooded polders. He had no uranyl acetate available, which was going off for cold war purposes. Mr Domingo is clearly acknowledged by Kolff and others, in the 1940s, for developing the flame photometer.⁶⁶ Domingo came to Hammersmith and showed it to them. I am clear in my mind that Kolff had a flame photometer and Mr Domingo of Kampen was the innovator.⁶⁷

Turney: When Frank Parsons retired I took over from him, but he never quite left the unit, and over interminable cups of coffee and his pipe, he told me that he thought the key to the Leeds team getting in early was their prototype

⁶⁶ Domingo and Klyne (1949); Drukker (1989).

⁶⁷ See Appendix 2, pages 84–5. Professor Stewart Cameron wrote: 'In fact, the principle of the flame photometer goes back to about 1928. The first *practical* flame photometers were developed independently around the mid-1940s by Domingo and by Phyllis Weald and John Peters at Yale.' Note on draft transcript, 18 July 2008. See Cameron (2002): 119, notes 21–2; Epstein (2001).

Eel photometer, because his previous work, of course, had been on colonic implantation of the ureters. So Frank actually came up through electrolyte physiological pathways, even though he had originally been destined to be a urological surgeon.

Dr John Goldsmith: Liverpool was one of the only places that had a district general hospital renal unit and it came about because a urologist called James Cosbie Ross was interested in renal tuberculosis and had come across a lot of such patients in uraemia.⁶⁸ In 1956 he visited Frank Parsons in Leeds and took his ideas up enthusiastically, much against the prejudices of his various colleagues who thought that their own departments would be deprived of funds. He had a senior registrar, Eric Edwards, who was in the US at the Mayo Clinic at the time. Ross got him to bring back a Skeggs–Leonards kidney.⁶⁹ In 1958, possibly 1959, but I think it was 1958, Professor Harold Sheehan, of the Sheehan’s syndrome, referred a patient to him with acute renal failure following a septic abortion and this was one of Ross’s first survivors.⁷⁰ It might be of interest to people to know that Professor Sheehan used to obtain his post mortem material, namely the kidneys of women who had died of toxæmia, without opening the abdomen: he obtained his kidneys per vaginam without previously getting permission.

Turney: That’s a hell of a colposcopy. The story that is coming out is of individuals, surgeons and others, interconnecting informally and formally, and doing things, which would, of course, be impossible nowadays. As Stewart Cameron has pointed out, dialysis could not be invented nowadays – or at least clinical dialysis could not be invented – because of the regulatory regimes now in place.

Shaldon: For the accuracy of the flame photometer to be of any value in preventing dialysis disequilibrium, Merrill had to find a flame photometer that could easily be calibrated correctly. The inaccurate measurement of sodium through a flame was of no greater value than the chemical explanations of sodium. The only advantage of it was that it was quicker, but the standard error was something like ± 5 per cent and the precision of the US version which could give you ± 1 per cent enabled the dialysis sodium to be accurately balanced against the assumed or measured plasma/water sodium.

⁶⁸ See, for example, Ross (1953).

⁶⁹ Skeggs and Leonards (1948).

⁷⁰ Sheehan and Davis (1958).

Marsh: Not all biochemical measurements and dialysate prescriptions in the early days were quite as precise as we have heard. I vividly remember my first major contribution to nephrology was to find out from the technician for acute haemodialysis at the London Hospital what actually went into the bath of the Kolff twin-coil. It was, ‘a teaspoon full of this and a dessertspoon full of that’, and we finally came to the last thing and I said: ‘Well, what about that magnesium salt? We have got to make sure that all these things are packaged up and prepackaged so we know exactly what is going in. How much of that magnesium salt is there?’ The technician looked at me and said: ‘Oh, Dr Marsh, just a pinch.’

Dr Chisholm Ogg: Following on from David Kerr: I worked for Jo Joeekes from 1964 when he was at the Institute of Urology, University of London, and it was my job to administer dialysis if anybody needed it. I spent a lot of time watching blood going round a twin-coil, but whenever I moaned about this, Jo would tell me that I didn’t know how lucky I was. He would recite innumerable stories about winding tubes of cellophane around drums, a process that seemed to take about 12 hours’ preparation before you got near the patient. He also made the point about leaks at the couplings at either end of the tubes, which he said were the bane of his life. The third point he made was that all the patients who were connected to this apparatus had major rigors, and that this was, again, something this modern, pre-packed, wonderful twin-coil kidney circumvented. I was actually jolly lucky to be allowed to sit there in peace and quiet.

Turney: I think we have got to the early 1960s and maybe we can move into the era of dialysis for chronic renal failure.

Hopewell: Before we leave this period, I would like to suggest that dialysis had a role in the preparation of patients for transplantation. I know that those at St Mary’s Hospital, London, are generally regarded as being pioneers of transplantation in this country, which started in 1955 with Charles Rob and James (Jim) Dempster’s operation.⁷¹ Jim Dempster tells me that this was actually for acute renal failure and was a disaster. They relied on peritoneal dialysis in a proportion of their cases up until the mid-1960s. Whether a Witness Seminar on dialysis includes peritoneal dialysis, I don’t know, but I should very much like to ask the Leeds contingent – Dr Hoenich and others – whether Peter Raper’s historic transplant in 1959 had preparatory haemodialysis, or his other two in 1962 or 1963? Neil Turner has kindly told me that Michael Woodruff’s

⁷¹ Dempster (1953; 1956).

identical twin kidney transplant on the 31 October 1960 was dialyzed; but with what type of artificial kidney? He hasn't told me yet.⁷² I wonder if anybody has any word about this early use of dialysis in that way.

Turney: The first Leeds transplant, which was not a great success for various reasons, was performed on a lady with acute cortical necrosis following an antepartum haemorrhage that occurred on the seafront at Filey, which is not the centre of the medical universe.

Shall we move on? We have had to guillotine this discussion, because peritoneal dialysis is a story in itself, it goes back and forwards, and then reappears and is reincarnated.⁷³ We are really thinking haemodialysis up to about 1980 and how it all started in the UK. I know that is restrictive but otherwise, of course, this seminar could well finish in 2009. Shall we move on to talk about the transition into the chronic era, setting up chronic units and the transition from what was in many cases a surgically driven specialty as such, so that we can create a history of the specialty as well as a history of the treatment? We haven't actually talked about where the nephrologists, as we call them now, were coming from. Was someone, somewhere, training nephrologists? Or were they people who came into it by accident, by inclination, by delegation? Would anybody like to set us rolling on this one?⁷⁴

Blagg: To take up your question about where nephrologists came from: when Scribner was a research fellow at the Mayo Clinic, he heard John Merrill talk about the artificial kidney. Scribner had been interested in electrolytes since he was a medical student in San Francisco where one of his mentors was Thomas Addis and he thought that the artificial kidney could be a useful research tool. He had a serious congenital eye condition (he received one of the very early corneal transplants in the US) and so decided that he couldn't go into private practice and would go into academic medicine. He happened to go to Seattle in the state of Washington on vacation with his family in 1951, before taking up a post in a New York hospital, and while there he looked up Bob Evans, who had

⁷² See Woodruff *et al.* (1961). Professor Neil Turner wrote: 'The patient is recorded as having a single dialysis treatment in Edinburgh on 8 October 1960, according to Dr Anne Lambie's handwritten logbook. That was three weeks before his transplant.' E-mail to Ms Stefania Crowther, 1 July 2009. Professor Stewart Cameron wrote: 'Edinburgh were then using a twin-coil kidney (since 1959).' Note on draft transcript, 18 July 2008.

⁷³ For a history of peritoneal dialysis, see Cameron (2002).

⁷⁴ See Appendix 1, page 79.

been one of his teachers at Stanford Medical School. Bob was now physician-in-chief at the Seattle Veterans' Administration (VA) Hospital and he invited Scribner to come to the University of Washington Medical School. Robert Williams, the chief of medicine, made arrangements with the New York hospital and appointed Scribner an assistant in medicine at the Seattle VA Hospital, in 1951, where he soon convinced the hospital to buy a Baxter–Travenol twin-coil kidney machine. He used to transport this in a truck to various Seattle hospitals to treat patients with acute renal failure.⁷⁵ This continued until the point where we get to the start of chronic dialysis in March 1960.

The situation then was the same as with the early days of dialysis for acute renal failure, in the sense that all of the early developments were done speedily, in a way that would not be possible today as there were no institutional reviews or ethics committees. The first patients had only a few weeks to live when they started on dialysis and they were treated without delay. New discoveries were made all the time and there was soon a small network of US dialysis physicians who were members of the ASAIO and they used to meet annually.⁷⁶ In those days one would call friends to tell them what you had done today and tell them whether it worked or not to do it because this or that went wrong.⁷⁷

As with acute renal failure, the renal 'establishment', particularly renal physiologists, were very much against the idea of dialysis for chronic renal failure and said it would never work. After three of Scrib's four patients had survived for some eight or nine months, he applied to the National Institutes of Health (NIH) for a grant to continue his work. The site committee visited Seattle in February 1961 and Scribner was told that they would not give him another grant to expand the programme because he wasn't doing a controlled study. The antagonism to chronic dialysis continued for a number of years and, for example, when I chose to go to Seattle on an NIH research fellowship in 1963, I was strongly advised by some not to do so.

The turndown by the NIH was what led eventually to the establishment of the Seattle Artificial Kidney Center (SAKC) as the university hospital would

⁷⁵ Blagg (2006).

⁷⁶ ASAIO first met in Atlantic City, New Jersey, in June 1955. It continues to hold an annual conference and publish a journal six times a year. See www.asaio.com (visited 25 March 2009).

⁷⁷ Professor Stewart Cameron wrote: 'I founded and co-ordinated a very informal dialysis group in the UK during the 1960s – I think, 1965/6 – to broaden these conversations, tips, and to provide contacts and advice in those early days. See Cameron (2000a): 22.' Note on draft transcript, 18 July 2008.

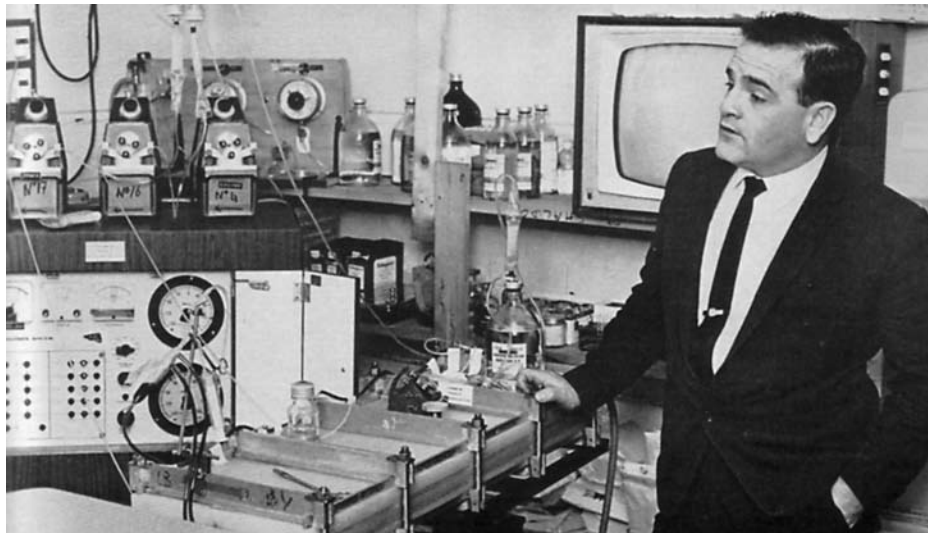

Figure 8: Dr Stanley Shaldon at the Royal Free Hospital in 1966.

not allow any more patients to be treated because they were frightened that when the existing grant support ran out these expensive patients would become a charge to the state of Washington. So Scribner and James (Jim) Haviland established the SAKC as a separate, not-for-profit community-supported free-standing dialysis unit that opened its doors on 1 January 1962 as the world's first out-of-hospital dialysis unit.⁷⁸ One thing they had found during the first year of chronic dialysis in the hospital was that there was no need for a doctor to be present all the time during dialysis as the technology was simpler than the old rotating drum and the patients were generally more stable than patients with acute renal failure. So dialysis became a nursing procedure, even though nurses were not allowed to start intravenous infusions in the state of Washington at that time.

Dr Stanley Rosen: You asked the question: 'Where did the nephrologists come from?' Originally I was interested in joining Sheila Sherlock as a liver registrar, but she said, 'Stanley Shaldon is developing something, why don't you work with him?' So I went to the unit at the Royal Free Hospital where we did about six or seven years' worth of work in about two years. It was a very exciting time, because Stanley was determined that we were going to develop a chronic dialysis system. Maybe I shouldn't talk too much and let Stanley do it. After working

⁷⁸ The SAKC was renamed Northwest Kidney Centers (NKC) in 1970. For a history of the NKC, see www.nwkidney.org/nkc/aboutUs/ourHistory.html (visited 16 November 2008).

with Stanley I went to join Merrill in Boston in 1964, and then came back to set up one of the first NHS-organized dialysis units in Leeds in 1966.⁷⁹ I have a lot of stories to tell about all the various parts of my career, but I will defer to Stanley, except to say that the unit at the Royal Free, which he founded, was a hive of activity (Figure 8).⁸⁰

Shaldon: I think Jean Hamburger invented the term nephrology.⁸¹ There were people who were cardiologists with an interest in kidney disease, but there was no specialty in nephrology in my day, except at the Hammersmith Hospital, where I think it was called renal medicine; I don't think it was exactly called nephrology. Hamburger and Gabriel Richet would insist that they introduced the term nephrology to the world,⁸² at the meeting they held in Evian, France – some of us were there – the first International Congress of Nephrology in September 1960.⁸³ I was sent as a registrar who had left the eminence of the Royal Postgraduate Medical School to go with Sheila Sherlock, in November 1959, to be supportive to her as the first full professor of medicine at the Royal Free Hospital, a female first. She was creating new posts and offered a lectureship

⁷⁹ Dr Stanley Rosen wrote: 'Until 1966 dialysis for ESRD was provided by a few academic units to a negligible number of patients selected by happenstance. In 1966 prototype services were set up by a national governmental authority in an attempt to provide treatment for every patient that would benefit throughout the UK.' E-mail to Mrs Lois Reynolds, 27 September 2009.

⁸⁰ Mr John Hopewell wrote: 'This is a widely held belief, but is inaccurate. I, a urological surgeon, founded the renal unit at the Royal Free in 1957. In 1960 Stanley Shaldon joined the unit and developed maintenance dialysis from spring 1961, using twin Seldinger catheters in the femoral vein.' Note on draft transcript, 18 July 2008. See Rae *et al.* (1963). Further comment by John Hopewell and the manuscript of his lecture, 'Early history of the Royal Free Hospital renal unit', delivered to the Old Student's Association at the Royal Free Hospital in 2006, will be deposited, along with the records of this meeting, in archives and manuscripts, Wellcome Library, London, at GC/253.

⁸¹ Professor Stewart Cameron wrote: 'There has been much argument and discussion over the origins of the terms "nephrology" and "nephrologist". The earliest use – as opposed to a presence in a dictionary, which goes back to the mid-nineteenth century, both in France and the US – was by Arnold Osman of Guy's and Pembury Hospitals in 1945.' Note on draft transcript, 18 July 2008. See Cameron (1997): 1528.

⁸² Robinson and Richet wrote: "Coinage" of the term "nephrologie" for use in the title of this first "International Congress of Nephrology" has been attributed to Hamburger... Whatever the truth, it is at least certain that Jean Hamburger identified and gave new life to an older word, one that now stands as the definitive descriptor of a new medical specialty.' Robinson and Richet (2001): 6.

⁸³ The First International Congress of Nephrology, 1–3 September 1960, was organized by four national societies devoted to the study of the kidney: La Société de Nephrologie, the Scandinavian Society for Kidney Research, La Società Italiana di Nefrologia and the Renal Association of the UK, with the assistance of the American Society for Clinical Investigation and the Société des Eaux d'Evian. See Richet and Muller (2001).

in nephrology to a young lady whom I knew at the Hammersmith and whom Chris Booth knew even better.⁸⁴ I think it was one of the first appointments in the UK using the term nephrology and Sheila created this division, but the lady in question refused the post. So I was told: ‘You will become a nephrologist, you will go to Evian, and you will learn all about nephrology.’ There were 200 people there, mostly salt-and-water people who called themselves renal physiologists and Hamburger, who called himself a transplant nephrologist.

Dr William Cattell: May I go back to your original question as to where the nephrologists, as we now call the doctors interested in dialysis, came from? My impression, and I am perfectly happy to be shot down, is that in the late 1950s to early 1960s nearly all the people were within professorial units or academic units. Here in London there were Stewart Cameron at Guy’s, Frank Marsh at the London, ourselves at Bart’s, Stanley Shaldon at the Royal Free and also David Kerr up in Newcastle. I make the point that in the early days of nephrology, it was heavily influenced, possibly for financial reasons, by academics.

Goldsmith: I must have been the only non-academic nephrologist. Ever since my student days I have cut out articles from the *BMJ* and the *Lancet*, and put them in different files. I found out after a while that my renal file was twice as big as the others. Then, round about 1958, I helped to look after a familial outbreak of acute glomerulonephritis in four siblings, and I published this in the *Lancet*.⁸⁵ Victor Pollak, who was working with Robert Kark at Presbyterian–St Luke’s Hospital, Chicago, asked for a reprint. I thought, well, a BTA (Been to America) would be useful, so I wrote to him and asked if there was a job and there was! Six months before I was due to go there in 1959, I got a telegram asking whether I would be able to come three months early and work with Kolff, the inventor of an artificial kidney, at the Cleveland Clinic, Cincinnati, Ohio, and, of course, this was a wonderful opportunity. So I managed to work with Kolff and with Kark, and that’s how I became a nephrologist.

Marsh: At the London Hospital, nephrology was certainly driven through by the academics. It was largely driven by Clifford Wilson, who was appointed professor of medicine at the London Hospital Medical College in 1946. It was he who assured the governors of the London Hospital when they allowed treatment of the first few chronic patients in 1965 that it would only be for a very few patients, it would never take off, and it would cost virtually nothing at

⁸⁴ Dr Lavinia Loughridge FRCP was at that time married to Dr Christopher (later Sir Christopher) Booth.

⁸⁵ Goldsmith *et al.* (1958).

THE LUCKY THIRTEEN

These People Cheat Death In The Lifeline Club



Here is London's Life-line Club—the 13 patients at the Royal Free Hospital who would be dead but for their artificial kidneys. The second person from the right in the bottom row is Mr. Robin Eady, 24-year-old medical student at Guy's Hospital, who has lived for two years—the longest survivor in Britain. With the 13 is Dr. Stanley Shaldon, a kidney expert.

Back row, left to right, are: Daniel McGill (aged 25), factory supervisor from Kilburn; James Watkins (36), publican, Camberwell; Roy Bostock (38), interior decorator, Woodford; William McNaughton (29), accountant, Hackney; Richard Bezzant (24), market research executive, Highgate; Barry Chant (32), chartered accountant, Muswell Hill and Malcolm Sweet (19), student teacher, Finchley. Bottom row: Raymond Jones (34), electrical engineer, Slough; Paul Jones (42), playwright, Kensington; Mrs. Olga Heppell, of Harlow, Essex; Dr. Shaldon; Mrs. Huguette Ramalingum (26), housewife, Stepney; Robin Eady; and Kenneth Hall (37), company director, Greenwich.

Figure 9: Dialysis Patients of the Royal Free Hospital pictured in the *Evening News*, c. 1965.

all. He knew exactly what he was doing. It was Clifford Wilson who drove it, and the people who ran chronic and, slightly earlier, acute haemodialysis at the London were all lecturers on the medical unit. They put in their own Scribner shunts. The first one I ever did was in about 1966. I had seen only one done, when a professor of, I think, mathematics at Queen Mary College came in with severe acute renal failure and Clifford told me that I was designated to put in the Scribner shunt. I said: ‘But Professor Wilson, I have only seen one done before’ and he said: ‘Marsh, I have the greatest confidence in you.’

Turney: Did it work?

Marsh: Yes. Otherwise I wouldn’t be here.

Turney: The other thing that was happening in the early 1960s – when dialysis medicine started to be practised in units that were actually separate from, although within, hospitals, and with their own staff – was the appearance of the specialist nurse. I wonder whether we can perhaps expand on that a little to bring in the other people?

Cattell: As people have said of their experiences, and I remember mine of the twin-coil vividly, there was usually a doctor present. The advent of chronic dialysis introduced the nurse specialist. I don’t believe we could have got off the ground with significant dialysis programmes without the help of the nurses. We have some of them here, who I am sure will contribute to this seminar.

Miss Lesley Pavitt: I am slightly hesitant to start this because the lady who taught me everything I know, Mrs Ann Eady, is sitting in the front row. I was quite lucky to get to the Royal Free very early in 1967, at which stage dialysis was already a nurse-led programme, and I remember my very first day there, when the nurses had just made a decision not to tie the lines on to the Kiil any more. The consultant did a ward round and asked: ‘Why aren’t you tying them on? This is dangerous.’ The nurses said: ‘Well, they are fine if they don’t fall off’, and then as he went out, they beeped him when he got down the ward saying that the venous lines had all fallen off, and I thought: ‘I have come to the maddest place on earth!’ It was very different, and coming from a traditional training hospital into that environment where previously everything you did was under the say so of the doctor, it initially seemed to me to be a very bizarre way of working. I think Bill Catell is right. I don’t think there were any other specialist nurses around in those days; we were probably some of the first.

Mrs Ann Eady: I started in the renal unit at the Royal Free in about 1964. It was a slightly unconventional beginning, because I had had glandular fever so I had taken my state finals, but not my hospital exams, or vice versa. I was hanging around for three months and the matron asked me: ‘What would you like to do? We don’t know what to do with you.’ I said: ‘I would like to go and work with my colleague on the renal unit,’ so she said: ‘Hmm, yes’, and off I went. It was delightfully unconventional and suddenly we were not just nurses, we were also learning to be technicians. There were certainly no protocols, you were taught absolutely nothing in terms of ‘doing courses’. Health and Safety would have had a complete fit all round. It also taught me, I think, the resilience of humans.

What I particularly enjoyed was teaching home dialysis to families, because this was the beginning of managing to put patients in their homes so that they could care for themselves. One other little thing about becoming a nurse specialist: when I worked at Guy’s Hospital with Stewart Cameron and Chisholm Ogg there were lines of patients waiting to have their needles inserted into their fistulas. Both Chisholm and Stewart were busy doing something or other and we nurses were standing around waiting. When finally they did appear they said: ‘This is ridiculous, would you like to learn how to do this?’ And we said: ‘Yes, please!’ They said: ‘Right, OK, this is how you do it.’ And so we just learnt very, very quickly, and it was great.

Turney: And it was informal?

Mrs Ann Eady: Very. Very informal: ‘This is how you do it, OK.’

Baillo: We started a teaching programme in 1966 at the Royal Free. It was a formal programme, with lectures and a promotional booklet. We were able to get the matron’s support and permission to teach her nurses. At the time we were teaching patients and relatives to dialyze, so it was natural to include the nurses.⁸⁶ There was a training programme then, but I don’t think they exist any more. It horrifies me, because we established training programmes in 1966 and kept them going because it was a way of recruiting staff for the department.

Pavitt: Yes, I think they still do, but they are now run at universities and they are reasonably academic. Whether you would trust someone with that certificate to actually dialyze you is another matter.

Turney: The other issue is that they recruit people as students who are already doing it. So I think the point about practical training has gone. And if you

⁸⁶ See Baillo *et al.* (1967).

can say that doctors delegated to nurses, nurses now delegate to non-registered general nursing staff, so it really has moved away from the original pattern. And, of course, nowadays the machines look after themselves.

Dr Roger Greenwood: I was a latecomer to all this, but I am interested to know when non-registered nurses first appeared in the specialty, because they have become a very significant part of the workforce now. I understand they were first introduced in Kent and Canterbury Hospital, but I may be completely wrong. I would be interested to know, also, if any other specialties had contemplated non-registered nurses being so involved in patient care, or was it first seen in renal units?

Turney: I think this is a very important point, because in Leeds they called them technicians, but these were unqualified people by any medical standards, who were recruited from the general community, from shops and wherever, to provide the dialysis service.

Baillod: I have been waiting for Stanley Shaldon to mention the Royal Free, but he hasn't done so yet. The original machine was acquired and used by Mr Hopewell and then, as Stanley said, he was sent to the Hampstead branch of the Royal Free to develop and use it. At one point we managed to fall out with the matron and we did not have nurses, so we employed our own nurses as technicians. Stanley, you must remember this?

Shaldon: I certainly did not accept a lectureship in nephrology to be a dialysis doctor. I don't wish to disparage the profession, but I thought I was in academic medicine, and was more interested in measuring renal blood flow by using cardiac catheters than dialysing patients.⁸⁷ John Hopewell had the artificial kidney and indeed he was gracious enough to allow us to start treating patients with acute renal failure in 1961. Interestingly, because of our cardiac catheter and organ blood flow techniques, we were very familiar with using the Seldinger technique,⁸⁸ so we managed to make ourselves independent of the surgeons who were never around when we needed to dialyze, and we could insert catheters ourselves instead. This was not due to the surgeons' unwillingness, but usually they were operating when we needed them to cut down and put a piece of tubing into the artery and a piece of tubing into the vein, which was the standard approach to the emergency dialysis system in those days, not a Scribner

⁸⁷ See, for example, Shaldon *et al.* (1962).

⁸⁸ See Seldinger (1953).

shunt. So it was really by chance, if you will, that I got involved with dialysis. The way you end up in life is never the way you planned it. Certainly, as an academic lecturer in nephrology and going to the first International Congress of Nephrology, I didn't see myself in those days as the person I seem to have ended up as, but I guess that's life.

Blagg: Three quick points: I had no intention of being a dialysis doctor, but within days of my arriving back in Leeds in January 1958 as a research fellow interested in thyroid disease, Brian McCracken's son was killed in an accident and Brian left to go back to the US, as his wife was American. I was bottom of the totem pole and was told: 'The artificial kidney is yours.' I was now the department of medicine's representative and was told to go to work with Frank Parsons. In terms of technicians, as John mentioned, we didn't have a technician at that time and for two years Frank and I did it all ourselves with some help from urology registrars, including sterilization and then winding the cellophane tubing on to the drum and all those sorts of things. The technician we eventually acquired was a hospital porter, Brian Auty, and he turned out to be superb and stayed with the unit until he retired. So you didn't need to be very skilled in those days when we were all learning how to do dialysis.

Turney: Yes, I remember that technician. Frank Parsons bequeathed him to me. He looked after me very well.

Booth: May I ask two general questions? One relates really to academia, and the other to money. As far as academic medicine is concerned in London, one has to recall that until the end of the war there were only five professors of medicine in the 12 undergraduate schools in London. The Royal Free got its first professor in Sheila Sherlock (later Dame Sheila) in 1959, Westminster in 1960 got Malcolm Milne, and the last undergraduate professor of medicine to be appointed in London didn't get appointed until 1964, and that was John Anderson at King's.⁸⁹ So academic medicine as we now know it was very much a young and tender flower then. The other professors who had been there right up until, say, 1960 had a battle establishing themselves among the part-time consultants who arrived in their Rolls Royces. As Francis Fraser always said when he was at Bart's, it is very difficult to recruit people to academic medicine when they could see Lord Horder arriving in his Rolls Royce. There

⁸⁹ Dr Frank Marsh wrote: 'The first professor of medicine at the London Hospital was Arthur Ellis, (previously Regius professor of medicine at the University of Oxford) when he was also consultant physician and director of the medical unit at the London Hospital.' E-mail to Ms Stefania Crowther, 7 August 2009.

was a financial disincentive in academic medicine; you earned much less. You didn't do private practice, not in those days, so you were poorer as far as your lifestyle was concerned. There were problems. That was the first problem in recruitment.

The second problem was the MRC. I know about the unit in Leeds, but could somebody say whether the national body for medical research in this country became involved in dialysis at all, because their attitude to Denis Melrose when he was developing the pump for cardiac surgery was: 'Oh no, that's mere technology.' I don't know what the MRC did about dialysis. I do know what they did about Roger Williams trying to develop an artificial liver at King's, which was unsuccessful.⁹⁰

Turney: I think David Hamilton will support me from his researches: as far as I can make out, Leslie Pyrah slipped Frank Parsons and dialysis into this and the MRC never officially approved or disapproved. They just accepted it as a *fait accompli* and, provided that publications were coming through, they were willing to do so. I don't think they thought that dialysis was anything more than a little experiment that wouldn't last. And, because transiently Leeds and the Hammersmith looked after the whole of the UK, Leeds got patients coming from Glasgow, Belfast and all over and they were swamped. The MRC said: 'Well, that's unfortunate, but your job is actually to be the assistant director of the unit.' So that's the only time they actually ever expressed an opinion; they mainly kept themselves aloof. I think that's right, isn't it?

Hamilton: Just to confirm that: I dredged my way through the MRC records in the National Archives, at Kew, for this very matter and it's clear that Pyrah's skill was spending MRC money for biochemistry on dialysis. Biochemistry was the MRC's priority at that time; understanding the internal chemistry of the cell was going to produce the goods in the long term, and they were looking long term. So, to give them their due, that was their priority, and Pyrah's skill was to use this big grant for a chemical unit and skilfully divert energies and resources into the kidney work, as it happened.⁹¹

Turney: One little thing on this particular point: we have to remember that Leeds General Infirmary was possibly the second richest hospital in the country

⁹⁰ See Melrose (1953); Williams (1978).

⁹¹ The MRC metabolic disturbances in surgery unit, Leeds General Infirmary, was established in 1956 with Professor Leslie Pyrah as honorary director, until 1964, when Professor B E C Nordin was appointed director. See Hamilton (1984).

and the special trustees or the board had about £1 million to dispose of as they wished, which in 1956 was a huge amount of money. So, buying this machine for c. £2500 was small change. The huge support came internally within the hospital, nursing staff, junior doctors being seconded by the professor of medicine and things like this, so I think that's how it got going in Leeds.

Cattell: We are now on something we touched on earlier, which was the resistance of the medical establishment to the development of dialysis. My old boss Max Rosenheim, who had considerable influence with the MRC, was utterly opposed to dialysis.⁹² One of his successors, whom you all know, Oliver Wrong, once assured me that I had given up being a doctor and was now a plumber.

Professor Robin Eady: Perhaps my perspective is somewhat different because, as some of you know, I am a renal patient as well as a doctor (Figures 9 and 10). I was a clinical student at Guy's Hospital in 1962 when I became very ill with very high blood pressure and rapidly declining kidney function. Sadly, Stewart Cameron wasn't around at Guy's at the time and they didn't feel that they could do much for me. I found myself in the Hammersmith and was under Ralph Shackman and Sir John McMichael, and in fact, that culture about dialysis that Bill Cattell has just mentioned was very prevalent. I had to be treated conservatively and there was some suspicion about dialysis and this rather strange chap Scribner, who had been a fellow at the Hammersmith Hospital earlier, as we have heard, and had fiddled around with electrolytes and developed this programme. I have to say that, apart from one person – in fact it was Colin Dollery – there was very little encouragement for me to go to start dialysis in the US, which I did as a patient of Scribner's exactly 45 years ago.⁹³

If I could just say that I was also a very early renal technician and even in 1963 we were still weighing up the chemicals in order to make the fluid and we didn't have a flame photometer available. However, one of Scribner's other inventions was a bedside kit that allowed one to get a rapid and, I think, reasonably accurate estimation of chloride, using a small resin column. We used

⁹² Lord Rosenheim (Baron of Camden) chaired the Ministry of Health committee on intermittent dialysis, 1964–66, which reported in favour of dialysis. Dr William Cattell wrote: 'Lord Rosenheim was a very discreet operator and never published controversial material. My comment relates to a personal conversation with Lord Rosenheim when I came back from the US in 1964 and battles were going on between Stanley Shaldon (aided and abetted by Hugh de Wardener) and the department. I sought his advice about the future of renal medicine at Bart's.' Letter to Ms Stefania Crowther, 7 July 2009.

⁹³ See Eady (2001, 2008).



Figure 10: Robin Eady receiving haemodialysis in the 'side room' of the Royal Free Hospital renal unit in 1966.

that fairly successfully.⁹⁴ I don't remember any tragedies as a result of bad fluid compositions, but it was a refrigerated system and perhaps we will come on to the development in the early 1960s later on. That was my recollection and you are absolutely right, there wasn't great encouragement from many of the prominent academic physicians to enter a dialysis programme as a patient.

Turney: I think that's fascinating and we will be coming back to you later. We have mentioned the Kolff twin-coil that became Travenol. Can we start bringing in the role of industry and the technical developments? What happened to British industry? I remember when I started, Lucas and Cambridge machines were the only ones that seemed to have a government kite mark or whatever they had at that time.

Mr Eric Collins: I seem to be the only 'beastly commercial' here. I think the fact that so many British medical companies have disappeared is a tragedy.⁹⁵ The reasons must be many and varied, but it must have something to do with the culture of the time. British companies appeared to be reluctant to engage outside the UK. The companies you mention, such as Lucas, Cambridge and many others, including Watson-Marlow, all had the ability to produce and

⁹⁴ See Scribner (1950).

⁹⁵ See Tansey and Christie (eds) (2000): 27, 32, 34–6.

develop dialysis equipment to the demands of the doctors and to the special requirements of Dr Shaldon and others who were sending patients home to treat themselves. In the late 1960s and early 1970s, dialysis equipment was purchased on central contract and delivered to hospitals as and when required.⁹⁶ The demand for machines in the UK was disproportionately high because of the demand for home treatment, even though the total dialysis population was much lower here than, say, Germany, France and Italy. The companies therefore did not have to work particularly hard to make a decent business. Perhaps they got fat and lazy. If that seems unfair, I would like to make the point that central purchasing did not, in the end, do British industry many favours.

Shaldon: I would like to put an alternative view, as somebody who was involved. In fact, Dylade was the company, if you check the company's register, which was founded by my father for me in 1965 and the idea was that it would provide dialysis for home dialysis patients. Indeed, it was bought by an American company called Milton Roy, which was the first to produce, with the help of the Scribner engineering team, a properly designed automated system for dialysis, which preceded the Lucas machine and others like it.⁹⁷ It worked very well, but it was rather over-sophisticated in its rather poor soldering of the circuit boards that controlled the alarm systems and the logic. The first models were built, in fact, for Scribner in 1964 and they abandoned this machine, curiously enough, and went for a much simpler machine made by Drake Willock.⁹⁸ We persevered with the Milton Roy machine, which then became the Dylade machine and which was supplying most of the European markets in competition with Drake Willock. So, there was a distinct element of British scientific engineering that went into producing a workable dialysis machine, which in fact went all round the world. We put machines, later on, as far afield as Colombo, Sri Lanka, so I don't totally take Eric Collins's view of this, because Gambro were a latecomer

⁹⁶ See McBride (1979). Mr Eric Collins wrote: 'The contracts for dialysis machines emanated from the DHSS technical branch, Russell Square, London. Cambridge Instruments, Lucas Medical and Watson-Marlow eventually all disappeared from the market. These were all (as far as dialysis was concerned) only small divisions of much larger companies. Dylade were successful internationally and were only taken over by the German company Fresenius in 1985.' Letter to Ms Stefania Crowther, 6 July 2009.

⁹⁷ Professor Christopher Blagg wrote: 'The Milton Roy dialysis machine was based on a machine developed by Les Babb, professor of nuclear engineering at the University of Washington for use by Seattle's first home haemodialysis patient in 1964. (See Babb (1995))'. Note on draft transcript, 8 July 2009.

⁹⁸ The Drake Willock machine was created by Richard Drake and Charles Willock in Portland, Oregon, in 1964. For an interview with Richard Drake see: www.voiceexpeditions.com/index.php?id=230 (visited 1 April 2009).

to this field.⁹⁹ Their machine was a sort of stainless steel monster from Lund, which nobody in their right mind would have used to start with, and it took them some time.¹⁰⁰ Don't you agree?

Baillod: It was huge, but then the next ones came along.

Shaldon: Yes, the next one came along, because they took the Milton Roy pumping system from the US, which was the heart of the machine.

Collins: Yes, it was a monster, and in consequence of that, of course, it was never used in the UK; it was never presented to the UK, and we didn't really start until the late 1970s.

Dr Nicholas Hoenich: Perhaps I could just come back and say a little bit about what Eric Collins said before. I think one of the things that we do forget is that many of the items of equipment that we take for granted were all purchased under central contract after 1969, which was at that time handled by the Department of Health and Social Security (DHSS). I think Eric is right that there was reliance within companies on these DHSS contracts. I recall that one of the first tasks I was given when I went to Newcastle in 1968 was to evaluate the Heppell and the Watson-Marlow Kiil-type dialyzers with a view to deciding which one the DHSS was going to issue on central contract.¹⁰¹

⁹⁹ Gambro began mass production of dialysis machines in Lund, Sweden, in 1967. See Gambro (2006). See also www.gambro.com/int/About-Gambro/The-Gambro-Story/ (visited 1 April 2009)

¹⁰⁰ Gambro (2006): 16–17.

¹⁰¹ Hoenich *et al.* (1970). Dr Nicholas Hoenich wrote: 'A working party on intermittent dialysis for chronic renal failure was set up in 1965 under the chairmanship of Hugh de Wardener to advise the Minister of Health on clinical policy and on the development of equipment. Clinicians were dissatisfied with equipment that would not perform correctly and the working party requested that the Ministry of Health (MoH) carry out independent trials of all equipment. The scientific and technical branch of the MoH's supply division contracted the Atomic Weapons Research Establishment (AWRE) to undertake prototype or early production models of single patient haemodialysis machine evaluations at Aldermaston, Hampshire. The AWRE was selected because it had a team of government scientists with a working knowledge of the techniques and engineering methods in use in haemodialysis machines (see Robinson (1974)). This led to a similar contract programme being established at Newcastle upon Tyne for haemodialyzers. A more formal funding arrangement on a three-year rolling budget followed and the programme was integrated into the evaluation programme funded by the DHSS scientific and technical branch. This programme was subsequently embodied into the DHSS/NHS procurement directorate and ran until 1996. Data collected in the course of the programme was disseminated in the form of individual reports to each of the renal units in the UK and also formed the basis of a public domain review article in *Artificial Organs* (Woffindin and Hoenich (1995)).' E-mail to Ms Stefania Crowther, 30 June 2009.

Turney: So, there was quite a lot of control at that point, into the 1970s.

Dr Felix Konotey-Ahulu: I am wondering whether I could underline three historical aspects, which I think are important. The first is the spirit of dedication in the renal units, the second is the accuracy of the laboratories and the third is clinical acumen. I got into dialysis as a result of ending up at the Hammersmith Hospital as a postgraduate student. After his lecture, Dr Gerry James came over to me and asked me what I was doing in England, and I said that, having trained at the Westminster Hospital, I had gone home to find that I saw more high blood pressure and kidney failure in Ghana in six months than I had seen in three years in Westminster. I had come to England to see if I could do work on kidneys. So he said: ‘Oh, I will introduce you to my wife; she is called Sheila Sherlock and she has a kidney unit.’ So, within a week I met with Dr Sherlock. She didn’t even interview me at all; she said: ‘I am going to assign you to a gentleman called Stanley Shaldon, who will look after you.’ So I met Stanley in the early 1960s.

The first thing to mention about that unit at the Royal Free is the dedication: the dedication of the leadership in dialysis was extremely important in those early days. I would be in the dialysis room and Stanley Shaldon would turn up unexpectedly and look at the drip and if he found a bubble in the wrong place, he would say: ‘Come on, move, Felix, we are not in the jungle, come on, move, hurry up.’ With this kind of frank exhortation we all bucked up. I remember Robin Eady on dialysis in those days. At the end of the day Stanley Shaldon would come round and say: ‘Let’s all go for dinner.’ But the degree of dedication of the team in those days was always very important.

The second thing is about the laboratory: I went home to Ghana after getting the Membership of the Royal College of Physicians and they had heard that I had worked at the kidney unit at the Royal Free, so they gave me a kidney machine and asked me to get on with it. I said I wanted a week to decide about this. They said: ‘Why? You have got a kidney machine: get on with it’. I said: ‘Look, give me a week, come back in a week and I will tell you.’ So as soon as they left I went into the ward and I took the blood of a patient called Attilo Ablo. I divided it into three. I put a third of the sample in a tube which had Attilo Ablo written on it. I put the second in a tube with another name on it, and the third sample in a tube with yet another name. And the laboratory came back with different values: the first had 80 mg of urea, the second 218 mg of urea and the third one was absolutely haywire. When those who wanted me to start dialysis came back, I said to them: ‘Look, where I was, at the Royal Free, they do not trust the hospital laboratory, they had their own lab at the side of

the dialysis room.’ I think that was extremely important for anybody to have in those days in order to make a success of dialysis. I must say I turned down their request and I went into haemoglobinopathy instead, which is now my speciality. Dialysis in Ghana had to wait until Dr Yaw Anim-Addo who had worked in Newcastle and Dr Dwomoa (Jo) Adu, who worked in the department of Dr Des Oliver in Oxford, arrived back in Ghana.¹⁰² They knew the value of a reliable laboratory and that was how we established kidney dialysis at the Korle Bu teaching hospital in Accra in 1972.¹⁰³

The third point I want to make regards clinical acumen. In February 1965 I observed that my father-in-law had periods of somnolence, and he was having epistaxis. I told my wife that I thought he had kidney failure. He was English. I went to Stanley and I said to him, ‘I think my father-in-law has kidney failure and he is about 80 years old. I wonder if you could help’. Stanley saw him and found the urea content in his blood very high. Because of Stanley’s acumen he said to me: ‘Felix, he’s almost 80. We are going to put him on dialysis. If he has obstructive uropathy, he is likely to improve, but if he has glomerulonephritis producing a state of renal failure, I’m afraid we will have to dialyze him for another two weeks and stop’. And we agreed. He investigated him and found that it was a case of end-stage renal failure. I must say that during the two weeks that we had before he died, an extraordinary two weeks, he came round. He was clear in mind, singing hymns and rejoicing and it was amazing. So, these three things: dedication, a good laboratory and good clinical acumen.¹⁰⁴

Cameron: A quick point, but I think an important one, and perhaps Robin Eady might like to comment, more from the inside, as it were. We have heard how nephrology was one of the earliest specialties, perhaps along with intensive care, which, of course, was growing during the 1960s in parallel with the introduction of technologies in medicine, which liberated nurses in to a huge variety of roles and gave them greater responsibilities than they had had before; and how important that was, as it turns out, in the shape of medicine as we know it today.

¹⁰² Dr Felix Konotey-Ahulu wrote: ‘Dr Dwomoa Adu FRCP is consultant physician, department of nephrology, Queen Elizabeth Hospital, Birmingham, UK, see Adu *et al.* (eds) (2001).’ Note on draft transcript, 1 August 2008.

¹⁰³ See Anon (1974).

¹⁰⁴ Dr Felix Konotey-Ahulu wrote: ‘Some of the memorable publications on the unit (plus a recent 2008 comment) include Konotey-Ahulu *et al.* (1965); Konotey-Ahulu and Anderson (1965); Baillod *et al.* (1965); Konotey-Ahulu (2008).’ Note on draft transcript, 1 August 2008.

I don't think it's too arrogant of nephrologists to claim that they helped to change the relationship between doctors and patients. I think nephrology, in many ways, was one of the first specialties that liberated patients. There had been areas that could have done this but in some ways didn't: I am referring here to diabetes – from any time from the 1920s onwards, diabetics could have been given enormously more control over their own individual destinies and had their opinions and their views of the navigation of their disease path through life listened to. I think this first happened during the 1960s in nephrology. The idea that a doctor and a patient with a chronic condition take out a contract with each other, which is now standard in medicine and is quoted widely in all areas, was pioneered in the 1960s in nephrology, almost by default. I think there were leading speakers in favour of this attitude, including, of course, Stanley Shaldon, but I think it happened in numerous other units, almost by instinct.¹⁰⁵ We were going to ask patients to do so many things with their lives and in their lives, and we were going to invade their homes especially and so they would have to take more responsibility as well. I think that the role of increased nursing responsibility and the role of increased patient autonomy are two areas that nephrology significantly contributed to medicine in the past half-century.

Pavitt: While we were talking about other disciplines, I felt that there were other people we ought to remember and recognize. First of all, the technical staff who actually ran the machines and played with the pumps and changed things. Many people will well remember Germaine, who built the Kiil dialyzers at the Royal Free, and her friend Agatha. When I first went to the Royal Free there were non-registered nursing staff who were very involved in managing dialysis, and I think a lot of what happened wouldn't have gone on without them.

Professor Robin Eady: This will probably bring us in later to home dialysis where patients and their carers were so closely involved with day-to-day care. I think Stewart Cameron is absolutely right: dialysis did open up all sorts of avenues which hadn't been looked at in this way before, in the relationship between the patients themselves, the medical staff, the technicians, the nurses and everybody else. I hesitate to use the term unique, but I think it probably was unique in its day. It didn't only make for excellent management of the patients, but it illuminated how things could be done in other branches of medicine. I think it's very sad to see – and this can come up later, perhaps – that this sense of empowering patients, giving them autonomy and making them responsible for their own treatment to a high degree seems to be diminishing in many ways.

¹⁰⁵ See, for example, Shaldon (1968).

Professor John Galloway: It seems to me that there is a bit missing from this very interesting discussion and I would like to ask a question. Nothing ever comes from nothing. What piece of kit immediately preceded these artificial kidneys? The way that the discussion has gone today gives the impression that suddenly they appeared. What was there before? Did they arise from some earlier piece of technology, whether it had anything to do with kidney dialysis or not? Does anyone know the answer to that question?

Turney: Well, Stewart Cameron does, of course, in great detail, but essentially there was 100 years of science, going across membranes, osmosis, all these things.¹⁰⁶ There were attempts at clinical dialysis in Germany in the 1920s and 1930s, sort of one-offs, then heparin appeared.¹⁰⁷ So there were lots of things going on in the scientific milieu that needed to come together. Whether they were deliberately put together by the three mentors is unclear, because the extraordinary thing about clinical dialysis was the simultaneous invention of artificial kidneys by Nils Alwall, Willem Kolff and Gordon Murray, and they were almost certainly isolated because they did it in 1943 or 1944, when they couldn't talk to each other because they were in different continents and the Second World War was taking place. So, yes, it did appear apparently out of the blue and that's the popular myth, but in practice there was a lot of science behind it.

Cameron: I think there were others, at least two other people who built artificial kidneys during the Second World War, one of whom actually used it as well, Jonathan Rhoads of Philadelphia in 1944, in addition to the big three, which is in my book, if you have a look.¹⁰⁸ They all acknowledged that William Thalhimer was the person who gave them the idea of making practical dialysis and doing it. He was a laboratory haematologist in New York and was in contact with Charles Best's laboratory, of Banting and Best and insulin fame. They were purifying heparin for Gordon Murray, who was one of the three who started dialysis, to use in cardiovascular and cardiothoracic surgery. So we had heparin and cellophane tubing simultaneously. Thalhimer somehow or other – we don't know much about him and he certainly never said anything in his papers about how he got the idea – realized that the new sausage skin tubing made of

¹⁰⁶ See Cameron (2002): 8–31. See also the papers in Tosteson (ed.) (1989).

¹⁰⁷ See Cameron (2002): 61–8 and page 22.

¹⁰⁸ Jonathan Rhoads (1907–2002) was professor and head of the department of surgery at the University of Pennsylvania. See Rhoads in discussion after Fine *et al.* (1946); Barker (2005); Cameron (2002): 134–5 and photograph on page 56.

cellophane, which itself had been around in sheets for 30 or 40 years, could be used together with heparin to make a practical dialyzer, because the older forms of dialysis that the science had led to, which John just mentioned, were highly impractical.¹⁰⁹ If you read the accounts, it was obviously a nightmare dialyzing with hirudin extracted crudely from leeches, and collodion was a membrane that fractured easily and had to be prepared individually for each dialysis. If you can imagine using a hollow fibre kidney where you had to make each hollow fibre before the dialysis, you get some idea of what was involved. So I think the coincidence of three people popping up was inevitable, once Thalhimer had done his work. He was the guy I think we have to thank, even though he's practically unknown today. Again, I have written about him in *Nephrology Dialysis Transplantation* in the past, but it is he whom all our dialysis patients have to thank, I believe.¹¹⁰ It was heparin and cellophane that made dialysis practical, although Thalhimer did not invent it either.

Shaldon: I would like to come back to this problem of independence in dialysis. It was a dream and like many dreams it didn't turn into reality. I think the tragic state today, as we will no doubt hear later, is the abysmal percentage of today's patients who dialyze in the home worldwide; a problem perhaps not with technique but with the attitudes of people in welfare states who are perhaps more demanding than they used to be, or they are just older. For example, in Germany an organization I helped set up in the 1960s, the Kuratorium für Heimdialyse und Nierentransplantation, which was a specialized unit for home dialysis only, is today the largest provider of dialysis in the federal republic, with 19 000 patients, and less than 1000 of these are now on home dialysis.¹¹¹ I think

¹⁰⁹ Professor Stewart Cameron wrote: 'From 1929 cellophane sausage tubing had been used for dialysis in the laboratory and Thalhimer transferred to this idea to continuous flow dialysis in vivo. See Andrus (1929); Drukker (1989).' Note on draft transcript, 18 July 2008.

¹¹⁰ Cameron (2000b).

¹¹¹ Professor Stanley Shaldon wrote: 'In November 1966, I left the NHS and set up the privately funded National Kidney Centre in a house in Finchley, London, to demonstrate that dialysis could be done outside the hospital and that home training would be facilitated in a domestic setting. During the period 1966–68 this resulted in installing more than 30 patients in their homes for dialysis throughout the UK. Following this preliminary period of activity the National Kidney Centre preoccupied itself with placing patients on haemodialysis in various places in the world as far afield as Colombo, Ceylon, Sri Lanka; Narvik, Norway and Lagos, Nigeria. In addition it established training centres for home treatment, particularly in Germany at University clinics of Frankfurt, Goettingen and Hannover, aided in the establishment of the Kuratorium für Heimdialyse and was responsible for placing the first 40 patients on the home haemodialysis in Germany between 1969 and 1972. See www.kfh-dialyse.de/kfh/kfh-historie.html (visited 19 May 2009). See also Shaldon (2004).' E-mail to Ms Stefania Crowther, 21 July 2009.

Chris Blagg wrote an editorial in the *British Medical Journal* recently lamenting the fact that this country's attitude towards home dialysis seems to be following that of the rest of the world.¹¹² I don't believe that humans are not capable of doing this; I think the effort in achieving it seems to have switched now and it's easier to put patients into service units and provide them with someone to do the work for them.

Turney: There is also the issue of money that we haven't really spoken about. I am hoping that Netar Mallick and others will talk to us about money and politics, because it's quite interesting that the US figures show that home dialysis was decimated as soon as Medicare started to fund it and it became a very commercial thing.¹¹³ Also, although it's not within the period of our meeting, and I am going to be very specific about this, CAPD appeared to be a viable and affordable alternative to home dialysis.

Baillod: Firstly, CAPD is extremely expensive, especially if it is done badly. The reason why they don't do home haemodialysis is because the doctors and nurses are not prepared to spend the time teaching the patients. For someone to do home dialysis they need time and attention from staff who are short of time, because they have got to get on with the next job. It requires money too, as time to teach is expensive. Mind you, once you have taught the patient you get repayment for the time and effort, because, apart from the cost of the equipment, home haemodialysis is the cheapest form of dialysis treatment. It is a great shame that we rarely do home haemodialysis in the UK today.

Another comment about what dialysis did as regards the changing attitudes to patients: I remember clearly the business of sharing accommodation between males and females and we were having to defend ourselves to the matron. She was astonished that we had put a female patient with a male patient for dialysis. We said: 'Do you want her to die or do you want her to live? It's as simple as that.' We should look at that.

Hamilton: A very brief answer to the very important question that was raised earlier – why was dialysis not considered earlier than the 1920s and 1930s and then suddenly came to the fore? A very interesting and profound question. We should try and get back into the mindset of physicians and medicine in general in the 1920s and 1930s, which had an holistic view of disease. I think one of the

¹¹² Blagg (2008).

¹¹³ Nissenson and Rettig (1991). See also Blagg (2000).

answers is that it was considered pointless to treat the kidney because the kidney was simply part of a diffuse disease in the body. We take a totally different view now: treat the kidney and the rest of the body is fine. I think you go back to the writings of physicians in that holistic period and they regarded it as a diffuse disease and thought it pointless to attack only one part of it.

Turney: Many people who lived through it thought that the pivotal event in British dialysis history was hepatitis and its consequences, and the events of the time. I think we will ask Netar to lead in with the Manchester experience.

Mallick: We were talking about how dialysing nephrologists were created; Geoffrey (Geoff) Merton Berlyne, who really started dialysis in Manchester, was reader with Douglas Black.¹¹⁴ In 1965, when Douglas was on holiday, Berlyne opened up a couple of the side wards for regular dialysis as he called it. One couldn't get into the ward without passing these side wards, but there wasn't much space to clean everything up. Within a year there was a devastating outbreak of hepatitis that killed all six of the patients, a laboratory technician, one of the porters and one of the nurses, in rapid succession. Two distinguished physicians, Peter Ackrill and Jack Tinker, who are still alive, were also seriously ill at the time. The medical establishment in Manchester was not pleased by this, nor was the professor of medicine, Douglas Black. While that had a significant local effect, it also had a very significant national effect, because it occurred virtually simultaneously with the publication of the report of the working party which Hugh de Wardener chaired, which had agreed to set up a central initiative, 20 dialysis units across the UK.¹¹⁵ The government was going to fund these and, as far as one could see, fund the consequences. Though that particular commitment was met, nothing else was met after that, in terms of government interest in dialysis provision, and this completely kyboshed its development. There was an editorial in the *Lancet* at virtually the same time which didn't mention hepatitis, but pointed out that Hugh had worked out the cost, not significant in today's terms, but it raised the point that in the end, it's a matter of

¹¹⁴ See Anon. (1993).

¹¹⁵ The working party on intermittent dialysis of the Ministry of Health (MoH) was established in May 1965, following the recommendation of a MoH committee established in 1964 chaired by Lord Rosenheim. Records and papers of the working party are held at the National Archives, Kew, at MH150/7–20. See also Ministry of Health (1965); MoH (1966); Stanton (1999). An interview with Hugh de Wardener is freely available online at <http://cybernephrology.ualberta.ca/ISN/VLP/Trans/deWardener.htm> (visited 1 April 2009).



Figure 11: Professor Hugh de Wardener, (left) head of the renal unit at Charing Cross Hospital and Dr Anthony Wing (right).

economics.¹¹⁶ Did the country really wish to spend its money on dialysis or on something else? Of course, in the wake of the hepatitis outbreak, it was pretty clear what the answer was going to be for any government. So hepatitis had a huge impact on British medicine, because the devastating Manchester outbreak occurred at a time when critical central decisions were being made.

Shaldon: Yes, we had yellow units at the Royal Free, if I remember correctly.¹¹⁷ I think I can claim to be one of the first victims of that outbreak of hepatitis B and there was a segregation policy, which was never very well enforced in post-op yellow units. But then you got your vaccine and the problem sort of disappeared, didn't it?

Mallick: Hepatitis C came along after that.

Goldsmith: We had 55 patients with hepatitis B altogether at the Sefton General Hospital, Liverpool, but were lucky, no deaths. When I say 55 patients, only a

¹¹⁶ Five letters to the editor of the *Lancet* arising from the editorial, 'Profit and loss in intermittent haemodialysis' (20 November 1965), appeared on 11 December: Evans *et al.* (1965); Kerr *et al.* (1965); Blagg and Parsons (1965); Eady (1965); and Black (1965).

¹¹⁷ See Knight *et al.* (1970); Fox *et al.* (1971).

few were dialysis patients.¹¹⁸ Most were relatives of patients on home dialysis, technicians, nurses and a doctor. We were threatened with closure, but, of course, they couldn't do that. May I remind us that this was before we could tell which blood was infected, before the development of the Australia antigen test for infectivity and of a vaccine, and this led to obvious difficulties.

Bailod: We had most of our patients on home haemodialysis using leg shunts allowing them to be independent (Figure 13). It was expected that the nurses would put the needles into the hospital patients. We taught some of the home patients to insert the needles. Basically, each patient was independent. In late 1967 an drug addict patient was sent to us. He was very uncooperative and peritoneal dialysis soon failed. During haemodialysis he would often pull out his needles and spray everyone in the room, including new sick patients. The patients did not become sick, but suddenly staff were going off sick with hepatitis B. At about the same time the academic liver unit at the Royal Free was able to test for hepatitis antigen, but they were selective in who they would test. It was not until we insisted that all staff and patients were tested that we discovered that there were patients who were Australia antigen-positive, but appeared healthy. Included in this group was our drug addict patient, who announced that all of his drug addict friends with whom he had shared needles went yellow, but he did not. At this point we realized that it was the silent carriers who spread the disease and he certainly was our source.¹¹⁹ The first hepatitis casualty, Lesley Pavitt, who is sitting behind me, was quite sick. We did not have any deaths and, because of the testing available, we were able to sort out the problem and deal with it. It all seems so simple now.

Ogg: I think the Guy's epidemic (1969–71) was bigger than anybody else's.¹²⁰ I counted 125 cases; there may well have been many more. I am not aware that anybody died. But a colleague, Stewart Cameron, had a serum bilirubin that reached 16mg per 100ml, was very sorry for himself and didn't return to work for a long time.¹²¹ We didn't have the Australia antigen test and we had no idea who was carrying the virus. Most of the patients who got it were fairly well. The staff were obviously ill. One thing that astonished me was that we

¹¹⁸ See Hawe *et al.* (1971).

¹¹⁹ See Knight *et al.* (1970).

¹²⁰ Ogg *et al.* (1972).

¹²¹ Professor Stewart Cameron wrote: 'I was pretty convinced I was going to die.' Note on draft transcript, 11 July 2009.

continued to get staff coming to the unit. Doctors and nurses kept on coming in, which is greatly to their credit or lack of sense. I got very upset with the hospital administration because it failed to take responsibility for the health of agency nurses who got infected. Some poor girl would come in and do her bit, pick up our dreadful disease, then go away and be ill somewhere else. The hospital denied all responsibility for it. That upset me, but I couldn't do anything about it.

Turney: Just before we move on from you, what did Guy's do with their unit?

Ogg: We actually had an isolation unit built. By this stage testing for hepatitis was available and we could at least separate people who were Australia antigen-positive and Australia antigen-negative. We implemented most, if not all, of the Rosenheim recommendations.¹²² We worked very hard to put people who were positive on home dialysis, providing a major impetus for expanding our home programme. John Goldsmith also gave us valuable advice.

One of the factors that I think was responsible for maintaining our outbreak was the Kiil dialyzer. All of our patients were on Kiils and anybody who has used one knows that sometimes they leak. You do a lot of work to build a Kiil, sterilize it, connect the patient and then get a leak. You could either start again, rebuilding and sterilizing it in formalin before restarting dialysis, or you could use one of a pool of Kiils that were already assembled. I suspect that those were extraordinarily dangerous: it's amazing that we actually had that policy in the late 1960s, but we did. That epidemic was my point of contact with Eric Collins, because we were well into flat-bed dialyzers for our chronics, and Rhône-Poulenc and Gambro were the two firms who were producing disposable flat beds and it was for that reason that we switched to the Gambro flat beds.

Turney: Netar Mallick said that there was political and economic effect and you are saying that there was a practice effect and you changed to disposables, which of course dominate now.

Pavitt: As Rosemarie Baillod said, I was 'staff case one' in the Royal Free paper.¹²³ I was taken into the Westminster Hospital as an unwell member of unknown origin and the consultant came round the next morning and said: 'Oh, we have had your blood results back and you have got hepatitis.' Well, I went ballistic and said to the consultant: 'You have got to ring the Royal Free immediately.' He said: 'Now there, there dear, I don't think we need to worry them about

¹²² DHSS, England, Scotland and Wales (1972).

¹²³ Knight *et al.* (1970).

this.’ I had to get the trolley phone to ring the hospital to tell them, but by that time other cases had already come on. I thought that was very indicative of the attitudes of some paternalistic physicians in those days.

Professor Neil Turner: I am sorry that Ann Lambie can't be here today, but she spoke at Robin Winney's retirement in Edinburgh last year, at which time the story was told of the hepatitis B outbreak in Edinburgh in 1969/70, in which there were three staff deaths, including a transplant surgeon, a technician and a nurse, and eight patient deaths. Robin Winney told me later that no-one had ever dared to present that story in Edinburgh since the outbreak.¹²⁴ Getting people to talk about it after that interval made clear what an enormous impact it had had on the practices of the unit, which had been unable to take on any new patients for a long period. Suffering the deaths of colleagues in a very small unit at that time had an impact both on the people in it and on the perceptions of nephrology from the other specialties in the hospital. Very difficult to measure, but, I am sure, extremely important.

Turney: I think that's a very important point. Of course, Edinburgh had its own particular account, which was published by Colin Douglas.¹²⁵

Marsh: We opened our main regular dialysis unit at the London Hospital in 1968, having previously dialyzed a few patients between 1965 and 1968. We had virtually no problems with hepatitis at all. We were paranoid about hepatitis, having realized the problems in other units and so we were extremely careful in our dialysis techniques.¹²⁶ When the Australia antigen testing came along we got Yvonne Cossart to test all transfused blood, our patients weekly, and the staff, I think monthly, and we were absolutely meticulous.¹²⁷ We had one patient with hepatitis, and I think in the early days when we were testing for Australia antigen we had another two patients who became transiently positive, but it never spread. I don't know why, except that we were paranoid, having heard about the other units' problems. No staff were affected; perhaps we were lucky.

¹²⁴ See Bone *et al.* (1971). See also <http://renux.dmed.ed.ac.uk/edren/Unitbits/historyweb/Important%20events.html#anchor11592281> (visited 3 April 2009).

¹²⁵ Douglas (1975).

¹²⁶ Dr Frank Marsh wrote: 'Before it was possible to test all transfused blood for hepatitis we used nitrogen-frozen red cells.' Note on draft transcript, 7 August 2009.

¹²⁷ See Blumberg *et al.* (1968); Cossart (1971).

Hamilton: I have been through the Ministry of Health's files covering this period and, as Sir Netar says, they were just at that point of priming the pump for funding the units when the news of the hepatitis outbreak came through. I am sorry to say there's quite a cheeky note from Sir George Godber, the chief medical officer, saying, almost gleefully: 'After this news we do not need to turn off the tap of money, it will turn itself off.' It was a piece of cynical politics in the background of this.¹²⁸

There's just one other point: of course, editorials were unsigned and anonymous and the *Lancet* contributed to the anti-renal unit mood in the country at that time and it might be nice for the proceedings if the author of those editorials could be identified for posterity.¹²⁹ I think it is well known in the markets and in pubs who it was, but maybe it could be put in cold print.

Cattell: You talk about the economic consequences, but there were also serious social consequences. Stanley Shaldon has made the point that the nation was divided into units: those that had hepatitis and those that did not, and if you had a clean unit, you could not allow your patients to go on holiday. This was absolutely forbidden. Worse than that, we developed a mobile dialysis unit at one time, which some of you probably remember, and this was banned from the West Country, who didn't want our nasty, dirty renal patients there. Finally, it also had quite an important point, that if you had a clean unit, when Australia antigen testing came along, what did you do when a patient presented with renal failure, who was positive? I have to say that we had enormous help at Bart's from both Guy's and, I think, King's, both of whom would accept these patients so that we could stay clear of positive patients.¹³⁰

Mallick: I understand that my previous boss, Douglas Black, wrote that editorial.¹³¹ He was by no means anti-therapy, he just took what he thought

¹²⁸ See Hamilton (1984).

¹²⁹ Anon. (1965).

¹³⁰ Dr Chisholm Ogg wrote: 'Mr Mick Bewick contracted hepatitis whilst working at Guy's and was one of the few transplant/dialysis surgeons who was presumed immune to re-infection. He therefore offered invaluable help with surgical problems in infected patients from other units.' Note on draft transcript, 22 July 2008.

¹³¹ Professor Stewart Cameron wrote: 'I tried very hard to find out who authored the very influential *Lancet* editorials of 1965/6 on dialysis and hepatitis. My "suspect" was Douglas Black, but when I challenged him about this he said, "no", but rather evasively, and I strongly suspect he had some role in them.' Note on draft transcript, 18 July 2008.

was a rational view of it. His secretary told me that he had a letter from Robin Fox, editor of the *Lancet*, saying: ‘Since your article appeared we have had to move to the basement, because there have been so many comments flying in through the front door.’ He took what in many ways was the rational view at that time. It’s all right with retrospect, but it wasn’t so easy to see at the time.

By the early 1970s we had almost the same number of patients on renal replacement therapy as France and Italy, but 61 per cent of our patients were on home dialysis and in the Federal Republic of Germany and the rest of Europe it was about 20 per cent.¹³² We easily had the highest transplant rate, so this was the way that physicians tried to manage their patients in the face of government indifference and colleagues’ hostility. I have said this before, the fact that Stanley Shaldon had shown that home dialysis works saved the renal population on dialysis in the UK. It wasn’t what he intended to do, but that’s what he actually achieved in those years.

Baillod: I wonder if anybody has any comments about the hepatitis vaccine, because when the original vaccines came out they didn’t work for everybody.¹³³ For example, in our unit we were given the vaccine and when I suggested that we should test to see whether we had protection, I was told by the hospital that they did not do the test in their pathology department and they did not have the money to pay the academic liver unit to check whether I was protected or not. I made an enormous fuss to get the staff and patients checked and found that about 20 per cent of the people assumed to be protected did not have any protection. It wasn’t until better quality vaccines came out, up to five years later, that everyone got the protection they needed.

Turney: While we are discussing complications, shall we talk a little bit about aluminium and water? Because we have David Kerr with us and we also have members of industry and there are lots of aspects to the changing practice from aluminium.

Baillod: I always thought we were getting messages from David Kerr that he had some peculiar bone disease in which some of his patients were wheelchair-bound, because they were developing spontaneous fractures. We had one patient transferred from David, Olga Heppell. She got spontaneous fractures of her ribs when she leaned over her tank to clean it. I would mutter

¹³² See Parsons *et al.* (1974); Baillo and Moorhead (1974).

¹³³ Maupas *et al.* (1976).

under my breath: ‘It’s Newcastle water.’ In London we did not have this bone disease.

Kerr: We had this problem quite early, as soon as we started treating patients with chronic renal failure, and therefore they had a long exposure. Scribner kindly sent us two machines to let us do them and we only had enough places to treat two patients. They were doing very well after six months and Stanley Shaldon came to see us and he asked how the patients were doing. I said that they were getting on very well. There was one middle-aged lady, she was still fine, and there was a young lady who had been a nurse who grew up in Newcastle but had married an engineer in the south of England and then turned out to have chronic renal failure, and none of the hospitals around her would take her. She came back to Newcastle, thinking she was going to die, but her mother came to ask us if we would take her and so we took this lady in. Six months later, when Stanley came to see us, she was fine, except that when she got out to walk she got pain in the bottom of her feet. Stanley thought I was not treating her properly and that she had got neuritis. He was sure that he was right and I was sure that he was wrong. I said: ‘There’s something wrong with the bones’, and from then on we started seeing more patients with this. There was a young man who was going to university in Newcastle and he stepped out of his car one morning and fell on the ground. I happened to be standing there and I put him on a trolley and took him in to the hospital. We put him in an X-ray room and he had broken his femur, just getting out of the car. I thought: ‘We really have got a problem in Newcastle and it’s going badly.’

While we were trying to think what it could be, Mike Ward, who was in charge of home dialysis, came to me one day – by this time we were sending a lot of people out to be treated in their homes – and he said: ‘I have noticed that the people who have this bone disease are mostly from the north part of Newcastle and places beyond, while south of the Tyne very few of them seem to have this trouble.’ A very sensible observation and very important; it saved a lot of people. By this time we had been thinking it may be aluminium, but it might have been lots of other things. It wasn’t just in Newcastle; it was happening in Sheffield and in Plymouth and in many other places in the UK, as well as the US, Canada, Netherlands, and so forth. So there was something about it, but we never knew quite what it was. On that very same day I went to the waterworks on the north of the Tyne and saw them putting their aluminium sulphate into the water. Mike had made the statement, which I thought was very good, that to the south of the Tyne the hills were chalky and the water came from out of

them. In the north it is granite and what I was watching was removal of algae from that water by adding aluminium sulphate.

As I walked back, I thought: ‘If it is aluminium, why are we having it? Because when water goes through water softeners, the aluminium would be removed as well as the calcium and magnesium.’ So, that evening I got out three major books about water treatment and each of them said that aluminium was taken away by water softeners. I noticed it was only said because they had tested it by putting aluminium chloride through a water softener. I knew that aluminium chloride was not used for removing algae, so I thought it still could be aluminium. And I was right. It took us about two years to get rid of the aluminium in our water and Mike did a great deal of the work on that.¹³⁴

When we realized what it was, we went to a meeting of the International Society of Nephrology in the US to talk about it, and we gave a talk entitled ‘the demise of Newcastle bone disease’. All my colleagues had their names on this statement, and at the end of it, it was accepted.¹³⁵ However, not everybody believed that we were right, a lot of people still thought that aluminium was not the cause, although I thought we had proven that it was. Just after that, I went on a lecture tour across New Zealand and Australia, and when I got to Melbourne I gave a talk about aluminium poisoning and one of the audience was a professor of pathology who had been trained in the Hammersmith Hospital. After I had departed he went down to his room, picked up a book by his teacher at the Hammersmith Hospital and found there was a dye that shows aluminium. And so he took bits of bone that he had taken from people with bone disease and found the mauve line upon the ossification line which most of you know about now. Two weeks later I was back in England and opened the *Lancet* and there was his statement, and from then on everybody believed that it was aluminium and you could see it.

Dr Margaret Platts: In Sheffield, we were plagued with aluminium bone disease and encephalopathy, but our patients fell into two camps, those who had it and those who didn’t, and that depended on where they lived. Our region, as you probably know, goes right out to the east coast, and it was people near the

¹³⁴ Professor David Kerr wrote: ‘Michael Ward took on the job of setting up a new water purification machine for our dialysis unit with reverse osmosis, soft filter and a deionizer. He also persuaded the water unit to stop using aluminium for purification.’ Note on draft transcript, 6 August 2008. See Goodall (1974).

¹³⁵ See Kerr *et al.* (1986); Ward *et al.* (1978); Parkinson *et al.* (1981).

east coast who got this. They were all on exactly the same treatment, dialysis techniques and drugs and so on, and so it was naturally occurring aluminium in their diet or water that did it. This was before the time, of course, of the universal de-ionization of water.¹³⁶

Shaldon: I want to remark that the use of water softeners was a requirement if you were fortunate enough to have hard water and I think that aluminium bone disease and encephalopathy never developed in patients who were dialyzed with water softeners. Traditionally, Seattle had the gift of such pure water that they had no water treatment and those who ran into trouble with calcium in the early days quickly added water softeners and they never saw the aluminium disease. So, I think this shows the distribution of the kind of water before we ever understood what the causative agent was.

Blagg: Stanley is quite right. The only thing in our Seattle water was debris that came down off the mountains in the spring when the snow melted. Consequently, for the first ten years or so, we just filtered our water to remove them. It wasn't until Seattle city water was fluoridated in about 1970 that we began to use de-ionizers. David Kerr comes into our water story because in 1967 we had trained a high government official from Khartoum in the Sudan to do home haemodialysis. A year or two later I got a call from David, who was an external examiner at the University of Khartoum Medical School, to tell me that every time the Nile flooded his patient became hypercalcaemic.

Turney: We have skirted around home haemodialysis. We keep mentioning it. Do the protagonists of home haemodialysis want to take this up?

Mrs Ann Eady: I think there are possibly people here who may have quite a large contribution to make to this and there's one sitting behind me, Mary Selsby. While the doctors and nurses were training patients and their carers, there was an awful lot of work going on in the background with councils, new housing and plumbing. I am sure Mary Selsby, and also perhaps the patients themselves, will say how they felt because they were, after all, the reason for what we were doing.

Mrs Diana Garratt: I am a renal patient, started in 1969. This is quite an event for me, because normally when I am among clinicians, most of them were still

¹³⁶ Professor Stewart Cameron wrote: 'Dr Margaret Platts was one of the first – if not the first – to provide clear evidence of the involvement of aluminium in dementia. Her contribution has been neglected as she is very modest. See Cameron (2002): 261.' Note on draft transcript, 18 July 2008. See also Platts *et al.* (1973); Platts (1980); Platts and Anastassiades (1981).



Figure 12: An example of home haemodialysis equipment, c. 1965: with Cambridge pressure and heat monitors, a tank system for dialysate, water softener and liquid concentrate, sterilized with formalin.

at school when I was starting dialysis. Not today, however. It was January 1970 when Rosemarie Baillod came round to set me up at home on haemodialysis with my first shunt and I remember the room very well. We had a de-aerator, it looked like a toilet cistern, high on the wall above the bed (Figures 12 and 13). Actually, I think I was dialyzing on the table at that time, we hadn't organized the bed. The rest of the family went on around us; we had a small TV, my younger brother and sister and the cat, who went very soon after because it was sitting there watching the pulsating blood lines and that was very nerve-wracking, very, very nerve-wracking. We got through it, but it was an enormous effort. Every day you were either on the kidney machine, or you were hoping that the machine, which was not at all reliable compared with the modern machines, would work, that the kidney would not burst, that you wouldn't have a blood leak. I had terrible vomiting as well in those early days. My mother, Dr Jean Northover, may touch on that, because she was the one clearing it up. I will hand over to her now, because she was the one who did all of the work.

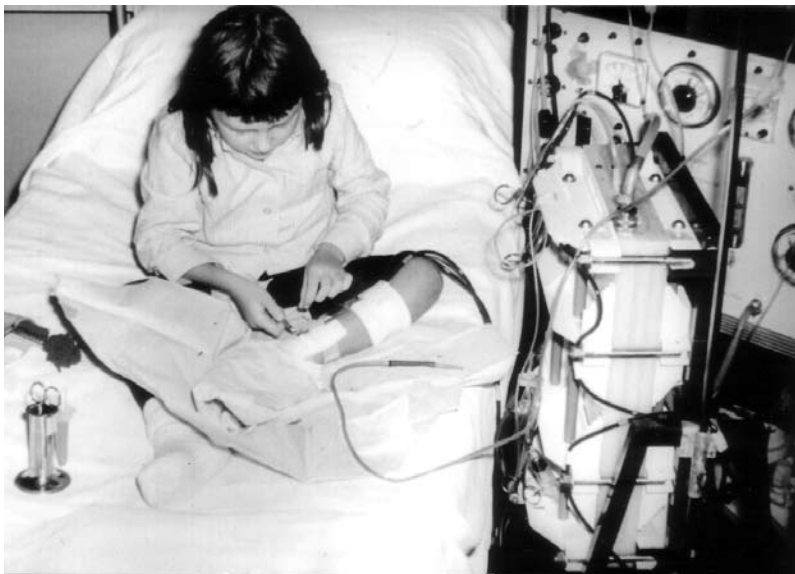

Figure 13: Diana Garratt, née Northover, 1969.

Dr Jean Northover: It is very difficult to talk about home dialysis and to avoid all the clichés, because so much has been said about it. When I look back on the pioneer days, it would have been quite impossible if we hadn't had the excellent backup that came from Lesley Pavitt and her nursing staff, and, of course, Rosemarie Baillod, who would come straight to the phone when required and thunder down the line what you should be doing, what you were doing wrong and then things would go right again.

We staggered on for the first two years, assuming that dialysis reactions were really par for the course and that the first thing to do was to ring up the renal unit and see if Piriton[®] was needed.¹³⁷ However, it got to the stage where the technicians were called in for sterilization of the water softener – this was used because we were in a hard water area in Hertfordshire – but that didn't work. The reactions continued. Then all the other bits and pieces of the equipment were looked at and I realized that the more improvements we made to the water path, the worse the dialysis reactions became. So I went and had a good read up; as a retired scientist I knew how to set about things. The medical library at the Royal Society of Medicine became very useful and quite quickly I got into the work of Dr Hugh Lyle and Jeanette Blomfield out in Australia, who

¹³⁷ Dr Jean Northover wrote: 'For sudden headache, chills, sweating, nausea, vomiting, and irregular fever.' Note on draft transcript, 18 July 2008. Piriton[®] is an anti-histamine now manufactured by GlaxoSmithKline.

were both looking at contamination of dialysis fluids.¹³⁸ I found that three years previously here in England, Dr Lyle had said that he had analytical facilities in his laboratory at Dista Products, Speke, which he invited people to use if they would like to send in their dialysis fluids, because he felt that there was a risk of copper contamination of these fluids.¹³⁹ So, of course, we took up the offer: dialysis fluids were sent off. By then, I have to say, that analysis was rather late in the day because Clifford Harvey, who is here today, and was formerly chief technician at the Royal Free Hospital renal unit, had already removed a 15-foot copper pipe from the water-path to the kidney machine. This had obviously been a good thing as reactions lessened. We had reduced the copper content, we imagined, of the incoming water. Nevertheless, the results from Dr Lyle's laboratory were very useful as they indicated that there was metal pick-up occurring inside the kidney machine.¹⁴⁰ Dylade were called in and replaced the copper-containing parts of the kidney machine with stainless steel parts and a installed cellulose Pall filter.¹⁴¹ We moved into an era when we were having no dialysis reactions. We had, in fact, rediscovered the wheel! We had done all the work checking the water and dialysate pathways and then made modifications, which we later found had been done by Manzler and Schreiner.¹⁴² There was nothing new in this.¹⁴³ However, we were then into clearer waters.

Next we had a charity chalet in Eastbourne with dialysis equipment and that was an area where a water softener was again required. Diana went down there. For the first days of the holiday she seemed to be alright. She had one small reaction but later she went back for another holiday and dialyzed, and had two massive dialysis reactions. I had taken polypropylene bottles with me for sampling the dialysis fluids. These were sent off to Dr Lyle at Speke and what he found was

¹³⁸ Lyle (1967); Blomfield *et al.* (1971).

¹³⁹ Lyle (1969).

¹⁴⁰ Lyle *et al.* (1976).

¹⁴¹ Pall Corporation was founded in Brooklyn, New York, in 1946 by Dr David Pall and began manufacturing blood filters for medical purposes in 1971. See www.pall.com/pdf/inv_pdf_Focus50Pt1.pdf (visited 20 May 2009).

¹⁴² Manzler and Schreiner (1970); Ivanovich *et al.* (1969).

¹⁴³ Dr Jean Northover wrote: 'In this connection Elga Group ((1969): 6–7) may be of interest. Professor George Schreiner, speaking about haemodialysis in the US said: "All copper parts have now been taken out of the commercially available dialyzers. I mention this because I have noticed here (in the UK) that some of the water lines have copper valves or copper-containing valves."' Note on draft transcript, 18 July 2008.

that the levels of copper in those dialysis fluids were something of the order of 500 micrograms per litre, which was comparable with those found in some of the Australian renal units.¹⁴⁴ Again, the dialysis set-up – kidney machine and water softener – was cleaned up and reactions were then a thing of the past. Of course, copper in the dialysis fluid at these levels is probably not lethal in the short term, although extremely unpleasant. From our point of view, running home dialysis, we were jolly glad when we got rid of these reactions, because Diana had two siblings and really dialysis had to be a normal part of the family pattern; it couldn't take priority. The other two children needed attention.

The last thing I would like to say is that the funny thing about home dialysis is that when we had got past the ten-year mark – we went on for about 16 years before Diana got a transplant in 1985 – what we found was that you worked so hard and you had so little rest, that when finally you'd finished with the dialysis, the Kiil was put on the local dump and the transplant was working, you couldn't really remember what you had been doing a lot of the time. So this was extreme, emotional, psychological and mental fatigue. I don't know what the two sides of the brain were playing at! But I kept a friendship going with another dialysis mother, and she said, 'I need you as my witness, because I have got to talk to somebody, I have got to know that we really went through it.' She suffered from the same thing. So when people say, 'Oh, go and learn French by total immersion', I have to say that what we learnt on home dialysis was certainly 'home dialysis by total immersion'.

Turney: I think that's very interesting. I wonder whether we can bring in Mary Selsby to talk about the wider aspects of home dialysis, because home dialysis was, as was pointed out by Netar Mallick, quite a transient British phenomenon and so it would be nice if we could dissect that a little.

Miss Mary Selsby: I returned to the Royal Free Hospital in 1970 as the dialysis administrator, having left in the mid-1960s after completing my registered nurse training. Dr Rosemarie Baillod had instigated the post to facilitate the rapidly increasing home haemodialysis programme. Rosemarie's reputation was garnered far and wide. At that point, we had patients all over the country, within a 250-mile radius, because we were looking after children.

Often the patient and their family were very grateful for the treatment and were delighted to be going home, but there were a number of aspects that I learnt

¹⁴⁴ Blomfield *et al.* (1969).

very quickly to come to terms with. Initial meetings with the patient and family were while the patient was hospitalized. I would briefly outline requirements for home haemodialysis and arrange a mutually convenient time to visit their home. I was frequently the last person any patient with renal failure wanted to meet, because when they met me it was confirmation that their renal function was not going to return, although they were always given this information by Dr Baillod prior to my first meeting with them. However good the doctors and nurses were at treating the patients, giving information and the best possible training, starting home haemodialysis was further confirmation that their kidneys weren't going to work unless they had a successful transplant.

In the early days, I had to liaise with the local authority. This was a nightmare because they weren't always very happy about meeting the costs of the adaptations. The home dialysis treatment room requires a mains water supply and drainage to facilitate effluent from the water softener and dialysis machine, waterproof flooring and shelving, and a separate metered electricity supply.¹⁴⁵ There were many incidents with local authorities that told me what they were prepared to do, but couldn't meet the cost, suggesting we treat the patient in the hospital: 'It would be easier and a lot cheaper.' Eventually, in the 1980s the change from local authorities undertaking the cost to the hospital meeting it was made, making life a lot easier.¹⁴⁶

However independent we made the patients, what went on in their homes was a different issue. Frequently the spouse or partner provided considerable support. Few homes have spare space, and in the 1970s the dialysis equipment was considerably larger than that used today (Figure 12). Has anybody any idea what one month, two or three months' supply of dialysis disposables is? Lack of adequate space to house the Dylade dialysis machine, water softener and Kiil board together with disposable dialysis supplies, salt and concentrate, might necessitate the building of an extension to the home or a cabin in the garden,

¹⁴⁵ See Grant and Whelpton (1974): 25. Miss Mary Selsby wrote: 'Some authorities were very sympathetic and rapidly undertook the work. Others were obstructive, delaying the commencement of home treatment, inhibiting the patient's return to work, school or family commitments and blocking treatment facilities in the renal unit. In fairness, some authorities did find the costs difficult to meet.' Note on draft transcript, 22 August 2008.

¹⁴⁶ Miss Mary Selsby wrote: 'The renal unit budget met all the costs of home dialysis, the electricity used in the treatment room, the telephone installation and renal charges, plus the cost of the two-monthly replacement of dialysis disposables.' Note on draft transcript, 22 August 2008.

usually with covering from the house to the cabin. Only adults used the cabins.¹⁴⁷ No patient was ever allowed to dialyze at home without a functioning telephone in the treatment room. Many of them had never had a telephone in their house and as far as they were concerned, a phone in the house was the harbinger of bad news. I really had tremendous trouble with a lot of patients on this score.

Patients were inordinately kind and very generous with their time and hospitality, but they were overwhelmed at having to cope; learning to dialyze independently at the same time as having adaptations done and equipment installed by renal technicians caused considerable strain. I liaised with Rosemarie, the technicians, the nurses and, of course, the patient: at no time was the patient ever not told exactly what was going to go on.

In the early days, the Kiil boards occasionally did not work, or very rare problems with blood access or equipment occurred and these could and did cause problems with employment for both patient and spouse. In the early days help with the extra costs for the renal diet has to be fought for. I won't bore you with the ramifications of fights to get attendance allowances.¹⁴⁸ The cost of home treatment to the hospital was certainly cheaper than hospital treatment and it was very successful for a majority of the patients, but the fights to get money for the patients were very difficult.

If anybody was likely to lose their job, I learnt to liaise very closely with unions and bosses, but never without the patient's permission. I also liaised with schools so that the children got back to their studies as quickly as possible. We were very fortunate at the Royal Free to have a superb teacher in the paediatric department who also liaised with the schools. We did have trouble with school outings as teachers wouldn't want to take a dialysis patient. I would ask: 'Have you got any asthmatics?' 'Oh, well, yes, but they are different.' 'No. They are more difficult

¹⁴⁷ Miss Mary Selsby wrote: 'The worst scenario would be having to re-house the patient and family. If this was necessary, the proximity of workplace, schools, public transport and extended family had to be taken into account. A major cause of anxiety to families was the possibility of having to change schools. In the majority of cases, space was somehow found.' Note on draft transcript, 22 August 2008.

¹⁴⁸ Miss Mary Selsby wrote: 'Little statutory help was available, the then renal diet was very expensive, help with travelling costs was meagre and social security benefits were not great. Fortunately help with costs of the diet and travel was finally instigated by the government. Applying for an attendance allowance was initially a minefield, frequently requiring at least three appeals. Unbelievably, re-applications were necessary even for children, fortunately legislation resolved the problems. Employing social workers specifically for renal patients has been of enormous benefit to patients and staff.' Note on draft transcript, 22 August 2008. See Gordon (1974).

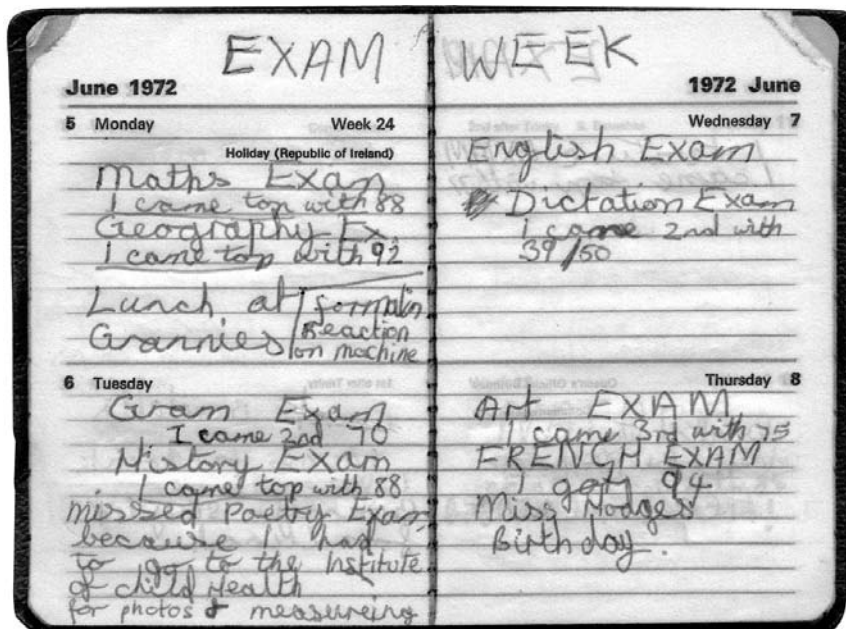

Figure 14: Pages from the diary of 11-year-old Diana Garratt, née Northover, for 5–8 June 1972.

to look after than a dialysis patient.’ We also had patients who would argue with teachers to be allowed to participate in sports and their teachers, being very protective, didn’t want them to do this.¹⁴⁹ It was a very rewarding part of working in the renal field. I have tremendous admiration for patients who undertook home dialysis, and certainly for their spouses.¹⁵⁰

Pavitt: I want to add something much more technical. Looking back on it as I was coming here, thinking about it, I am amazed at the things that we managed to tell patients to do over the phone. Jean Northover said that they would ring up and you would think, ‘Oh, yes, you are going to have to change your bubble catcher. Now, get eight clamps and this is how you start clamping.’ I think now I would

¹⁴⁹ Miss Mary Selsby wrote: ‘In the early days, patients were dialysing ten hours a night, three nights a week, and haemoglobin levels were pretty low, thus patients often did not feel wonderful...frequently it had been years, if ever, since the child had had sufficient energy to play sports, persuasion resulted in a tired but happy child.’ Note on draft transcript, 22 August 2008.

¹⁵⁰ Miss Mary Selsby wrote: ‘Home dialysis was and is very successful for the majority of patients, but it will not work unless the hospital provides the best possible medical care, reliable vascular access and training, maintained equipment, nursing, technical and social support. This was unstintingly available from staff of the renal unit at the Royal Free Hospital.’ Note on draft transcript, 22 August 2008.

wake up in a cold sweat thinking that I was dreaming, but then it was absolutely normal. The nurse on the evening shift was one of them, she spent most of the evening on the phone, troubleshooting for patients on home dialysis.

Garratt: A quickie on school, following on from what Mary said about school trips. I was always very popular on school trips because I didn't need to go to the loo. So, I would actually be the one looking after all the bags while others did. When it came to the academic work, because I did get round to some of that as well, I have in my diary for June 1972 – I was 11 years old at the time (Figure 14) – that on the Monday I had a really bad formalin reaction. The next day I went to school. There was an English grammar exam and I came second, and then in the afternoon there was a history exam and I came top with 88 per cent.

Professor Robin Eady: I suppose it must be a sign of age, because I mainly remember the more amusing sides of dialysis, rather than the really bad times. But I should mention that after a few years on unit dialysis I had had the full works of acute complications: from formalin up the line, hard water syndrome, dialysis disequilibrium, bacteraemia, the full lot. The main problem I had on home dialysis, which became a major burden, was pyrogenic reactions. The way we solved this was, I suppose, through accident rather than design. I was also a home dialysis patient in the US when I had a fellowship in the university, ten years after starting dialysis. I managed to find that we got rid of these reactions by having a different sort of water treatment, organized by Christopher Blagg. I was probably the first home patient to have reverse osmosis, which Rosemarie and the technical team managed to install in my house after my return to London. We have heard something about the problems of water treatment, or lack of appropriate water treatment, but perhaps what didn't come out was enough attention to what was happening in the water. We made a lot of assumptions, but I think that has already been discussed. That certainly was the major problem over the years for me, apart from those acute early problems.

Shaldon: I think this is an appropriate moment to pay some tribute to the dialysis nursing staff. As in my experience, many of them experienced nightmares on starting dialysis treatment of their patients exsanguinating from a disruption of the blood line. We have some people here who are well advanced in years, but I am sure not yet as old as some of the doctors, but would they like to confirm that?

Mrs Ann Eady: Yes, I am afraid so. One particular patient almost exsanguinated when I was on night duty and had left to check somebody else's drip rate or god

knows what. When I returned the whole wall looked rather like a Jackson Pollock painting, worse than that, it was absolutely terrible. He had a double blood pump, so not only one line was spewing out, but two were. It was a complete nightmare, not only for me, but for him. He did survive, but it was terrible.

Marsh: I am amazed that home dialysis was as successful as it was. The patients took an awfully long time to train; they were very highly selected in the early days of dialysis. In the early days we never took anybody over 50. We took one at 55 who was a GP, but most of them were white, intelligent and relatively young and even then it was an enormous stress on them. The social consequences were enormous, the marital breakdowns were quite considerable. I used to show a slide of a 'typical' successful home dialysis couple. The wife was absolutely gorgeous, the husband was wonderful. She eventually died and he came up to me and said: 'Frank, thank you for everything you have done, but home dialysis really is a nightmare.' And for many patients it was. Not only were there worries about blood spills, but it also provided an opportunity for some patients to commit suicide. I remember being called by the police to one patient in the Southend area and they said that she had died, having disabled the alarms on her monitor. I went down post haste to her dialysis room and I literally waded through an inch of blood on the floor in galoshes. It was horrible. So we did put our patients through an awful lot. They were chronic dialysis patients and there was relatively little hope of transplantation in those days. Later on there was greater hope of transplantation and home dialysis fell out of favour for a number of reasons, including that. Now, of course, transplantation is a major problem because there aren't enough transplants to go round. But I think that the nursing staff, the hospital administrative staff, the home dialysis administrators, the technicians and the patients really deserve a gold star.

Bailod: Soon after I'd said that we should select patients, I advocated not selecting but taking on everyone who presented to the unit; no one seemed to notice my change of opinion. The only people I would say I became selective with were children. I started looking after them from about the age of four and when they were at least ten kilos in weight. Weight was the more important factor for technical reasons. Age didn't matter and anyway paediatricians did not have a real age limit: if you are nice you can be a paediatric patient until 21, but if you are not nice you are transferred to adult units at 12. I was more careful in selecting children and families.

Obviously, there were patients who did not like or get on with dialysis. These patients had more accidents with their equipment, which always seemed to go

wrong. I was surprised by the number of patients who were illiterate. It was a learning curve to detect them as they were very good at covering up. They would not give you information if they had to write it down and if you pressed them they would get angry and make you back off. They were not stupid, but had just missed out on learning. They were quite able to dialyze themselves successfully. Also, I found the need to use different levels and types of speech within the English language in order to communicate and teach. The patients appreciate being able to talk to you on their level.

Quite a lot of patients who had been on home dialysis before having a transplant wanted to do home dialysis again after it failed, but it is not available for them today. I would not say that home dialysis was sweetness and light for everyone.

Booth: A general historical question: one cannot be anything but impressed by the sheer dedication and courage with which people have introduced this form of therapy. It must have been a dramatic, exciting period, but requiring immense dedication and commitment. The period you are discussing is a period during which medicine as a whole was dominated by numerical studies and epidemiology and that started, I suppose, with Bradford Hill and Richard Doll in 1950.¹⁵¹ It seems to me, listening to this story, that you are a group of people who have totally escaped the need to get your treatment approved by a Cochrane centre or a NICE committee. Is that in fact the case? Have you ever had to justify your activities to any of these protagonists of so-called evidence-based medicine?

Turney: Never, ever.

Mallick: Not so. NICE, in fact, did look at dialysis and came up quite positively about home dialysis, as it happens.¹⁵² But, I think Sir Christopher's point is well made. In the days when this mattered, thank goodness, no.

Turney: And there was a Cochrane review on bicarbonate dialysate, which said it wasn't very good; a bizarre conclusion.¹⁵³

Blagg: I agree with Rosemarie about much of what she's said. As you may know, we have managed to have a home haemodialysis programme in Seattle for many years. We originally started in 1964 and you may have heard the story about

¹⁵¹ See, for example, Doll and Hill (1954). See also Ness *et al.* (eds) (2002).

¹⁵² See NICE (2002).

¹⁵³ Roderick *et al.* (2007).

this. Les Babb was the professor of nuclear engineering at the University of Washington and in 1963 he began working with us to improve our dialysis technology. He took one look at the tanks we were using for dialysate and said we were stupid, and he and his engineering staff developed a proportioning system to make dialysate from concentrate and water for our four-station dialysis unit at the university hospital. When a 15-year-old daughter of one of his friends developed renal failure from systemic lupus erythematosus (SLE), she was turned down by the Seattle Artificial Kidney Center because she was under the age of 18 and had a systemic disease. Les and his staff started a crash programme to adapt the proportioning system for home use, and by the summer of 1964 Caroline was dialyzing successfully at home using a single-patient monitored proportioning system that was the forerunner of most of the dialysis machines we have today in both centres and homes.¹⁵⁴ Caroline lived for four years, finished high school and had two years at the university before dying of complications of her SLE.¹⁵⁵

Rosemarie talked about patient intelligence. We studied 100 consecutive patients whom we successfully trained for home dialysis and had a psychologist, Willard Snow, measure their IQs.¹⁵⁶ The average was about 102 and the range was from 87 to 147. The psychologist said that's just where it ought to be, as you don't train people of really low-level intelligence to dialyze themselves. The IQ of 87 may have been an error because the patient was an 18-year-old black man and I suspect it was really educational deficiency, rather than anything else. He dialyzed at home successfully for four years until he got a transplant and it wasn't until then that we discovered that for the last two years he had been dialyzing himself alone as the person who had been helping him quit after two years.

We have also compared the demographics of our home haemodialysis population with those of all dialysis patients in Washington state and all US dialysis patients.¹⁵⁷ The age distribution and other demographics are very similar, except that we have a much smaller black population in our state than nationally and so have fewer patients with hypertension as the cause of their renal failure. I

¹⁵⁴ See Babb (1995).

¹⁵⁵ See Eschbach *et al.* (1966); Blagg (2007).

¹⁵⁶ Snow and Clark (1976).

¹⁵⁷ Professor Christopher Blagg wrote: 'This is data I collected for a lecture and so it has not been published separately, but is included in Blagg (2005).' Note on draft transcript, 8 July 2009.

think many more patients are capable of doing home haemodialysis than are doing so at present. I used to tell patients that if they can drive a car, they can drive a dialysis machine; in both cases you have to learn how to use it, how to handle problems and know where to get advice and support, but you need know nothing about what goes on inside the awe-inspiring machine. Obviously, there are many reasons why patients may not have access to home haemodialysis or may not wish to do so. I think that with modern equipment there is much less pressure on whoever helps the patient and more patients today are doing all or almost all of the dialysis themselves. To our mind, the patient should do just about everything that he or she can.

Back to a comment Stewart Cameron made earlier about diabetes; Scribner always said that dialysis patients, in fact all patients with chronic disease, should learn as much as possible about their disease and take as much responsibility for their own treatment as they could. He said he learnt this from a diabetologist at the Mayo Clinic when he was a fellow there.

Pavitt: A quick comment: as somebody who spent nearly 18 years teaching patients how to manage their own dialysis at home, I would far rather have a patient who wasn't very intelligent, because they did what they were told; the more intelligent ones would argue with you.

Greenwood: A couple of questions, if I may: first, a comment for all the people who may be gloomy about what my generation has done to dialysis. I think there will be a resurgence of interest in home dialysis now, because of the need to do more frequent dialysis as a means of delivering more dialysis to improve survival. I saw my first kidney machine in 1978, so I am very much a latecomer. One of the complications that seemed to be apparent in patients then, which we used to send to the rheumatologists, was called 'dialysis shoulders'. I use this term because this often used to come back as the diagnosis. Were the medical teams of the 1960s and 1970s aware that there was this long-term complication, later identified as dialysis-related amyloidosis?¹⁵⁸

The second question: did anybody have any concept in those days of the massively accelerated trajectory on to cardiovascular events suffered by most patients and even by young people on dialysis? As a senior house officer, I don't recollect it entering my head how great the risk was. It is now a major concern, particularly in people who don't get transplanted. I didn't want to miss these two points in our history.

¹⁵⁸ See Assenat *et al.* (1980); Bardin *et al.* (1986) and page 75.

Blagg: A quick comment regarding Roger Greenwood’s question about cardiovascular complications. It wasn’t until the early 1970s in Seattle that we saw the connection, even though the very first Seattle patient died after 11 years on dialysis with horrible coronary arteries and vascular disease. The first paper on the subject from Seattle was not published until 1974, so we were completely unaware of it early on.¹⁵⁹

Shaldon: Perhaps we were more aware of it in the UK. I grew up as a liver doctor, as I said, and one of the most important aspects of diet was to teach patients how to have a salt-restricted intake with their liver disease. So it came as no surprise when we started dialysis that when we wanted to treat these patients adequately, they were all put on a low salt diet and this has subsequently and remarkably come into disuse, particularly in this country and other Nordic countries, for various reasons. It’s incredible when you read in the *British Medical Journal* only last year an excellent article by Nancy Cook, with an enormous amount of publicity worldwide, on the benefits of a low salt diet in pre-hypertensive normals, with a highly significant reduction over a ten-year follow-up of cardiovascular disease, how the use of a low salt diet has virtually disappeared from the treatment of dialysis today.¹⁶⁰ I think there is a large influence of ‘big pharma’ in this, in the belief that you can do it all with pills rather than via regimen.

Turney: We have skirted around selection. Clearly there was major selection or de-selection of patients in this period. Of course, the patients that were selected might be expected to have less cardiovascular disease than the 80-year-olds nowadays and might be more amenable for home dialysis. Does anybody want to get into this murky water of how patients were chosen, referred or not taken on?

Baillod: The fact was that when we were referred patients, most had been pre-selected by the hospitals and GPs who had decided others were not suitable. Even if you decided you would treat all patients, someone else had pre-selected them down into a narrow group. Even early on we treated diabetics and blind patients, but they had to fight their way through.¹⁶¹ What you have to remember is that all the patients had to fight very hard to get through to a dialysis unit.

¹⁵⁹ Lindner *et al.* (1974); Lowrie *et al.* (1974).

¹⁶⁰ Cook *et al.* (2007).

¹⁶¹ Professor Stewart Cameron wrote: ‘We did not really talk about diabetics, and how initially they were almost totally excluded. This story is told in Cameron (2002) but also in more detail in Cameron (2006): 575–87.’ Note on draft transcript, 18 July 2008. See also page 73.

Hoenich: Looking back, I think there is no doubt that the patients who actually appeared on dialysis were a totally different population from those we see today. If you go back and look at the figures – and I know that Rosemarie has just said that they were taking diabetics – around 5 per cent of the total population of patients on dialysis in the UK were diabetic, compared with around 35–40 per cent today. I think Stewart Cameron will correct me, but there was also this implicit censoring, you know: ‘If you are over a certain age, well, perhaps this isn’t the best possible treatment.’ There was never any overt censoring in the same way as there was in the US where they had a committee to decide and Robin Eady spoke very eloquently about this at the Renal Association meeting the other year. I often sensed that we probably saw the best of the bunch progressing on to dialysis.

Goldsmith: In the early days, the early 1960s, when we had to be highly selective, our only criterion for acceptance was: ‘Can we get this patient back to work?’

Blagg: I would say that the Seattle Artificial Kidney Center programme was responsible for the anonymous selection committee that everybody worries about, and still thinks about.¹⁶² It was probably the first time triage was overtly done in civilian practice, other than when disasters occurred, but according to Professor Al Jonsen in his book, *The Birth of Bioethics*, the publicity following an article in *Life* magazine in 1962 was the stimulus that led ultimately to the development of bioethics as a discipline.¹⁶³

We didn’t use the committee after about 1969 as we had enough support from the state of Washington and private insurance companies, so that we were able to take everyone referred to us at that time – but we had almost no diabetics then and very few patients over the age of 65. In 1972 at the International Society of Nephrology meeting, I boasted that in Seattle we were treating 45 new patients per million of population, that 90 per cent of our 130 or so dialysis patients were on home haemodialysis and most were rehabilitated and we were not turning anyone down.¹⁶⁴ Then, in 1973, the doors opened when the Medicare end-stage renal disease (ESRD) programme came in, providing universal entitlement to almost all patients with chronic renal failure, and diabetic and elderly patients flooded in.¹⁶⁵

¹⁶² See Haviland (1965); Darrah (1987).

¹⁶³ See Jonsen (1998): 211–14; Alexander (1962). See also National Kidney Disease Foundation (1963); Reynolds and Tansey (eds) (2007).

¹⁶⁴ Blagg *et al.* (1972).

¹⁶⁵ See Nissenson and Rettig (1999).

Turney: And it's now, what, 200 per million?

Blagg: In the US it's more than that. The incidence rate in 2005 was 347 per million population and the prevalence rate was 1569 per million population. We accept almost anybody and everybody now, whether they should be treated or not.

Professor Monty Losowsky: I wanted to make what is essentially the same point. I remember a time, quite a brief time, when I was a consultant in the 1960s, when there was what we might describe now as the 'Herceptin syndrome' where we were forced to think about value for money, or cost effectiveness.¹⁶⁶ Medicine was less specialized in those days, so we used to look after a range of people. I am not a renal physician, but I remember having a young man with chronic renal disease and we were hoping to get him on to dialysis, but he had been ill ever since his schooldays. He had never had a career, he wasn't married, he had no dependents and so we were told that it was unlikely that funds would be found for him. We were trying to work out a case, which is the sort of thing that we try to persuade NICE about now in other directions.

Platts: We always had totally inadequate physical facilities for the number of patients who were referred to us and we had to have some form of selection. We tried to be totally unemotional about it. There were some people – not a good thing to say – who were obviously unsuitable. But we made it age-related, and anybody over 40 didn't have a chance. That was in the early days.

Miss Freda Ellis: I had the privilege of working with Frank Parsons when I was a ward sister in Leeds in 1957. Chris Blagg might contradict me on this, but I think Dr Parsons' feeling was that it should be 'first come first served'. We had only one machine and I asked him how he decided which patient would be treated, and he said: 'If the dustman comes before the duke, the dustman gets treated.' I can't remember there being any age discrimination.

Blagg: In Seattle in 1962 the age limits for treatment were between the ages of 18 and 45, eventually extended to 50. But remember, the committee also used 'social worth' as one of the factors, and it has been said that if Henry David Thoreau had been referred for treatment, the committee would have turned him down.¹⁶⁷ It's also important to remember that in the early days there were very few opportunities for this expensive treatment and too many excellent

¹⁶⁶ See Blagg (2007).

¹⁶⁷ Sanders and Dukeminier (1968).

candidates, so the selection issue was very difficult. For example, Scribner estimated in 1964 that there were no more than 50–100 patients on transplants plus chronic dialysis in the US and the situation was unprecedented.¹⁶⁸ Joe Eschbach and I ran a programme from 1965 to 1969 to train patients who could afford it to do home haemodialysis and then return home to other cities in the US and to other countries. The experience with the patients from abroad showed that home haemodialysis patients could be managed at distances of up to several thousand miles from the training programme.

Ogg: One of our selection criteria was whether the patient could go on home dialysis. We had very tight hospital facilities and if there was no prospect of training a patient to go on home dialysis, this was a major factor against their selection.

I would like to make two very brief points about home dialysis. The first is that I have a sneaking feeling that it is the best way to get really good dialysis. The economic and space pressures on units is such that we have designed numerous formulae to calculate the minimum amount of dialysis a patient needs in order to survive. This never made much sense to me. But the days when you could dialyze somebody for ten hours, three times a week in hospital have gone and it is now only practicable at home. The hospital facilities simply aren't there. I think it's significant that we have two patients in the room who between them have got 40 years of dialysis experience, nearly all of it at home and not in hospital.¹⁶⁹

The other point I wanted to make was about a device that I think has been underestimated in terms of its importance in dialysis and which I have always attributed to Stanley Shaldon, and that is the pressure monitor on the bubble catcher. It seems to me that relatively unattended dialysis, or home dialysis, would have been inconceivable without this simple device.¹⁷⁰

Shaldon: Historically, we had to teach the Americans how to do overnight dialysis with a simple monitor in the days when it all started in the home, I guess, or in the hospital in those days. I remember when Merrill's group put their patient in the home, there was a famous meeting in Seattle in 1964; it's actually written

¹⁶⁸ See Scribner (1964).

¹⁶⁹ Professor Robin Eady and Mrs Diana Garratt.

¹⁷⁰ Professor Stewart Cameron wrote: 'I think Jo Joeekes was the first to realize the importance of pressure in this part of the circuit, and modified the early Kolff drum dialyzer in 1947 or so to incorporate a pressure check.' Note on draft transcript, 18 July 2008.

down.¹⁷¹ I told them that when George VI had had a thoracotomy they had turned Buckingham Palace into an operating theatre and that's what I thought Merrill's group were doing with home dialysis at the time. They had a doctor and an acute dialysis system done in the home. I think that we – for simple reasons of no money, no staff and wanting to dialyze long hours – used the knife and just had a very simple device, originally a mercury U-loop manometer that could detect changes in pressure in the blood line system to pick up either a disruption or, when you had a pumpless blood flow system, a drop in the patient's blood pressure.

I would like to come back to one last remark, on which Netar Mallick probably has data. It's my impression, and I have worked in three European countries, that there is no question that the rationing of dialysis mentality in the medical profession still exists in this country, compared with elsewhere in Europe, especially if one assumes that the incidence of end-stage renal disease is the same in the UK as it is in most western European countries. I still cannot understand how one can complacently sit back and, indeed, even publish today (as a certain group have published on geriatric ESRD) that it's better to let them die than put them through the hell of dialysis. I think I am perhaps exaggerating the paper, but there is a plea not to dialyze old people. I am becoming old and I still want a few more years of life and this sort of stoical attitude, which is very characteristic, I think, of the Norwegians more than the British, to say: 'Stand over, old man, and let the young have the best', is still prevalent in this population in the UK.

Turney: Previous speakers did hint that a lot of the selection happened before they reached the nephrologists in this specific case. The diabetics just didn't exist. Maybe this is something that we haven't got time to explore very clearly.

Blagg: Our first diabetic patient was treated in 1969 and over the next two years or so, we treated a total of 12 diabetics and only four of them did well.¹⁷² Of course, everything changed in the US in 1973 when virtually universal entitlement came along with the Medicare programme. I also want to make another comment: Stanley has made many great contributions to nephrology but, I think that telling us how to do home haemodialysis overnight, three times a week, was perhaps his greatest. Once we adopted this in Seattle in 1965, most of our patients were well rehabilitated, went to work or school or undertook

¹⁷¹ Shaldon (1964).

¹⁷² See Blagg *et al.* (1971).

other useful activities. Our state's department of vocational rehabilitation was so impressed that they became our greatest financial supporters in about 1967, paying for training, equipment and supplies for home haemodialysis patients. Of course, these were a selected group of patients. Also, one of the arguments we used with Congress to get them to legislate the Medicare ESRD programme was that most patients would be treated by home haemodialysis or a kidney transplant and would become taxpayers again. Little did we know what was to happen as a result of the entitlement and Congress completely underestimated what the costs would be. In fact, later that year, the *New York Times* ran an editorial about the unexpected costs of the programme and entitled it 'Medicarelessness'.¹⁷³ Also, people have forgotten that the use of nocturnal dialysis first came from Stanley, but over the years its use declined to very low levels. Now many nephrologists think it was invented in Toronto about 13 years ago – but what they developed there was more frequent nocturnal haemodialysis – often called nightly haemodialysis.¹⁷⁴

Mallick: Stanley makes a point that I was thinking of making myself, that it is strange – and I am observing this without having to be intimately involved with it – that the number of patients taken on dialysis in the UK still remains low relative to population, and we have heard from people in this room who have used the methods of selection which are much more overt than how it is being done now. It is much more covert, but some sort of quizzical attitude to this, a questioning attitude, must still remain in the UK. How it is going to be teased out, I don't know, but I would concur with Stanley's basic point that there is a mismatch between what is taken on in the UK and what would seem to be the European norm for incidence, but interpretation is difficult.¹⁷⁵

Baillod: I know about the U-tube with the mercury as Stanley had me go to Radio Spares to buy the little lights that flashed and a bell that would ring and I had to wire it up for him in 1964. We used it to measure negative pressure in the dialysate.

¹⁷³ Anon (1973).

¹⁷⁴ See Uldall *et al.* (1996); Shaldon (2009).

¹⁷⁵ See European Renal Association (2006): 22. Professor Stewart Cameron wrote: 'I don't agree. Some countries (e.g. Scandinavian countries, especially Denmark) have had completely free access to ESRD treatment for decades, but still find less than 100 per million population (ppm)/year with ESRD coming up. Others, such as Belgium, have three times this. Old UK post mortem data suggest 130 ppm/year for the UK in 1960, which, adjusted for diabetes and aging population, is just about what we are getting today.' Note on draft transcript, 18 July 2008.



Figure 15: The hand of a patient on dialysis for more than ten years, who had pain, stiffness and age-related carpal tunnel syndrome, c. 1985.

I wanted to talk about two points that Roger Greenwood brought up when he was talking about the development of amyloid and bone disease. I used to do six-monthly X-rays on all the patients. I recently checked up on the papers we published. In one paper we had looked at the X-rays over a ten-year period and picked up on all the various points like atheroma, erosions and calcifications.¹⁷⁶ We referred to it as calcifications, rather than atheroma. We were making the observations. We knew vitamin D did not work and we were looking for other tests to measure what was happening with the bone disease. You see, one of the things we have not mentioned was that it was not routine to measure cholesterol and it was very difficult to measure parathyroid hormone in the 1970s. Gradually we were able to make things fall in line. I gave a paper on the effects of dialysis in 1978.¹⁷⁷ I had 71 patients who had been on dialysis for at least ten years. I described the pain they had in their shoulders, the stiffened hands and the knees being hot. This was amyloid developing over the ten years. We knew about the problems, but could not interpret them.

¹⁷⁶ Tatler *et al.* (1973).

¹⁷⁷ See Baillod *et al.* (1980).

Cattell: I would like to make a more general observation. I understand the object of this exercise is to record people's experiences before we fall off the perch. One of our problems is that we all know how it was, but if you take the historian in 20 years' time, he really wants to have an overview, and I would make the point, which I touched on earlier, that dialysis, especially home dialysis, changed the face of British medicine. It introduced the nurse specialist, teamwork, particularly in the home, as Mary Selsby has said. It introduced informality between staff, nurses and doctors, and it gave patients the chance to have their say. This really was a huge change in the manner in which health care was delivered in this country.

Turney: I think that's a very important point. I remember the first time I was addressed by my first name by a patient, I nearly fainted. The temerity! But, of course, it's now routine. Nobody has surnames or titles in hospitals now.

Greenwood: I don't want to jump to the defence of my generation yet again about the attitude to dialysis, but I think there is a danger in measuring the success of renal services by the numbers of patients on haemodialysis, particularly in the renal centre. Many of us have realized now that the intense medicalization of the frail elderly and those carrying a heavy burden of disease is sometimes inappropriate. We are very blessed in this country to have an holistic attitude towards health and many of the units in the UK run very successful conservative management programmes in which patients are given the choice not to dialyze if the experience is likely to be too much. It has been shown that survival on dialysis in high-risk patient groups is no different from survival without it.¹⁷⁸ So I think we have to be very careful and maybe a better measure of success is the number on self-care, by peritoneal dialysis or haemodialysis and the presence of a palliative care programme. We in the UK still have a chance not to allow the wholesale industrialization of haemodialysis by commercial companies, which is a very different role now adopted by industry from that of the gadget companies such as Gambro UK, which Eric Collins used to run. As we are approaching the era of reimbursement in this country, it is a serious possibility that we will end up like the US, where everybody tends to go on to haemodialysis 'whether they should be treated or not'. That would be a tragedy. It's been very interesting listening today. Everything we experienced in the 1960s and 1970s tells me that we cannot compare the dynamics of what is happening in health care now with what was happening then.

¹⁷⁸ Smith *et al.* (2003).

Professor Robin Eady: A brief comment and then a question. Years ago Ann and I went, and we continue to go, to Sicily for holidays. I went for a conference there and had wonderful dialysis. They were starting a patient in her eighties on haemodialysis and they said: ‘Why not?’ In fact, they said: ‘She may not have many years to live, but we have many patients of this age, and they do reasonably well.’ I wouldn’t have been able to get dialysis in this country at the age I am now in those days. My question is really more philosophical, and I think we have to address this in this looking-back type of meeting: is dialysis today any better than it was at the time we are talking about, when we had home dialysis overnight three times a week for those lucky patients? Is it really any better today?

Shaldon: I would like to object to Dr Greenwood’s comment. This is a type of attitude that one is seeing coming out of the UK more and more. As a Brit who has lived outside this country for the last 34 years, I find that this is a kind of an excuse-game that comes upon chaps when they are too old: ‘Let them die, they will be happier.’ I am not sure that this god-like decision-making of consultant medicine in this country should be tolerated. I think dialysis now should be a trial-and-error situation. But to say you are too old, because you are old – except if you happen to have your wits about you and be a member of the medical profession – is very selective and a little bit god-like. I totally disagree with your remarks about not treating old people.¹⁷⁹

Cattell: May I make one amusing point? Diana Garratt made me think about it. Many years ago, in 1971, the European Dialysis and Transplant Association held a meeting in East Berlin, which many people here attended. In those days it was of interest to go to Checkpoint Charlie on the East German side. Now the only loo at Checkpoint Charlie was on the West German side, and one Robin Eady persuaded the East German guards to allow him to go to the Western side to empty his bladder, in which, of course, there was no urine.

¹⁷⁹ Dr Roger Greenwood wrote: ‘It is worth noting that the acceptance of elderly and diabetic patients on to dialysis, which is much more liberal now than it was in the 1960s and 1970s, is no different in the UK from other European countries, evidenced by similar age and co-morbidity profiles of the renal replacement therapy programme. My previous comments were referring to the choice which is now given in many UK centres to the frail elderly, to patients approaching the end of life and to patients carrying a heavy burden of co-morbid disease not to dialyze if treatment is judged, by them, likely to be harrowing and futile. This is regarded by many as a positive achievement of multi-professional team working, which still survives in the NHS and which we can see from the proceedings, was probably originally introduced several decades ago by Stanley Shaldon and many of his colleagues present at this seminar.’ Letter to Mrs Lois Reynolds, 2 August 2008.

Turney: I see dialysis patients have to be continuously inventive. I am going to draw the meeting to a close now and thank everybody for your contributions. I hope that you found it interesting and a chance to go down memory lane, but also to think about what times were like then and how those times have formed the way the specialty in dialysis is now. Thank you all for your contributions and, you never know, we may get a follow-up meeting.

Tansey: May I reiterate the chairman's thanks to you all for coming and contributing to this meeting. It's been a fascinating afternoon. I have certainly learnt a lot. You are absolutely right in the comment that was made earlier, these are very valuable resources for future historians and so I do thank you all very much for coming and I thank our chairman for holding the meeting together so well. Thank you, John.

Appendix 1

Reminiscences of working with the Kolff rotating drum dialyzer at the Hammersmith Hospital, c.1947–1952

From Professor Kenneth Lowe¹⁸⁰

Lying in the desert (in Egypt on transit back from service in India) one day waiting for demob, I was reading the *British Medical Journal* and saw an advert for junior posts at the Hammersmith Hospital. I cabled my wife to apply on my behalf. Early in 1947 I arrived at the Hammersmith; in some ways a 30-year-old veteran with an independent outlook, but I had to start at the beginning again. I attended Eric Bywaters' rounds and I admired him. Graham Bull had arrived from Cape Town about the same time and I got to know him casually.... When that six months as resident to Russell Fraser was up, I became one of the outpatient physicians and waited – but for what? Then *chance*. We juniors were all friendly and would meet in a club for a sandwich lunch and coffee. And so it happened that one day Jo Joeekes asked me if I would be interested in joining him to work on the artificial kidney. Bywaters was leaving and Bull would be in charge. It meant three to four years of security of tenure if one showed research potential. Bull readily agreed. We became great friends. (24 December 2006)

It is amazing that the Hammersmith managed to do important research, especially on the heart, kidneys and liver, with modest resources. Britain was bankrupt after the war and still repaying Lend Lease. America was not a generous ally. The artificial kidney had to be improved where funding was available in rich countries. (3 November 2006)

Poor Britain had sold its foreign assets and was bankrupt halfway through the war and dependent on the US (Lend Lease) and then Marshall Aid postwar – at a cost. Rationing was at its worst postwar. We all had a very cold winter 1947/8 (coal shortage). It was well into the 1950s before there was much improvement. (12 November 2006)

There was so much to be done in the postwar period that priorities had to be set and dialysis for some time had a relatively low priority. (20 February 2007)

¹⁸⁰ Excerpts from a number of letters written in 2006/7 to Dr John Turney. The letters are wide-ranging, but these extracts are limited to Professor Lowe's recollections of the use of the artificial kidney and the development of the conservative regimen for acute renal failure at the Hammersmith Hospital.

A case could be made out for research funding to further develop the Kolff prototype in the UK wherever it would be of primary interest in a hospital that had technical help and possibly the prospect of commercial development. It was all a question of what priority should be given by funding policies. Perhaps too low a priority was accorded to dialysis in the UK in the early 1950s. (6 March 2007)

Very little clinical research was done in teaching hospitals. The Hammersmith was almost unique. It had staff members with brains and energy, but resources were meagre. We had a nurse/technician in the catheter lab and we got a BSc graduate, Barbara Evans, who learned to use the flame photometer. I wasn't aware of any technical or light engineering available to improve the artificial kidney. (2 April 2007)

I suppose I was not impressed by the prototype artificial kidney. Improving the artificial kidney would need engineers, chemists and technicians of a high standard. Having travelled in the US, I no doubt expected the artificial kidney would be improved there. (24 December 2006)

I never foresaw the development of chronic dialysis and I didn't think much would be lost in waiting for the US to make efficient artificial kidneys. Acute tubular necrosis wasn't all that common in peacetime. (2 April 2007)

It was the time when the prototype artificial kidney was beginning to show all its defects. But we were getting a lot of cases of anuria referred to us and I would spend the next three years doing renal clearances, studying the cases clinically and taking up Bull's idea about tube feeding a synthetic diet and generally getting a better recovery rate in our patients. (24 December 2006)

The success of the Borst–Bull regimen in reducing the mortality from acute renal failure by careful medical and nursing care and especially by advising against mismanagements common at that time, was widely accepted. However, it was also agreed that improved artificial kidneys might/would further reduce the mortality. (6 March 2007)

The Borst–Bull regimen was saving lives and we wrote our *Lancet* paper in 1949 almost as an emergency, so that other medical units could experiment with it and reduce their mortality rates, hitherto in the region of 90 per cent.¹⁸¹ More important was our paper in *Clinical Science* in which we gave the first clear account of the pathophysiology of acute renal failure in the group of cases to which we

¹⁸¹ Bull *et al.* (1949).

applied the name ‘acute tubular necrosis’.¹⁸² We gave an account of our methods of assessing renal blood flow, glomerular filtration rates and tubular function. (19 February 2009)

I don’t think the Bull regimen was ever considered an alternative to dialysis. By ‘conservative management of anuric uraemia’, we proposed better clinical management as a holding operation. We were giving a clear account of the clinical picture of anuria or acute tubular necrosis, researching the pathophysiology and presenting a method of management that would reduce the mortality considerably. The implication was that the prototype Kolff kidney needed to be improved and problems of available antibiotics and heparinization overcome. That would be accomplished where facilities and funding could be provided. For that reason Kolff went to the US. Our two papers were well received and, I think, advanced the understanding and management of anuria. The Bull regimen, with or without modification, was widely used – by Kolff himself, Hans Brun and others. (12 November 2006)

The Kolff artificial kidney was a brilliant invention, but did it save lives, or save more lives than it endangered? Kolff’s ‘success’ was a sulphonamide anuria and these cases usually recovered unless mismanaged. (3 November 2006)

In the medical corridor in the Hammersmith Hospital between 1947 and 1951, I recall that there were three labs on the left hand side and Sir John McMichael’s office was on the right hand side...we had the artificial kidney in the second lab. Eventually we got a building (shed) at the back of the Hammersmith for our kidney work. (12 November 2006)

Dialysis for acute renal failure was a long day’s procedure. The machine was set working using blood from the blood bank. It was important that the coils of cellophane tubing on the rotating cylinder did not leak into the fluid in the bath. Joekes was the expert on rotation couplings, which he sealed with what looked like sterilized Vaseline (I always watched with suspicion). Blood from the patient (a pint at a time) was fed by gravity from a stand, passed through the rotation coupling to the rotating drum, collected through the coupling at the other end and returned to the patient. I suppose we used both arms and cannulae in the veins. This was done for a good long time and seemed to involve a good many pints. Blood and bath fluid were monitored by the biochemistry

¹⁸² Bull *et al.* (1950).

lab. The patient had been heparinized and needed careful clinical watching. A patient with abdominal lesions might bleed (on occasion fatally). Infection was always a hazard. I can't remember the temperature of the bath fluid. On one occasion the cellophane coil ruptured – the machine was switched off – the ends of the coil at the site of the rupture were clamped and an anastomosis made and we carried on.

The three of us kept going with black coffee. It was a time of meat shortage and Bull got a regular supply of biltong, which he produced on these occasions. It was very salty. At the end of the day I might feel rather nauseated. Bull and Joeke came in early to start the procedure, I drove round the north circular road from Essex, arriving about 9 am. Bull and Joeke left in the early evening and I stayed overnight so that I could 'clean up', check that biochemical monitoring was complete and look after the patient. I could get a spare room and bed if need be. I remember one fatality at least (from fatal bleeding from an abdominal lesion). (12 November 2006)

Professor John McMichael (later Sir John) was pleased that the Kolff kidney was being used experimentally in the Hammersmith Hospital and gave a talk about it on BBC radio during the time I was there... The Kolff artificial kidney was still in use and I participated in its use in some desperately ill cases... It was about this time that Bull and Joeke were expressing doubts about the clinical usefulness of this prototype artificial kidney and considering the dangers of dialysis. The mystique and glamour of the artificial kidney and the fact that as distinguished a physician as Eric Bywaters had used it was the reason for cases of acute anuria to be referred to us from London undergraduate teaching hospitals and from regions outside of London. These peacetime cases were very different from wartime traumatic cases of anuria. The main groups that we identified were:

1. concealed accidental haemorrhage of pregnancy
2. criminal abortions
3. poisonings and sulphonamide anuria
4. mismatched blood transfusions and other 'haemorrhagic nephroses' (as they were called).

We were able to identify common causes of mismanagement such as:

1. forced fluids and other causes of fluid and electrolyte imbalance
2. administration of potassium citrate
3. decapsulation of the kidney and other surgical procedures meant to initiate diuresis.

In those cases that came to us early, we described the period of anuria, the early diuretic phase and the late diuretic phase. They could merge into each other, but each had its dangers and different management.

This was a finite piece of research that kept us busy from 1948 to about 1950. We then had to determine our future careers and research interests. We did not discredit the artificial kidney or even discard it. In the *Lancet* article we indicated conditions in which it might be used to supplement the Bull regime. The artificial kidney was left in the laboratory when we left.¹⁸³ (19 February 2007)

I had enjoyed my few years working on the kidney. I thought it important that we should document our early experience.¹⁸⁴ I doubt if our conservative regimen delayed development of the artificial kidney: it reduced the mortality in the anurias from c. 90 per cent to less than 50 per cent meantime. Improvement of the Kolff artificial kidney and the development of other models was going on steadily abroad and such machines could be imported. (24 December 2006)

¹⁸³ Dr John Turney wrote: 'Lowe became a cardiologist and professor of medicine at Dundee. Bull and Milne were clinical physiologists and professors of medicine at Belfast and Westminster respectively; Bywaters became a rheumatologist; only Joeekes remained within renal medicine.' Note on draft transcript, 26 February 2008.

¹⁸⁴ See, for example, Bull *et al.* (1957, 1958); Lowe (1952, 1953).

Appendix 2

From Sir Graham Bull (19 April 1979)¹⁸⁵

At one time Kampen, in the Netherlands, rivalled Amsterdam in overseas trade but lost its importance as the river silted up. Before the war it became the administrative centre for the Noord Ost Polder, the area of reclaimed land in the north east of the Zuider Zee. A government laboratory for soil analysis was placed there and, during the war and the period when Kolff was developing the artificial kidney, was in charge of a man named W R (Rudd) Domingo, whom I believe was Javanese. It was, of course, important for the reclamation work to have regular determinations of electrolytes such as Na, K, Cl etc. and the laboratory used flame photometers for some of the determinations. It seems clear to me that Domingo must have played a very large part in making the artificial kidney a practical proposition by carrying out analyses for Kolff.¹⁸⁶

Very soon after the war, Kolff contacted Eric Bywaters who had defined the crush syndrome during the Blitz and offered him an artificial kidney. This reached the Hammersmith Hospital in the latter part of 1946, but, very soon afterwards, Bywaters was offered and accepted the post of director of the MRC rheumatology unit at Taplow. In February 1947 Bull came to the Hammersmith and joined the Bywaters team, which included A M Joeques and Kenneth Lowe. Bywaters left the Hammersmith soon afterwards and Bull was appointed lecturer with charge of the beds. Bull remained there until 1952 when he moved to the chair of medicine in Belfast.

During much of this period of about five years, the Hammersmith artificial kidney was the only one working in Britain and, as far as we knew, initially in the world. Kolff in America had the problem of setting up a new department and did not, as far as I know, treat patients for some year or three. The result was that Bull, Joeques and Lowe were asked to see many patients with acute renal failure and other forms of kidney disease. Most of these were in London and due to mismatched blood transfusions, abortions, concealed accidental haemorrhage and drug-induced causes.¹⁸⁷

¹⁸⁵ Excerpt from a letter addressed to 'David', given by Sir Graham's daughter to Professor Kenneth Lowe, original recipient unknown.

¹⁸⁶ Dr John Turney wrote: 'Cameron also emphasizes this opinion, see Cameron (2002): 116.' Note on draft transcript, 13 July 2009.

¹⁸⁷ See Appendix 1, page 82.

There was at the time very poor recognition of the importance of maintenance of water and electrolyte balance and many of the patients they were asked to see were in trouble on this account. Water and salt overload was very frequent indeed. We were feeling our way on the proper use of the artificial kidney – trying to define the most appropriate time to use it and simultaneously trying to determine the pathophysiology of the kidney failure and cause of death. Apart from salt and water overload, infection was important and contributed to causing death in quite a number of patients. We tried to keep the blood urea low, in the belief that end products of nitrogen metabolism were important, and used the artificial kidney sooner rather than later. However, as we appreciated the role of water and electrolyte disturbances and the possibilities of keeping the catabolic rate down by avoiding infection and the use of a protein free, ‘protein sparing’ diet, as had been suggested by Borst, we delayed the use of the artificial kidney more and more. The first artificial kidney was not without its troubles. Every patient developed rigors about 20–30 minutes after starting and the open bath, which was kept at 37°C, was an ideal medium for the growth of organisms. Pinholes in the cellophane sausage casing used for dialysis also caused trouble.¹⁸⁸

Another person who influenced the development of the conservative regimen was Francis Avery Jones who had realized early on the importance of fluid overload in causing death. Thus the conservative regimen was effectively a combination of Borst and Avery Jones.

It would not have been possible to use the artificial kidney or develop an effective conservative regimen without the free availability of electrolyte determinations at the Hammersmith and here Domingo comes into the picture again. Earl J King, the head of biochemistry and Klyne, senior lecturer, learnt of Domingo’s use of flame photometry on patients under Kolff and invited him to spend some time at the Hammersmith. Domingo and King then set up the flame photometer as a biochemical service instrument.

¹⁸⁸ See page 22.

References

- Adu D, Emery P, Madaio M P. (eds) (2001) *Rheumatology and the Kidney*. Oxford: Oxford University Press.
- Alexander S. (1962) They decide who lives, who dies: medical miracle and a moral burden of a small committee. *Life* **53**: 102–25.
- Alwall N. (1963) *Therapeutic and Diagnostic Problems in Severe Chronic Renal Failure*. Munksgard: Copenhagen.
- Anderson J, Neary F, Pickstone J, Raftery J. (2007) *Surgeons, Manufacturers and Patients: A transatlantic history of total hip replacement*. Basingstoke, NY: Palgrave Macmillan.
- Andrus F C. (1929) Use of Visking sausage casing for ultrafiltration. *Proceedings of the Society for Experimental Biology and Medicine* **27**: 127–8.
- Anon. (1965) Editorial: profit and loss in intermittent haemodialysis. *Lancet* **ii**: 1058–9.
- Anon. (1973) Editorial: medicarelessness. *New York Times* (14 January): 234.
- Anon. (1974) Ghana Institute of Clinical Genetics. *British Medical Journal* **ii**: 513.
- Anon. (1993) Moving points in nephrology. Festschrift in honor of Geoffrey M Berlyne on the occasion of his 60th birthday. *Contributions to Nephrology* **102**: 1–254.
- Assenat H, Calemard E, Charra B, Laurent G, Terrat J C, Vanel T. (1980) Hemodialyze, syndrome du canal carpien et substance amyloïde. *Nouvelle Presse Médicale* **9**: 1715.
- Babb A L. (1995) Design and construction of a portable, single patient, dialysate proportioning machine at the University of Washington 1964/5. *Journal of the American Society for Artificial Internal Organs* **41**: 1–10.
- Baillod R A, Moorhead J F. (1974) Review of ten years' home dialysis. *Proceedings of the European Dialysis and Transplant Association* **11**: 68–76 www.era-edta.org/proceedings/vol11/vol11%20068_076.pdf (visited 23 November 2009).

- Baillod R A, Varghese Z, Fernando O N, Moorhead J F. (1980) Review of 71 patients receiving renal replacement for greater than ten years. In Giordano C, Friedman E A. (eds) (1981) *Uremia: Pathobiology of patients treated for ten years or more*. Milan: Wichtig.
- Baillod R A, Crockett R E, Lee B N, Moorhead J F, Stevenson C M. (1967) Establishment of a home dialysis day training centre with continuation of improved nocturnal hospital dialysis. *Proceedings of the European Dialysis and Transplant Association* **4**: 30–4 www.era-edta.org/proceedings/vol4/V4_006.pdf (visited 18 May 2009).
- Baillod R A, Comty C M, Ilahi M, Konotey-Ahulu F I D, Sevitt L, Shaldon S. (1965) Overnight haemodialysis in the home. *Proceedings of the European Dialysis and Transplant Association* **2**: 99–103.
- Bardin T, Zingraff J, Kuntz D, Drüeke T. (1986) Dialysis-related amyloidosis. *Nephrology Dialysis Transplantation* **1**: 151–4.
- Barker C F. (2005) Biographical memoirs: Jonathan E Rhoads. *Proceedings of the American Philosophical Society* **149**: 431–40.
- Black D A. (1965) Letter to the editor: profit and loss in intermittent haemodialysis. *Lancet* **ii**: 1247.
- Black D A, Milne M D. (1952) Experimental potassium depletion in man. *Lancet* **i**: 244–5.
- Blackmore D J, Elder W J. (1961) The artificial kidney and urea clearance. *Journal of Clinical Pathology* **14**: 455–62.
- Blagg C R. (2000) What went wrong with home haemodialysis in the US and what can be done? *Haemodialysis International* **4**: 55–8.
- Blagg C R. (2005) Home haemodialysis: ‘home, home, sweet, sweet home!’ *Nephrology* **10**: 206–14.
- Blagg C R. (2006) Belding Hibbard Scribner, the individual: a brief biography. *Journal of Nephrology* **19** (Suppl.): 127–31.
- Blagg C R. (2007) The early history of dialysis for chronic renal failure in the US: a view from Seattle. *American Journal of Kidney Diseases* **49**: 482–96.
- Blagg C R. (2008) Editorial: home haemodialysis. *British Medical Journal* **336**: 3–4.

- Blagg C R, Parsons F M. (1965) Letter: profit and loss in intermittent haemodialysis. *Lancet* **ii**: 1246.
- Blagg C R, Clark M, Pollard T L, Sawyer T K. (1972) A regional program for treatment of chronic renal failure. Abstract. *Fifth International Congress of Nephrology, Mexico City*: 15.
- Blagg C R, Eschbach J W, Sawyer T K, Casaretto A A. (1971) Dialysis for end-stage diabetic nephropathy. *Proceedings of the Clinical Dialysis and Transplantation Forum* **1**: 133–5.
- Blomfield J, McPherson J, George C R P. (1969) Active uptake of copper and zinc during haemodialysis. *British Medical Journal* **ii**: 141–5.
- Blomfield J, Dixon S R, McCredie D A. (1971) Potential hepatotoxicity of copper in recurrent haemodialysis. *Archives of Internal Medicine* **128**: 555–60.
- Blumberg B S, Sutnick A I, London W T. (1968) Hepatitis and leukaemia: their relation to Australia antigen. *Bulletin of the New York Academy of Medicine* **44**: 1566–86.
- Bone J M, Tonkin R W, Davison A M, Marmion B P, Robson J S. (1971) Outbreak of dialysis-associated hepatitis in Edinburgh, 1969–70. *Proceedings of the European Dialysis and Transplant Association* **8**: 189–97.
- Booth C C. (1993) Clinical research. In Bynum W F, Porter R. (eds) *Companion Encyclopaedia of the History of Medicine*, vol 1. London: Routledge: 205–29.
- Borst J G G. (1948) Protein catabolism in uraemia. Effects of protein-free diet, infections and blood transfusions. *Lancet* **i**: 824–9.
- Broers H. (2007) *Inventor for Life: The Story of W J Kolff, Father of Artificial Organs*. Kampen: B & V Media.
- Bull G M, Carter A B, Lowe K G. (1953) Hyperpotassaemic paralysis. *Lancet* **262**: 60–3.
- Bull G M, Joekes A M, Lowe K G. (1949) Conservative treatment of anuric uraemia. *Lancet* **254**: 229–34.
- Bull G M, Joekes A M, Lowe K G. (1950) Renal function studies in acute tubular necrosis. *Clinical Science* **9**: 379–404.
- Bull G M, Joekes A M, Lowe K G. (1955) Acute renal failure associated with concealed accidental haemorrhage of pregnancy. *Lancet* **266**: 1152–6.

- Bull G M, Joekes A M, Lowe K G. (1956) Acute tubular necrosis of the kidney following abortion. *Lancet* **267**: 186–9.
- Bull G M, Joekes A M, Lowe K G. (1957) Acute renal failure following intravascular haemolysis. *Lancet* **270**: 114–17.
- Bull G M, Joekes A M, Lowe K G. (1958) Acute renal failure due to poisons and drugs. *Lancet* **271**: 134–7.
- Bynum W F, Lawrence C, Nutton V (eds). (1985) The emergence of modern cardiology. *Medical History* (Suppl.) **5**: 1–178.
- Bywaters E G. (1990) Fifty years on: the crush syndrome. *British Medical Journal* **301**: 1412–15.
- Bywaters E G, Beall D. (1941) Crush injuries with impairment of renal function. *British Medical Journal* **i**: 427–32.
- Bywaters E G, Joekes A M. (1948) The artificial kidney: its clinical application in the treatment of traumatic anuria. *Proceedings of the Royal Society of Medicine* **41**: 420–6.
- Cameron J S. (1997) Arthur Arnold Osman (1893–1972): a forgotten pioneer of nephrology. *Nephrology Dialysis Transplantation* **12**: 1526–30.
- Cameron J S. (2000a) *The First Half-Century of the Renal Association, 1950–2000*. London: King's College www.renal.org/pages/media/download_gallery/RAhistoryA.pdf (visited 5 March 2009).
- Cameron J S. (2000b) Practical haemodialysis began with cellophane and heparin: the crucial role of William Thalheimer (1884–1961). *Nephrology Dialysis Transplantation* **15**: 1086–91.
- Cameron J S. (2002) *History of the Treatment of Renal Failure by Dialysis*. Oxford: Oxford University Press.
- Cameron J S. (2006) The discovery of diabetic nephropathy from small print to centre stage. *Journal of Nephrology* **19** (Suppl.): 575–87.
- Cameron J S. (2007) Nephrologist extraordinary: Michael Darmady (1906–89). *Nephrology Dialysis Transplantation* **22**: 715–21.
- Chisholm G D. (1961) The Scribner arteriovenous fistula for haemodialysis. *British Medical Journal* **ii**: 30–3.

- Christie D A, Tansey E M. (eds) (2001) *Origins of neonatal intensive care*. Wellcome Witnesses to Twentieth Century Medicine, vol. 9. London: The Wellcome Trust Centre for the History of Medicine at UCL. Also at www.ucl.ac.uk/histmed/publications/wellcome_witnesses_c20th_med.html or by following the links to Publications/Wellcome Witnesses from www.ucl.ac.uk/histmed.
- Clark P B, Parsons F M. (1966) Routine use of the Scribner shunt for haemodialysis. *British Medical Journal* **i**: 1200–2.
- Cole J J, Pollard T L, Murray J S. (1963) Studies on the modified polypropylene Kiil dialyzer. *Transactions of the American Society for Artificial Internal Organs* **9**: 67–72.
- Colliss J E, Levi A J, Milne M D. (1963) Stature and nutrition in cystinuria and Hartnup disease. *British Medical Journal* **i**: 590–2.
- Cook N R, Cutler J A, Obarzanek E, Buring J E, Rexrode K M, Kumanyika S K, Appel L J, Whelton P K. (2007) Long-term effects of dietary sodium reduction on cardiovascular disease outcomes: observational follow-up of the trials of hypertension prevention. *British Medical Journal* **334**: 885–8.
- Cooter R, Pickstone J V. (eds) (2002) *Companion to Medicine in the Twentieth Century*. London: Routledge.
- Cossart Y E. (1971) Australia antigen and hepatitis: a review. *Journal of Clinical Pathology* **24**: 394–403.
- Darrah J B. (1987) The committee. *Transactions of the American Society for Artificial Internal Organs* **33**: 791–3.
- Dathan J R E, Frankel R J, Goodwin F J, Marsh F P, Murray M, Thompson J M A, Youngs G. (1970) One year's experience in a Ministry of Health dialysis centre. *British Medical Journal* **ii**: 102–5.
- Dempster W J. (1953) Kidney homotransplantation. *British Journal of Surgery* **40**: 447–65.
- Dempster W J. (1956) Homotransplantation of organs. *Lectures on the Scientific Basis of Medicine* **6**: 13–27.
- Department of Health and Social Security. (1972) *Report of the Advisory Group 1970–72: Hepatitis and the treatment of chronic renal failure*. London: HMSO.

- Diamond L K. (1980) The story of our blood groups. In Wintrobe M M. (ed.) *Blood Pure and Eloquent: A story of discovery, of people, and of ideas*. New York, NY: McGraw Hill: 691–718.
- Dixon A. (2003) Obituary: Eric Bywaters, 1910–2003. *Rheumatology* **42**: 1025–7.
- Doll R, Hill A B. (1954) The mortality of doctors in relation to their smoking habits; a preliminary report. *British Medical Journal* **i**: 1451–5.
- Domingo W R, Klyne W. (1949) A photoelectric flame photometer. *Biochemical Journal* **45**: 400–8.
- Douglas C. (1975) *The Houseman's Tale*. Edinburgh: Canongate.
- Douglas J F. (1998) Laudatio for Professor Mary G McGeown. *Nephrology Dialysis Transplantation* **13**: 1380–3.
- Drukker W. (1989) Haemodialysis: a historical review. In Maher J F. (ed.) *Replacement of Renal Function by Dialysis*, 3rd edn. Dordrecht: Kluwer: 19–86.
- Eady R A J. (1965) Letter: profit and loss in intermittent haemodialysis. *Lancet* **ii**: 1246.
- Eady R A J. (2001) The dawn of dialysis: reminiscences of a patient. *British Journal of Renal Medicine* **6**: 21–4.
- Eady R A J. (2008) Survival is not enough: reflections of a long-term renal patient. *Journal of Nephrology* **21** (Suppl. 13): S3–S6.
- Elga Group. (1969) *Water Requirements for Kidney Dialysis: Report of a one-day conference held at the Kensington Palace Hotel, London, 28 May 1969*. Lane End, Bucks: Elga Publication.
- Epstein F H. (2001) John P Peters and nephrology. *American Journal of Kidney Diseases* **37**: 1113–19.
- Eschbach J W Jr, Wilson W E Jr, Peoples R W, Wakefield A W, Babb A L, Scribner B H. (1966) Unattended overnight home haemodialysis. *Transactions of the American Society for Artificial Organs* **12**: 346–56.
- European Renal Association (2006) *European Registry Report*. www.era-edta-reg.org/index.jsp?p=annrep (visited 4 November 2009).

- Evans D B, Curtis J R, de Wardener H E. (1965) Letter: profit and loss in intermittent haemodialysis. *Lancet* **ii**: 1245.
- Evans D B, de Wardener H E, Curtis J R, Storey J M, Jennings P J. (1965) Prototype maintenance haemodialysis unit. *Lancet* **i**: 1012–13.
- Fine J, Frank H A, Seligman A M. (1946) The treatment of acute renal failure by peritoneal irrigation. *Annals of Surgery* **124**: 857–78.
- Fox R A, Knight A H, Niazi S P, Sherlock S, Baillod R A, Moorhead J F. (1971) An epidemic of hepatitis in a renal dialysis unit. *Proceedings of the Royal Society of Medicine* **64**: 277–8.
- Gambro. (2006) *A Tour Through Gambro's History of Haemodialysis*. Sweden: Elanders Berlings.
- Goldsmith H J, Cowan M A, Gooder E. (1958) Familial outbreak of acute glomerulonephritis due to Griffith type-1 streptococcus. *Lancet* **ii**: 674–5.
- Goodall J B. (1971) Water for renal dialysis. In Whelpton D. (ed.) (1974) *Renal Dialysis*. London: Sector Publishing: 123–34.
- Gordon P. (1974) Home dialysis and the cost of living. In Whelpton D. (ed.) *Renal Dialysis*. London: Sector Publishing: 33–8.
- Grant K M, Whelpton D. (1974) Running a regional home dialysis service. In Whelpton D. (ed.) *Renal Dialysis*. London: Sector publishing: 19–28.
- Grollman A. (1951) *Acute Renal Failure*. Springfield, IL: Charles C Thomas.
- Grollman A, Turner L B, MacLean J A. (1951) Intermittent peritoneal lavage in nephrectomised dogs and its application to the human being. *Archives of Internal Medicine* **87**: 379–90.
- Hall M, Kerr D N S, Smart G, Ashcroft R, Elliot W, Swinney J. (1961) The Alwall artificial kidney, an assessment after one year. *British Journal of Urology* **32**: 2–16.
- Hamilton D H. (1984) Developing the artificial kidney in Britain: Frank Maudsley Parsons at Leeds. *University of Leeds Review* **27**: 89–96.
- Hardy A, Tansey E M. (2006) Medical enterprise and global response, 1945–2000. In Bynum W F, Hardy A, Jacyna S, Lawrence C, Tansey E M. *The Western Medical Tradition 1800–2000*. Cambridge: Cambridge University Press: 405–534.

- Haviland J W. (1965) Experiences in establishing a community artificial center. *Transactions of the American Clinical and Climatological Association* **77**: 125–9.
- Hawe B J, Goldsmith H J, Jones P O. (1971) Dialysis-associated hepatitis: prevention and control. *British Medical Journal* **i**: 540–3.
- Hegstrom R M, Quinton W E, Dillard D, Cole J J, Scribner B H. (1961) One year's experience with the use of indwelling Teflon cannulas and bypass. *Transactions of the American Society for Artificial Internal Organs* **7**: 47–59.
- Hennessy P. (1994) *Never Again: The UK 1945–1951*. New York, NY: Pantheon.
- Hoenich N A, Strong A, Strong H, Frost T, Kerr D N S. (1970) Performance studies *in vivo* and *in vitro* in batches of consecutively manufactured Kiil dialyzers. *Proceedings of the European Dialysis and Transplant Association* **7**: 484–5.
- Ivanovich P, Manzler A D, Drake R. (1969) Acute haemolysis following haemodialysis. *Transactions of the American Society for Artificial Internal Organs* **15**: 316–18.
- Iversen P, Brun C. (1951) Aspiration biopsy of the kidney. *American Journal of Medicine* **11**: 324–30.
- Jackson R C. (1958) Experiences with the Kolff twin-coil artificial kidney at the renal unit, Princess Mary's Royal Air Force Hospital, Halton. *Proceedings of the Royal Society of Medicine* **51**: 1071–2.
- Jackson R C, Bunker N V, Elder W J, Joekes A M. (1960) Treatment of renal failure in a unit with facilities for haemodialysis (twin-coil artificial kidney). Results with 80 patients. *British Medical Journal* **ii**: 1909–16.
- Jonsen A R. (1998) *The Birth of Bioethics*. New York, NY; Oxford: Oxford University Press: 212–13.
- Kark R M, Muehrcke R C. (1954) Biopsy of kidney in prone position. *Lancet* **266**: 1047–9.
- Kennedy A C, Gray M J, Dinwoodie A, Linton A L. (1961) Removal of urea, creatinine, uric acid and inorganic phosphate by a rotating-drum artificial kidney. *Lancet* **ii**: 996–8.

- Kerr D N S, Elliott W, Swinney J. (1965) Letter: profit and loss in intermittent haemodialysis. *Lancet* **ii**: 1245–6.
- Kerr D N S, Ward M K, Arze R S, Ramos J M, Grekas D, Parkinson I S, Ellis H A, Owen J P, Simpson W, Dewar J, Martin A M, McHugh M F. (1986) Aluminum-induced dialysis osteodystrophy: the demise of ‘Newcastle bone disease’? *Kidney International* **29** (Suppl.): 58–64.
- Kiil F. (1960) Development of parallel-flow artificial kidney. *Acta Chirurgia Scandinavica* **253** (Suppl.): 142–50.
- Kiil F. (1969) Artificial kidneys and renal transplantation. *Scandinavian Journal of Clinical and Laboratory Investigation* **23**: 281–3.
- Knight A H, Fox R A, Baillod R A, Niazi S P, Sherlock S, Moorhead J F. (1970) Hepatitis-associated antigen and antibody in haemodialysis patients and staff. *British Medical Journal* **iii**: 603–6.
- Kolff W J, Watschinger B. (1956) Further development of a coil kidney: disposable artificial kidney. *Journal of Laboratory and Clinical Medicine* **47**: 969–77.
- Konotey-Ahulu F I D. (2008) Home haemodialysis: just the thing for Africa’s wealthy patients. *British Medical Journal: Rapid Response to Blagg*. (2008) Online at www.bmj.com/cgi/eletters/336/7634/3#186073 (visited 21 November 2008).
- Konotey-Ahulu F I D, Anderson G. (1965) Treatment of hyperkalaemic cardiac arrest by timely haemodialysis. *Ghana Medical Journal* **4**: 158–63.
- Konotey-Ahulu F I D, Baillod R A, Comty C M, Heron J R, Shaldon S, Thomas P K. (1965) Effect of periodic dialysis on the peripheral neuropathy of end-stage renal failure. *British Medical Journal* **ii**: 1212–15.
- Lenzer J. (2003) Belding Scribner: the inventor of shunt dialysis. *British Medical Journal* **327**: 167.
- Lindner A, Charra B, Sherrard D J, Scribner B H. (1974) Accelerated atherosclerosis in prolonged maintenance hemodialysis. *New England Medical Journal* **290**: 697–701.
- Lowe K G. (1952) The late prognosis in acute tubular necrosis. *Lancet* **259**: 1086–8.

- Lowe K G. (1953) Metabolic studies with potassium-free electrolyte-free diet in man. *Clinical Science* **12**: 57–62.
- Lowe K G, Valtin H. (1956) Dietary treatment in acute anuria. *American Journal of Clinical Nutrition* **4**: 486–96.
- Lowrie E G, Lazarus J M, Hampers C L, Merrill J P. (1974) Editorial: cardiovascular disease in dialysis patients. *New England Journal of Medicine* **290**: 737–8.
- Lyle W H. (1967) Chronic dialysis and copper poisoning. *New England Journal of Medicine* **276**: 1209–10.
- Lyle W H. (1969) Letter: testing dialysis fluids. *British Medical Journal* **ii**: 300.
- Lyle W H, Payton J E, Hui M. (1976) Haemodialysis and copper fever. *Lancet* **i**: 1324.
- Maher J F. (ed.) (1989) *Replacement of Renal Function by Dialysis*, 3rd edn. Dordrecht: Kluwer.
- Maher J F, Schreiner G E, Waters T J. (1960) Successful intermittent haemodialysis: longest reported maintenance of life in true oliguria (181 days). *Transactions of the American Society for Artificial Internal Organs* **6**: 123–42.
- Manzler A D, Drake R. (1969) Acute haemolysis following haemodialysis. *Transactions of the American Society for Artificial Internal Organs* **15**: 316–18.
- Manzler A D, Schreiner A W. (1970) Copper-induced acute haemolytic anemia: a new complication of haemodialysis. *Annals of Internal Medicine* **73**: 409–12.
- Maupas P, Goudeau A, Coursaget P, Drucker J, Bagros P. (1976) Immunisation against hepatitis B in man. *Lancet* **i**: 1367–70.
- McBride P T. (1979) *Genesis of the Artificial Kidney*. Deerfield, IL: Travenol Laboratories.
- McCance R A, Widdowson E M. (1939) *The Chemical Composition of Foods*. Special report series (Medical Research Council of Great Britain) vol. 235. London: HMSO.

- McKellar S. (1999) Gordon Murray and the artificial kidney in Canada. *Nephrology Dialysis Transplantation* **14**: 2766–70.
- McKellar S. (2003) *Surgical Limits: The life of Gordon Murray*. Toronto: University of Toronto Press.
- Melrose D G (1953) Mechanical heart–lung for use in man. *British Medical Journal* **ii**: 57–62.
- Merrill J P. (1952) The use of the artificial kidney in the treatment of uremia. *Bulletin of the New York Academy of Medicine* **28**: 523–31.
- Merrill J P, Smith S III, Callahan E J III, Thorn G W. (1950) The use of an artificial kidney II: clinical experience. *Journal of Clinical Investigation* **29**: 425–38.
- Milne M D. (1967) Cystinuria, 1810–1965. *Scientific Basis of Medicine Annual Reviews*: 227–51.
- Milne M D. (1969) Hartnup disease. *Biochemical Journal* **111**: 3–4.
- Milne M D, Scribner B H, Crawford M A. (1958) Non-ionic diffusion and the excretion of weak acids and bases. *American Journal of Medicine* **24**: 709–29.
- Milne M D, Scribner B H, Crawford M A. (1981) Citation classic: Non-ionic diffusion and the excretion of weak acids and bases. *Current Contents: Life Sciences* **7**: 244, also at <http://garfield.library.upenn.edu/classics1981/A1981LA47900002.pdf> (visited 14 May 2009).
- Ministry of Health. (1965) *Conference on Intermittent Dialysis for Chronic Renal Failure. Mimeographed minutes*. London: HMSO.
- Ministry of Health. (1966) *Conference on Intermittent Dialysis for Chronic Renal Failure. Mimeographed minutes*. London: HMSO.
- Muirhead E E, Vanatta J, Grollman A. (1949) Acute renal insufficiency: a comparison of the use of an artificial kidney, peritoneal lavage and more conservative measures in its management. *Archives of Internal Medicine* **83**: 528–31.
- Nakamoto S, Brandon J M, Franklin M, Rosenbaum J, Kolff W J. (1961) Experience with AV shunt cannulas for repeated dialyses. *Transactions of the American Society for Artificial Internal Organs* **7**: 57–9.

- National Institute for Health and Clinical Excellence (NICE). (2002) *Renal Failure: Home versus hospital haemodialysis: Guidance on home compared to hospital haemodialysis for patients with end-stage renal failure*. London: NICE www.nice.org.uk/TA048#documents (visited 3 April 2009).
- National Kidney Disease Foundation. (1963) *Proceedings of Conference to Consider the Treatment of Patients with Chronic Kidney Disease with Uraemia*. New York, NY: American Medical Association and National Kidney Foundation.
- Ness A R, Reynolds L A, Tansey E M (eds). (2002) *Population-based Research in South Wales: The MRC Pneumoconiosis Research Unit and the MRC Epidemiology unit*. Wellcome Witnesses to Twentieth Century Medicine, vol. 13. London: The Wellcome Trust Centre for the History of Medicine at UCL. Also at www.ucl.ac.uk/histmed/publications/wellcome_witnesses_c20th_med or by following the links to Publications/Wellcome Witnesses from www.ucl.ac.uk/histmed.
- Nissenson A R, Rettig R A. (1999) Medicare's end-stage renal disease program: current status and future prospects. *Health Affairs* **18**: 161–79.
- Ogg C S, Bewick M, Cameron J S, Ellis F G. (1972) Hepatitis at Guy's hospital. *Proceedings of the European Dialysis and Transplant Association* **9**: 228–34.
- Parkinson I S, Ward M K, Kerr D N S. (1981) Dialysis encephalopathy, bone disease and anaemia: the aluminium intoxication syndrome during regular haemodialysis. *Journal of Clinical Pathology* **34**: 1285–94.
- Parsons F M. (1989) Origins of haemodialysis in the UK. *British Medical Journal* **299**: 1557–60.
- Parsons F M, McCracken B H. (1957) The artificial kidney. *British Journal of Urology* **29**: 424–33.
- Parsons F M, McCracken B H. (1959) The artificial kidney. *British Medical Journal* **i**: 740–51.
- Parsons F M, Brunner F P, Burck H C, Gräser W, Gurland H J, Härlen H, Schärer K, Spies G W. (1974) *Proceedings of the European Dialysis and Transplant Association* **11**: 3–67. Also at www.era-edta.org/proceedings/vol11/vol11%20001_067.pdf (visited 4 November 2009).

- Peart S. (1995) Malcolm Davenport Milne. *Biographical Memoirs of the Fellows of the Royal Society* **41**: 297–307.
- Peitzman S J. (2007) *Dropsie, Dialysis, Transplant: A short history of failing kidneys*. Baltimore, MD: Johns Hopkins University Press.
- Pendras J P, Smith M P. (1966) The silastic-Teflon arteriovenous cannula. *Transactions of the American Society for Artificial Internal Organs* **12**: 222–6.
- Platts M M. (1980) Dialysis encephalopathy. *Lancet* **ii**: 1035–6.
- Platts M M, Anastassiades E. (1981) Dialysis encephalopathy: precipitating factors and improvement in prognosis. *Clinical Nephrology* **15**: 223–8.
- Platts M M, Moorhead P J, Grech P. (1973) Dialysis dementia. *Lancet* **ii**: 159.
- Quinton W E, Dillard D H, Scribner B H. (1960) Cannulation of blood vessels for prolonged haemodialysis. *Transactions of the American Society for Artificial Internal Organs* **6**: 104–13.
- Quinton W E, Dillard D H, Cole J J, Scribner B H. (1961) Possible improvements in the technique of long-term cannulation of blood vessels. *Transactions of the American Society for Artificial Internal Organs* **7**: 60–3.
- Rae A I, Rosen S M, Silva H, Pomeroy J, Bienenstock J, Shaldon S. (1963) Rehabilitation of terminal uraemic patients by periodic haemodialysis. *Proceedings of the Royal Society of Medicine* **56**: 760–1.
- Reynolds L A, Tansey E M. (eds) (2006) *Early Development of Total Hip Replacement*. Wellcome Witnesses to Twentieth Century Medicine, vol. 29. London: The Wellcome Trust Centre for the History of Medicine at UCL. Also at www.ucl.ac.uk/histmed/publications/wellcome_witnesses_c20th_med or by following the links to Publications/Wellcome Witnesses from www.ucl.ac.uk/histmed.
- Reynolds L A, Tansey E M. (eds) (2007) *Medical Ethics Education in Britain, 1963–1993*. Wellcome Witnesses to Twentieth Century Medicine, vol. 31. London: The Wellcome Trust Centre for the History of Medicine at UCL. Also at www.ucl.ac.uk/histmed/publications/wellcome_witnesses_c20th_med or by following the links to Publications/Wellcome Witnesses from www.ucl.ac.uk/histmed.
- Richet G. (1999) Les débuts de la dialyse à l'assistance publique de Paris. *La Semaine des Hôpitaux de Paris* **75**: 162–4.

- Richet G, Muller A. (2001) The First International Congress of Nephrology, Genève–Evian, 1–3 September 1960. *Néphrologie* **22**: 175–7.
- Robinson H. (1974) Evaluation of haemodialysis machines. In Whelpton D. (ed.) *Renal Dialysis*. London: Sector Publishing: 39–52.
- Robinson R R, Richet G. (2001) International Society of Nephrology: a forty-year history, 1960–2000. *Kidney International* (Suppl.) **79**: 1–100.
- Robson J S, Dudley H A F. (1958) *Report on the UK Artificial Kidney Units*. Edinburgh: Royal Infirmary. See www.EdRen.org (visited 5 March 2009).
- Roderick P, Willis N S, Blakeley S, Jones C, Tomson C. (2007) Correction of chronic metabolic acidosis for chronic kidney disease patients. *Cochrane Database of Systematic Reviews Online* **1**: CD001890 www.mrw.interscience.wiley.com/cochrane/clsystrev/articles/CD001890/frame.html (visited 20 May 2009).
- Ross J C. (1953) Renal tuberculosis. *British Journal of Urology* **25**: 277–315.
- Sanders D, Dukeminier J. (1968) Medical advance and legal lag: Hemodialysis and kidney transplantation. *UCLA Law Review* **15**: 357–413.
- Scribner B H. (1950) Bedside determination of chloride: a method for plasma, urine and other fluids and its application to fluid balance problems. *Proceedings of the Staff Meetings. Mayo Clinic* **25**: 209–18.
- Scribner B H. (1964) Presidential address: ethical problems of using artificial organs to sustain human life. *Transactions of the American Society for Artificial Internal Organs* **10**: 209–12.
- Scribner B H, Caner J E, Buri R, Quinton W. (1960) The technique of continuous haemodialysis. *Transactions of the American Society for Artificial Internal Organs* **6**: 88–103.
- Seldinger S I. (1953) Catheter replacement of the needle in percutaneous arteriography: a new technique. *Acta Radiologica* **39**: 368–76.
- Shackman R, Milne M D. (1957) The use of the artificial kidney. *British Journal of Urology* **29**: 434–9.
- Shaldon S. (1964) Panel contribution on experience with overnight haemodialysis in the home. *Proceedings, Working Conference on Chronic Dialysis at University of Washington*. Seattle, WA: University of Washington Press: 40–1.

- Shaldon S. (1968) Independence in maintenance haemodialysis. *Lancet* **291**: 520–3.
- Shaldon S. (2004) Early history of home haemodialysis in the Federal Republic of Germany. *Journal of the American Society for Artificial Internal Organs* **50**: 291–3.
- Shaldon S. (2006) Alwall's often forgotten contribution to haemodialysis. *Seminars in Dialysis* **19**: 260.
- Shaldon S. (2009) First use of nocturnal dialysis. *Kidney International* **76**: 230.
- Shaldon S, Higgs B, Chiandussi L, Walker G, Garsenstein M, Ryder J. (1962) Measurement of renal blood flow in man with the use of indocyanine green infused into the renal artery. *Journal of Laboratory and Clinical Medicine* **60**: 954–66.
- Sheehan H L, Davis J C. (1958) Complete permanent renal ischaemia. *Journal of Pathology and Bacteriology* **76**: 569–87.
- Skeggs L T, Leonards J R. (1948) Studies on an artificial kidney: I: preliminary results with a new type of continuous dialyzer. *Science* **108**: 212–13.
- Smith C, Da Silva-Gane M, Chandna S, Warwicker P, Greenwood R, Farrington K. (2003) Choosing not to dialyze: evaluation of planned, non-dialytic management in a cohort of patients with end-stage renal failure. *Nephron, Clinical Practice* **95**: 40–6.
- Smith H W. (1951) *The Kidney, Structure and Function in Health and Disease*. New York, NY: Oxford University Press.
- Snow W, Clark M. (1976) Understanding patient learning and performance capabilities for home dialysis. *Journal of the American Association of Nephrology Nurses and Technicians* **3**: 20–4.
- Stanton J. (1999) The cost of living: kidney dialysis, rationing and health economics in the UK, 1965–96. *Social Science and Medicine* **49**: 1169–82.
- Tansey E M, Catterall P P. (eds) (1997) *Technology Transfer in Britain: The case of monoclonal antibodies*. Wellcome Witnesses to Twentieth Century Medicine, vol. 1: 1–34. London: The Wellcome Trust Centre for the History of Medicine at UCL. Also at www.ucl.ac.uk/histmed/publications/wellcome_witnesses_c20th_med or by following the links to Publications/Wellcome Witnesses from www.ucl.ac.uk/histmed.

- Tansey E M, Christie D A. (eds) (2000) *Looking at the Unborn: Historical aspects of obstetric ultrasound*. Wellcome Witnesses to Twentieth Century Medicine, vol. 5. London: The Wellcome Trust Centre for the History of Medicine at UCL. Also at www.ucl.ac.uk/histmed/publications/wellcome_witnesses_c20th_med or by following the links to Publications/Wellcome Witnesses from www.ucl.ac.uk/histmed.
- Tatler G L, Baillod R A, Varghese Z, Young W B, Farrow S, Wills M R, Moorhead J F. (1973) Evolution of bone disease over ten years in 135 patients with terminal renal failure. *British Medical Journal* **iv**: 315–19.
- Tosteson D C. (ed.) (1989) *Membrane Transport: People and ideas*. Baltimore, MD: Oxford University Press.
- Uldall R, Ouwendyk M, Francoeur R, Wallace L, Sit W, Vas S, Pierratos A. (1996) Slow nocturnal home haemodialysis at the Wellesley Hospital. *Advances in Renal Replacement Therapy* **3**: 133–6.
- Ward M K, Ellis H A, Feest T G, Parkinson I S, Kerr D N S, Herrington J, Goode G L. (1978) Osteomalacic dialysis osteodystrophy: evidence for a water-borne aetiological agent, probably aluminium. *Lancet* **311**: 841–5.
- Whelpton D. (ed.) (1974) *Renal Dialysis*. London: Sector Publishing.
- Williams R. (1978) Trials and tribulations with artificial liver support. *Gut* **19**: 578–83.
- Windschauer H. (1948) Artificial kidney at Guy's. *Guy's Hospital Gazette* **62**: 155–7.
- Wingate D. (1994) Obituary: Professor David Ritchie. *The Independent* (8 January).
- Wofffindin C, Hoenich N A. (1995) Haemodialyzer performance: a review of the trends over the past two decades. *Artificial Organs* **19**: 1113–19.
- Woodruff M F, Robson J S, Ross J A, Nolan B, Lambie A T. (1961) Transplantation of a kidney from an identical twin. *Lancet* **i**: 1245–9.

Biographical notes*

Dr Rosemarie Baillod

LRCP MRCS (b. 1936) qualified at the Royal Free Medical School in 1961 and worked in the renal unit there (1964–98). Under the direction of Dr Stanley Shaldon in 1964, she taught the first home haemodialysis patient in the UK and Europe. She was involved in safety, design and efficiency of dialysis equipment and access surgery, oversaw the expansion of home haemodialysis and initiated a children's home haemodialysis programme in 1969. She was also involved in the development of peritoneal dialysis in the home, setting up intermittent peritoneal dialysis in 1972 and later continuous ambulatory peritoneal dialysis in 1979. She has been emeritus consultant, Royal Free Hospital and emeritus honorary consultant, Great Ormond Street Hospital since 1998.

Professor Christopher Blagg

MD FRCP (b. 1931) qualified at the University of Leeds in 1954 receiving his MD in 1964. He was lecturer and senior lecturer in the department of medicine at the University of Leeds (1958–66),

working in the dialysis programme and received a US Public Health Service travelling fellowship to work with Dr Belding Scribner at the University of Washington, Seattle (1963/4). He moved to the University of Washington Medical School in 1966, and was professor of medicine there (1978–99), later emeritus. He was executive director of the Northwest Kidney Centers, Seattle (1971–98), president of the Renal Physicians Association (1975–77) and the Washington State Society of Internal Medicine (1981/2), chair of the scientific advisory committee of the US renal data system, National Institutes of Health (1988–93) and president of the American Society for Artificial Internal Organs (1997/8) and the Northwest Renal Society (2000–06).

Professor Sir Christopher Booth

Kt FRCP (b. 1924) trained as a gastroenterologist, was professor of medicine at the Royal Postgraduate Medical School, Hammersmith Hospital, London (1966–77) and director of the MRC's clinical research centre, Northwick Park Hospital, Harrow (1978–88). He was the first convenor of the Wellcome Trust's History of

* Contributors are asked to supply details; other entries are compiled from conventional biographical sources.

Twentieth Century Medicine Group (1990–96) and was Harveian Librarian at the Royal College of Physicians (1989–97). He is visiting fellow at the Wellcome Trust Centre for History of Medicine at UCL.

Professor John Stewart Cameron CBE FRCP (b. 1934) trained at Guy's Hospital (now part of King's College Medical School) where he spent most of his working career in research and care in renal diseases as professor of renal medicine. His work on dialysis began in 1962 at Cornell University, New York, and he has also been involved extensively in transplantation research as well as general nephrology. He is author of a number of articles on the history of nephrology. See, in particular, Cameron (2002).

Dr William R Cattell MD FRCPE FRCP (b. 1928) qualified at Edinburgh University in 1951. After junior posts in Edinburgh, national service and posts at the Brompton Hospital, London and UCH, he was appointed medical lecturer at Bart's in 1959 (senior lecturer, 1963); held a Rockefeller fellowship in Boston, MA (1963/4). He established NHS and academic departments of nephrology at Bart's in 1969 and retired in 1991 as

a senior consultant nephrologist and senior physician to St Bartholomew's Hospital, London.

Mr Eric Collins

FIOD (b. 1936) had a background in electronics in the Royal Air Force (RAF) (1953–57), where he was a radar specialist to the joint experimental helicopter unit, which took part in ill-fated action in Suez in 1956. On leaving the RAF he became a field engineer with Decca Navigator and was engaged in several of the H-bomb tests on Christmas Island (Kirikibati) (1957–59). He was pharmaceutical sales representative with Knoll and British Schering (1960–68) and specialist sales engineer with Rank Electronic Tubes (1968–70), leading to an offer from Gambro to establish their business in the UK in 1970, where he was managing director.

Mrs Ann Eady

(b. 1944) qualified at the Royal Free Hospital (RFH) school of nursing, she worked as a student nurse, and later staff nurse in the dialysis unit, RFH Hampstead (1966–68), and then as a sister in the renal unit at Guy's Hospital, London. She was a carer in home dialysis to her husband, Robin Eady (1968–87). She is currently a nurse specialist in contraception at the Margaret Pyke Centre, London.

Professor Robin Eady

FRCP, FMedSci (b. 1940) graduated in medicine at Guy's. As a Wellcome Trust training fellow, he worked in departments of medicine and biological structure at the University of Washington. He later became head of the department of cell and molecular pathology and dean at St John's Institute of Dermatology, St Thomas' Hospital, London. He is currently emeritus professor of experimental dermopathology, King's College London, and honorary consultant dermatologist, Guy's and St Thomas' NHS Foundation Trust. His main research interest is in genetic skin disorders, and he founded the national epidermolysis bullosa diagnostic laboratory at St Thomas'. He began dialysis under Belding Scribner in February 1963, later moving to Edmonton, Canada, and the Royal Free Hospital, London, under the care of Stanley Shaldon and Rosemarie Baillod. After almost two decades of home dialysis (1968–87) cared for by his wife, Ann Eady, including a period in Seattle (1972/3) he received a cadaveric renal transplant in Oxford.

Miss Freda Ellis

(b. 1931) was a ward sister in the professorial medical unit at the Leeds General Infirmary (1957–86).

Professor John Galloway

LLM (b. 1942) was senior administrative officer at the MRC (1975–86); the Cancer Research campaign (1986–89); Nuffield Foundation (1989–93); Eastman Dental Institute (1993–96); and has been professor of biology at UCL, head of the dental team studies unit, Eastman Dental Hospital and expert adviser at the joint UCL/UCLH Biomedical Research Centre, UCL, since 1996.

Mrs Diana Garratt

(b. 1960, née Northover) started peritoneal dialysis at St Albans City Hospital in September 1969. She transferred to the Hammersmith Hospital and then Hampstead General Hospital, part of the Royal Free Hospital (RFH). In November 1969 her haemodialysis began at the Royal Free Hospital renal unit, London, after Dr Rosemarie Baillod created an AV leg shunt. She started home haemodialysis, five days a week, in January 1970, cared for by her mother, Dr Jean Northover. She attended school full-time, and undertook voluntary work with occupational therapy, St Albans City Hospital. She was employed as a ward clerk (1979–81), and studied at the Chelsea School of Chiropody (1981–84), qualifying as a state registered chiropodist, and worked within the NHS and then in private practice. In February

1985 she received a cadaveric renal transplant at the RFH. She taught computing and Internet skills at various Hertfordshire colleges and continued with a small domiciliary chiropody practice. In 2008 her renal transplant began to fail and she returned to the transplant list. Mrs Diana Garratt wrote: ‘I am not a one-dimensional patient, “the renal failure in bed one”, but someone who has survived and continues to live with renal failure. Dialysis is a successful and proven treatment and even in the relatively primitive days of the 1960s and early 1970s when dialysis took many more hours per week than it does now, before erythropoietin, and the knowledge of vitamin D analogues and bone disease, patients did attend school and work.’ Note on draft transcript, 18 July 2008.

Dr Henry John Goldsmith
MD FRCP (b. 1924) qualified at Guy’s Hospital in 1947 and held various junior posts in general medicine, neurology and paediatrics, served in the Royal Army Medical Corps in the Middle East (1948/9), worked with Willem Johan (Pim) Kolff at Cleveland Clinic, Ohio (1959) and Robert Kark in the University of Illinois, Chicago (1959–60). He became consultant to the artificial kidney unit and in general medicine,

Sefton General Hospital, Liverpool Royal, in 1961 and founded the Merseyside regional association for kidney research (1964), the first of its kind in the UK, and the second UK unit to introduce home haemodialysis. He moved to the Royal Liverpool University Hospital in 1979, where he directed the Mersey regional renal unit and became manager of the hospital (1986–89).

Dr Roger Greenwood
MD FRCP (b. 1947) qualified in medicine at the University of Bristol in 1976, following a first career in aeronautical engineering. After training in Manchester and Bart’s, London, he moved to Stevenage in 1988 to establish a new renal service for Hertfordshire and Bedfordshire, and has been clinical director of the Lister Renal Unit there since 1991. His research interests include haemodiafiltration, enhanced self-care dialysis and end-of-life issues. He was president of the British Renal Society (1997–2000) and chair of the Kidney Alliance (2003–07). He was lead author of the Kidney Alliance document *Renal Failure: A framework for planning and service delivery* (2001), which prompted government to produce the Renal National Service Framework (NSF) (2004/5). He subsequently became a member of the Renal NSF, an

external reference group, chairing the module addressing end-of-life and palliative care issues in kidney patients.

Mr David Hamilton

FRCPS (Gla), graduated from Glasgow in 1963, trained in organ transplantation with Sir Peter Medawar in London and later studied the history of medicine at the University of Oxford. He was a senior surgeon at the transplant unit of the Western Infirmary, Glasgow, Scotland and the first director of the Wellcome Unit for the History of Medicine at Glasgow University.

Mrs Olga Heppell

was a nurse and renal patient who received the first home haemodialysis in Europe in November 1964, under the supervision of Dr Stanley Shaldon at the Royal Free Hospital, London. She used one of two modified two-layer Kiil artificial kidneys manufactured by her husband, Ron Heppell in Autumn 1964 at the Royal Free, the first of which was sold to Hugh de Wardener at Charing Cross Hospital, London. Ron Heppell went on to establish the company Heppell Engineering, Essex, UK, for the manufacture and distribution of dialysis machines in 1965/6.

Dr Nicholas Hoenich

PhD Csci Cphys MInstP (b. 1946) graduated in physics from the University of London in 1965 and subsequently obtained a PhD at Newcastle University in 1980. His interests are in the technology of dialysis and membranes. After a short period of working with Dr William Cattell at St Bartholomew's Hospital, London, he worked as a scientific/senior scientific officer in the department of medicine, Newcastle University (1968–80) prior to being appointed to a lectureship in clinical science there. He was also president of the Association of Renal Technicians (1985–2007).

Mr John Hopewell

FRCS (b. 1920) qualified at King's College Hospital, London, in 1943 and undertook surgical and urological training at King's College Hospital, Royal Army Medical Corps (1945–48); Great Ormond Street Hospital (1950–55); University of California, San Francisco (1955–67). He was appointed surgeon at the Royal Free Hospital, London, in 1957 with a remit to establish a department of urology, and was founder and director of the renal unit there (1957–66); and a founder member of the British Transplantation Society (1971).

Professor David Kerr

CBE FRCP FRCPE (b. 1927) was professor of renal medicine at Newcastle upon Tyne (1968–83), and professor of renal medicine and dean, Hammersmith Hospital, London (1984–92).

Dr Felix ID Konotey-Ahulu

MD FRCP DTMH (b. 1930), was born in Ghana, trained at Westminster Hospital School of Medicine, University of London, and did postgraduate work at Liverpool School of Tropical Medicine (1962) and Christ's College, Cambridge (1970/1). He was research fellow in the department of medicine, Royal Free Hospital (1964/5); consultant physician at the Korle Bu Teaching Hospital, Accra, Ghana (1965–79); director, Ghana Institute of Clinical Genetics (1973–79); consultant physician and genetic counsellor in haemoglobinopathies in Harley Street, London (1979–2009), and the Cromwell Hospital, London (1983–2005); and Kewgyir Aggrey distinguished professor of human genetics, University of Cape Coast, Ghana (2000–09).

Professor Monty Losowsky

FRCP (b. 1931) graduated from the University of Leeds in 1955, worked in Leeds, London, the University of Paris and Harvard University, Boston, Massachusetts,

before being appointed professor of medicine in Leeds in 1969, dean of medicine and dentistry (1989–94), later emeritus. He has been visiting professor, University of Queensland, Australia (1996/7), and is at present executive chairman of the Thackray Museum, Leeds.

Professor Kenneth (Ken) Lowe

CVO MD DSc FRCPE FRCP (b. 1917) was medical registrar and tutor at the Postgraduate Medical School, Hammersmith Hospital, London (1947–52) and emeritus professor of medicine, University of Dundee.

Professor Sir Netar Mallick

DL FRCP FRCPI FRCSE qualified at Manchester University in 1959. From 1965 he planned the renal unit in Cardiff, was a member of the Minister of Health's working party on treatment for renal failure (1965–67), and became consultant physician and professor of renal medicine in Manchester (1967–2000), later emeritus. He was medical director of Central Manchester Trust (1997–2000), medical director of the national advisory committee on distinction awards (1999–2003) and on clinical excellence awards (2003–06). He was High Sheriff of Greater Manchester (2002/3), and was knighted in 1998. He has been president of the Renal

Association of Great Britain and Ireland, adviser to the government on renal disease, president of the nephrology board, Union European des Médecins Spécialistes and chairman of the European Dialysis and Transplantation Association Registry.

Dr Francis (Frank) Marsh
MA FRCP (b. 1936) graduated in natural sciences, at Gonville and Caius College, Cambridge, in 1957 and qualified in medicine and surgery in 1960. Following junior medical and research posts at the London, Kent and Canterbury and Royal Free hospitals, he was appointed consultant physician, nephrologist and senior lecturer in medicine at the London Hospital Medical College in 1971. He became dean of medical studies and member of the council of governors, London Hospital Medical College (1990–95); chair of the North East Thames regional medical advisory committee (1986–90); member of the joint formulary committee of the British National Formulary (1986–2008); member of the executive committee of the Renal Association and of the specialist advisory committee on renal disease (joint committee on higher medical training). He is currently chair of the board of directors of the American University of the Caribbean.

Professor Denis Melrose
MRCP FRCS (1921–2007) was professor of surgical science at the Postgraduate Medical School, London, and surgical registrar at the Hammersmith Hospital, London (1968–83), later emeritus.

Dr Jean Northover
PhD (b. 1928, née Payton) graduated in anatomy and physiology at the University of Birmingham; worked in industrial toxicology as physiologist technical officer at ICI, Welwyn, Hertfordshire, working mainly on organophosphates (1949–53); junior lecturer at the London Hospital Medical College in 1965 and worked for her PhD (1958) on fortification of physiological saline for maintaining isolated organs; lecturer in the department of forensic medicine under Dr Francis Camps (1958–63), working on the estimation of barbiturates and other substances in post mortem specimens. In 1970, she became the first ‘home dialysis mother’ of a prepubertal child within the NHS when her eldest child, a patient of Dr Rosemarie Baillood at the Royal Free Hospital, was aged 9 and began haemodialysis at home.

Dr Chisholm Ogg
MD FRCP (b. 1938) qualified at Guy’s Hospital Medical School in 1961, trained in nephrology in

1964 at the Institute of Urology with Dr A M Joekes and Dr A R Harrison and continued at Guy's in 1969, where he remained as director of renal services until his retirement in 1998. During his career he published approximately 150 papers, mainly on the clinical aspects of renal disease, including dialysis and transplantation.

Miss Lesley Pavitt

(b. 1944) trained as a nurse at Guy's Hospital (1963–66) and joined the renal unit at the Royal Free Hospital in 1967. She was promoted to sister in 1968 and clinical teacher in 1974. She was a founder member of the European Dialysis and Transplant Association and later a member of the committee (1979–93). She became a clinical teacher and nursing officer at St Bartholomew's Hospital renal unit in 1977 and was deputy director of nursing, St Peter's group (1987–95).

Professor John Pickstone

PhD (b. 1944) trained in biomedical sciences and in history and philosophy of science at UCL and Chelsea College, London (1973). Since 1974 he has worked at the University of Manchester Institute of Science and Technology and University of Manchester, where he founded the Wellcome Unit and the Centre for the History of Science,

Technology and Medicine in 1986. Since 2002 he has been Wellcome research professor at the centre. His present projects include the recent histories of cancer, the artificial hip and the NHS in Manchester.

Dr Margaret Platts

FRCP (b. 1924) trained and qualified in Sheffield in 1948 and practised mainly in the department of medicine at Sheffield University, (1948–83) where, as consultant nephrologist, she inaugurated dialysis and the nephrology department in 1963. She spent a year in Baltimore, Maryland, in 1959, and for a short period, in Seattle, Washington, as a visiting fellow, working with Belding Scribner.

Professor Leslie Pyrah

CBE (1899–1995) was honorary assistant surgeon, Leeds General Infirmary (1934–44); surgeon with charge of out-patients (1944–50); senior consultant surgeon, department of urology, Leeds General Infirmary (1950–64), honorary director, MRC unit (1956–64); lecturer in surgery, Leeds University (1934–56); professor of urological surgery (1956–64), later emeritus.

Professor Belding Scribner

MD (1921–2003) qualified at Stanford University School of Medicine in 1948, and was

professor of medicine at the University of Washington School of Medicine (1951–90). He designed, with Wayne Quinton, a U-shaped device made of Teflon, later called the Scribner shunt, in 1960. See Lenzer (2003); Blagg (2006).

Miss Mary Selsby

(b. 1934) trained and nursed at the Eastman Dental Hospital, London (1953–59), and trained as a nurse at the Royal Free Hospital (1962–5) and as a midwife at the Royal London and St Mary's Hospital (1966/7). She was a health visitor in the London Borough of Camden (1968–70), a home dialysis administrator and later renal services manager at the Royal Free Hospital (1970–96). She was a founder member, committee member, newsletter editor and journal editor of the European Dialysis and Transplant Nurses Association (1974–86).

Professor Stanley Shaldon

MD FRCP (b. 1931) qualified at Queen's College, Cambridge and trained at the Middlesex Hospital, London, and later as houseman and registrar at the Postgraduate Medical School, Hammersmith Hospital, London, in the department of medicine with Professor John McMichael. He was lecturer in medicine (nephrology) at the Royal Free

Hospital Medical School (1960–65); consultant physician at the Royal Free Hospital (1965–66); medical director, National Kidney Centre, London (1966–74); and professor of nephrology, University of Montpellier, France (1974–96).

Professor E M (Tilli) Tansey

PhD PhD FMedSci HonFRCP (b. 1953) is convenor of the History of Twentieth Century Medicine Group and professor of the history of modern medical sciences at the Wellcome Trust Centre for the History of Medicine at UCL.

Professor Neil Turner

FRCP (b. 1956) qualified at the University of Oxford in 1980 and has been professor of nephrology and consultant in renal medicine at Edinburgh University and Royal Infirmary since 1998. He has a scientific research group working on autoimmunity in the MRC centre for inflammation, Queen's Institute for Medical Research, Edinburgh. He established EdRen, the website of the Edinburgh renal unit, (www.edren.org) in 2000 and has steered the renal patient view project, in which patients access their own results on the web, since its initiation in 2004. He has been chairman of Kidney Research UK since 2007.

Dr John Turney

MD FRCP (b. 1948) qualified at Cambridge and King's College London, held posts in London and Birmingham, including Wellcome research fellow at King's College London, where he worked on prostacyclin, coagulation and dialysis (1978–84). He was consultant renal physician, Leeds General Infirmary (1983–2005). Since 2006, he has been pursuing postgraduate studies at the Centre for the History of Science, Technology and Medicine, University of Manchester.

Professor Hugh de Wardener

CBE FRCP (b. 1915) qualified at St Thomas' Hospital in 1939 and joined the Royal Army Medical Corps. After the war, he returned to St Thomas' as a lecturer and started work on renal physiology, salt and water balance, and acute renal failure. He was chair of medicine at Charing Cross Hospital, London (1960–81), later emeritus.

Index: Subject

- abortion *see* septic abortion
- academic medicine, 30–2, 34, 35–6
- accidental haemorrhage, concealed,
82, 84
- acute cortical necrosis, 26
- acute renal failure, xxiii, 7, 80–3, 84
conservative regimen *see* Bull
conservative regimen
dialysis, 8–12, 18–19, 24, 27,
34–5, 81–3
origin of term, 17
- acute tubular necrosis, 80, 81
- age limits
dialysis, 67, 70, 71, 73
home haemodialysis, 65
- air ambulances, 8–9
- aluminium, 53–6
- Alwall glass cannula shunt, 14–15
- Alwall kidney, 15, 19–20, 20–2
- American Journal of Medicine*, 10
- American Society for Artificial Internal
Organs (ASAIO), 17, 27
- American Society for Clinical
Investigation, 29
- amyloidosis, dialysis-related, 68, 75
- antepartum haemorrhage, 26
- anuria, acute, 80, 81, 82–3
see also acute renal failure
- arteriovenous (AV) shunts, xxiii
Alwall glass cannula, 14–15
leg, 49, 58
Scribner, 5, 14–15, 16, 17, 32
- artificial kidneys (dialyzers)
commercially produced, 38–41
copper parts, 59
flat plate/bed, 20, 21, 50
home haemodialysis, 57, 58
mini-coil, 13
origins, 44–5
rotating drum, 8, 10, 12–13, 15, 72,
79–83, 84–5
twin-coil, 13, 19, 20, 22, 25,
27, 38
see also specific named machines
- ASAIO *see* American Society for
Artificial Internal Organs
- ascites, 14
- atheroma, 75
- attendance allowance, 62
- Australia, 55, 58–9
- Australia antigen test, 49–50, 51, 52
- autonomy, patient, 43, 68
- AV shunts *see* arteriovenous (AV)
shunts
- bacteraemia, 64
- Baxter–Travenol twin-coil
artificial kidney, 27
- Belgium, 74
- bicarbonate dialysate, 66
- biochemistry, 22–3, 36, 81–2, 85
- bioethics, 70
- biopsy, renal, 17
- Birth of Bioethics, The* (A R Jonsen), 70
- black population, 67–8
- blind patients, 69
- blood leaks, 22, 64–5, 82
- blood pressure, high *see* hypertension
- blood transfusions
hepatitis B testing, 51
mismatched, 7, 18, 82, 84
- BMJ see British Medical Journal*
- bone disease, 53–6, 75
- Borst–Bull regimen *see* Bull
conservative regimen
- Boston, MA, 11–12, 23, 29

- British Medical Journal (BMJ)*, 30, 46, 69, 79
- British Urological Association, 11
- Bull conservative regimen, 4, 8, 15, 18, 19, 80–1, 83, 85
- cabins, home dialysis, 61–2
- calcifications, 75
- Cambridge, 11–12
- Cambridge Instruments artificial kidney, 38
- CAPD *see* continuous ambulatory peritoneal dialysis
- cardiac catheters, 34
- cardiac failure, congestive, 14
- cardiac surgery pump, 36
- cardiology, 7
- cardiovascular disease, 68–9, 75
- carpal tunnel syndrome, 75
- cataract surgery, 6
- cellophane tubing, 21, 22, 25, 35, 44–5, 81, 82, 85
- cellulose Pall filter, 59
- cerebral oedema, 15
- Checkpoint Charlie, Berlin, 77
- children, home haemodialysis, 56–60, 62–3, 64, 65, 67
- chloride measurement, 37–8, 84
- cholesterol, 75
- chronic renal failure, xxiv, 26
early dialysis, 15, 17, 19–20, 27
- Cleveland Clinic, Cincinnati, OH, 30
- clinical physiology, xxiii, 6
Clinical Science, 80–1
- Cochrane review, 66
- collodion, 45
- communities of practice, 6
- conservative management
acute renal failure (Bull regimen), 4, 8, 15, 18, 19, 80–1, 83, 85
- chronic renal failure, 76, 77
- continuous ambulatory peritoneal dialysis (CAPD), 4, 46
- copper contamination, 59–60
- cost effectiveness, 71
- criminal abortion *see* septic abortion
- crush syndrome, xxiii, 8, 84
- cystinuria, 10
- de-aerator, 57
- de-ionization, water, 55, 56
- dementia, dialysis, 56
- Denmark, 74
- Department of Health and Social Security (DHSS), 39, 40
- diabetic patients
access to dialysis, 69, 70, 73, 77
autonomy, 43, 68
- dialysate fluid
copper contamination, 59–60
making up, 22, 25, 37–8, 67
- dialysis
antagonism towards, 12, 27, 37
equipment purchasing, 39, 40
origins, 44–5, 46–7
population demographics, 67–8, 70
scientific basis, 44
- dialysis disequilibrium, 24, 64
- dialysis encephalopathy, 55–6
- dialysis machines *see* artificial kidneys
- dialysis reactions, 58–60, 64
- ‘dialysis shoulders,’ 68, 75 *see also*
amyloidosis, dialysis related
- dialyzer *see* artificial kidney
- diet, 6, 62, 69, 80, 85
- diffusion, non-ionic, 10
- Dista Products, Speke, 59–60
- Drake Willock artificial kidney, 39
- drug addicts, 49
- Dylade artificial kidney, xxiv, 39, 59, 61

- economics
 constraints, 6, 46, 72
 impact of hepatitis, 47–8, 52
 universal access to dialysis, 74
see also funding
- Edinburgh, 26, 51
- Eel flame photometer, Cambridge,
 23, 24
- elderly patients, 70, 71, 73, 77
 frail, 76, 77
- electrolytes
 imbalances, 9, 83, 85
 measurements, xxiii, 15, 23–4,
 37–8, 84, 85
- Elga Group, 59
- encephalopathy, dialysis, 55–6
- end-stage renal disease (ESRD), 42
 services, 5
see also chronic renal failure
- ESRD *see* end-stage renal disease
- European Dialysis and Transplant
 Association (EDTA), 14, 77
- Evening News*, 31
- exsanguination accidents, 64–5
- family, role in home haemodialysis,
 58–62
- femoral vein, Seldinger catheters, 29
- flame photometers, 15, 19, 22–4, 37,
 80, 84, 85
- fluid imbalances, 83, 85
- formalin, 50, 57, 64
- fractures, spontaneous, 53–4 *see also*
 bone disease,
- France, 18, 39, 53
- funding
 dialysis, 27–8, 40
 home dialysis, 46, 61, 62
 impact of hepatitis, 47–8, 52
 research, 6, 80
see also economics
- Gambro artificial kidney, 39–40, 50
- Gambro UK, 76
- gastrodialysis, 9
- Germany, 39, 44, 45, 53, 77
- Ghana, 41–2
- Glasgow Royal Infirmary, 12–13
- glomerulonephritis, acute, 30
- grants, research, 27–8
- Guy's Hospital, London, 19–20, 33,
 37, 49–50, 52
- haemorrhagic nephroses, 82
- Hammersmith Hospital, London, 4,
 8–11, 30, 36, 84–5
 clinical physiology, 6
 conservative regimen for acute renal
 failure, 4, 8, 15, 18, 80–1, 83, 85
 electrolyte measurements, 15, 23,
 84, 85
 ex-trainees, 41, 55
 Kolff rotating drum kidney, xxiii,
 8–9, 12, 13, 15, 79–83, 84–5
 patient experience, 37
- hard water syndrome, 64
- Hartnup disease, 10
- heparin, 22, 44–5
- hepatitis, xxiv, 47–53
 isolation units, 48, 50
 silent carriers, 49
 vaccine, 53
- hepatitis B, 48–51
- hepatitis C, 48
- Heppell dialyzer, 40
- 'Herceptin syndrome,' 71
- high blood pressure *see* hypertension
- hips, artificial, 6
- hirudin, 45
- History of Twentieth Century Medicine
 Group, Wellcome Trust, 3
- holidays, 59–60, 77
- Holland *see* Netherlands
- home adaptations, xxiv, 61–2

- home haemodialysis, xxiv, 4, 45–6, 53, 56–64, 65–8
 - aluminium bone disease, 54–5, 56
 - empowering patients, 43, 68
 - equipment and supplies, 57, 58, 61–2
 - hepatitis and, 49, 50
 - pressure monitors, 72–3
 - provision of machines, 39
 - starting, 60–1
 - stressful nature, 60, 65
 - support, 58, 61, 62–4
 - teaching patients, 33, 61, 65, 68
 - US, 66–8, 72–4
- housing, 62
- hyperpotassaemia, 9
- hypertension (high blood pressure), 37, 41, 67–8

- incidence rates, dialysis, 70, 71, 74
- industry, xxiv, 38–41, 76
- infections, 85
- Institute of Child Health, UCL, 3
- Institute of Urology, University of London, 25
- intelligence (IQ), patient, 67, 68
- International Congress of Nephrology, first (Evian 1960), 14, 15, 29–30
- International Society of Nephrology, 19, 55, 70
- isolation units, hepatitis, 48, 50
- Italy, 39, 53, 77

- Jagiello University, Cracow, Poland, 8

- Kampen, Netherlands, 23, 84
- Kent and Canterbury Hospital, Kent, 34
- Khartoum, Sudan, 56
- kidneys
 - artificial *see* artificial kidneys
 - post mortem retrieval, 24
 - surgical decapsulation, 83
 - transplantation, xxiv, 25–6, 53, 60, 65
- Kiil flat plate dialyzers (Kiil boards), 14, 20, 21, 43
 - hepatitis risk, 50
 - home dialysis, 60, 61, 62
 - securing venous lines, 32
- King's College Hospital, London, 35, 36, 52
- Kolff–Brigham rotating drum artificial kidney, 12
 - Usifroid version, 10, 12
- Kolff rotating drum artificial kidney, xxiii, 8, 13, 15, 72, 79–83, 84–5
- Kolff–Travenol twin-coil kidney, 12, 13, 25, 38
- Kolff twin-coil artificial kidney, 19, 20, 38
- Korle Bu Hospital, Accra, Ghana, 42
- Kuratorium für Heimdialyse und Nierentransplantation, 45

- laboratory, biochemistry, xxiii, 41–2, 81–2
 - Lancet*, 30, 47–8, 52–3, 55, 80, 83
- Leeds, xxiii, 4, 11–12, 29, 35
 - biochemical measurements, 36
 - biochemistry, 22–4
 - kidney transplantation, 25–6
 - MRC metabolic disturbances in surgery unit, 12, 36
 - patient selection, 71
 - technicians, 34, 35
- Leeds General Infirmary, 12, 36–7
- leg shunts, 49, 58
- Lend Lease, 79
- Life* magazine, 70
- liver, artificial, 36
- Liverpool, 24, 48–9
- local authorities, 61
- London Hospital, 20, 30–2, 35, 51
- Lucas Medical artificial kidney, 38, 39

- magnesium salt, 25
 Manchester, 6, 23, 47–8
 manometer, mercury U-loop, 73, 74
 Mayo Clinic, Rochester, MN, 24, 26, 68
 Medical Research Council (MRC),
 xxiii, 6
 attitude to dialysis, 12, 36, 37
 metabolic disturbances in surgery
 unit, Leeds, 12, 36
 Medicare end-stage renal disease
 (ESRD) programme, 70, 73, 74
 Milton Roy dialysis machine, 39, 40
 Ministry of Health, 20, 37, 47, 52
 Mount Sinai Hospital, New York, 8
 MRC *see* Medical Research Council
 multidisciplinary team, 5
- National Institute for Health and
 Clinical Excellence (NICE),
 66, 71
 National Institutes of Health
 (NIH), 27
 National Kidney Centre, London,
 14, 45
 needles, insertion of, 33, 49
 nephrologists, 23, 26–7, 28–32, 34–5
see also physicians
 nephrology, 29–30, 42–3
Nephrology Dialysis Transplantation,
 19, 45
 Netherlands, the, 8, 15, 18, 23, 84
New York Times, 74
 Newcastle, xxiii, 4, 15, 20–2, 30, 40
 bone disease, 54–5
 NICE (National Institute for Health
 and Clinical Excellence), 66, 71
 nightly haemodialysis, 74
 NIH (National Institutes of
 Health), 27
 nocturnal haemodialysis, 73–4
 Northwest Kidney Centers (NKC)
see Seattle Artificial Kidney Center
- nurses, 28, 32–4, 42, 80
 agency, 50
 dealing with blood leaks, 64–5
 home dialysis support, 60–3, 64
 non-registered, 34, 43
 specialist, 32–3
- oil leak, 20
 Oxford University Press, 17
- Pall Corporation, Brooklyn, NY, 59
 palliative care, 76
 parathyroid hormone, 75
 patients, 31
 employment of, 62, 73–4
 empowering, 43, 68
 illiterate, 66
 intelligence, 67, 68
 male/female shared rooms, 46
 perspective, 37–8, 56–7, 58,
 63, 64
 selection, xxiv–xxv, 65, 69–74, 77
 starting home dialysis, 60–1
 teaching home dialysis, 33, 61,
 65, 68
 Pembury Hospital, Kent, 20
 peritoneal dialysis, 18, 19, 20, 26
 continuous ambulatory (CAPD),
 4, 46
 pre-transplant, 25
 Peter Bent Brigham Hospital, Boston,
 MA, 11–12
 photometer, flame, 15, 19, 22–4, 37,
 80, 84, 85
 physicians, xxiii, 6–7, 20, 23
see also nephrologists
 Piriton[®], 58
 placental abruption (accidental
 haemorrhage), concealed, 82, 84
 Plymouth, 54
 poisonings, 82
 polycystic kidney disease, 19–20

- population (dialysis)
 - demographics, 67–8, 70
 - patients per million (ppm), 70–1, 74
- postwar period, xxiii, 6, 8, 79
- potassium, 9, 84
- potassium citrate, 83
- potassium-binding resins, 9
- Presbyterian–St Luke’s Hospital, Chicago, 30
- pressure monitors, 72–3, 74
- prevalence rate, dialysis, 71
- Princess Mary’s Royal Air Force Hospital *see* Royal Air Force (RAF) Hospital, Halton
- pyrogenic reactions, 64

- Radio Spares, 74
- RAF *see* Royal Air Force
- rationing of dialysis, xxv, 5, 73
 - see also* selection, patient, universal access
- rehabilitation, 73–4
- Renal Association, 3, 29
- renal biopsy, 17
- renal blood flow, 34
- renal physiologists, 27, 30
- renal replacement therapy, 53
- renal units, 5
- reverse osmosis, 64
- Rhône-Poulenc artificial kidney, 50
- rigors, 25, 85
- Royal Air Force (RAF) Hospital, Halton, 4, 12, 13, 19
- Royal Free Hospital, London, 35, 41
 - dialysis patients, 31, 38
 - hepatitis, 48, 49, 50–1
 - home haemodialysis, 59, 60–3
 - kidney machines, 22, 34, 43
 - nephrologists, 28–9, 30
 - nurses, 32–3, 34
- Royal Society of Medicine, 58
- Royal Victoria Hospital, Montreal, 8

- SAKC *see* Seattle Artificial Kidney Center
- salt-restricted diet, 69
- Scandinavian Society for Kidney Research, 29
- schools, 62–3, 64
- science, dialysis, 44
- Scribner arteriovenous shunt, 5, 14–15, 16, 17, 32
- Seattle, WA, xxiv–xxv, 15, 26–8, 56, 69
 - home dialysis programme, 66–8
 - patient selection, 70, 71–4
 - Veterans’ Administration (VA) Hospital, 27
- Seattle Artificial Kidney Center (SAKC) (later Northwest Kidney Centers), 15, 27–8, 67, 70
- Second World War, xxiii, 7, 8, 44, 79, 84
- Sefton General Hospital, Liverpool, 48–9
- Seldinger catheters, femoral vein, 29
- Seldinger technique, 34
- selection, patient, xxiv–xxv, 65, 69–74, 77
- septic abortion (including criminal abortion), xxiii, 7, 18, 24, 82, 84
- Sheehan’s syndrome, 24
- Sheffield, 54, 55–6
- shoulders, dialysis, 68, 75
- shunts *see* arteriovenous (AV) shunts
- silastic rubber tubing, 15
- Skeggs–Leonards kidney, 14, 24
- social security benefits, 62
- social worth, selection based on, 71
- Società Italiana di Nefrologia, La, 29
- Société de Nephrologie, La, 29
- Société des Eaux d’Evian, 29
- Société Usifroid Paris, 10
- sodium measurement, 15, 24, 84
- sports participation, 63

- St Bartholomew's Hospital, London
(Bart's), 30, 35, 52
- St Mary's Hospital, London, 25
- suicide, 65
- sulphonamide anuria, 81, 82
- surgeons, xxiii, 6–7, 10–11, 18, 20,
24, 34–5
- systemic lupus erythematosus
(SLE), 67
- technicians/technical staff, 34, 35, 43,
58, 59, 80
- Teflon shunt, 14–15
- telephones, home, xxiv, 62
- toxaemia, 24
- transplant nephrologist, 30
- transplantation, kidney, 25–6, 53,
60, 65
- trauma, 7, 18
- travel costs, 62
- tuberculosis, renal, 24
- UCL (University College London), 3
- ultrafiltration, 14, 15
- United States (US), xxiv–xxv, 7, 18
home haemodialysis, 66–8, 72–4
patient selection, 70–4
see also Seattle
- universal access, 70, 73, 74, 76
- University College London (UCL), 3
- University of Washington,
see Washington state
- uraemia, 24
- urea, blood, 41, 42, 85
- urological surgery, xxiii, 11, 12, 18,
23, 24
- Usifroid rotating drum artificial
kidney, 10, 12
- vitamin D, 75
- vomiting, 57
- Washington state, 28, 67–8, 70
University of Washington, WA,
27, 67
see also Seattle
- water, 53–6
de-ionization, 55, 56
imbalance/overload, 83, 85
softeners, 55, 56, 58
treatment, 54–5, 64
- Watson-Marlow artificial kidney,
38–9, 40
- Wellcome Trust, 3
- Westminster Hospital, London, 35,
41, 50–1
- World War II *see* Second World War

Index: Names

Biographical notes appear in bold

- Ablo, Attilo, 41
Ackrill, Peter, 47
Addis, Thomas, 26
Adu, Dwomoa (Jo), 42
Agatha (technician), 43
Alwall, Nils, xxiii, 14–15, 17, 19–20, 22, 44
Anderson, John, 35
Anim-Addo, Yaw, 42
Auty, Brian, 35
- Babb, Les, 39, 67
Baillod, Rosemarie, 22, 33, 34, 40, 46, 49, 50, 53–4, 57, 58, 60, 61, 62, 64, 65–6, 69–70, 74–5, **103**
Balme, Richard (Dickie), 20
Banting, Sir Frederick, 44
Berlyne, Geoffrey Merton, 47
Best, Charles, 44
Bewick, Mick, 52
Black, Sir Douglas, 47, 52–3
Blagg, Christopher, xxiv, 8, 10, 11–12, 15, 23, 26–8, 35, 39, 46, 56, 64, 66–8, 69, 70, 71–2, 73–4, **103**
Blomfield, Jeanette, 58–9
Booth, Sir Christopher, 8–11, 30, 35–6, 66, **103–4**
Borst, Gerd, 18, 85
Brun, C, 17
Brun, Hans, 81
Bull, Graham (later Sir Graham), 4, 8, 15, 79, 80, 82, 83, 84–5
Bywaters, Eric, 8, 19, 79, 82, 83, 84
- Cameron, Stewart, 10, 11, 15, 17–20, 23, 24, 29, 30, 33, 37, 42–3, 44–5, 49, 52, 68, 69, 70, 72, 74, **104**
- Caroline (dialysis patient), 67
Cattell, William, 30, 32, 37, 52, 76, 77, **104**
Chisholm, Geoff, 15
Collins, Eric, 38–9, 40, 50, 76, **104**
Cook, Nancy, 69
Cossart, Yvonne, 51
Crawford, M A, 10
- Darmady, Michael, 19
Dempster, James (Jim), 25
Doll, Sir Richard, 66
Dollery, Sir Colin, 37
Domingo, W Ruud, 23, 84, 85
Douglas, Colin, 51
Drake, Richard, 39
- Eady, Robin, 37–8, 41, 43, 64, 70, 72, 77, **105**
Eady, Teresa Ann, 32, 33, 56, 64–5, 77, **104**
Edwards, Eric, 24
Elliot, Walter, 22
Ellis, Arthur, 35
Ellis, Freda, 71, **105**
Eschbach, Joe, 72
Evans, Barbara, 80
Evans, Bob, 26–7
- Fox, Robin, 53
Fraser, Francis, 35
Fraser, Russell, 79
- Galloway, John, 44, **105**
Garratt, Diana (*née* Northover), 56–7, 58, 59–60, 63, 64, 72, 77, **105–6**
George VI, King, 73
Germaine (technician), 43

- Godber, Sir George, 52
 Goldsmith, Henry John, 24, 30, 48–9, 50, 70, **106**
 Greenwood, Roger, 34, 68, 69, 75, 76, 77, **106–7**
 Grollman, Arthur, 18–19
- Hall, Molly, 22
 Hamburger, Jean, 29, 30
 Hamilton, David, 23, 36, 46–7, 52, **107**
 Harvey, Clifford, 59
 Haviland, James (Jim), 28
 Heppell, Olga, 53–4, **107**
 Hill, Sir Austin Bradford, 66
 Himsworth, Sir Harold, 12
 Hoenich, Nicholas, 25, 40, 70, **107**
 Hopewell, John, 12–13, 25–6, 29, 34, **107**
 Horder, Lord, 35
 Huggins, Charles, 11
- Iversen, P, 17
- Jackson, Ralph (later Sir Ralph), 12–13
 James, Gerry, 41
 Joekes, A M (Jo), 8, 17, 19, 25, 72, 79, 81, 82, 83, 84
 Jones, Sir Francis Avery, 85
 Jonsen, Albert R (Al), 70
- Kark, Robert, 17, 30
 Kennedy, Arthur, 12
 Kerr, David, 15, 20–2, 25, 30, 53, 54–5, 56, **108**
 Kiil, Fredrick, 14, 20
 King, Earl J, 85
 Klyne, W, 85
 Kolff, Willem Johan (Pim), xxiii, 8, 9, 17, 19, 22, 23, 30, 44, 81, 84, 85
 Konotey-Ahulu, Felix I D, 41–2, **108**
- Lambie, Anne, 26, 51
 Losowsky, Monty, 71, **108**
 Loughridge, Lavinia, 30
 Lowe, Kenneth (Ken), 4, 8, 79–83, 84, **108**
 Lyle, Hugh, 58–60
- McCracken, Brian, 11, 35
 McGeown, Mary (Mollie), 12–13
 McMichael, Sir John, 37, 81, 82
 Mallick, Sir Netar, 23, 46, 47–8, 50, 52–3, 60, 66, 73, 74, **108–9**
 Manzler, A D, 59
 Marsh, Francis (Frank), 20, 22, 25, 30–2, 51, 65, **109**
 Melrose, Denis, 36, **109**
 Merrill, John, 11–12, 15, 18, 19, 24, 26, 72–3
 Milne, Malcolm, 8–9, 10–11, 35, 83
 Muehrcke, R C, 17
 Murray, Gordon, 19, 44
- Nordin, B E C, 36
 Northover, Diana *see* Garratt, Diana
 Northover, Jean, 57, 58–60, 63, **109**
- Ogg, Chisholm, 25, 33, 49–50, 52, 72, **109–10**
 Oliver, Des, 42
 Osman, Arnold, 20, 29
- Pall, David, 59
 Parsons, Frank, xxiv, 11–12, 23–4, 35, 36, 71
 Pavitt, Lesley, 32, 33, 43, 49, 50–1, 58, 63–4, 68, **110**
 Peters, John, 23
 Pickstone, John, xxiii–xxv, 5–8, 23, **110**
 Platt, Sir Robert (later Baron Platt of Grindelford), 23
 Platts, Margaret, 55–6, 71, **110**

- Pollak, Victor, 30
Pyrah, Leslie, xxiii, 11, 12, 36, **110**
- Quinton, Wayne, 14–15
- Raper, Peter, 25
Rhoads, Jonathan, 44
Richet, Gabriel, 29
Ritchie, David, 20
Rob, Charles, 25
Rosen, Stanley, 28–9
Rosenheim, Max (Lord Rosenheim),
37, 47, 50
Ross, James Cosbie, 24
- Schreiner, George, 59
Scribner, Belding, xxiv, 9, 10, 14–15,
17, 26–8, 37, 39, 54, 68,
72, **110–11**
- Selsby, Mary, 56, 60–3, 76, **111**
Shackman, Ralph, 10, 11, 37
Shaldon, Stanley, xxiv, 13–15, 17, 24,
28–30, 34–5, 39–40, 41, 42, 43,
45–6, 48, 52, 53, 54, 56, 64, 69,
72–3, 74, 77, **111**
- Sheehan, Harold, 24
Sherlock, Sheila (later Dame Sheila),
15, 28, 29–30, 35, 41
Smart, George, 20–2
Smith, Homer, 17
Snapper, Isidore, 8
Snow, William, 67
Swinney, John, 22
- Tansey, E M (Tilli), xxiii, xxv, 3, 5,
78, **111**
- Thalhimer, William, 44–5
Thoreau, Henry David, 71
Tinker, Jack, 47
Tunbridge, Ronald (later Sir Ronald), 12
Turner, Neil, 25–6, 51, **111**
- Turney, John, xxv, 3–5, 7, 13, 17, 20,
22, 23–4, 25, 26, 32, 33–4, 35,
36–7, 38, 41, 44, 46, 47, 50, 53,
56, 60, 66, 69, 71, 73, 76, 78,
83, **112**
- Ward, Mike, 54–5
Wardener, Hugh de, 37, 40, 47,
48, **112**
- Watschinger, Bruno, 19
Weald, Phyllis, 23
Williams, Robert, 27
Williams, Roger, 36
Willock, Charles, 39
Wilson, Clifford, 30–2
Wing, Anthony, 48
Winney, Robin, 51
Woodruff, Michael, 25–6
Wrong, Oliver, 37

Key to cover photographs

Front cover, top to bottom

Professor Christopher Blagg

Professor Stanley Shaldon

Professor Robin Eady

Mrs Diana Garratt

Back cover, top to bottom

Professor David Kerr

Dr Rosemarie Baillod

Miss Mary Selsby

Dr Stanley Rosen

