

Department of Mathematics  
University College London  
University of London

**THE UNRESTRICTED BLOCKING NUMBER**  
**IN CONVEX GEOMETRY**

Selvinaz Sezgin

A thesis submitted for the degree of  
*Doctor of Philosophy*  
Supervised by Prof. David G. Larman  
University College London  
February 2010

I hereby declare that the work presented in this thesis is my own.

Selvinaz Sezgin

# Abstract

Let  $\mathcal{K}$  be a convex body in  $\mathbb{R}^n$ . We say that a set of translates  $\{\mathcal{K} + \underline{u}_i\}_{i=1}^p$  block  $\mathcal{K}$  if any other translate of  $\mathcal{K}$  which touches  $\mathcal{K}$ , overlaps one of  $\mathcal{K} + \underline{u}_i$ ,  $i = 1, \dots, p$ . The smallest number of non-overlapping translates (i.e. whose interiors are disjoint) of  $\mathcal{K}$ , all of which touch  $\mathcal{K}$  at its boundary and which block any other translate of  $\mathcal{K}$  from touching  $\mathcal{K}$  is called the *Blocking Number* of  $\mathcal{K}$  and denote it by  $B(\mathcal{K})$ .

This thesis explores the properties of the blocking number in general but the main purpose is to study the unrestricted blocking number  $B_\alpha(\mathcal{K})$ , i.e., when  $\mathcal{K}$  is blocked by translates of  $\alpha\mathcal{K}$ , where  $\alpha$  is a fixed positive number and when the restrictions that the translates are non-overlapping or touch  $\mathcal{K}$  are removed. We call this number the *Unrestricted Blocking Number* and denote it by  $B_\alpha(\mathcal{K})$ .

The original motivation for blocking number is the following famous problem:

*Can a rigid material sphere be brought into contact with 13 other such spheres of the same size?*

This problem was posed by Kepler in 1611. Although this problem was raised by Kepler, it is named after Newton since Newton and Gregory had a dispute over the solution which was eventually settled in Newton's favour. It is called the *Newton Number*,  $N(\mathcal{K})$  of  $\mathcal{K}$  and is defined to be the maximum number of non-overlapping translates of  $\mathcal{K}$  which can touch  $\mathcal{K}$  at its boundary. The well-known dispute between Sir Isaac Newton and David Gregory concerning this problem, which Newton conjectured to be 12, and Gregory thought to be 13, was ended 180 years later. In 1874, the problem was solved by Hoppe in favour of Newton, i.e.,  $N(\mathcal{B}^3) = 12$ . In his proof, the arrangement of 12 unit balls is not unique. This is thought to explain why the problem took 180

years to solve although it is a very natural and a very simple sounding problem. As a generalization of the Newton Number to other convex bodies the blocking number was introduced by C. Zong in 1993.

“Another characteristic of mathematical thought is that it can have no success where it cannot generalize.”

C. S. Pierce

As quoted above, in mathematics generalizations play a very important part. In this thesis we generalize the blocking number to the *Unrestricted Blocking Number*. Furthermore; we also define the *Blocking Number with negative copies* and denote it by  $B_-(\mathcal{K})$ . The blocking number not only gives rise to a wide variety of generalizations but also it has interesting observations in nature. For instance, there is a direct relation to the distribution of holes on the surface of pollen grains with the unrestricted blocking number.

# Contents

|   |           |
|---|-----------|
| <b>Abstract</b>   | <b>3</b>  |
| <b>Acknowledgements</b>   | <b>7</b>  |
| <b>Definitions and Notation</b>                                   | <b>8</b>  |
| <b>Introduction</b>   | <b>9</b>  |
| <b>1 The Unrestricted Blocking Number</b>                         | <b>12</b> |
| 1.1 Introduction . . . . .  | 12        |
| 1.2 Principal Results . . . . .                                   | 14        |
| 1.3 The Properties of the Unrestricted Blocking Number . . . . .  | 16        |
| 1.4 The Similarities between $B'_\alpha$ and $B_\alpha$ . . . . . | 57        |
| 1.5 The Differences between $B$ and $B_\alpha$ . . . . .          | 65        |

|     |  |            |
|-----|--|------------|
| 1.6 | Upper and Lower Bound for $B_1$ . . . . .                      | 132        |
| 1.7 | The Applications of the Unrestricted Blocking Number . . . . . | 137        |
| 1.8 | The Blocking Number with Negative Copies . . . . .             | 149        |
|     | <b>References</b>  | <b>156</b> |
|     | <b>Bibliography</b>  | <b>156</b> |

# Acknowledgments

The completion of this thesis could not have been possible without the generous help and support of many people. First and foremost, I would like to thank my supervisor, Prof. David G. Larman whose guidance has proven invaluable. I am indebted to him for inspiring me to embark on this work, and for his patience and encouragement throughout its duration.

I am grateful to the other staff and graduate students of the Department of Mathematics at University College London for their friendship and support. In particular, I would like to thank Helen Higgins for her encouragement and friendship during some very difficult times. Also the late Professor C.A. Rogers for his very helpful guidance on a particular problem, and Dr. Maria Prodromou who helped me with the figures.

My grateful thanks go to my parents, Sedat and Sevim Sezgin and my beloved sisters, Semra, Serpil and Suzan for their generous financial support and enduring love and patience during the course of this work. I would like to dedicate this thesis to my family.

I would like to thank my husband, Cem, who was already extremely busy with his own Ph.D. There are no words to express the gratitude I feel for his constant support, understanding and patience, which has enabled me to see this study through to the end. Lastly, I would like to thank my son, Bera who was always there with me for this prolonged journey.

# Definitions and Notation

|                    |   |
|--------------------|---|
| $\mathbb{R}^n$     | $n$ -dimensional Euclidean space                              |
| $B(K)$             | blocking number   |
| $B'_\alpha(K)$     | generalized blocking number                                   |
| $B_\alpha(K)$      | unrestricted blocking number                                  |
| int                | interior  |
| $\partial K$       | the boundary of $K$ ; i.e. $\text{cl}K \setminus \text{int}K$ |
| $\ \cdot\ $        | Euclidean norm  |
| conv               | convex hull   |
| $\mathcal{B}^n$    | $n$ -ball   |
| $I_n$              | $n$ -dimensional parallelotope                                |
| $\mathfrak{B}_p^n$ | $n$ -dimensional unit $\ell_p$ ball                           |
| Per( $K$ )         | perimeter of set $K$  |



# Introduction

*The Blocking Number* exhibits a particularly simple structure. The associated problems of blocking number, like many problems of Convex and Discrete Geometry, can be presented easily, but even in three-dimension it presents some hard problems. Nevertheless, it has very interesting applications which have received the attention of not only pure mathematicians but also physicists, chemists and botanists. We draw attention to the following question related to the blocking number which is important to physics as well as of interest itself.

*How many non-overlapping translates of an  $n$ -dimensional convex body,  $\mathcal{K}$ , are enough to block all the light rays starting from  $\mathcal{K}$ ?*

This blocking light ray problem was first introduced by C. M. Zong [1]. As mentioned above, the blocking number has important applications, and at the same time it gives rise to a wide variety of generalizations. For instance, the blocking number with smaller homothetic copies,  $\alpha\mathcal{K}$ , is called *the generalized blocking number*. The generalized blocking number also has very natural generalizations itself; such as *the unrestricted blocking number*; *the generalized blocking number with negative copies*,  $-\alpha\mathcal{K}$ , and even the generalized blocking number with rotations,  $\alpha\mathcal{K}+\theta$  which is also called *the protecting number*.

The main purpose of this thesis is to study the unrestricted blocking number, which will be denoted by  $B_\alpha(\mathcal{K})$ . Section 1.1 is introductory; we give the definitions of the blocking numbers mentioned above.

In Section 1.2, we describe the results.

In Section 1.3, we prove that for a sequence of convex bodies,  $\mathcal{K}_n \mapsto \mathcal{K}$ ,

$$\limsup B_\alpha(\mathcal{K}_n) \leq B_\alpha(\mathcal{K}).$$

It is known that when  $\mathcal{K}$  is a cube with the vertices cut off we have  $B_1(\mathcal{K}) \leq 2^n$ . We also know that  $B_1(\mathcal{K}) = 2^n$  when  $\mathcal{K}$  is the  $n$ -dimensional cube. These support the following conjecture for the unrestricted blocking number with  $\alpha = 1$ , satisfies  $2n \leq B_1(\cdot) \leq 2^n$ .

In the Section 1.3, we show  $B_1(\mathfrak{B}_1) = 6$  when  $\mathfrak{B}_1$  is an octahedron in theorem 1.2. Furthermore; for the unit  $\ell_p$ -ball,  $\mathfrak{B}_p$  in  $\mathbb{R}^3$ , we have  $B_1(\mathfrak{B}_p) \leq 6$  ( $1 \leq p < \infty$ ) and  $B_1(\mathfrak{B}_\infty) = 8$ .

In Section 1.4, we also show that for the unrestricted blocking number when  $\alpha = 1$ , we have the following lower bound for centrally symmetric convex body,  $\mathcal{C}$ , in  $n$ -dimensions:

$$B_1(\mathcal{C}) \geq \frac{1}{n^{\frac{3}{2}}} (1 - m(\mathcal{C}))^{2-n}$$

where  $m(\cdot)$  is the  $M$  - curvature.

We also have that  $B_\alpha(I_n) = B'_\alpha(I_n)$  for the  $n$ -dimensional parallelotope,  $I_n$ .

A very useful property of the blocking number is that for a convex body,  $\mathcal{K}$ , it is equal to the blocking number of the difference body,  $D\mathcal{K}$ , of  $\mathcal{K}$ . However, for the unrestricted blocking number, in Section 1.5, we have examples where  $B_\alpha(\mathcal{K})$  can be smaller or larger than  $B_\alpha(D\mathcal{K})$ .

We have for the Reuleaux triangle,  $\mathcal{T}$ , and Reuleaux polygon,  $\mathcal{P}$ ,

$$(i) \quad B_{\alpha_k}(\mathcal{P}) > B_{\alpha_k}(D\mathcal{P}) = k \quad \text{where } k = 5, 7, 9, \dots$$

while

$$(ii) \quad B_{\alpha_l}(\mathcal{T}) < B_{\alpha_l}(D\mathcal{T}) = l \quad \text{where } l = 6, 9, 12, \dots$$

In section 1.5, we also consider the Newton Number and note that  $N(\mathcal{K}) = N(D\mathcal{K})$ . Here we define the Generalized Newton Number and get an example where the Generalized Newton Number,  $N_\alpha(\mathcal{K})$ , of  $\mathcal{K}$  is different from the Generalized Newton Number,  $N_\alpha(D\mathcal{K})$ , of the difference body of  $\mathcal{K}$ .

In Section 1.6, we give lower and upper bounds for the unrestricted blocking number of the  $n$ -dimensional ball.

The application of the unrestricted blocking number gives a very interesting meaning to it. In Section 1.7 we give an example. Here for example for given unrestricted blocking number,  $B_\alpha(B^3) = 6$ , we have the radius of the translates of  $B^3$ ,  $\alpha$ ,  $0.850\,826 \leq \alpha < 1.108\,508$ . So when the radius of the translates is between these numbers we always have  $B_\alpha(B^3) = 6$ .

In Section 1.8, we define the blocking number with negative translates,  $B_-(\cdot)$ . We have  $3 \leq B_-(\mathcal{K}) \leq 4$  in 2-dimension. For  $\mathcal{K}$  in  $n$ -dimension  $n \geq 3$ , we have

$$n + 1 \leq B_-(\mathcal{K}).$$

# Chapter 1

# The Unrestricted Blocking Number

## 1.1 Introduction

First of all, we give the definition of blocking.

Let  $\mathcal{K}$  be a convex body in  $\mathbb{R}^n$ . We say that a set of translates  $\{\mathcal{K} + \underline{u}_i\}_{i=1}^p$  *block*  $\mathcal{K}$  if any other translate of  $\mathcal{K}$  which touches  $\mathcal{K}$ , overlaps at least one of  $\mathcal{K} + \underline{u}_i$ ,  $i = 1, \dots, p$ .

Now we give the definitions of generalized blocking number and unrestricted blocking number.

Given a convex body  $\mathcal{K} \in \mathbb{R}^n$ , and  $\alpha > 0$ , we say that  $\{u_1, \dots, u_p\}$  is a generalized blocking set for  $\mathcal{K}$  if the following conditions hold:

$$\left\{ \begin{array}{l} (i) \quad (\alpha\mathcal{K} + u_i) \cap \mathcal{K} \neq \emptyset \quad \forall i \\ (ii) \quad \text{int}(\alpha\mathcal{K} + u_i) \cap \mathcal{K} = \emptyset \quad \forall i \\ (iii) \quad \text{int}(\alpha\mathcal{K} + u_i) \cap \text{int}(\alpha\mathcal{K} + u_j) = \emptyset \quad \forall i \neq j \\ (iv) \quad \text{If } u \in \mathbb{R}^n - \{u_1, \dots, u_p\} \text{ and } (\alpha\mathcal{K} + u) \cap \mathcal{K} \neq \emptyset \text{ and } \text{int}(\alpha\mathcal{K} + u) \cap \mathcal{K} = \emptyset \\ \quad \text{then } \exists 1 \leq i \leq p \text{ such that } \text{int}(\alpha\mathcal{K} + u) \cap \text{int}(\alpha\mathcal{K} + u_i) \neq \emptyset \end{array} \right.$$

The generalized blocking number of  $\mathcal{K}$  is the size of a smallest generalized blocking set of  $\mathcal{K}$ , we denote this by  $B'_\alpha(\mathcal{K})$ .  $B'_\alpha(\mathcal{K})$  was first investigated by K. Böröczky Jr., D. G. Larman, S. Sezgin, C. M. Zong [2].

Let  $B_\alpha(\mathcal{K})$  be the similar number to  $B'_\alpha(\mathcal{K})$  without some restrictions, i.e. the translates of  $\alpha\mathcal{K}$  are allowed to overlap and are not necessarily in contact with  $\mathcal{K}$  but they are not allowed to meet  $\text{int} \mathcal{K}$ . We call this number *the unrestricted blocking number*.

Given a convex body  $\mathcal{K} \in \mathbb{R}^n$ , and  $\alpha > 0$ , we say that  $\{u_1, \dots, u_p\}$  is an unrestricted blocking set for  $\mathcal{K}$  if the following conditions hold:

$$\left\{ \begin{array}{l} (i) \quad \text{int}(\alpha\mathcal{K} + u_i) \cap \mathcal{K} = \emptyset \quad \forall i \\ (ii) \quad \text{If } u \in \mathbb{R}^n - \{u_1, \dots, u_p\} \text{ and } (\alpha\mathcal{K} + u) \cap \mathcal{K} \neq \emptyset \text{ and } \text{int}(\alpha\mathcal{K} + u) \cap \mathcal{K} = \emptyset \\ \quad \text{then } \exists 1 \leq i \leq p \text{ such that } \text{int}(\alpha\mathcal{K} + u) \cap (\alpha\mathcal{K} + u_i) \neq \emptyset \end{array} \right.$$

The unrestricted blocking number, denoted by  $B_\alpha(\mathcal{K})$ , is the size of the smallest unrestricted blocking set. Note that it is possible  $B_\alpha(\mathcal{K})$  be achieved by translates meeting  $\mathcal{K}$  and disjoint from each other.

## 1.2 Principal Results

For the generalized blocking number, there is a well-known conjecture that for any 3-dimensional convex body  $\mathcal{K}$ , we have  $6 \leq B'_1(\cdot) \leq 8$ . In Section 1.3, we give a general result for a sequence of convex bodies. Let  $\mathcal{K}$  be a convex body in  $\mathbb{R}^d$  and  $\mathcal{K}_n$  be a sequence of convex bodies such that  $\mathcal{K}_n \mapsto \mathcal{K}$ . Then

$$\limsup B_\alpha(\mathcal{K}_n) \leq B_\alpha(\mathcal{K}).$$

From Lemma 1.3.1, we know that if  $0 < \gamma < \alpha$  then  $B_\alpha(\mathcal{K}) \leq B_\gamma(\mathcal{K})$ . With aid of this lemma, we prove the above statement.

Then we prove the conjecture for a special class of convex bodies,  $\ell_p$  balls:

$$B_1(\mathfrak{B}_p) \leq 6$$

where  $1 \leq p < \infty$ . By using a similar blocking set to the blocking set of the octahedron, we generalize this result to  $\ell_p$  balls.

In Section 1.4, we show that the unrestricted blocking number has similarities with the generalized blocking number. For the unrestricted blocking number when  $\alpha = 1$ , we have the following lower bound for  $n$ -dimensional convex body  $\mathcal{C}$  as proven for  $B_1(\mathcal{C})$  by L. Dalla, D. G. Larman, P. Mani-Levitska and C. Zong in [4]

$$B_1(\mathcal{C}) \geq \frac{1}{n^{\frac{3}{2}}} (1 - m(\mathcal{C}))^{2-n}.$$

where  $m(\mathcal{C})$  is the M-curvature.

We also have that for the  $n$ -dimensional parallelotope,  $I_n$ , we have  $B_\alpha(I_n) = B'_\alpha(I_n)$ . This result is published in [2].

A very useful property of the blocking number of a convex body,  $\mathcal{K}$ , is that it is equal to the blocking number of the difference body,  $D\mathcal{K}$ , of  $\mathcal{K}$ . However, for the unrestricted blocking number, we have some examples in Section 1.5 which show that  $B_\alpha(\mathcal{K})$  can be smaller or larger than  $B_\alpha(D\mathcal{K})$ . We have for Reuleaux triangle,  $\mathcal{T}$ , and Reuleaux polygon,  $\mathcal{P}$ ,

$$(i) \quad B_{\alpha_k}(\mathcal{P}) > B_{\alpha_k}(D\mathcal{P}) = k \quad \text{where } k = 5, 7, 9, \dots$$

whilst

$$(ii) \quad B_{\alpha_l}(\mathcal{T}) < B_{\alpha_l}(D\mathcal{T}) = l \quad \text{where } l = 6, 9, 12, \dots$$

In Section 1.5, we also define the Generalized Newton Number and obtain an example where the Generalized Newton Number of  $\mathcal{K}$ ,  $N_\alpha(\mathcal{K})$ , is different from the Generalized Newton Number of the difference body of  $\mathcal{K}$ ,  $N_\alpha(D\mathcal{K})$ . Let  $\mathcal{P}$  be any Reuleaux Polygon in  $\mathbb{R}^2$  with  $h$  vertices where  $h \geq 7$  is an odd number. Let  $\alpha_h$  be the scaling factor of the homothetic copy of  $D\mathcal{P}$ , then

$$(i) \quad N_{\alpha_k}(\mathcal{P}) > N_{\alpha_k}(D\mathcal{P}) = k \quad \text{where } \alpha_k = \frac{\sin \frac{\pi}{k}}{1 - \sin \frac{\pi}{k}} + \epsilon_k \quad (\epsilon_k > 0 \text{ and } h = k)$$

$$(ii) \quad N_{\alpha_l}(\mathcal{P}) < N_{\alpha_l}(D\mathcal{P}) = l \quad \text{where } \alpha_l = \frac{\sin \frac{\pi}{l}}{1 - \sin \frac{\pi}{l}} \quad (h = l).$$

Here  $N_{\alpha_h}(\mathcal{P})$  is the generalized Newton number with smaller copies  $\alpha_h \mathcal{P}$  of  $\mathcal{P}$ . It is in the framework of generalized kissing number that we investigate a counterexample to

$$N_{\alpha_k}(\mathcal{K}) = N_{\alpha_k}(D\mathcal{K}) \iff \mathcal{K} = \mathcal{B}$$

where  $\mathcal{K}$  is any convex body and  $\mathcal{B}$  is the unit circle. There is a convex domain  $\mathcal{K}$  with constant width 1 such that  $\mathcal{K}$  is not a circle but  $N_{\alpha_k}(\mathcal{K}) = k = N_{\alpha_k}(\mathcal{B})$  where  $\mathcal{B}$  is the unit circle. Here

$$\alpha_k = \frac{\sin \frac{\pi}{k}}{1 - \sin \frac{\pi}{k}} \quad \text{for } k = 7, 8, 9, \dots$$

is the scaling factor of homothetic copies of  $\mathcal{K}$  and  $\mathcal{B}$ .

In Section 1.6, we give lower and upper bounds for the unrestricted blocking number of  $\mathcal{B}^n$ , the  $n$ -dimensional ball with  $n \geq 9$ .

$$\begin{aligned} n^{-3/2} \left( \frac{2}{\sqrt{3}} \right)^{n-2} &\leq B_1(\mathcal{B}^n) \\ &< \frac{4\sqrt{n} \left( \frac{2}{\sqrt{3}} \right)^n}{\left( 1 - \frac{2}{\log n} \right)} \left( n \log n + n \log \log n + n \log \left( \frac{2}{\sqrt{3}} \right) + \frac{1}{2} \log 16n \right). \end{aligned}$$

The application of the unrestricted blocking number gives a very interesting meaning to the number, we use the number to show very interesting results that can be seen in nature. In Section 1.7, for given unrestricted blocking number,  $B_\alpha(\mathcal{B}^3) = k$ , the smallest radius  $\alpha$  of homothetic copies of  $\mathcal{B}^3$ ,  $\alpha\mathcal{B}^3 + x_i$ 's, where  $i = 1, \dots, k$ , will be given. For example, we see that  $B_\alpha(\mathcal{B}^3) = 6$  for  $0.850\ 826 \leq \alpha \leq 1.108\ 508$ . This theorem is based on the results of many authors as referred to in the theorem.

In Section 1.8, we define the blocking number,  $B_-(\cdot)$ , with negative translates. For any convex domain,  $\mathcal{K}$ , we prove that  $3 \leq B_-(\mathcal{K}) \leq 4$  in 2-dimensions. For any convex body  $\mathcal{K}$  in  $n$ -dimensions,  $n \geq 3$ , we have  $n + 1 \leq B_-(\mathcal{K})$ .

### 1.3 The Properties of the Unrestricted Blocking Number

In this section, we prove some fundamental theorems about the unrestricted blocking number,  $B_\alpha(\mathcal{K})$ , i.e. the smallest number of translates of  $\alpha\mathcal{K}$  are allowed to overlap and are not necessarily in contact with  $\mathcal{K}$  but they are not allowed to meet *int*  $\mathcal{K}$ .



The Hausdorff distance between two convex bodies  $\mathcal{K}_1$  and  $\mathcal{K}_2$  is at most  $\epsilon > 0$  if  $\mathcal{K}_1$  is contained in the outer parallel body  $\mathcal{K}_2 + \epsilon\mathcal{B}$  of  $\mathcal{K}_2$ , and  $\mathcal{K}_2$  is contained in the outer parallel body  $\mathcal{K}_1 + \epsilon\mathcal{B}$  of  $\mathcal{K}_1$ .

**Theorem 1.1** *Let  $\mathcal{K}$  be a convex body in  $\mathbb{R}^d$  and  $\mathcal{K}_n$  be a sequence of convex bodies such that  $\mathcal{K}_n \rightarrow \mathcal{K}$  in the Hausdorff metric. Then*

$$\limsup B_\alpha(\mathcal{K}_n) \leq B_\alpha(\mathcal{K}).$$

First, in order to prove this theorem, we require the following lemma.

**Lemma 1.3.1** *Let  $\mathcal{K}$  be a convex body in  $\mathbb{R}^d$ . If  $0 < \gamma < \alpha$  then  $B_\alpha(\mathcal{K}) \leq B_\gamma(\mathcal{K})$ .*

**Proof of 1.3.1** Let  $\alpha$  and  $\gamma$  be two different scaling factors of homothetic copies of  $\mathcal{K}$  with  $0 < \gamma < \alpha$ . Let  $\mathcal{Y} := \{\gamma\mathcal{K} + x'_i : i = 1, \dots, m\}$  be a  $\gamma$ -blocking set for  $\mathcal{K}$  and  $m = B_\gamma(\mathcal{K})$ . Let  $\{x'_i : i = 1, \dots, m\}$  be the centres of circumscribed balls of homothetic copies  $\gamma\mathcal{K} + x'_i$ 's with radius  $\gamma$ . We may suppose that the unit ball is the circumscribed ball of  $\mathcal{K}$ .

$$\text{int } \mathcal{K} \cap \text{int } (\gamma\mathcal{K} + x'_i) = \emptyset \text{ for } i = 1, \dots, m$$

If  $\mathcal{K} \cap (\gamma\mathcal{K} + x') \neq \emptyset$ , and  $\text{int } \mathcal{K} \cap \text{int } (\gamma\mathcal{K} + x') = \emptyset$ , then

$$\exists i, \quad 1 \leq i \leq m, \quad \text{such that } \text{int } (\gamma\mathcal{K} + x') \cap \text{int } (\gamma\mathcal{K} + x'_i) \neq \emptyset. \quad (1.1)$$

Here it can be assumed that  $\partial \mathcal{K} \cap \partial (\gamma\mathcal{K} + x'_i) \neq \emptyset$  for all  $i$ . Even if the homothetic copies of  $\mathcal{K}$  are placed such that they do not touch  $\mathcal{K}$ , this does not change the following proof of the lemma.

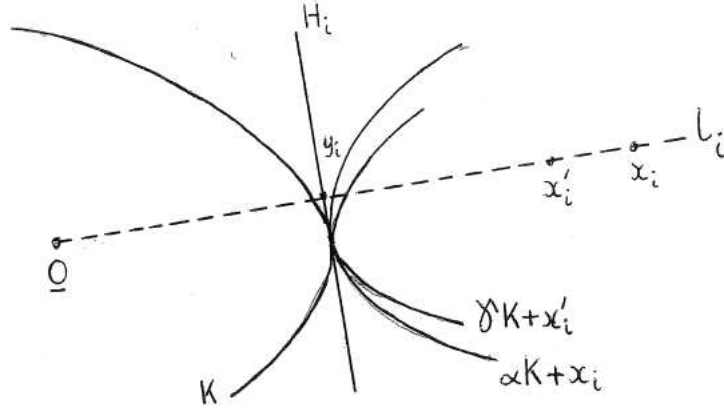

Figure 1.1.1

The proof depends on the positions of the homothetic copies relative to each other, it does not depend on whether or not they touch  $\mathcal{K}$ .

We will define another blocking arrangement of  $\mathcal{K}$  with the bigger homothetic copies. Let  $\underline{O}(x'_i)$  be the centre of the circumscribed ball of  $\mathcal{K}(\gamma\mathcal{K} + x'_i)$  respectively. Let  $l_i$  be the line passing through  $\underline{O}$  and  $x'_i$ . Let  $\mathcal{H}_i$  be a hyperplane that separates  $\mathcal{K}$  and  $\gamma\mathcal{K} + x'_i$  with property  $y_i := \mathcal{H}_i \cap l_i$ . (See Figure 1.1.1). Hence the new blocking set is  $\mathcal{X} := \{\alpha\mathcal{K} + x_i : i = 1, \dots, m\}$  where  $x_i$  is defined as follows:

$$x_i = \frac{\alpha}{\gamma} x'_i + \left(1 - \frac{\alpha}{\gamma}\right) y_i.$$

Furthermore, it satisfies  $\text{int } \mathcal{K} \cap \text{int } (\alpha\mathcal{K} + x_i) = \emptyset$  and

$$\gamma\mathcal{K} + x'_i \subset \alpha\mathcal{K} + x_i \quad \text{where } i = 1, \dots, m \quad (1.2)$$

Using these facts, we will prove that

$$B_\alpha(\mathcal{K}) \leq B_\gamma(\mathcal{K}).$$

Now we suppose that there exists one homothetic copy  $\alpha\mathcal{K} + x$  such that it touches  $\mathcal{K}$  and is disjoint from  $\alpha\mathcal{K} + x_i$  where  $i = 1, \dots, m$ , i.e.,  $\text{int}(\alpha\mathcal{K} + x) \cap (\alpha\mathcal{K} + x_i) = \emptyset$ . From (1.2), we know that there is a homothetic copy,  $\gamma\mathcal{K} + x'$  such that  $\gamma\mathcal{K} + x' \subset \alpha\mathcal{K} + x$  with the given property  $x = \frac{\alpha}{\gamma}x' + \left(1 - \frac{\alpha}{\gamma}\right)y$ . Therefore  $\gamma\mathcal{K} + x'$  is a disjoint homothetic copy other than  $\{\gamma\mathcal{K} + x'_i : i = 1, \dots, m\}$ . This is a contradiction to (1.1).

Hence  $\{\alpha\mathcal{K} + x_i\}_{i=1}^m$  is an  $\alpha$ -blocking set for  $\mathcal{K}$ . Therefore,  $B_\alpha(\mathcal{K}) \leq m = B_\gamma(\mathcal{K})$ . This concludes the proof of the lemma.  $\square$

We now prove Theorem 1.1.

**Proof of 1.1** Assume  $B_\alpha(\mathcal{K}) = p$ . We need to show that

$$\limsup B_\alpha(\mathcal{K}_n) \leq p.$$

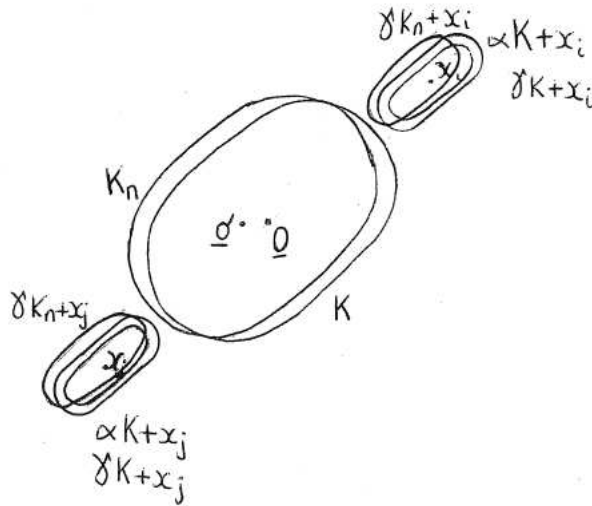

Figure 1.1.2

Let  $\{\alpha\mathcal{K} + x_i : i = 1, \dots, p\}$  be  $\alpha$ -blocking set for  $\mathcal{K}$ . Then for  $\gamma < \alpha$ , but sufficiently

close to  $\alpha$ ,  $\{\gamma\mathcal{K} + x_i : i = 1, \dots, p\}$  is a  $\gamma$ -blocking set for  $\mathcal{K}$ . The sets  $\{\gamma\mathcal{K} + x_i\}_{i=1}^p$  are pairwise disjoint and disjoint from  $\mathcal{K}$  since  $\gamma\mathcal{K} + x_i \subset \text{int}(\alpha\mathcal{K} + x_i)$ .

Let  $\mathcal{K}_n$  be a sequence of convex bodies so that  $\mathcal{K}_n$ 's are very similar to  $\mathcal{K}$ . Since  $\mathcal{K}_n$  is sufficiently close to  $\mathcal{K}$ , for  $n$  sufficiently large, we get a  $\gamma$ -blocking set for  $\mathcal{K}_n$ ,  $\{\gamma\mathcal{K}_n + x_i\}_{i=1}^p$ . Since  $\gamma\mathcal{K} + x_i$ 's are pairwise disjoint and they do not touch  $\mathcal{K}$ ; the  $\gamma\mathcal{K}_n + x_i$ 's might touch  $\mathcal{K}_n$  but they do not intersect  $\mathcal{K}_n$  and also they might overlap each other which is allowed for  $B_\gamma(\mathcal{K}_n)$ .

So for  $n$  sufficiently large,  $B_\gamma(\mathcal{K}_n) \leq p$ . From the lemma, as  $\alpha > \gamma$  and  $n$  sufficiently large,

$$B_\alpha(\mathcal{K}_n) \leq B_\gamma(\mathcal{K}_n) \leq p = B_\alpha(\mathcal{K}).$$

So

$$\limsup B_\alpha(\mathcal{K}_n) \leq p = B_\alpha(\mathcal{K}).$$

as required.  $\square$

In 1995, C.M. Zong [3], it has been proven that when  $\epsilon$  is a sufficiently small positive number,

$$\begin{aligned} \mathcal{Q} &= \{(x_1, \dots, x_n) : |x_i| \leq \frac{1}{2}, 1 \leq i \leq n\}, \\ T_{i,\epsilon} &: (x_1, \dots, x_n) \mapsto (1 - \epsilon|x_i|) \left( x_1, \dots, \frac{x_i}{1 - \epsilon|x_i|}, \dots, x_n \right) \\ T_\epsilon &= T_{1,\epsilon} T_{2,\epsilon} \cdots T_{n,\epsilon}, \end{aligned}$$

and taking  $\mathcal{Q}'_\epsilon = T_\epsilon(\mathcal{Q})$ , then we have

$$B'_1(\mathcal{Q}'_\epsilon) \leq 2n.$$

Note that in his paper  $B'_\alpha(Q'_\epsilon) \leq 2n$  has been proven where  $B'_1(Q'_\epsilon)$  is the generalized blocking number. As can be seen from the proof of lemma 2 in [3], the translates of  $Q'_\epsilon$  do not have to touch  $Q'_\epsilon$  and they can be chosen as overlapping each other. So the same proof applies for the unrestricted blocking number,

$$B_1(Q'_\epsilon) \leq 2n.$$

We know that  $Q'_\epsilon \mapsto Q$  where  $Q$  is the unit cube and  $Q'_\epsilon$  is the centrally symmetric convex body described above. Namely,  $B_1(Q'_\epsilon) \leq 2n \leq 2^n = B_1(Q)$ . From Theorem 1.1, we also have the following result,

$$\limsup B_1(Q') \leq B_1(Q)$$

where equality holds only for  $n = 2$ .

As another example, we take the unit  $\ell_p$  balls into consideration since they not only satisfy Theorem 1.1, but they also include crosspolytope, ball and cube which are interesting examples to investigate.

Namely, as above,  $\limsup B_\alpha(K_n) \leq B_\alpha(K)$  is proved, we have

$$\limsup B_1(\mathfrak{B}_p) \leq B_1(\mathcal{W}) = 8$$

holds where  $\mathfrak{B}_p$  is the unit  $\ell_p$  ball and  $\mathcal{W}$  is the unit cube in  $\mathbb{R}^3$ .

In Theorem 1.2, we will prove that for any  $\ell_p$  ball,  $\mathfrak{B}_p$ , the unrestricted blocking number is less than or equal to 6,  $B_1(\mathfrak{B}_p) \leq 6$ . We also include the result for octahedron,  $B_1(\mathfrak{B}_1) = 6$  in this theorem.

**Theorem 1.2** *Let  $\mathfrak{B}_p$  be the unit  $\ell_p$  ball in  $\mathbb{R}^3$ . Then*

$$B_1(\mathfrak{B}_p) \leq 6$$

*holds where  $1 \leq p < \infty$ .*

**Proof of 1.2** The proof consists of several parts. First we will take the unit  $\ell_p$  ball  $\mathfrak{B}_p$  when  $p > \frac{\log 3}{\log 2}$ , and prove that  $B_1(\mathfrak{B}_p)$  is at most 6. Let  $e_i$  be the  $i^{\text{th}}$  unit vector in  $\mathbb{R}^3$ . Let  $\{\mp 2e_i : i = 1, 2, 3\}$  be the centres of translated copies,  $\mathfrak{B}_p \mp 2e_i$ 's. We shall show that  $\mathcal{X} := \{\mathfrak{B}_p \mp 2e_i : i = 1, 2, 3\}$  is a blocking set for  $\mathfrak{B}_p$ , i.e.,

$$\text{int } \mathfrak{B}_p \cap \text{int } (\mathfrak{B}_p \mp 2e_i) = \emptyset \text{ for } i = 1, 2, 3$$

If  $\mathfrak{B}_p \cap (\mathfrak{B}_p + x) \neq \emptyset$  and  $\text{int } \mathfrak{B}_p \cap \text{int } (\mathfrak{B}_p + x) = \emptyset$ , then

$$\exists i, \quad 1 \leq i \leq 3, \quad \text{such that } \text{int } (\mathfrak{B}_p + x) \cap \text{int } (\mathfrak{B}_p \mp 2e_i) \neq \emptyset.$$

We also know that since  $\mathfrak{B}_p$  is centrally symmetric convex body, in order to prove  $B_1(\mathfrak{B}_p) \leq 6$ , it is sufficient to show that:

$$\partial (2\mathfrak{B}_p) \subset \bigcup_{i=1}^3 \text{int } (2\mathfrak{B}_p \mp 2e_i).$$

We suppose not i.e. there exists  $x = (x_1, x_2, x_3) \in \partial (2\mathfrak{B}_p)$  but  $x \notin \text{int } (2\mathfrak{B}_p \mp 2e_i)$  for any  $i = 1, 2, 3$ . We have

$$x_1^p + x_2^p + x_3^p = 2^p \tag{1.3}$$

and, by symmetry, we may assume  $x_1, x_2, x_3 \geq 0$ .

Since it is also supposed that  $x \notin \text{int } (2\mathfrak{B}_p \mp 2e_i)$ ,  $x$  is at distance at least 2 from each of the vectors  $2e_i$ , i.e.,  $\mp(2, 0, 0), \mp(0, 2, 0), \mp(0, 0, 2)$ . Therefore;

$$\begin{aligned} |x_1 - 2|^p + x_2^p + x_3^p &\geq 2^p \\ x_1^p + |x_2 - 2|^p + x_3^p &\geq 2^p \\ x_1^p + x_2^p + |x_3 - 2|^p &\geq 2^p \end{aligned} \tag{1.4}$$

From (1.3) and (1.4), we have

$$\begin{aligned} x_3^p = 2^p - (x_1^p + x_2^p) \quad \text{and} \quad |x_3 - 2|^p &\geq 2^p - (x_1^p + x_2^p) \\ \implies |x_3 - 2|^p &\geq x_3^p. \end{aligned} \quad (1.5)$$

Since we know that  $x \in \partial(2\mathfrak{B}_p)$ ,  $x_i^p \geq \frac{2^p}{3}$  holds for at least one  $i$ , where  $i = 1, 2$  or  $3$ , say  $x_3$ . So we may assume  $x_3^p \geq \frac{2^p}{3}$  i.e.,  $x_3 \geq \frac{2}{3^{1/p}}$ .

By using these statements, we will prove that our assumption,  $x \notin \text{int}(2\mathfrak{B}_p \mp 2e_i)$ , is false. From the above statement and (1.5) together with the fact that  $x_3 \leq 2$ , we have

$$\begin{aligned} (2 - x_3)^p &\geq x_3^p \\ \left(2 - \frac{2}{3^{1/p}}\right)^p &\geq (2 - x_3)^p \geq x_3^p \geq \frac{2^p}{3} \\ \left(1 - \frac{1}{3^{1/p}}\right)^p &\geq \frac{1}{3} \\ 1 - \frac{1}{3^{1/p}} &\geq \frac{1}{3^{1/p}} \\ 1 &\geq \frac{2}{3^{1/p}} \\ 3^{1/p} &\geq 2 \\ \frac{1}{p} \log 3 &\geq \log 2 \\ \frac{\log 3}{\log 2} &\geq p. \end{aligned}$$

This is a contradiction as  $p > \frac{\log 3}{\log 2}$ . So if  $\frac{\log 3}{\log 2} < p < \infty$ , we have proved the required

result that  $x$  is covered by one of the translates  $\{2\mathfrak{B}_p \mp 2e_i\}$ . Briefly,

$$B_1(\mathfrak{B}_p) \leq 6 \quad \text{holds for} \quad \frac{\log 3}{\log 2} < p < \infty. \quad (1.6)$$

It is worth noticing that for  $p = \infty$ ,  $\mathfrak{B}_p$  is the unit cube and in  $\mathbb{R}^3$ ,  $B_1(\mathfrak{B}_\infty) = 8$  was proved by L. Dalla, D. G. Larman, P. Mani-Levitska and C. Zong [4]. (See Figure 1.3.1).

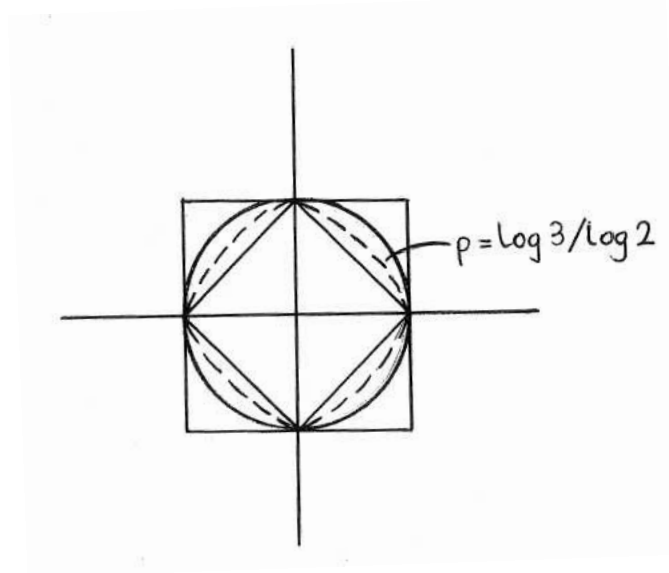

Figure 1.3.1

Although the special case  $p = 2$  is included in the general case above, we want to show that we can use a different blocking set to prove this special case. This blocking set, together with that for  $p = 1$ , will give us an indication of the blocking set to be chosen for general  $p$ ,  $1 \leq p \leq 2$ . Here we should also emphasize that when  $p = 2$ ,  $\mathfrak{B}_p$  is the unit ball and  $B_1(\mathfrak{B}_2) = 6$  as proved by L. Dalla, D. G. Larman, P. Mani-Levitska and C. Zong [4].

For  $p = 2$ , we consider the points  $\{\mp \lambda a, \mp \lambda b, \mp \lambda c\}$  with  $\lambda = \frac{2\sqrt{2}}{\sqrt{3}}$  chosen so



that the points are on the  $\partial(2\mathfrak{B}_2)$ .

Now we take  $\lambda a = \left(\lambda, \frac{\lambda}{2}, \frac{\lambda}{2}\right)$  and find for which  $\lambda$  the distance between  $\underline{Q}$  and  $\lambda a$  is 2.

$$\begin{aligned}\sqrt{\lambda^2 + \frac{\lambda^2}{4} + \frac{\lambda^2}{4}} &= 2 \\ \sqrt{\frac{6}{4}} \lambda &= 2 \\ \lambda &= 2\sqrt{\frac{2}{3}}.\end{aligned}$$

Let  $x$  be a point of  $\partial(2\mathfrak{B}_2)$  which maximizes the minimum distance from  $\lambda a$ ,  $\lambda b$ ,  $\lambda c$  and the ray,  $\overrightarrow{Ox}$ , determined by  $x$  lies in the cone generated by  $\underline{Q}$ ,  $a$ ,  $b$ ,  $c$ . (See figure 1.2.2).

We define  $x$  equidistant from  $\lambda a$ ,  $\lambda b$ ,  $\lambda c$ , i.e.,  $|\lambda a - x| = |\lambda b - x| = |\lambda c - x|$  where

$$|\lambda a - x| = \sqrt{(\lambda - x_1)^2 + \left(\frac{\lambda}{2} - x_2\right)^2 + \left(\frac{\lambda}{2} - x_3\right)^2}.$$

Then

$$|\lambda a - x|^2 = |\lambda b - x|^2 = |\lambda c - x|^2$$

$$\begin{aligned}(\lambda - x_1)^2 + \left(\frac{\lambda}{2} - x_2\right)^2 + \left(\frac{\lambda}{2} - x_3\right)^2 &= \left(\frac{\lambda}{2} + x_1\right)^2 + \left(\frac{\lambda}{2} - x_2\right)^2 + (\lambda - x_3)^2 \\ &= \left(\frac{\lambda}{2} + x_1\right)^2 + (\lambda - x_2)^2 + \left(\frac{\lambda}{2} + x_3\right)^2.\end{aligned}$$

If we take the first equality, we have

$$(\lambda - x_1)^2 + \left(\frac{\lambda}{2} - x_3\right)^2 = \left(\frac{\lambda}{2} + x_1\right)^2 + (\lambda - x_3)^2$$

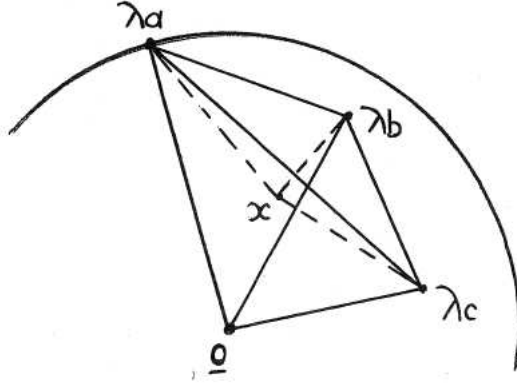

Figure 1.2.2

$$\lambda^2 - 2\lambda x_1 + x_1^2 + \frac{\lambda^2}{4} - \lambda x_3 + x_3^2 = \frac{\lambda^2}{4} + \lambda x_1 + x_1^2 + \lambda^2 - 2\lambda x_3 + x_3^2$$

$$\lambda x_3 = 3 \lambda x_1$$

$$x_3 = 3 x_1$$

If we consider the last equality, we have

$$\left(\frac{\lambda}{2} - x_2\right)^2 + (\lambda - x_3)^2 = (\lambda - x_2)^2 + \left(\frac{\lambda}{2} + x_3\right)^2$$

$$\frac{\lambda^2}{4} - \lambda x_2 + x_2^2 + \lambda^2 - 2\lambda x_3 + x_3^2 = \lambda^2 - 2\lambda x_2 + x_2^2 + \frac{\lambda^2}{4} + \lambda x_3 + x_3^2$$

$$\lambda x_2 = 3 \lambda x_3$$

$$x_2 = 3 x_3$$

So we have  $x_2 = 3x_3 = 9x_1$ . We also know that  $x \in \partial(2\mathfrak{B}_2)$ , so  $x_1^2 + x_2^2 + x_3^2 = 4$ , i.e.,  $x_1^2(1 + 9 + 81) = 4$ . As a result we have  $x_1 = \frac{2}{\sqrt{91}}$ .

So if at least one of  $|\lambda a - x| < 2$ ,  $|\lambda b - x| < 2$ ,  $|\lambda c - x| < 2$  holds, this will mean that  $x$  is covered.

$$\begin{aligned} |\lambda a - x|^2 &= (\lambda - x_1)^2 + \left(\frac{\lambda}{2} + x_2\right)^2 + \left(\frac{\lambda}{2} + x_3\right)^2 \\ &= \lambda^2 - 2\lambda x_1 + x_1^2 + \frac{\lambda^2}{2} - \lambda x_2 + x_2^2 + \frac{\lambda^2}{4} - \lambda x_3 + x_3^2 \\ &= \frac{3}{2}\lambda^2 + 4 - 14\lambda x_1 \end{aligned}$$

Since  $\lambda = 2\sqrt{\frac{2}{3}}$  and  $x_1 = \frac{2}{\sqrt{91}}$ , we have

$$\begin{aligned} |\lambda a - x|^2 &= \frac{3}{2} \cdot \frac{8}{3} + 4 - 14 \cdot 2\sqrt{\frac{2}{3}} \cdot \frac{2}{\sqrt{91}} = 3.2068 \\ |\lambda a - x|^2 &< 2^2 \\ |\lambda a - x| &< 2 \end{aligned}$$

This means that we have  $\{\mathfrak{B}_2 \mp \lambda a, \mathfrak{B}_2 \mp \lambda b, \mathfrak{B}_2 \mp \lambda c\}$  with  $\lambda = 2\sqrt{\frac{2}{3}}$  as the blocking set for  $\mathfrak{B}_2$  and then we have  $B_1(\mathfrak{B}_2) \leq 6$ .

We now begin the proof in the general case  $1 \leq p \leq \frac{\log 3}{\log 2}$ . By generalizing the blocking set of  $\mathfrak{B}_1$ , we will prove  $B_1(\mathfrak{B}_p) \leq 6$  for  $1 \leq p \leq \frac{\log 3}{\log 2}$ . We will get the blocking set for  $\mathfrak{B}_p$  by generalizing the points used in the proof for  $p = 1$ :

$$a = \left(1, \frac{1}{2}, \frac{1}{2}\right), \quad b = \left(-\frac{1}{2}, 1, -\frac{1}{2}\right), \quad c = \left(-\frac{1}{2}, \frac{1}{2}, 1\right).$$

We shall show that the following blocking set will apply to any  $\ell_p$  ball,  $\mathfrak{B}_p$  when  $1 \leq p \leq \frac{\log 3}{\log 2}$ :

$$\mathfrak{A} := \{\mathfrak{B}_p \mp a, \mathfrak{B}_p \mp b, \mathfrak{B}_p \mp c\}$$

where

$$a = (x, y, y), \quad b = (-y, x, -y), \quad c = (-y, y, x)$$

where  $\frac{1}{2} \leq y = 2^{-1/p} \leq 2.4^{-1/p}$  and  $x = (2^p - 1)^{1/p} \geq 2.2^{-1/p} \geq 1$ . Here  $\|a\|_p = \|b\|_p = \|c\|_p = 2$ .

Now we need to show that any point  $\underline{x} = (x_1, x_2, x_3)$  where  $\|\underline{x}\|_p = 2$ , is within distance 2 of at least one of  $\{\mp a, \mp b, \mp c\}$ . Before considering the cases, we give a lemma which we use throughout the proof.

**Lemma 1.3.2** *If  $a_1, \dots, a_n \geq 0$  and  $1 \leq p \leq 2$ , then  $a_1^p + \dots + a_n^p \leq (a_1 + \dots + a_n)^p$ .*

The proof of this lemma is elementary.

Now we have the following cases to prove the “facet” for  $\ell_p$  balls, determined by  $(2, 0, 0)$ ,  $(0, 2, 0)$ ,  $(0, 0, 2)$ , is covered by the blocking set. Here the “facet” is the region of the  $\ell_p$  ball boundary determined by the cone, apex  $\underline{0}$ , generated by  $(2, 0, 0)$ ,  $(0, 2, 0)$ ,  $(0, 0, 2)$ . Note that case 1.1 and case 1.2 cover when  $x_1 > x$ . Similarly, case 1.3 and case 1.4 cover when  $x_2 > x$  and finally, case 1.5 and case 1.6 cover when  $x_3 > x$ . We should also emphasize that the “facet”  $(-2, 0, 0)$ ,  $(0, -2, 0)$ ,  $(0, 0, -2)$  is similarly covered because of symmetry, i.e., the cases where  $x_1 < x$ ,  $x_2 < x$  and  $x_3 < x$  can be proven similarly.

- **Case 1.1.**  $x_1, x_2, x_3 \geq 0$  and  $x_1 > x$ ,  $x_2 < y$ ,  $x_3 < y$ .

Note that the possibility  $x_1 > x$ ,  $x_2 > y$ ,  $x_3 > y$  can not rise

since  $x_1^p + x_2^p + x_3^p = 2y^p + x^p = 2^p$ .

- **Case 1.2.**  $x_1, x_2, x_3 \geq 0$  and  $x_1 > x$ ,  $x_2 > y$ ,  $x_3 < y$ .

In this case, we also cover the case  $x_1 > x$ ,  $x_2 < y$ ,  $x_3 > y$ .

The proof of this case is a repetition of proof of case 1.2.

- **Case 1.3.**  $x_1, x_2, x_3 \geq 0$  and  $x_2 > x$ ,  $x_1 < y$ ,  $x_3 < y$ .

Note that the possibility  $x_2 > x$ ,  $x_1 > y$ ,  $x_3 > y$  can not rise

since  $x_1^p + x_2^p + x_3^p = 2y^p + x^p = 2^p$ .

- **Case 1.4.**  $x_1, x_2, x_3 \geq 0$  and  $x_2 > x, x_1 > y, x_3 < y$ .

In this case, we also cover the case  $x_2 > x, x_1 < y, x_3 > y$ .

The proof of this case is a repetition of proof of case 1.4.

- **Case 1.5.**  $x_1, x_2, x_3 \geq 0$  and  $x_3 > x, x_1 < y, x_2 < y$ .

Note that the possibility  $x_3 > x, x_1 > y, x_2 > y$  can not rise

since  $x_1^p + x_2^p + x_3^p = 2y^p + x^p = 2^p$ .

- **Case 1.6.**  $x_1, x_2, x_3 \geq 0$  and  $x_3 > x, x_1 > y, x_2 < y$ .

In this case, we also cover the case  $x_3 > x, x_1 < y, x_2 > y$ .

The proof of this case is a repetition of proof of case 1.6.

Secondly, we have the following cases to prove the “facet” for  $\ell_p$  balls, determined by  $(2, 0, 0), (0, -2, 0), (0, 0, 2)$ , is covered by the blocking set. Again note that because of symmetry, the facet  $(-2, 0, 0), (0, 2, 0), (0, 0, -2)$ , is similarly covered. Note that there is no case for  $x_2 > x > 1$  since  $x_2 \leq 0$ . We only consider  $x_1 > x$  and  $x_3 > x$  respectively.

- **Case 2.1.**  $x_1, x_3 \geq 0, x_2 \leq 0$  and  $x_1 > x, x_2 > -y, x_3 > y$ .

In this case, we also cover the case  $x_1 > x, x_2 < -y, x_3 < y$ .

- **Case 2.2.**  $x_1, x_3 \geq 0, x_2 \leq 0$  and  $x_1 > x, x_2 > -y, x_3 < y$ .

Note that the possibility  $x_1 > x, x_2 < -y, x_3 > y$  can not rise

since  $x_1^p + (-x_2)^p + x_3^p > x^p + 2y^p > 2^p$ .

- **Case 2.3.**  $x_1, x_3 \geq 0, x_2 \leq 0$  and  $x_3 > x, x_1 > y, x_2 > -y$ .

In this case, we also cover the case  $x_3 > x, x_1 < y, x_2 < -y$ .

The proof of this case is a repetition of proof of case 2.3.

- **Case 2.4.**  $x_1, x_3 \geq 0, x_2 \leq 0$  and  $x_3 > x, x_1 < y, x_2 > -y$ .

Note that the possibility  $x_3 > x, x_1 > y, x_2 < -y$  can not rise

since  $x_1^p + (-x_2)^p + x_3^p > 2^p$ .

Thirdly, we have the following cases to prove the facet for  $\ell_p$  balls determined by  $(-2, 0, 0), (0, 2, 0), (0, 0, 2)$  is covered by the blocking set. Because of symmetry, the facet  $(2, 0, 0), (0, -2, 0), (0, 0, -2)$ , is similarly covered. Note that for this “facet”, we have  $x_1 \leq 0$ , so we omit the case  $x_1 > x > 1$ . We only consider  $x_2 > x$  and  $x_3 > x$  respectively.

- **Case 3.1.**  $x_1 \leq 0, x_2, x_3 \geq 0$  and  $x_2 > x, x_1 < -y, x_3 < y$ .

In this case, we also cover the case  $x_2 > x, x_1 > -y, x_3 > y$ .

- **Case 3.2.**  $x_1 \leq 0, x_2, x_3 \geq 0$  and  $x_2 > x, x_1 > -y, x_3 < y$ .

Note that the possibility  $x_2 > x, x_1 < -y, x_3 > y$  can not rise

since  $(-x_1)^p + x_2^p + x_3^p > 2^p$ .

- **Case 3.3.**  $x_1 \leq 0, x_2, x_3 \geq 0$  and  $x_3 > x, x_1 < -y, x_2 < y$ .

In this case, we also cover the case  $x_3 > x, x_1 > -y, x_2 > y$ .

- **Case 3.4.**  $x_1 \leq 0, x_2, x_3 \geq 0$  and  $x_3 > x, x_1 > -y, x_2 < y$ .

Note that the possibility  $x_3 > x, x_1 < -y, x_2 > y$  can not rise

since  $(-x_1)^p + x_2^p + x_3^p > 2^p$ .

Lastly, we have the following cases to prove the facet for  $\ell_p$  balls determined by  $(2, 0, 0), (0, 2, 0), (0, 0, -2)$  is covered by the blocking set. Because of symmetry, the

facet  $(-2, 0, 0)$ ,  $(0, -2, 0)$ ,  $(0, 0, 2)$ , is similarly covered. Note that for this facet, we have  $x_3 < 0$ , so we omit the case  $x_3 > x > 1$ . We only consider  $x_1 > x$  and  $x_2 > x$  respectively.

- **Case 4.1.**  $x_1, x_2 \geq 0$ ,  $x_3 \leq 0$  and  $x_1 > x$ ,  $x_2 < y$ ,  $x_3 < -y$ .

In this case, we also cover the case  $x_1 > x$ ,  $x_2 > y$ ,  $x_3 > -y$ .

- **Case 4.2.**  $x_1, x_2 \geq 0$ ,  $x_3 \leq 0$  and  $x_1 > x$ ,  $x_2 < y$ ,  $x_3 > -y$ .

Note that the possibility  $x_1 > x$ ,  $x_2 > y$ ,  $x_3 < -y$  can not rise

since  $x_1^p + x_2^p + (-x_3)^p > x^p + 2y^p > 2^p$ .

- **Case 4.3.**  $x_1, x_2 \geq 0$ ,  $x_3 \leq 0$  and  $x_2 > x$ ,  $x_1 < y$ ,  $x_3 < -y$ .

In this case, we also cover the case  $x_2 > x$ ,  $x_1 > y$ ,  $x_3 > -y$ .

- **Case 4.4.**  $x_1, x_2 \geq 0$ ,  $x_3 \leq 0$  and  $x_2 > x$ ,  $x_1 < y$ ,  $x_3 > -y$ .

Note that the possibility  $x_2 > x$ ,  $x_1 > y$ ,  $x_3 < -y$  can not rise

since  $x_1^p + (-x_2)^p + x_3^p > 2^p$ .

Now we prove each case:

**CASE 1.1 :**  $x_1, x_2, x_3 \geq 0$  and  $x_1 > x$ . Here we only take  $x_2 < y$  and  $x_3 < y$ .

We know that  $(x_1^p + x_2^p + x_3^p)^{1/p} = 2$  where  $\underline{x} = (x_1, x_2, x_3)$ . We also know that  $a = (x, y, y)$ . We have

$$\begin{aligned} \|a - \underline{x}\|^p &= (x_1 - x)^p + (y - x_2)^p + (y - x_3)^p \\ &\leq x^p + 2y^p \quad \text{since } x_1 - x \leq 1 \leq x \\ &\leq 2^p. \end{aligned}$$

We have  $\|a - \underline{x}\|_p \leq 2$  when  $x_1 > x$ ,  $x_2 < y$ ,  $x_3 < y$ .

**CASE 1.2 :**  $x_1, x_2, x_3 \geq 0$  and  $x_1 > x$ . First we take  $x_2 > y$  and  $x_3 < y$ .

$$\|a - \underline{x}\|^p = (x_1 - x)^p + (x_2 - y)^p + (y - x_3)^p \quad (1.7)$$

We know that  $x_1^p + x_2^p + x_3^p = 2^p$ . While  $x_1$  and  $x_2$  are increasing,  $x_3$  is decreasing. So in (1.7), the right hand side increases if we increase  $x_1$  and  $x_2$  while decreasing  $x_3$ .

$$\|a - \underline{x}\|^p \leq (x_1^* - x)^p + (x_2^* - y)^p + y^p$$

where  $(x_1^*)^p + (x_2^*)^p = 2^p$  when  $x_1^*, x_2^* \geq 0$ . By Lemma 1.3.2, we have

$$\|a - \underline{x}\|^p \leq (x_1^* + x_2^* - x)^p. \quad (1.8)$$

Now using Holder's inequality, we have

$$\begin{aligned} x_1^* + x_2^* &= 1.x_1^* + 1.x_2^* \leq 2^{1/q}.2 = 2^{1-1/p}.2 = 4.2^{-1/p} \\ \text{i.e. } x_1^* + x_2^* &\leq 4.2^{-1/p}. \end{aligned}$$

From (1.8), we need to prove that

$$(x_1^* + x_2^* - x)^p \leq 2^p.$$

Since we have  $x_1^* + x_2^* \leq 4.2^{-1/p}$ , we only need to prove that

$$x_1^* + x_2^* \leq 2 + x$$

which holds if

$$4.2^{-1/p} \leq 2 + x.$$

We know that  $x \geq 2.2^{-1/p}$ , so we only need to show that

$$\begin{aligned} 4.2^{-1/p} &\leq 2 + 2.2^{-1/p} \\ \text{i.e. } 2^{-1/p} &\leq 1 \end{aligned}$$



which holds for  $p > 0$ .

So for this case  $\|a - \underline{x}\|_p \leq 2$  holds as required.

If we take  $x_1 > x$ ,  $x_2 < y$ ,  $x_3 > y$ , we can still prove that  $\|a - \underline{x}\|_p \leq 2$ . Namely,

$$\|a - \underline{x}\|^p = (x_1 - x)^p + (y - x_2)^p + (x_3 - y)^p.$$

We repeat the above proof. So we have  $\|a - \underline{x}\|_p \leq 2$  when  $x_1 > x$ ,  $x_2 < y$ ,  $x_3 > y$ .

Briefly, case 1.1 and case 1.2 sum up that when  $x_1, x_2, x_3 \geq 0$  and  $x_1 > x$ , we have  $\|a - \underline{x}\|_p \leq 2$ .

**CASE 1.3 :**  $x_1, x_2, x_3 \geq 0$  and  $x_2 > x$ . Here we only consider  $x_1 < y$  and  $x_3 < y$ .

$$\|b - \underline{x}\|^p = (x_1 + y)^p + (x_2 - x)^p + (x_3 + y)^p$$

For  $x_1^p + x_3^p$  fixed,  $(x_1 + y)^p + (x_3 + y)^p$  takes its maximum when  $x_1 = x_3$ . To prove this statement holds, suppose  $x_1^p + x_3^p = \alpha$ . So  $x_3 = (\alpha - x_1^p)^{1/p}$ . Now we may suppose  $x_1 \geq x_3$ . Let

$$f(x_1) = (x_1 + y)^p + (x_3 + y)^p = (x_1 + y)^p + \left( (\alpha - x_1^p)^{1/p} + y \right)^p$$

$$\frac{df}{dx_1} = p(x_1 + y)^{p-1} - p \left( (\alpha - x_1^p)^{1/p} + y \right)^{p-1} \cdot \frac{1}{p} (\alpha - x_1^p)^{\frac{1}{p}-1} \cdot p x_1^{p-1}$$

$$= p(x_1 + y)^{p-1} - p(x_3 + y)^{p-1} \frac{x_3}{x_3^p} x_1^{p-1}$$

$$= p x_3^{1-p} \left( (x_1 + y)^{p-1} x_3^{p-1} - (x_3 + y)^{p-1} x_1^{p-1} \right).$$

As  $x_1 \geq x_3$ ,  $(x_3 + y)x_1 \geq (x_1 + y)x_3$  and  $p - 1 \geq 0$ . Hence we have  $\frac{df}{dx_1} \leq 0$ . So

maximum occurs when  $x_1 = x_3$ . Therefore, taking  $x_1 = x_3$

$$\begin{aligned} \|b - \underline{x}\|^p &\leq (x_1 + y)^p + (x_2 - x)^p + (x_3 + y)^p \\ \|b - \underline{x}\|^p &\leq 2(x_1 + y)^p + (x_2 - x)^p \end{aligned} \quad (1.9)$$

where  $2x_1^p + x_2^p = 2^p$ ,  $x_1 < y$ ,  $x_2 > x$ . We show that  $\|b - \underline{x}\|^p$  takes its maximum when  $x_1 = y$  and  $x_2 = x$ . We have  $2(x_1 + y)^p + (x_2 - x)^p$  with  $2x_1^p + x_2^p = 2^p$ , i.e.,  $x_2 = (2^p - 2x_1^p)^{1/p}$ . So

$$g(x_1) = 2(x_1 + y)^p + \left( (2^p - 2x_1^p)^{1/p} - x \right)^p$$

$$\frac{dg}{dx_1} = p x_2^{p-1} \left( (x_1 + y)^{p-1} x_2^{p-1} - (x_2 - x)^{p-1} x_1^{p-1} \right)$$

Now  $x_1 < y$ ,  $x_2 > x$ , so  $(x_1 + y) x_2 > (x_2 - x)x_1$ , i.e.,  $g$  is increasing with  $x_1$ ,  $\frac{dg}{dx_1} \geq 0$ . So maximum value is when  $x_1 = y$ .

Briefly, we have  $\|b - \underline{x}\|^p \leq (x_1^* + y)^p + (x_2^* - x)^p + (x_3^* + y)^p$ , where  $x_1^* = x_3^*$ ,  $x_1^* = y$  and  $x_2^* = x$ . So as in (1.9),

$$\begin{aligned} \|b - \underline{x}\|^p &\leq 2(x_1^* + y)^p + (x_2^* - x)^p \\ &= 2(2y)^p. \end{aligned}$$

Since  $y = 2^{-1/p}$ , we have  $\|b - \underline{x}\|^p \leq 2^p$  for this case as required.

**CASE 1.4 :**  $x_1, x_2, x_3 \geq 0$  and  $x_2 > x$ . Here we have  $x_1 > y$  and  $x_3 < y$ .

$$\|b - \underline{x}\|^p = (x_1 + y)^p + (x_2 - x)^p + (x_3 + y)^p.$$

Similar to the case 1.3, for fixed  $x_1^p + x_3^p$ , it takes its maximum when  $x_1 = x_3$ . So

$$\|b - \underline{x}\|^p \leq 2(x_1 + y)^p + (x_2 - x)^p$$

where  $2x_1^p + x_2^p = 2^p$ ,  $x_1 \leq y$  and  $x_2 \geq x$ . Again it takes its maximum when  $x_1 = y$  and  $x_2 = x$ . So we have

$$\|b - \underline{x}\|^p \leq 2 (2y)^p = 2^p.$$

If we take  $x_1 < y$  and  $x_3 > y$ , we can still prove that  $\|b - x\|_p \leq 2$ . Namely,

$$\|b - \underline{x}\|^p = (x_1 + y)^p + (x_2 - x)^p + (x_3 + y)^p.$$

If we repeat the above proof, we have  $\|b - \underline{x}\|_p \leq 2$  when  $x_2 > x, x_1 < y$  and  $x_3 > y$ .

Briefly, case 1.3 and case 1.4 sum up that when  $x_1, x_2, x_3 \geq 0$  and  $x_2 > x$ , we have  $\|b - \underline{x}\|_p \leq 2$ .

**CASE 1.5 :**  $x_1, x_2, x_3 \geq 0$  and  $x_3 > x, x_1 < y$  and  $x_2 < y$ .

$$\|c - \underline{x}\|^p = (x_1 + y)^p + (y - x_2)^p + (x_3 - x)^p$$

For  $(x_1 + y)^p + (y - x_2)^p + (x_3 - x)^p$  increases as  $x_2$  decreases and  $x_1, x_3$  increase.

So the right hand side takes its maximum for  $(x_1^*, 0, x_3^*)$  when  $(x_1^*)^p + (x_3^*)^p = 2^p$ , i.e.,  $x_3^* = \left(2^p - (x_1^*)^p\right)^{1/p}$  where  $x_1^* \leq y, x_3^* \geq x$ .

Let  $f(x_1^*) = (x_1^* + y)^p + (x_3^* - x)^p$  where  $(x_1^*)^p + (x_3^*)^p < 2^p$  and  $x_1^* \leq y, x_3^* \geq x$ .

$$\begin{aligned} f(x_1^*) &= (x_1^* + y)^p + (x_3^* - x)^p \\ &= (x_1^* + y)^p + \left( (2^p - (x_1^*)^p)^{1/p} - x \right)^p \\ \Rightarrow \frac{df}{dx_1^*} &= \frac{p}{(x_3^*)^{p-1}} \left( (x_1^* + y)x_3 \right)^{p-1} - \left( x_1^*(x_3^* - x) \right)^{p-1} \end{aligned}$$

Now we have  $(x_1^* + y)x_3 \geq x_1^*(x_3^* - x)$ . So  $f$  increases with  $x_1^*$  which takes its maximum at  $x_1^* = y$ .

$$\|c - \underline{x}\|^p \leq (x_1^* + y)^p + y^p + (x_3^* - x)^p \text{ where } (x_1^*)^p + (x_3^*)^p = 2^p, x_1^* \leq y, x_3^* \geq x$$

$$\begin{aligned}
\|c - \underline{x}\|^p &\leq (2y)^p + y^p + (x_3^* - x)^p \quad \text{where} \quad (x_3^*)^p = 2^p - y^p = 2^p - \frac{1}{2} \\
&= (2^p + 1)y^p + (x_3^* - x)^p \\
&= (2^p + 1)\frac{1}{2} + (x_3^* - x)^p \quad \text{for} \quad y^p = \frac{1}{2}.
\end{aligned}$$

If  $(x_3^* - x)^p \leq \frac{1}{2}(2^p - 1)$ , we have

$$\|c - \underline{x}\|^p \leq 2^p.$$

So we must prove that  $(x_3^* - x)^p \leq \frac{1}{2}(2^p - 1)$  holds. Here suppose that

$$(x_3^* - x)^p > \frac{1}{2}(2^p - 1).$$

We have that  $x_3^* = \left(2^p - \frac{1}{2}\right)^{1/p}$  and  $x = (2^p - 1)^{1/p}$ . So

$$(x_3^* - x)^p = \left(\left(2^p - \frac{1}{2}\right)^{1/p} - (2^p - 1)^{1/p}\right)^p > \frac{1}{2}(2^p - 1).$$

Hence

$$\left(2^p - \frac{1}{2}\right)^{1/p} > \left(1 + \frac{1}{2^{1/p}}\right)(2^p - 1)^{1/p}$$

$$\text{i.e. } 2^p - \frac{1}{2} > \left(1 + \frac{1}{2^{1/p}}\right)^p (2^p - 1).$$

We know that  $\frac{1}{2} \leq \frac{1}{2^{1/p}}$ . So

$$2^p - \frac{1}{2} > \frac{3}{2}(2^p - 1)$$

$$\text{i.e. } 2 \cdot 2^p - 1 > 3 \cdot 2^p - 3$$

$$\text{i.e. } 2 > 2^p$$

contradicts with  $p \geq 1$ .

Hence  $(x_3^* - x)^p \leq \frac{1}{2}(2^p - 1)$  which establishes  $\|c - x\|_p \leq 2$  as required.

**CASE 1.6 :**  $x_1, x_2, x_3 \geq 0$  and  $x_3 > x$ . First we take  $x_1 > y$  and  $x_2 < y$ .

$$\|c - \underline{x}\|^p = (x_1 + y)^p + (y - x_2)^p + (x_3 - x)^p.$$

The same analysis as in case 1.5 applies except that we can allow  $x_1$  go up to 1 since  $1^p + x^p = 2^p$  but  $x_1$  can not go beyond 1 since we assume that  $x_3 \geq x$ . So

$$\|c - \underline{x}\|^p \leq 2^p$$

If we take  $x_1 < y$  and  $x_2 > y$  when  $x_3 > x$ , we prove that  $\|c - \underline{x}\|_p \leq 2$ . Namely,

$$\|c - \underline{x}\|^p = (x_1 + y)^p + (x_2 - y)^p + (x_3 - x)^p$$

Now repeating the above proof, we have  $\|c - x\|_p \leq 2$ .

Briefly, case 1.5 and case 1.6 say that when  $x_1, x_2, x_3 \geq 0$  and  $x_3 > x$ , we have  $\|c - x\|_p \leq 2$ .

So we have shown that the “facet” for  $\ell_p$  balls determined by  $(2, 0, 0)$ ,  $(0, 2, 0)$ ,  $(0, 0, 2)$  is covered. Note that because of the symmetry, the above proof can be repeated for the facet  $(-2, 0, 0)$ ,  $(0, -2, 0)$ ,  $(0, 0, -2)$ .

Now we consider the facet for  $\ell_p$  balls determined by  $(2, 0, 0)$ ,  $(0, -2, 0)$ ,  $(0, 0, 2)$ , i.e.,  $x_1, x_3 > 0$ ,  $x_2 < 0$ .

**CASE 2.1 :**  $x_1, x_3 \geq 0$ ,  $x_2 \leq 0$  and  $x_1 > x$ . Here  $a = (x, y, y)$ . First we take  $x_2 > -y$  and  $x_3 > y$ . So we have

$$\begin{aligned} \|a - \underline{x}\|^p &= (x_1 - x)^p + (y - x_2)^p + (x_3 - y)^p. \\ &= (x_1 - x)^p + (y + (-x_2))^p + (x_3 - y)^p. \end{aligned}$$

For fixed  $(-x_2)^p + x_3^p$ ,  $(y + (-x_2))^p + (x_3 - y)^p$  takes its maximum when  $x_3 = y$ . So

$$\begin{aligned} \|a - \underline{x}\|^p &\leq (x_1 - x)^p + (y + (-x_2))^p \\ &\Rightarrow x_1^p + (-x_2)^p + y^p = 2^p. \end{aligned}$$

We know that  $x_1 > x$  and  $-x_2 < y$ . So  $x_1^p + (-x_2)^p + y^p$  decreases with  $x_1$ . So maximum when  $x_1 = x$ ,  $-x_2 = y$ .

$$\|a - \underline{x}\|^p \leq 2^p y^p \leq \frac{1}{2} 2^p.$$

$$\|a - \underline{x}\|^p \leq (x_1^* - x)^p + y^p + (x_3^* - y)^p$$

where  $(x_1^*)^p + (x_3^*)^p = 2^p$  with  $x_1^*, x_3^* \geq 0$ . So using Lemma 1.4.2,

$$\|a - \underline{x}\|^p \leq (x_1^* + x_3^* - x)^p. \quad (1.10)$$

By Holder's inequality we have

$$\begin{aligned} x_1^* + x_3^* &= 1.x_1^* + 1.x_3^* \leq 2^{1/q}.2 = 2^{1-1/p}.2 = 4.2^{-1/p} \\ \text{i.e. } x_1^* + x_3^* &\leq 4.2^{-1/p}. \end{aligned}$$

From (1.10), we need to prove that

$$(x_1^* + x_3^* - x)^p \leq 2^p.$$

Since we have  $x_1^* + x_3^* \leq 4.2^{-1/p}$ , we only need to prove that

$$x_1^* + x_3^* \leq 2 + x$$

which is true if

$$4.2^{-1/p} \leq 2 + x.$$

We know that  $x \geq 2 \cdot 2^{-1/p}$ , so we only need to show that

$$\begin{aligned} 4 \cdot 2^{-1/p} &\leq 2 + 2 \cdot 2^{-1/p} \\ 2^{-1/p} &\leq 1 \end{aligned}$$

which holds for  $p > 0$ . So for this case  $\|a - \underline{x}\|_p \leq 2$  holds.

If we take  $x_2 < -y$  and  $x_3 < y$  when  $x_1 > x$ , we prove that  $\|a - \underline{x}\|_p \leq 2$ . Namely, we have

$$\begin{aligned} \|a - \underline{x}\|^p &= (x_1 - x)^p + (y - x_2)^p + (y - x_3)^p \\ &\leq (x_1^* - x)^p + (y - x_2^*)^p + y^p \end{aligned}$$

Here  $(x_1^*)^p + (-x_2^*)^p = 2^p$  which increases with  $-x_2^*$ , so

$$\|a - \underline{x}\|^p = 2y^p + y^p + (x_1^* - x)^p \leq 2^p$$

as in case 1.5. So we have  $\|a - \underline{x}\|_p \leq 2$ .

**CASE 2.2 :**  $x_1, x_3 \geq 0, x_2 \leq 0$  and  $x_1 > x, x_2 > -y$  and  $x_3 < y$

$$\|a - \underline{x}\|^p = (x_1 - x)^p + (y - x_2)^p + (y - x_3)^p.$$

We can reduce  $x_3$  and increase  $-x_2, x_1$  subject to  $x_1 > x, x_2 > -y$  to deduce

$$\|a - \underline{x}\|^p \leq (x_1 - x)^p + (y - x_2)^p + y^p$$

where  $x_1 > x, x_2 > -y$  and  $x_1^p + (-x_2)^p = 2^p$ .

Now we define the function  $f$ :

$$f(x_1) = (x_1 - x)^p + (y - x_2)^p + y^p$$

$$\frac{df}{dx_1} = p(x_1 - x)^{p-1} - p(y - x_2)^{p-1} \frac{dx_2}{dx_1}. \quad (1.11)$$

where  $px_1^{p-1} - p(-x_2)^{p-1} \frac{dx_2}{dx_1} = 0$ . So we have

$$\frac{dx_2}{dx_1} = \frac{x_1^{p-1}}{(-x_2)^{p-1}}.$$

Together with (1.11), we get

$$\frac{df}{dx_1} = \frac{p}{(-x_2)^{p-1}} \left( (-x_2)^{p-1} (x_1 - x)^{p-1} - (y - x_2)^{p-1} x_1^{p-1} \right).$$

So we have  $\frac{df}{dx_1} \leq 0$  if  $-x_2(x_1 - x) \leq (y - x_2)x_1$ , i.e.,  $x_2x \leq yx_1$ . But we know that  $x < x_1$  and  $x_2 < 0 < y$ . Hence we get  $x_2x \leq yx_1$ . Having  $-x_2 = y$ , we get  $x_1^p = 2^p - y^p$ .

$$\text{So } \frac{df}{dx_1} \leq 0 \text{ holds.}$$

The maximum occurs when  $x_1$  is as small as possible and  $-x_2$  is as large as possible subject to  $x_1 > x$ ,  $-x_2 < y$  and  $x_1^p + (-x_2)^p = 2^p$ . This occurs when  $-x_2 = y$ .

$$\begin{aligned} x_1^p + (-x_2)^p &= 2^p \text{ and } -x_2 = y \\ x_1^p = 2^p - y^p &> 2^p - 2y^p = x^p. \end{aligned}$$

So we have  $x_1 > x$  when  $-x_2 = y$ . Having  $-x_2 = y$ , we get  $x_1 = 2^p - y^p = 2^p - \frac{1}{2}$  since  $y^p = \frac{1}{2}$ .

If  $(x_1 - x)^p \leq \frac{1}{2} 2^p - \frac{1}{2}$ ,

$$\|a - \underline{x}\|^p \leq (x_1 - x)^p + (2^p + 1)2^{-1} \leq 2^p.$$

We have  $x_1 = \left(2^p - \frac{1}{2}\right)^{1/p}$  and  $x = (2^p - 1)^{1/p}$ . This means that

$$x_1 - x = \left(2^p - \frac{1}{2}\right)^{1/p} - (2^p - 1)^{1/p} \leq \frac{1}{2^{1/p}}(2^p - 1)^{1/p}$$

$$\Leftrightarrow 2^p - \frac{1}{2} \leq \left(1 + \frac{1}{2^{1/p}}\right)^p (2^p - 1)$$

$$\Leftrightarrow \frac{1}{2} \leq \left(\left(1 + \frac{1}{2^{1/p}}\right)^p - 1\right)(2^p - 1)$$



Here we should emphasize that  $(1+x)^p \geq 1+px$  where  $x \geq 0$ .

We have  $\left(1 + \frac{1}{2^{1/p}}\right)^p \geq 1 + \frac{p}{2^{1/p}}$  and  $2^p - 1 \geq p$ .

$$\begin{aligned} \text{So } \left(\left(1 + \frac{1}{2^{1/p}}\right)^p - 1\right)(2^p - 1) &\geq \frac{p}{2^{1/p}}(2^p - 1) \\ &\geq \frac{p^2}{2^{1/p}} \geq \frac{1}{2} \text{ which increases with } p. \end{aligned}$$

So  $\|a - \underline{x}\|^p \leq 2^p$ .

**CASE 2.3 :**  $x_1, x_3 \geq 0, x_2 \leq 0$  and  $x_3 > x$ . First we take  $x_1 > y$  and  $x_2 > -y$ . Here  $c = (-y, y, x)$ .

$$\|c - \underline{x}\|^p = (x_1 + y)^p + (y - x_2)^p + (x_3 - x)^p.$$

If  $x_1^p + (-x_2)^p$  is fixed,  $(x_1 + y)^p + (y + (-x_2))^p$  is maximal when  $x_1 = -x_2$  as in case 1.5. So

$$\|c - \underline{x}\|^p \leq 2(x_1^* + y)^p + (x_3^* - x)^p$$

where  $2(x_1^*)^p + (x_3^*)^p = 2^p$ . This leads us to the following:

$$\begin{aligned} 2p(x_1^*)^{p-1} + p(x_3^*)^{p-1} \frac{\partial x_3^*}{\partial x_1^*} &= 0 \\ \frac{\partial x_3^*}{\partial x_1^*} &= -2\left(\frac{x_1^*}{x_3^*}\right)^{p-1}. \end{aligned}$$

Let  $f = 2(x_1^* + y)^p + (x_3^* - x)^p$ .

$$\begin{aligned} \frac{\partial f}{\partial x_1^*} &= \frac{\partial f}{\partial x_1^*} \frac{\partial x_1^*}{\partial x_1^*} + \frac{\partial f}{\partial x_3^*} \frac{\partial x_3^*}{\partial x_1^*} \\ &= 2p(x_1^* + y)^{p-1} - 2p(x_3^* - x)^{p-1} \left(\frac{x_1^*}{x_3^*}\right)^{p-1} \\ &= \frac{2p}{(x_3^*)^{p-1}} \left( \left((x_1^* + y)x_3^*\right)^{p-1} - \left((x_3^* - x)x_1^*\right)^{p-1} \right). \end{aligned}$$

Now  $(x_1^* + y)x_3^* \geq (x_3^* - x)x_1^*$ . So  $f$  is maximal when  $x_1$  takes its maximum subject to  $x_3 > x$ . So

$$f \leq 2(2y)^p = 2^p.$$

If we take  $x_2 < -y$  and  $x_1 < y$  when  $x_3 > x$ , we prove that  $\|c - \underline{x}\|_p \leq 2$ . Namely,

$$\|c - \underline{x}\|_p^p = (x_1 + y)^p + (y - x_2)^p + (x_3 - x)^p$$

We repeat the above proof. So we have  $\|c - \underline{x}\|_p \leq 2$ .

**CASE 2.4 :**  $x_1, x_3 \geq 0, x_2 \leq 0$  and  $x_3 > x$  while  $x_1 < y$  and  $x_2 > -y$ . We prove that  $\|c - \underline{x}\|_p \leq 2$ .

$$\|c - \underline{x}\|_p^p = (x_1 + y)^p + (y - x_2)^p + (x_3 - x)^p$$

For fixed  $x_1^p + (-x_2)^p$ ,  $(x_1 + y)^p + (y - x_2)^p$  is maximal when  $x_1 = -x_2$  as in case 1.3. So when  $x_1^* < y$  and  $x_3 > x$ , we have

$$\|c - \underline{x}\|_p^p \leq 2(x_1^* + y)^p + (x_3 - x)^p.$$

Again, as in case 1.3, the right hand side increases with  $x_1^*$  subject to  $x_1^* < y$ . So  $\|c - \underline{x}\|_p \leq 2(2y)^p = 2^p$ .

Briefly, case 2.3 and 2.4 sum up that when  $x_1, x_3 > 0, x_2 < 0$  and  $x_3 > x$ , we have  $\|c - \underline{x}\|_p \leq 2$ . So we have shown that the facet for  $\ell_p$  balls determined by  $(-2, 0, 0), (0, 2, 0), (0, 0, -2)$  is covered. Because of the symmetry of  $\ell_p$ -ball, the above proof can be repeated for  $(2, 0, 0), (0, -2, 0), (0, 0, 2)$ .

Now we consider the facet for  $\ell_p$  balls determined by  $(-2, 0, 0), (0, 2, 0), (0, 0, 2)$ . Here  $x_1 < 0, x_2, x_3 > 0$ .

**CASE 3.1 :**  $x_1 \leq 0$ ,  $x_2, x_3 \geq 0$  and  $x_2 > x$ . First we take  $x_1 < -y$  and  $x_3 < y$ . Here note that  $b = (-y, x, -y)$ .

$$\|b - \underline{x}\|^p = (-x_1 - y)^p + (x_2 - x)^p + (x_3 + y)^p$$

Now for fixed  $(-x_1)^p + x_3^p = (x'_1)^p + x_3^p$  where  $x'_1 = -x_1$ .

$$\begin{aligned} \frac{d}{dx'_1} \left( (x'_1 - y)^p + (x_3 + y)^p \right) &= \frac{p}{x_3^{p-1}} \left( (x_3(x'_1 - y))^{p-1} - (x'_1(x_3 + y))^{p-1} \right) \\ &\leq 0 \quad \text{since} \quad x_3(x'_1 - y) \leq x'_1(x_3 + y). \end{aligned}$$

So maximum occurs when  $x'_1$  is minimal, i.e.,  $x'_1 = y$ . Hence

$$\|b - \underline{x}\|^p \leq (x_2^* - x)^p + (x_3^* + y)^p$$

where  $y^p + (x_2^*)^p + (x_3^*)^p = 2^p$ . So

$$\begin{aligned} \frac{d}{dx_2^*} (x_2^* - x)^p + (x_3^* + y)^p &= \frac{p}{(x_3^*)^{p-1}} \left( (x_3^*)^{p-1} (x_2^* - x)^{p-1} - (x_3^* + y)^{p-1} (x_2^*)^{p-1} \right) \\ &\leq 0 \quad \text{as} \quad x_3^*(x_2^* - x) \leq (x_3^* + y)x_2^*. \end{aligned}$$

So  $\|b - \underline{x}\|^p \leq (2y)^p = \frac{1}{2} 2^p$ .

If we take  $x_1 > -y$  and  $x_2 > x$  when  $x_3 > y$ , we prove that  $\|b - \underline{x}\|_p \leq 2$ . Namely,

$$\|b - \underline{x}\|^p = (y + x_1)^p + (x_2 - x)^p + (y + x_3)^p$$

If we increase  $x_1$  to 0 and  $x_2$  and  $x_3$  are increased, we have

$$\begin{aligned} \|b - \underline{x}\|^p &= (y + x_1)^p + (x_2 - x)^p + (y + x_3)^p \\ &\leq y^p + (x_2 - x)^p + (y + x_3)^p. \end{aligned}$$

We know that  $x_2 > x$  and  $x_3 > y$ , i.e.,  $x_2^p + x_3^p = 2^p$ . As in case 1.5, we have  $\|b - \underline{x}\|_p \leq 2$ .

**CASE 3.2 :**  $x_1 \leq 0$ ,  $x_2, x_3 \geq 0$  and  $x_2 > x$ . Here we take  $x_1 > -y$  and  $x_3 < y$

$$\|b - \underline{x}\|^p = (x_1 + y)^p + (x_2 - x)^p + (x_3 + y)^p$$

If we increase  $x_1$  to 0 and increase  $x_2$  and  $x_3$  subject to  $x_3 < y$  we have

$$\begin{aligned} \|b - \underline{x}\|^p &\leq y^p + (x_2 - x)^p + (x_3 + y)^p \\ &\leq 2^p \end{aligned}$$

as in case 3.1 part 2.

Briefly, case 3.1 and 3.2 prove that for  $x_1 \leq 0$ ,  $x_2, x_3 \geq 0$  and  $x_2 > x$ , we have  $\|b - x\|_p \leq 2$ .

**CASE 3.3 :**  $x_1 \leq 0$ ,  $x_2, x_3 \geq 0$  and  $x_3 > x$ . First we consider  $x_1 < -y$  and  $x_2 < y$ .

$$\begin{aligned} \|c - \underline{x}\|^p &= (-y - x_1)^p + (y - x_2)^p + (x_3 - x)^p \\ &\leq (-y + x_1^*)^p + (x_3^* - x)^p + y^p. \end{aligned}$$

Here  $(x_1^*)^p + (x_3^*)^p = 2^p$  where  $x_1^* > y$  and  $x_3^* > x$ . So

$$\|c - \underline{x}\|^p \leq (x_1^* + x_3^* - x)^p.$$

Now we define  $f(x_1^*) = (x_1^* + x_3^* - x)^p$ .

$$\begin{aligned} \frac{df}{dx_1^*} &= p(x_1^* + x_3^* - x)^{p-1} \left( 1 + \frac{dx_3^*}{dx_1^*} \right) \\ &= p(x_1^* + x_3^* - x)^{p-1} \left( 1 - \frac{(x_1^*)^{p-1}}{(x_3^*)^{p-1}} \right) \\ &= \frac{p}{(x_3^*)^{p-1}} (x_1^* + x_3^* - x)^{p-1} \left( (x_3^*)^{p-1} - (x_1^*)^{p-1} \right). \end{aligned}$$

Now we have

$$x_3^* \geq x^p = 2^p - 1 \geq 1$$

$$(x_1^*)^p = 2^p - (x_3^*)^p \leq 2^p - (2^p - 1) < 1$$

$$x_3^* \geq x_1^*, \text{ i.e., } \frac{df}{dx_1^*} \geq 0.$$

So maximum occurs when  $x_1^*$  is maximum, i.e.,  $x_3^* = x$  and  $x_1^* = (2^p - x^p)^{1/p}$ , i.e.,  $x_1^* = 1$ . So

$$f(x_1^*) = (x_1^* + x_3^* - x)^p = 1, \text{ i.e., } \|c - \underline{x}\|^p \leq 1 < 2^p.$$

If we take  $x_1 > -y$  and  $x_3 > x$  when  $x_2 > y$ , we prove that  $\|c - \underline{x}\|_p \leq 2$ . Namely,

$$\begin{aligned} \|c - \underline{x}\|^p &= (x_1 + y)^p + (x_2 - y)^p + (x_3 - x)^p \\ &\leq (-y + x_2^*)^p + (x_3^* - x)^p + y^p \\ &\leq (x_2^* + x_3^* - x)^p. \end{aligned}$$

Here  $(x_2^*)^p + (x_3^*)^p = 2^p$  where  $x_2^* > y$  and  $x_3^* > x$ . Now we define  $f(x_2^*) = (x_2^* + x_3^* - x)^p$ .

$$\begin{aligned} \frac{df}{dx_2^*} &= p(x_2^* + x_3^* - x)^{p-1} \left( 1 + \frac{dx_3^*}{dx_2^*} \right) \\ &= p(x_2^* + x_3^* - x)^{p-1} \left( 1 - \frac{(x_2^*)^{p-1}}{(x_3^*)^{p-1}} \right) \\ &= \frac{p}{(x_3^*)^{p-1}} (x_2^* + x_3^* - x)^{p-1} \left( (x_3^*)^{p-1} - (x_2^*)^{p-1} \right). \end{aligned}$$

Now we have

$$x_3^* \geq x^p = 2^p - 1 \geq 1$$

$$(x_2^*)^p = 2^p - (x_3^*)^p \leq 2^p - (2^p - 1) < 1$$

$$x_3^* \geq x_2^*, \text{ i.e., } \frac{df}{dx_1^*} \geq 0.$$

So maximum occurs when  $x_2^*$  is maximum, i.e.,  $x_3^* = x$  and  $x_2^* = (2^p - x^p)^{1/p}$ , i.e.,  $x_2^* = 1$ . So

$$f(x_1^*) = (x_1^* + x_3^* - x)^p = 1, \text{ i.e., } \|c - \underline{x}\|^p \leq 1 < 2^p.$$

So we have  $\|c - \underline{x}\|^p \leq 2^p$ .

**CASE 3.4 :**  $x_1 \leq 0, x_2, x_3 \geq 0$  and  $x_3 > x$ . First we take  $x_1 > -y$  and  $x_2 < y$ .

$$\begin{aligned} \|c - \underline{x}\|^p &= (x_1 + y)^p + (y - x_2)^p + (x_3 - x)^p \\ &\leq (x_1^* + y)^p + (x_3^* - x)^p + y^p \end{aligned}$$

where  $x_1^* + y \leq 0, x_2^* = 0$  and  $x_3^* > x$ , so  $(x_1^*)^p + (x_3^*)^p = 2^p$ . Then we have  $(x_3^*)^p = (2^p - (x_1^*)^p)^{1/p}$  where  $x_1^* \leq y$  and  $(x_3^*)^p \geq x$ .

Let  $f(x_1) = (x_1^* + y)^p + (x_3^* - x)^p$  where  $(x_1^*)^p + (x_3^*)^p = 2^p$  and  $x_1^* \leq y, x_3^* \geq x$ .

$$\begin{aligned} f(x_1^*) &= (x_1^* + y)^p + (x_3^* - x)^p \\ &= (x_1^* + y)^p + \left( (2^p - (x_1^*)^p)^{1/p} - x \right)^p \\ \Rightarrow \frac{df}{dx_1^*} &= \frac{p}{(x_3^*)^{p-1}} \left( (x_1^* + y)x_3 \right)^{p-1} - \left( x_1^*(x_3^* - x)^{p-1} \right) \end{aligned}$$

Now we have  $(x_1^* + y)x_3 \geq x_1^*(x_3^* - x)$ . So  $f$  increases with  $x_1^*$  which takes its maximum at  $x_1^* = y$ .

$$\begin{aligned} \|c - \underline{x}\|^p &\leq (x_1^* + y)^p + y^p + (x_3^* - x)^p \text{ where } (x_1^*)^p + (x_3^*)^p = 2^p, x_1^* \leq y, x_3^* \geq x \\ \|c - \underline{x}\|^p &\leq (2y)^p + y^p + (x_3^* - x)^p \text{ where } (x_3^*)^p = 2^p - y^p = 2^p - \frac{1}{2} \end{aligned}$$

$$\begin{aligned} &\leq (2^p + 1)y^p + (x_3^* - x)^p \\ &= (2^p + 1)\frac{1}{2} + (x_3^* - x)^p \quad \text{as } y^p = \frac{1}{2}. \end{aligned}$$

If  $(x_3^* - x)^p \leq \frac{1}{2}(2^p - 1)$ , we have

$$\|c - \underline{x}\|^p \leq 2^p.$$

So we will prove that  $(x_3^* - x)^p \leq \frac{1}{2}(2^p - 1)$  holds. Here in order to get a contradiction, we suppose that

$$(x_3^* - x)^p > \frac{1}{2}(2^p - 1).$$

We have that  $x_3^* = \left(2^p - \frac{1}{2}\right)^{-1/p}$  and  $x = (2^p - 1)^{1/p}$ . So

$$\begin{aligned} (x_3^* - x)^p &= \left( \left(2^p - \frac{1}{2}\right)^{1/p} - (2^p - 1)^{1/p} \right)^p > \frac{1}{2}(2^p - 1) \\ &\Leftrightarrow \left(2^p - \frac{1}{2}\right)^{1/p} > \left(1 + \frac{1}{2^{1/p}}\right)(2^p - 1)^{1/p} \\ &\Leftrightarrow 2^p - \frac{1}{2} > \left(1 + \frac{1}{2^{1/p}}\right)^p (2^p - 1). \end{aligned}$$

We know that  $\frac{1}{2} \leq \frac{1}{2^{1/p}}$ . So we only need to show that

$$\begin{aligned} 2^p - \frac{1}{2} &> \left(\frac{3}{2}\right)^p (2^p - 1) \\ \text{or } 2^p - \frac{1}{2} &> \frac{3}{2} (2^p - 1) \\ 2 \cdot 2^p - 1 &> 3 \cdot 2^p - 3 \\ 2 &> 2^p \end{aligned}$$

contradicts with  $p \geq 1$ . For this case, we have  $\|c - \underline{x}\|_p \leq 2$ .

Briefly, case 3.3 and 3.4 sum up that for  $x_1 \leq 0$ ,  $x_2, x_3 \geq 0$  and  $x_3 > x$ , we have  $\|c - \underline{x}\|_p \leq 2$ .

So the “facet” for the  $\ell_p$ -balls determined by  $(-2, 0, 0)$ ,  $(0, 2, 0)$ ,  $(0, 0, 2)$  is covered. By symmetry, the facet  $(2, 0, 0)$ ,  $(0, -2, 0)$ ,  $(0, 0, -2)$  is also covered.

Now we should consider the facets which does not contain the  $\{\mp a, \mp b, \mp c\}$ , i.e., the “facets” determined by

$$(2, 0, 0), (0, 2, 0), (0, 0, -2)$$

$$(-2, 0, 0), (0, -2, 0), (0, 0, 2).$$

Now we consider the “facet” for  $\ell_p$  balls determined by  $(2, 0, 0)$ ,  $(0, 2, 0)$ ,  $(0, 0, -2)$ . Here  $x_1, x_2 > 0$ ,  $x_3 < 0$ .

**CASE 4.1 :**  $x_1, x_2 \geq 0, x_3 \leq 0$  and  $x_1 > x$ . First we take  $x_2 < y$  and  $x_3 < -y$ .

$$\|a - \underline{x}\|^p = (x_1 - x)^p + (y - x_2)^p + (y - x_3)^p.$$

If we increase  $-x_3$  and  $x_1$  subject to  $x_1 > x$ ,  $-x_3 > y$  and decrease  $x_2$ , we obtain

$$\|a - \underline{x}\|^p = (x_1^* - x)^p + (y + x_3^*)^p + y^p$$

where  $(x_1^*)^p + (x_3^*)^p = 2^p$  for  $x_1^* > x$  and  $x_3^* > y$ .

Here we define  $f(x_1^*) = (x_1^* - x)^p + (y + x_3^*)^p + y^p$ .

$$\frac{df}{dx_1^*} = p(x_1^* - x)^{p-1} + p(y + x_3^*)^{p-1} \frac{dx_3^*}{dx_1^*}.$$

Here  $(x_1^*)^{p-1} + (x_3^*)^{p-1} \cdot \frac{dx_3^*}{dx_1^*} = 0$ . So

$$\frac{df}{dx_1^*} = \frac{p}{(x_3^*)^{p-1}} \left( (x_1^* - x)^{p-1} (x_3^*)^{p-1} - (y + x_3^*)^{p-1} (x_1^*)^{p-1} \right)$$

$$= \frac{p}{(x_3^*)^{p-1}} \left( ((x_1^* - x)x_3^*)^{p-1} - ((y + x_3^*)x_1^*)^{p-1} \right)$$

$$\leq 0 \text{ since } (x_1^* - x)x_3^* \leq (y + x_3^*)x_1^*, \quad p \geq 1.$$



So  $f(x_1^*)$  is maximal when  $x_1^* = x$  and  $(x_3^*)^p = 2^p - x^p = 1$ , i.e.,  $x_3^* = 1$ . This means that

$$\begin{aligned} \|a - \underline{x}\|^p &\leq y^p + (y + 1)^p \\ &= \frac{1}{2} + \left(1 + \frac{1}{2^{1/p}}\right)^p. \end{aligned}$$

Now we need to show that

$$\begin{aligned} \frac{1}{2} + \left(1 + \frac{1}{2^{1/p}}\right)^p &\leq 2^p, \quad 1 \leq p \leq \frac{\log 3}{\log 2} \\ \text{i.e. } \frac{1}{2} &\leq 2^p - \left(1 + \frac{1}{2^{1/p}}\right)^p, \quad 1 \leq p \leq \frac{\log 3}{\log 2}. \end{aligned} \quad (1.12)$$

We know that for any number  $b$  satisfying  $0 < a \leq b$ , we have  $(b - a)b^{p-1} \leq b^p - a^p$  where  $p \geq 1$ . So, as  $2 \geq 1 + \frac{1}{2^{1/p}}$ , we have

$$2^p - \left(1 + \frac{1}{2^{1/p}}\right)^p \geq \left(1 - \frac{1}{2^{1/p}}\right)2^{p-1}.$$

So if we prove that

$$\left(1 - \frac{1}{2^{1/p}}\right)2^{p-1} \geq \frac{1}{2}$$

holds, the statement (1.12) follows. So we need to show

$$\frac{1}{2} \leq \left(1 - \frac{1}{2^{1/p}}\right)2^{p-1}. \quad (1.13)$$

$$\text{Now } \frac{1}{2} \leq \left(1 - \frac{1}{2^{1/p}}\right)2^{p-1} \quad \text{if } \frac{1}{2^p} \leq 1 - \frac{1}{2^{1/p}}$$

$$\text{i.e. } \frac{1}{2^p} + \frac{1}{2^{1/p}} \leq 1, \quad \text{for } 1 \leq p \leq \frac{\log 3}{\log 2}.$$

We define  $f(p) = \frac{1}{2^p} + \frac{1}{2^{1/p}}$ . We expect  $f(p)$  to be decreasing when  $1 \leq p \leq \frac{\log 3}{\log 2}$ .

$$\begin{aligned} f(p) &= e^{-p \log 2} + e^{-1/p \log 2} \\ f'(p) &= -\log 2 e^{-p \log 2} + \frac{1}{p^2} \log 2 e^{-1/p \log 2} \\ &= \log 2 \left( -2^{-p} + \frac{1}{p^2} 2^{-1/p} \right) \end{aligned}$$

Now  $\log 2 > 0$ , so  $f'(p)$  is negative if

$$\begin{aligned} 2^{-p} &\geq \frac{2^{-1/p}}{p^2} \quad \text{where } 1 \leq p \leq \frac{\log 3}{\log 2} \\ \Leftrightarrow 2^{-p^2} p^{2p} &\geq \frac{1}{2} \quad \text{where } 1 \leq p \leq \frac{\log 3}{\log 2} \\ \Leftrightarrow (p^2 2^{-p})^p &\geq \frac{1}{2} \quad \text{where } 1 \leq p \leq \frac{\log 3}{\log 2}. \end{aligned}$$

As equality holds when  $p = 1$ , this will hold if the function  $g(p) = p^2 2^{-p}$  is increasing for  $1 \leq p \leq \frac{\log 3}{\log 2}$ . Now

$$\begin{aligned} g(p) &= p^2 e^{-p \log 2} \\ g'(p) &= 2p e^{-p \log 2} - (\log 2) p^2 e^{-p \log 2} = p \cdot 2^{-p} \cdot (2 - p \log 2). \end{aligned}$$

So  $g'(p) \geq 0$  if  $2 \geq p \log 2$ , i.e.,  $\frac{2}{\log 2} \geq p$ . Now

$$\frac{2}{\log 2} > \frac{\log 3}{\log 2} \quad \text{since } 2 > \log 3.$$

So  $g(p)$  is increasing for  $1 \leq p \leq \frac{\log 3}{\log 2}$ . Therefore  $f(p) \leq f(1) = 1$ ,  $1 \leq p \leq \frac{\log 3}{\log 2}$ .

Hence

$$f(p) = \frac{1}{2^p} + \frac{1}{2^{1/p}} \leq 1$$

$$1 - \frac{1}{2^{1/p}} \geq \frac{1}{2^p}$$

$$\left(1 - \frac{1}{2^{1/p}}\right) 2^{p-1} \geq \frac{1}{2}.$$

where  $1 \leq p \leq \frac{\log 3}{\log 2}$ . So we have proved (1.12), and the statement (1.13) follows. Hence the first part of case 4.1 is established.

If we take  $x_1 > x$  and  $x_2 > y$  when  $x_3 > -y$ , we prove that  $\|a - \underline{x}\|_p \leq 2$ . Namely,

$$\begin{aligned} \|a - \underline{x}\|^p &= (x_1 - x)^p + (x_2 - y)^p + (y - x_3)^p. \\ &= (x_1 - x)^p + (x_2 - y)^p + (y + (-x_3))^p. \end{aligned}$$

For  $x_2 > y$ ,  $x_3 > -y$ , and  $x_2^p + (-x_3)^p$  fixed,  $(x_2 - y)^p + (y + (-x_3))^p$  takes its maximum when  $x_2 = y$ . As in case 3.1, we take  $-x_3 = x_3^*$ , so  $x_2^p + (-x_3)^p = x_2^p + (x_3^*)^p$  where

$$\begin{aligned} \frac{d}{dx_3^*} \left( (x_3^* + y)^p + (x_2 - y)^p \right) &= \frac{p}{x_2^{p-1}} \left( (x_3^*(x_2 - y))^{p-1} - (x_2(x_3^* + y))^{p-1} \right) \\ &\leq 0 \quad \text{since} \quad x_3^*(x_2 - y) \leq x_2(x_3^* + y). \end{aligned}$$

So maximum occurs when  $x_2$  is minimal, i.e.,  $x_2 = y$ . Hence

$$\|a - \underline{x}\|^p \leq (x_1^* - x)^p + (x_3^* + y)^p$$

where  $(x_1^*)^p + (x_3^*)^p + y^p = 2^p$ ,  $0 < x_3^* < y$  and  $x_1 > x$ .

If we define  $f(x_1) = (x_1^* - x)^p + (y + x_3^*)^p$ , we have

$$\begin{aligned} \frac{d}{dx_1^*} \left( (x_1^* - x)^p + (y + x_3^*)^p \right) &= \frac{p}{(x_3^*)^{p-1}} \left( (x_3^*)^{p-1} (x_1^* - x)^{p-1} - (x_3^* + y)^{p-1} (x_1^*)^{p-1} \right) \\ &\leq 0 \quad \text{as} \quad x_3^*(x_1^* - x) \leq (x_3^* + y)x_1^*. \end{aligned}$$

So maximum occurs when  $x_1 = x$ . So  $\|a - \underline{x}\|^p \leq (2y)^p = \frac{1}{2} 2^p < 2^p$ .

**CASE 4.2 :**  $x_1, x_2 \geq 0, x_3 \leq 0$  and  $x_1 > x$ ,  $x_2 < y$  and  $x_3 > -y$ . We have

$$\|a - \underline{x}\|^p = (x_1 - x)^p + (y - x_2)^p + (y - x_3)^p.$$

We can reduce  $x_2$  and increase  $-x_3, x_1$  subject to  $x_1 > x$ ,  $x_3 > -y$  to deduce

$$\|a - \underline{x}\|^p \leq (x_1 - x)^p + (y - x_3)^p + y^p$$

where  $x_1 > x$ ,  $x_3 > -y$  and  $x_1^p + (-x_3)^p = 2^p$ .

Now we define the function  $f$ :

$$f(x_1) = (x_1 - x)^p + (y - x_3)^p + y^p$$

$$\frac{df}{dx_1} = p(x_1 - x)^{p-1} - p(y - x_3)^{p-1} \frac{dx_3}{dx_1}. \quad (1.14)$$

where  $px_1^{p-1} - p(-x_3)^{p-1} \frac{dx_3}{dx_1} = 0$ . So we have

$$\frac{dx_3}{dx_1} = \frac{x_1^{p-1}}{(-x_3)^{p-1}}.$$

Together with (1.14), we get

$$\frac{df}{dx_1} = \frac{p}{(-x_3)^{p-1}} \left( (-x_3)^{p-1} (x_1 - x)^{p-1} - (y - x_3)^{p-1} x_1^{p-1} \right).$$

So we have  $\frac{df}{dx_1} \leq 0$  if  $-x_3(x_1 - x) \leq (y - x_3)x_1$ , i.e.,  $x_3x \leq yx_1$ . But we know that  $x_1 > x$  and  $-x_3 < y$ . Hence we get  $-yx < x_3x \leq yx_1$ , i.e.,  $-x \leq x_1$ .

$$\text{So } \frac{df}{dx_1} \leq 0 \text{ holds.}$$

The maximum occurs when  $x_1$  is as small as possible and  $-x_3$  is as large as possible subject to  $x_1 > x$ ,  $-x_3 < y$  and  $x_1^p + (-x_3)^p = 2^p$ . This occurs when  $-x_3 = y$ .

$$\begin{aligned} x_1^p + (-x_3)^p &= 2^p \text{ and } -x_3 = y \\ x_1^p = 2^p - y^p &> 2^p - 2y^p = x^p. \end{aligned}$$

So  $x_1 > x$  when  $-x_3 = y$ . Having  $-x_3 = y$ , we get  $x_1^p = 2^p - y^p = 2^p - \frac{1}{2}$  since  $y^p = \frac{1}{2}$ .

If  $(x_1 - x)^p \leq \frac{1}{2} 2^p - \frac{1}{2}$ , then

$$\|a - \underline{x}\|^p \leq (x_1 - x)^p + (2^p + 1)2^{-1} \leq 2^p,$$

as required. So we need to show

$$(x_1 - x)^p \leq \frac{1}{2}(2^p - 1). \quad (1.15)$$

We have  $x_1 = \left(2^p - \frac{1}{2}\right)^{1/p}$  and  $x = (2^p - 1)^{1/p}$ . This means that

$$\begin{aligned} x_1 - x &= \left(2^p - \frac{1}{2}\right)^{1/p} - (2^p - 1)^{1/p} \leq \frac{1}{2^{1/p}}(2^p - 1)^{1/p} \\ \iff 2^p - \frac{1}{2} &\leq \left(1 + \frac{1}{2^{1/p}}\right)^p (2^p - 1) \\ \iff \frac{1}{2} &\leq \left(\left(1 + \frac{1}{2^{1/p}}\right)^p - 1\right)(2^p - 1) \end{aligned}$$

As  $(1 + x)^p \geq 1 + px$  where  $x \geq 0$ , we have  $\left(1 + \frac{1}{2^{1/p}}\right)^p \geq 1 + \frac{p}{2^{1/p}}$  and  $2^p - 1 \geq p$ .

$$\begin{aligned} \text{So } \left(\left(1 + \frac{1}{2^{1/p}}\right)^p - 1\right)(2^p - 1) &\geq \frac{p}{2^{1/p}}(2^p - 1) \\ &\geq \frac{p^2}{2^{1/p}} \text{ which increases with } p. \end{aligned}$$

$$\text{So } \left(\left(1 + \frac{1}{2^{1/p}}\right)^p - 1\right)(2^p - 1) \geq \frac{1}{2} \text{ which proves (1.15).}$$

Hence  $\|a - \underline{x}\|^p \leq 2^p$ .

Briefly, case 4.1 and 4.2 prove that for  $x_1, x_2 \geq 0, x_3 \leq 0$  and  $x_1 > x$ , we have  $\|a - x\|_p \leq 2$ .

**CASE 4.3 :**  $x_1, x_2 \geq 0, x_3 \leq 0$  and  $x_2 > x$ . First we take  $x_1 < y$  and  $x_3 < -y$ .

$$\|b - \underline{x}\|^p = (x_1 + y)^p + (x_2 - x)^p + (-x_3 - y)^p$$

Now for fixed  $x_1$  and  $x_3$ , we have  $x_1^p + (-x_3)^p = x_1^p + (x'_3)^p$  where  $x'_3 = -x_3$ ,

$$\begin{aligned} \frac{d}{dx'_3}(x'_3 - y)^p + (x_1 + y)^p &= \frac{p}{x_1^{p-1}} \left( (x_1(x'_3 - y))^{p-1} - (x'_3(x_1 + y))^{p-1} \right) \\ &\leq 0 \quad \text{since } x_1(x'_3 - y) \leq x'_3(x_1 + y). \end{aligned}$$

So maximum occurs when  $x'_3$  is minimal, i.e.,  $x'_3 = y$ . Hence

$$\|b - \underline{x}\|^p \leq (x_2^* - x)^p + (x_1^* + y)^p$$

where  $y^p + (x_2^*)^p + (x_1^*)^p = 2^p$ . So

$$\begin{aligned} \frac{d}{dx_2^*}(x_2^* - x)^p + (x_1^* + y)^p &= \frac{p}{(x_1^*)^{p-1}} \left( (x_1^*)^{p-1}(x_2^* - x)^{p-1} - (x_1^* + y)^{p-1}(x_2^*)^{p-1} \right) \\ &\leq 0 \quad \text{as } x_1^*(x_2^* - x) \leq (x_1^* + y)x_2^*. \end{aligned}$$

So  $(x_2^* - x)^p + (x_1^* + y)^p$  decreases with  $x_2^*$  increasing subject to  $x_2^* > x$ . Hence the maximum occurs when  $x_2^* = x$  and  $x_1^* = y$ . Then  $(x_2^* - x)^p + (x_1^* + y)^p = 2^p$ . So  $\|b - \underline{x}\|^p \leq (2y)^p = \frac{1}{2} 2^p \leq 2^p$ .

If we have  $x_1 > y$  and  $x_3 > -y$ , while  $x_2 > x$ , then

$$\begin{aligned} \|b - \underline{x}\|^p &= (x_1 - y)^p + (x_2 - x)^p + (x_3 + y)^p \\ &\leq (x_1 - y)^p + (x_2 - x)^p + y^p \end{aligned}$$

where  $x_1^p + x_2^p = 2^p$  and  $x_1 > y$ ,  $x_2 > x$ . If  $f(x_1) = (x_1 + y)^p + (x_2 - x)^p$ , then

$$\begin{aligned} \frac{df}{dx_1} &= \frac{p}{x_1^{p-1}} \left( (x_2(x_1 + y))^{p-1} - (x_1(x_2 - x))^{p-1} \right) \\ \Rightarrow \frac{df}{dx_1} &\geq 0 \text{ since } x_2(x_1 + y) \geq x_1(x_2 - x). \end{aligned}$$

So maximum occurs when  $x_1$  is as large as possible i.e.,  $x_2$  is as small as possible;  $x_2 = x$ . So  $x_1^p = 2^p - x^p = 2y^p \Rightarrow x_1 = 1$ . Therefore;  $\|b - \underline{x}\|_p \leq 2$ .

**CASE 4.4 :**  $x_1, x_2 \geq 0, x_3 \leq 0$  and  $x_2 > x$ ,  $x_1 < y$  and  $x_3 > -y$  we have

$$\|b - \underline{x}\|^p = (x_1 + y)^p + (x_2 - x)^p + (x_3 + y)^p.$$

If we increase  $x_3$  to 0 and increase  $x_1$  and  $x_2$  subject to  $x_1 < y$ , we have

$$\|b - \underline{x}\|^p \leq (x_1 + y)^p + (x_2 - x)^p + y^p.$$

We know that  $x_2 > x$  and  $x_1 < y$ , and,  $x_1^p + x_2^p = 2^p$ . As in case 1.5, we have  $\|b - \underline{x}\|_p \leq 2$ .

So cases 4.3 and 4.4 show that for  $x_1, x_2 > 0$ ,  $x_3 < 0$  and  $x_2 > x$ ,  $\|b - x\|_p \leq 2$ . So the facet determined by  $(-2, 0, 0)$ ,  $(0, 2, 0)$ ,  $(0, 0, 2)$  is covered. By symmetry, the facet  $(2, 0, 0)$ ,  $(0, -2, 0)$ ,  $(0, 0, -2)$  is also covered. This completes the proof of theorem 1.2.  $\square$

In Euclidean 3-space  $\mathbb{R}^3$  with a Cartesian coordinate system  $(x_1, x_2, x_3)$ , let  $\mathfrak{B}_1$  be the octahedron defined by  $|x_1| + |x_2| + |x_3| \leq 1$ , i.e., the convex hull of the following six points;  $(\mp 1, 0, 0)$ ,  $(0, \mp 1, 0)$ ,  $(0, 0, \mp 1)$ .

In order to prove  $B_1(\mathfrak{B}_1) = 6$ , we show that both  $B_1(\mathfrak{B}_1) \geq 6$  and  $B_1(\mathfrak{B}_1) \leq 6$  hold.

First we prove that  $B_1(\mathfrak{B}_1) \geq 6$  holds. Let  $\mathfrak{X}$  be a blocking set of  $\mathfrak{B}_1$ . If we repeat the arguments in the proof of Theorem 2 of L. Dalla, D. G. Larman, P. Mani-Levitska and C. Zong [4], we obtain that

$$\partial(2\mathfrak{B}_1) \subset \bigcup_{x \in \mathfrak{X}} \text{int}(2\mathfrak{B}_1 + x).$$

Since each translate of  $\text{int}(2\mathfrak{B}_1)$  contains at most one vertex of  $2\mathfrak{B}_1$ , it follows that  $B_1(\mathfrak{B}_1) \geq 6$ . From the above theorem 1.2, we know  $B_1(\mathfrak{B}_1) \leq 6$ . Consequently, we have  $B_1(\mathfrak{B}_1) = 6$ .

For the 4-dimensional unit  $\ell_p^4$  ball,

$$B_1(\mathfrak{B}_p^4) \leq 16$$

can also be proven by repeating the proof of the theorem 1.3. For  $p = \infty$ ,  $\mathfrak{B}_p^4$  is the unit Euclidean 4-cube and  $B_1(\mathfrak{B}_\infty^4) = 16$  was proved by L. Dalla, D. G. Larman, P. Mani-Levitska and C. Zong [4]. In fact,  $B_1(\mathfrak{B}_\infty^n) = 2^n$  is proven for the  $n$ -dimensional  $\ell_\infty$  balls in the same paper. The main result of the paper is  $B_1(\mathfrak{B}_2^4) = 9$ .

Unlike the ball, the sections of the unit  $\ell_p^n$  ball have a different character. Therefore; we can not generalize them for  $n$ -dimensions as easily as the ball, i.e., by taking their  $(n - 1)$ -dimensional section, working out the blocking arrangement and generalizing it for  $n$ -dimensions. We have the following conjecture for generalized blocking number without restrictions,  $B_1(\cdot)$ :

**Conjecture 1.3.1** *For every  $n$ -dimensional convex body  $\mathcal{K}$ , the unrestricted blocking number satisfies*

$$2n \leq B_1(\mathcal{K}) \leq 2^n.$$



## 1.4 The Similarities between $B'_\alpha$ and $B_\alpha$

We note immediately that the connection between generalized blocking number and the unrestricted blocking number has an elegance that is rooted in the very simplicity of their explanations. However; the results are not trivial. Even in 3–dimensions, it is not proven yet that  $B_\alpha(\mathcal{K}) = B'_\alpha(\mathcal{K})$ . On the other hand, by K. Böröczky Jr., D. G. Larman, S. Sezgin, C. M. Zong [2], we have the following result:

**Theorem 1.3** *Let  $I_n$  be  $n$ -dimensional cube. If  $0 < \alpha \leq 1/2$ , then*

$$B_\alpha(I_n) = B'_\alpha(I_n) = \begin{cases} 2(k+1)^n - 2k^n & \text{if } \frac{1}{2k+1} < \alpha \leq \frac{1}{2k}, \\ 2n(k+1)^{n-1} & \text{if } \frac{1}{2k+2} < \alpha \leq \frac{1}{2k+1}. \end{cases}$$

In order to prove 1.3, we study  $B_\alpha(I_n)$ , the similar number without the restrictions of the pairwise non-overlapping and touching the original body  $I_n$ . Clearly we have

$$B'_\alpha(I_n) \leq B'_\beta(I_n) \tag{1.16}$$

and

$$B_\alpha(I_n) \leq B_\beta(I_n) \tag{1.17}$$

for  $0 < \beta \leq \alpha$ , and

$$B_\alpha(I_n) \leq B'_\alpha(I_n). \tag{1.18}$$

For the rest of the proof, we can assume that the homothetic copies  $\alpha I_n + x$ 's touch the body  $I_n$ . Since for  $n$ -dimensional parallelotope  $I_n$ , we need to block the vertices, we place the copies close to the vertices but not necessarily touching them.

In addition, according to an observation of Zong [3] (see also [6]), to prove  $\alpha I_n + X$  is a blocking configuration it is sufficient to prove

$$\partial((1 + \alpha)I_n) \subset \bigcup_{\mathbf{x} \in X} (\text{int}(2\alpha I_n) + \mathbf{x})$$

where  $X$  is the blocking set. Thus, we have

$$B_\alpha(I_n) = G_\alpha(I_n), \quad (1.19)$$

where  $G_\alpha(I_n)$  indicates the smallest number of translates  $\text{int}(2\alpha I_n) + \mathbf{x}$ ,  $\mathbf{x} \in \partial((1+\alpha)I_n)$ , which can cover  $\partial((1+\alpha)I_n)$ . It is clear that, for  $0 < \beta \leq \alpha$ ,

$$G_\alpha(I_n) \leq G_\beta(I_n). \quad (1.20)$$

Now we introduce three technical lemmas.

**Lemma 1.4.1** *Let  $\alpha$  be a positive number such that  $\alpha \leq 1/2$ , and let  $m$  be the smallest integer such that  $m\alpha > 1 + \alpha$ , i.e.  $\alpha > 1/(m-1)$ . Then,*

$$G_\alpha(I_n) = G_\beta(I_n)$$

for  $\alpha \geq \beta > 1/(m-1)$ .

**Proof of 1.4.1.** Let  $X$  be a set of points such that

$$\partial((1+\alpha)I_n) \subset \bigcup_{\mathbf{x} \in X} (\text{int}(2\alpha I_n) + \mathbf{x}),$$

and let  $\epsilon$  be a small positive number. Without loss of generality, we assume that  $X$  belong to the union of the interiors of the  $2n$  facets of  $(1+\alpha)I_n$ . Denote by  $F$  the interior of the facet  $\{\mathbf{x} \in (1+\alpha)I_n : x_n = (1+\alpha)/2\}$ , and write

$$\Phi = \partial((1+\alpha)I_n) \setminus \{F \cup \{-F\}\}$$

and

$$X^* = \{\mathbf{x} \in X : \Phi \cap \text{int}(2\alpha I_n + \mathbf{x}) \neq \emptyset\}.$$

Furthermore, we write

$$I(\mu, \nu) = \{\mathbf{x} : |x_i| \leq \mu \text{ for } 1 \leq i \leq n-1; -\mu \leq x_n \leq \nu\},$$

$$\mathbf{u} = (0, 0, \dots, 0, -1),$$

and enumerate the points of  $X^* \setminus F$  as  $\mathbf{x}_1, \mathbf{x}_2, \dots, \mathbf{x}_l$  (where  $\mathbf{x}_i = (x_{i,1}, x_{i,2}, \dots, x_{i,n})$ ) such that

$$x_{i+1,n} \leq x_{i,n}$$

for all  $i = 1, 2, \dots, l-1$ . Now we introduce an inductive process to adjust two points of  $X^* \setminus F$ .

First, let  $r_1$  be the maximum of the numbers  $r$  such that

$$\Phi \subset \text{int}(I(\alpha, \alpha - \epsilon) + \mathbf{x}_1 + r\mathbf{u}) \cup \bigcup_{\mathbf{x} \in X^* \setminus \{\mathbf{x}_1\}} (\text{int}(2\alpha I_n) + \mathbf{x}).$$

Then, replace  $\mathbf{x}_1$  by  $\mathbf{x}_1 + r_1\mathbf{u}$ . Assume that the first  $i-1$  points of  $X^* \setminus F$  have been adjusted, and assume that  $r_i$  is the maximum of the numbers  $r$  such that

$$\Phi \subset \text{int}(I(\alpha, \alpha - \epsilon) + \mathbf{x}_i + r\mathbf{u}) \cup \bigcup_{\mathbf{x} \in X^* \setminus \{\mathbf{x}_i\}} (\text{int}(2\alpha I_n) + \mathbf{x}),$$

where  $X^*$  is the updated set for the first  $i-1$  steps. Then replace  $\mathbf{x}_i$  by  $\mathbf{x}_i + r_i\mathbf{u}$ . After  $l$  steps we obtain a new set  $X^*$ .

This process produces many chains

$$\mathbf{x}_{j_1}, \mathbf{x}_{j_2}, \dots, \mathbf{x}_{j_{f(j)}}$$

in  $X^*$  such that  $x_{j_1,n} = (1 + \alpha)/2$  or  $(1 - \alpha)/2 + \epsilon$ ,

$$x_{j_{i-1},n} - x_{j_i,n} = 2\alpha - \epsilon$$

for  $2 \leq i \leq f(j)$ , and

$$(\text{int}(2\alpha I_n) + \mathbf{x}_{j_{f(j)}}) \cap \{-F\} \neq \emptyset.$$

In addition, every point  $\mathbf{x} \in X^*$  with  $\{-F\} \cap \text{int}(2\alpha I_n + \mathbf{x}) \neq \emptyset$  is the last point of some of these chains. Thus, for the new  $X^*$ ,

$$\bigcup_{\mathbf{x} \in X^*} \text{int}(2\alpha I_n + \mathbf{x})$$

covers the corresponding  $\Phi$  of

$$P = \left\{ \mathbf{x} : |x_i| \leq \frac{1+\alpha}{2} \text{ for } 1 \leq i \leq n-1; \right. \\ \left. \frac{1+\alpha}{2} - m\alpha + l\epsilon \leq x_n \leq \frac{1+\alpha}{2} \right\}.$$

This rectangular parallelepiped has height  $m\alpha - l\epsilon$  in the direction of  $\mathbf{u}$ . We define

$$x'_{i,n} = \begin{cases} \frac{1+\beta}{2} & \text{if } \mathbf{x}_i \in X \cap F, \\ -\frac{1+\beta}{2} & \text{if } \mathbf{x}_i \in X \cap \{-F\}, \\ \frac{1+\beta}{2} + \frac{\beta}{\alpha}(x_{i,n} - \frac{1+\beta}{2}) & \text{if } \mathbf{x}_i \in X \setminus \{F \cup \{-F\}\}, \end{cases}$$

and the corresponding set

$$X' = \{(x'_{i,1}, x'_{i,2}, \dots, x'_{i,n}) : x'_{i,j} = x_{i,j} \text{ for } 1 \leq j \leq n-1\}.$$

It can be verified that

$$\partial((1+\beta)I_n) \subset \text{int}(I(\alpha, \beta) + X').$$

Repeating this process with respect to all coordinates, proves Lemma 1.4.1.  $\square$

**Lemma 1.4.2** *Let  $k$  be a positive integer, then*

$$G_\alpha(I_n) \geq \begin{cases} 2(k+1)^n - 2k^n & \text{if } \alpha = \frac{1}{2k}, \\ 2n(k+1)^{n-1} & \text{if } \alpha = \frac{1}{2k+1}, \end{cases}$$

**Proof of 1.4.2.** We deal with the two cases by different methods.

**Case 1.**  $\alpha = 1/2k$ . In this case we proceed to choose a centrally symmetric set  $Y_n \subset \partial((1+\alpha)I_n)$  such that

$$\text{card}\{Y_n\} = 2(k+1)^n - 2k^n$$

and, for any  $\mathbf{x} \in \partial((1 + \alpha)I_n)$ ,  $\text{int}(2\alpha I_n) + \mathbf{x}$  contains at most one point of  $Y_n$ . For this purpose we apply induction on dimension. As usual, we use  $\mathbf{e}_i$  to indicate the  $i$ -th normalized basis vector.

When  $n = 2$ , writing  $\mathbf{v} = -((1 + \alpha)/2, (1 + \alpha)/2)$ ,

$$Y_2^* = \{\mathbf{v} + 2j\alpha\mathbf{e}_1 : 0 \leq j \leq k\},$$

$$Y_2^\star = \{\mathbf{v} + 2j\alpha\mathbf{e}_2 : 1 \leq j \leq k\},$$

and

$$Y_2 = Y_2^* \cup Y_2^\star \cup \{-Y_2^*\} \cup \{-Y_2^\star\},$$

it can be verified that  $Y_2$  satisfies the conditions.

Assuming that the assertion is true in  $E^{n-1}$ , we proceed to prove it for  $E^n$ . In  $E^n$ , we take

$$\mathbf{v} = -\left(\frac{1+\alpha}{2}, \frac{1+\alpha}{2}, \dots, \frac{1+\alpha}{2}, 0\right),$$

$$F = \{\mathbf{x} \in (1 + \alpha)I_n : x_n = 0\},$$

and let  $Y_{n-1}$  be the set corresponding to  $F$ . Then, divide  $Y_{n-1}$  into two disjoint sets  $Y_{n-1}^*$  and  $Y_{n-1}^\star$  such that the first belongs to the facets of  $F$  which contain  $\mathbf{v}$ , the second belongs to the facets of  $F$  which contain  $-\mathbf{v}$ , and

$$Y_{n-1}^* = -Y_{n-1}^\star.$$

Now, we define

$$Y_n^* = \{\mathbf{y} + \left(\frac{\alpha-1}{2} + 2j\alpha\right)\mathbf{e}_n : 0 \leq j \leq k-1, \mathbf{y} \in Y_{n-1}^*\},$$

$$Y_n' = \{\mathbf{y} : y_n = -\frac{1+\alpha}{2}, y_i = \frac{1+\alpha}{2} - 2j\alpha, 0 \leq j \leq k \text{ for } i \neq n\},$$

and

$$Y_n = Y_n^* \cup Y'_n \cup \{-Y_n^*\} \cup \{-Y'_{n-1}\}.$$

It can be verified that, for any point  $\mathbf{x} \in \partial((1 + \alpha)I_n)$ , the set  $\text{int}(2\alpha I_n) + \mathbf{x}$  contains at most one point of  $Y_n$ ,

$$\text{card}\{Y_n^* \cup \{-Y_n^*\}\} = 2k((k+1)^{n-1} - k^{n-1}),$$

$$\text{card}\{Y'_n\} = (k+1)^{n-1},$$

and therefore

$$\text{card}\{Y_n\} = 2(k+1)^{n-1} + 2k((k+1)^{n-1} - k^{n-1}) \quad (1.21)$$

$$= 2(k+1)^n - 2k^n. \quad (1.22)$$

Case 1 follows.

**Case 2.**  $\alpha = 1/(2k+1)$ . For convenience, we write

$$F_i = \{\mathbf{x} : x_i = \frac{1+\alpha}{2}, |x_j| \leq \frac{1-\alpha}{2}, j \neq i\},$$

$$X_i = \{\mathbf{x} \in X : (\text{int}(2\alpha I_n) + \mathbf{x}) \cap F_i \neq \emptyset\}$$

and

$$X_{n+i} = \{\mathbf{x} \in X : (\text{int}(2\alpha I_n) + \mathbf{x}) \cap \{-F_i\} \neq \emptyset\}.$$

It can be verified that

$$X_i \cap X_j = \emptyset$$

for  $1 \leq i < j \leq 2n$ , and

$$\text{card}\{X_j\} \geq \left\lfloor \frac{1-\alpha}{2\alpha} + 1 \right\rfloor^{n-1} = (k+1)^{n-1}.$$

Thus, we have

$$\text{card}\{X\} = \sum_{i=1}^{2n} \text{card}\{X_i\} \geq 2n(k+1)^{n-1},$$

which proves the second case.

This proves Lemma 1.4.2.  $\square$

**Lemma 1.4.3**  $B'_\alpha(I_n) \leq \begin{cases} 2(k+1)^n - 2k^n & \text{if } \frac{1}{2k+1} < \alpha \leq \frac{1}{2k}, \\ 2n(k+1)^{n-1} & \text{if } \frac{1}{2k+2} < \alpha \leq \frac{1}{2k+1}. \end{cases}$

**Proof of 1.4.3.** We deal with the two cases with different methods.

**Case 1.**  $1/(2k+1) < \alpha \leq 1/2k$ . In this case we apply induction on the dimensions. Clearly, the assertion is true when  $n = 1$ . Assume it is true for  $n - 1$ , and  $\alpha I_{n-1} + X_{n-1}$  is an optimal blocking configuration. Let  $\epsilon$  be a small positive number, and define

$$X_n^* = \bigcup_{j=0}^{k-1} \left( X_{n-1} + \left( \frac{1-3\alpha+2\epsilon}{2} - j \frac{1-3\alpha+2\epsilon}{k-1} \right) \mathbf{e}_n \right),$$

$$X_n^\star = \left\{ \mathbf{x} : x_n = \frac{1+\alpha}{2}, x_i = \frac{(k-2j)(2\alpha-\epsilon)}{2} \text{ for } 0 \leq j \leq k \right\},$$

and

$$X_n = X_n^* \cup X_n^\star \cup \{-X_n^\star\}.$$

It can be verified that  $\alpha I_n + X_n$  is a blocking configuration and

$$\text{card}\{X_n\} = 2(k+1)^n - 2k^n.$$

Thus, in this case,

$$B'_\alpha(I_n) \leq 2(k+1)^n - 2k^n.$$

**Case 2.**  $1/(2k+2) < \alpha \leq 1/(2k+1)$ . We proceed to show that there is a centrally symmetric set  $X$  of  $2n(k+1)^{n-1}$  points such that  $\alpha I_n + X$  is a packing,  $\text{int}(I_n) \cap (\alpha I_n + X) = \emptyset$ , and  $\alpha I_n + X$  can block any other translate of  $\alpha I_n$  from touching  $I_n$ . It is clear

that the assertion is true when  $n = 1$ . Assuming that it is true in  $E^{n-1}$ , we consider  $E^n$ .

In  $E^n$  we write

$$v = \left( \frac{1+\alpha}{2}, \frac{1+\alpha}{2}, \dots, \frac{1+\alpha}{2}, 0 \right), \quad (1.23)$$

$$I_{n-1} = \{\mathbf{x} \in I_n : x_n = 0\},$$

and let  $X_{n-1}$  be a corresponding optimal set. Similar to the first case of Lemma 1.4.2, we divide  $X_{n-1}$  into  $X_{n-1}^*$  and  $X_{n-1}'$  corresponding to  $\mathbf{v}$  and  $-\mathbf{v}$ , respectively. Thus, let  $\epsilon$  be a small positive number and define

$$X_n^* = \{\mathbf{x} + [j \frac{1-2\alpha+\epsilon}{k} - \frac{1}{2}(1-\alpha+\epsilon)] \mathbf{e}_n : \mathbf{x} \in X_{n-1}^*, 0 \leq j \leq k\},$$

$$X_n' = \{\mathbf{x} : x_n = \frac{1+\alpha}{2}, x_i = j \frac{1-2\alpha+\epsilon}{k} - \frac{1}{2}(1-3\alpha+\epsilon), 0 \leq j \leq k\},$$

and

$$X_n = X_n^* \cup X_n' \cup \{-X_n^*\} \cup \{-X_n'\},$$

it can be verified that  $X_n$  satisfies the requirement. Thus, in this case, we have

$$B'_\alpha(I_n) \leq \text{card}\{X_n\} = 2(\text{card}\{X_n^*\} + \text{card}\{X_n'\}) \quad (1.24)$$

$$= 2n(k+1)^{n-1}. \quad (1.25)$$

This estimate finally completes the proof of Lemma 1.4.3.  $\square$

Now Theorem 1.3 follows from (1.16)-(1.20), and the three lemmas.

In keeping with our primary aim, we turn to the study of blocking number. Like generalized blocking number, if the blocking number is studied without restrictions then it turns out that blocking number also has similarities with the unrestricted blocking



number. Namely; in 3–dimensions, based on the proof of Theorem 2 in L. Dalla, D. G. Larman, P. Mani-Levitska and C. Zong [4], an upper bound for the unrestricted blocking number,  $B_1(\mathcal{K})$ , will be given in Theorem 1.4.

First, we shall give the definition of M–curvature  $m(\cdot)$  as follows: Let  $\mathcal{C}$  be a centrally symmetric convex body in  $\mathbb{R}^n$  centered at  $\underline{O}$ . We denote the manifold

$$\Omega := \{[x, y] : x, y \in \partial\mathcal{C} \text{ and } \|x, y\| = 1\}.$$

Furthermore; we denote the straight line passing  $\underline{x}$  and  $\underline{y}$  by  $L(\underline{x}, \underline{y})$ , the two dimensional plane passing  $\underline{O}$ ,  $\underline{x}$  and  $\underline{y}$  by  $P(\underline{x}, \underline{y})$  and tangent of  $\mathcal{C} \cap P(\underline{x}, \underline{y})$  which is parallel to  $L(\underline{x}, \underline{y})$  and at the same side of  $\underline{O}$  with  $L(\underline{x}, \underline{y})$  by  $T(\underline{x}, \underline{y})$ .

Let

$$m(\mathcal{C}) = \min_{[x, y] \in \Omega} \left( 1 - \frac{d(\underline{O}, L(\underline{x}, \underline{y}))}{d(\underline{O}, T(\underline{x}, \underline{y}))} \right)$$

where  $d(X, Y)$  indicates the Euclidean distance.

**Theorem 1.4** *Let  $\mathcal{C}$  be an  $n$ –dimensional centrally symmetric convex body with M–curvature  $m(\mathcal{C})$ , then*

$$B_1(\mathcal{C}) \geq \frac{1}{n^{\frac{3}{2}}} (1 - m(\mathcal{C}))^{2-n}.$$

## 1.5 The Differences between $B$ and $B_\alpha$

The difference body of any convex body  $\mathcal{K}$ , is denoted by  $D\mathcal{K}$  and is defined to be the set of all points  $x - y$  where  $x$  and  $y$  belong to  $\mathcal{K}$ . In the paper of L. Dalla,

D. G. Larman, P. Mani-Levitska and C. M. Zong [4], it has been pointed out that we may confine ourselves to the centrally symmetric case whenever we deal with the kissing numbers and the blocking numbers of convex bodies since  $B(\mathcal{K}) = B(D\mathcal{K})$ . This property simplifies some related problems since the centrally symmetric bodies are easier to handle.

However, as will be shown in the next two theorems, there are some examples that  $N_\alpha(\mathcal{K})$  and  $B_\alpha(\mathcal{K})$  can be both smaller or larger than  $N_\alpha(D\mathcal{K})$  and  $B_\alpha(D\mathcal{K})$  respectively. So the above property does not hold for the unrestricted blocking number, i. e.,  $B_\alpha(\mathcal{K}) = B_\alpha(D\mathcal{K})$  is not always true.

Now we give definition of Reuleaux polygon and triangle. The width of a convex curve in a given direction is the distance between a pair of supporting lines of the curve perpendicular to this direction. If the width of a curve is the same in all directions, then it is called a *curve of constant width*. Thus a closed ball of radius  $r$  has constant width  $2r$ . There are convex bodies of constant width other than closed balls. The simplest of these is the *Reuleaux triangle*. This is a plane figure obtained by intersecting three closed circular discs of radius  $a$  centred at the vertices of an equilateral triangle with sides of length  $a$ . The Reuleaux triangle can be generalized to regular polygons with an odd number of sides. Reuleaux pentagons, heptagons, nonagons etc. can be constructed in a similar way. *Reuleaux polygons* necessarily have an odd number of sides since given any two parallel supporting lines of a Reuleaux polygon, one of them passes through some vertex of the polygon of side  $a$ , while the other is tangent to the opposite circular arc; hence the distance between two parallel supporting lines of a Reuleaux polygon is  $a$ . This only occurs when the polygon has odd number of sides. Briefly, all points on a curved side are equidistant from the opposite vertex. For details on these matters see [5].

**Theorem 1.5** *Let  $\mathcal{P}$  be any Reuleaux polygon with  $k$  vertices where  $k \geq 5$  is an odd number and diameter 1. Let  $\mathcal{T}$  be any Reuleaux triangle in  $\mathbb{R}^2$  with diameter 1. If the scaling factor of the homothetic copy of  $D\mathcal{P}$  (and  $DT$ ) is  $\alpha_k$  (and  $\alpha_l$ ), where  $\alpha_k$  (and  $\alpha_l$ ) satisfies*

$$1 > \alpha_h > \frac{\sin \frac{\pi}{h}}{2 \sin \frac{(h-1)\pi}{2h} - \sin \frac{\pi}{h}},$$

where  $h=k$  or  $l$  respectively then

$$(i) \quad B_{\alpha_k}(\mathcal{P}) > B_{\alpha_k}(D\mathcal{P}) = k \quad \text{where } k = 5, 7, 9, \dots$$

$$(ii) \quad B_{\alpha_l}(\mathcal{T}) < B_{\alpha_l}(DT) = l \quad \text{where } l = 6, 9, 12, \dots$$

Here we define  $B_{\alpha_h}(\mathcal{K})$  as the unrestricted blocking number, i.e. the translates of  $\alpha_h\mathcal{K}$  are allowed to overlap and are not necessarily in contact with  $\mathcal{K}$  but they are not allowed to meet int  $\mathcal{K}$ .

### Proof of 1.5

(i) Let  $\mathcal{P}$  be any Reuleaux polygon of diameter 1 with vertices  $v_i$  ( $i = 1, \dots, k$ ), in  $\mathbb{R}^2$  where  $k$  is an odd number with  $k \geq 5$ . Note that  $\mathcal{P}$  is a convex body with constant width 1. So the positive number  $\alpha_k$  is the constant width of the homothetic copy  $\alpha_k\mathcal{P}$  of  $\mathcal{P}$ .

We know that the sum of an arbitrary convex curve of constant width 1 with the same curve turned through  $180^\circ$ , i.e.,  $\mathcal{P} + (-\mathcal{P})$  is a circle of radius 1. Hence  $D\mathcal{P}$  is the unit circle.

Here  $\alpha_k$  is chosen so that  $B_{\alpha_k}(D\mathcal{P}) = k$ . Let  $\alpha_k D\mathcal{P} + x_i$ ,  $i = 1, \dots, k$  be a corresponding blocking set. The blocking set can be assumed to be equally distributed around the

circle  $D\mathcal{P}$ . Let  $u_i$  be the touching point of  $\alpha_k D\mathcal{P} + x_i$  to  $D\mathcal{P}$ . Then, the  $u_i$ 's are the vertices of a regular polygon  $\mathcal{K}$  in  $D\mathcal{P}$ . Let  $d_i$  be the distance between  $u_i$  and  $u_{i+1}$ . Since  $\mathcal{K}$  is a regular polygon, all  $d_i$ 's are equal.

We now calculate the values of  $\alpha_k$ . We take the midpoint of the minor arc  $\widehat{x_i x_{i+1}}$  on the boundary of  $(1 + \alpha_k)D\mathcal{P}$  as a reference point and call it  $z_i$ , with  $z_k$  on the arc  $\widehat{x_k x_1}$ .

Let  $2a$  be the distance between  $x_i$  and  $x_{i+1}$  and  $b$  be the distance between  $x_i$  and  $z_i$ . As can be seen from figure 1.7.1,

$$a = b \sin \frac{(k-1)\pi}{2k}.$$

Since  $B_{\alpha_k}(D\mathcal{P}) = k$  we must have  $b < 2\alpha_k$ . This is because the translate,  $\alpha_k D\mathcal{P} + z_i$  of  $\alpha_k D\mathcal{P}$ , which touches  $D\mathcal{P}$  must overlap both  $\alpha_k D\mathcal{P} + x_i$  and  $\alpha_k D\mathcal{P} + x_{i+1}$ ; so  $b < 2\alpha_k$  must hold.

From  $b < 2\alpha_k$  and  $a = b \sin \frac{(k-1)\pi}{2k}$ , we have the following lower bound for  $\alpha_k$ .

$$\begin{aligned} a &= (1 + \alpha_k) \sin \frac{\pi}{k} \\ (1 + \alpha_k) \sin \frac{\pi}{k} &= b \sin \frac{(k-1)\pi}{2k} < 2\alpha_k \sin \frac{(k-1)\pi}{2k} \\ \implies \alpha_k &> \frac{\sin \frac{\pi}{k}}{2 \sin \frac{(k-1)\pi}{2k} - \sin \frac{\pi}{k}}. \end{aligned}$$

So, if  $B_{\alpha_k}(D\mathcal{P}) = k$ , then we must choose  $\alpha_k > \frac{\sin \frac{\pi}{k}}{2 \sin \frac{(k-1)\pi}{2k} - \sin \frac{\pi}{k}}$ .

As  $k \geq 5$ , we are able to choose  $\alpha_k$  with

$$1 > \alpha_k > \frac{\sin \frac{\pi}{k}}{2 \sin \frac{(k-1)\pi}{2k} - \sin \frac{\pi}{k}}.$$

Now, we will prove that

$$B_{\alpha_k}(\mathcal{P}) > k \text{ where } k = 5, 7, 9, \dots \text{ for } \alpha_k > \frac{\sin \frac{\pi}{k}}{2 \sin \frac{(k-1)\pi}{2k} - \sin \frac{\pi}{k}} \text{ as calculated above.}$$

If  $\{\alpha_k \mathcal{P} + y_i\}_{i=1}^k$  is an  $\alpha_k$  blocking set for  $\mathcal{P}$  then, from the definition of the unrestricted blocking number,  $B_{\alpha_k}(\mathcal{P})$  we must have:

$$\text{int } \mathcal{P} \cap \text{int } (\alpha_k \mathcal{P} + y_i) = \emptyset \text{ for all } i$$

If  $\mathcal{P} \cap (\alpha_k \mathcal{P} + y) \neq \emptyset$  and  $\text{int } \mathcal{P} \cap \text{int } (\alpha_k \mathcal{P} + y) = \emptyset$ , then

$$\exists \alpha_k \mathcal{P} + y_i \text{ such that } \text{int } (\alpha_k \mathcal{P} + y) \cap \text{int } (\alpha_k \mathcal{P} + y_i) \neq \emptyset.$$

Here it can be assumed that

$$\partial \mathcal{P} \cap \partial (\alpha_k \mathcal{P} + y_i) \neq \emptyset \text{ for all } i.$$

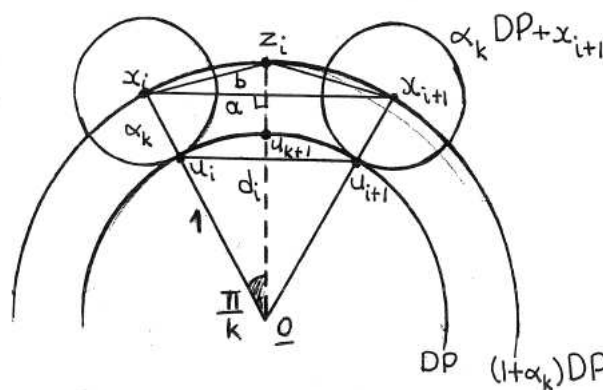

Figure 1.5.1

since the homothetic copies of  $\mathcal{P}$  can be placed such that they do not touch  $\mathcal{P}$  and this does not change the following proof of the theorem. The proof depends on the positions of the homothetic copies relative to each other; it does not depend on whether they touch  $\mathcal{P}$  or not.

Since we have  $k$  vertices of  $\mathcal{P}$  and  $k$  members of our blocking set, for each vertex, it might seem appropriate to place a translate of  $\alpha_k \mathcal{P}$  touching  $\mathcal{P}$  on this vertex.

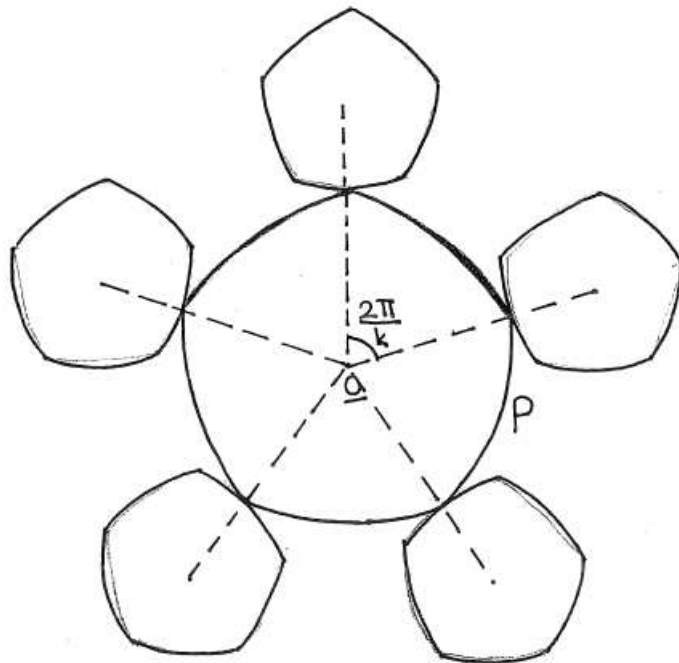

Figure 1.5.2

We should emphasize that this configuration is not the general case. The translates might be placed anywhere around the boundary of  $\mathcal{P}$ . Let  $\alpha_k \mathcal{P} + y_m$  be another disjoint homothetic copy of  $\mathcal{P}$  from the other homothetic copies,  $\alpha_k \mathcal{P} + y_i$ 's. Here we need to prove that it is possible to insert  $\alpha_k \mathcal{P} + y_m$  which touches  $\mathcal{P}$  or relatively close to  $\mathcal{P}$

whenever  $k$  homothetic copies  $\alpha_k \mathcal{P} + y_i$ 's ( $i = 1, \dots, k$ ) are placed around  $\partial \mathcal{P}$  with all the other properties of a blocking set and  $\text{int}(\alpha_k \mathcal{P} + y_m) \cap \text{int}(\alpha_k \mathcal{P} + y_i) = \emptyset$ ,  $i = 1, \dots, k$ .

We look for a pair of consecutive homothetic copies ordered anticlockwise from the centre of  $\mathcal{P}$  to the centre of  $\alpha_k \mathcal{P} + y_i$ , so that we can put a disjoint copy  $\alpha_k \mathcal{P} + y_m$  which touches  $\mathcal{P}$  between this pair,  $\alpha_k \mathcal{P} + y_i$  and  $\alpha_k \mathcal{P} + y_{i+1}$ . There must exist a pair  $\alpha_k \mathcal{P} + y_i$  and  $\alpha_k \mathcal{P} + y_{i+1}$  such that the angle  $\beta_i$  subtended at the centre  $\underline{O}$  is at least  $\frac{2\pi}{k}$ , i.e.,

$$\beta_i \geq \frac{2\pi}{k},$$

and we consider this pair. (Since it is more likely that a disjoint copy  $\alpha_k \mathcal{P} + y_m$  can be placed between two homothetic copies  $\alpha_k \mathcal{P} + y_i$  and  $\alpha_k \mathcal{P} + y_{i+1}$  such that the angle  $\beta_i$  between them is at least  $\frac{2\pi}{k}$ ).

Here the configuration of the pair can be chosen in many ways; however one can reduce them to three cases. The other possible cases will be explained in the corresponding cases given below. So there are three distinct ways to put the pair around the boundary:

1. Both  $\alpha_k \mathcal{P} + y_i$  and  $\alpha_k \mathcal{P} + y_{i+1}$  touch  $\mathcal{P}$  at its vertices,  $v_i$  and  $v_{i+1}$  respectively. We shall also consider the intuitively less likely case that they touch at  $v_i$  and  $v_{i+2}$  respectively.
2. Both  $\alpha_k \mathcal{P} + y_i$  and  $\alpha_k \mathcal{P} + y_{i+1}$  touch  $\mathcal{P}$  on its arcs, arc  $\widehat{v_i v_{i+1}}$  and arc  $\widehat{v_{i+1} v_{i+2}}$  respectively. Here we also consider the case that they touch on arc  $\widehat{v_i v_{i+1}}$  and arc  $\widehat{v_{i+2} v_{i+3}}$  respectively.
3. One of the pair  $\alpha_k \mathcal{P} + y_i$  touches  $\mathcal{P}$  at the vertex  $v_i$  and  $\alpha_k \mathcal{P} + y_{i+1}$  touches on the arc  $\widehat{v_i v_{i+1}}$ . Here we will also mention the case that while  $\alpha_k \mathcal{P} + y_i$  touches  $\mathcal{P}$  on the arc  $\widehat{v_i v_{i+1}}$ ,  $\alpha_k \mathcal{P} + y_{i+1}$  touches at  $v_{i+2}$ .

1. Let  $\underline{Q}$  be the centre of the circumscribed circle of  $\mathcal{P}$ . Let  $\{\alpha_k \mathcal{P} + y_1, \dots, \alpha_k \mathcal{P} + y_k\}$  be disjoint homothetic copies of  $\mathcal{P}$ . In this case, these homothetic copies are placed around  $\partial \mathcal{P}$  so that a pair of the copies,  $\alpha_k \mathcal{P} + y_i$  ( $\alpha_k \mathcal{P} + y_{i+1}$ ), which the angle  $\beta_i$  subtended at  $\underline{Q}$  is at least  $\frac{2\pi}{k}$ , touches  $\partial \mathcal{P}$  on its vertices and we define for which  $k$ 's it is possible to place the additional copy  $\alpha_k \mathcal{P} + y_m$  between the pair.

1 i. First we shall prove that both  $\alpha_k \mathcal{P} + y_i$  and  $\alpha_k \mathcal{P} + y_{i+1}$  touch  $\mathcal{P}$  at its vertices,  $v_i$  and  $v_{i+1}$  respectively. (See Figure 1.5.3). Here we will also show when  $\alpha_k \mathcal{P} + y_m$  touches  $\mathcal{P}$  on the midpoint of arc  $\widehat{v_i v_{i+1}}$ .

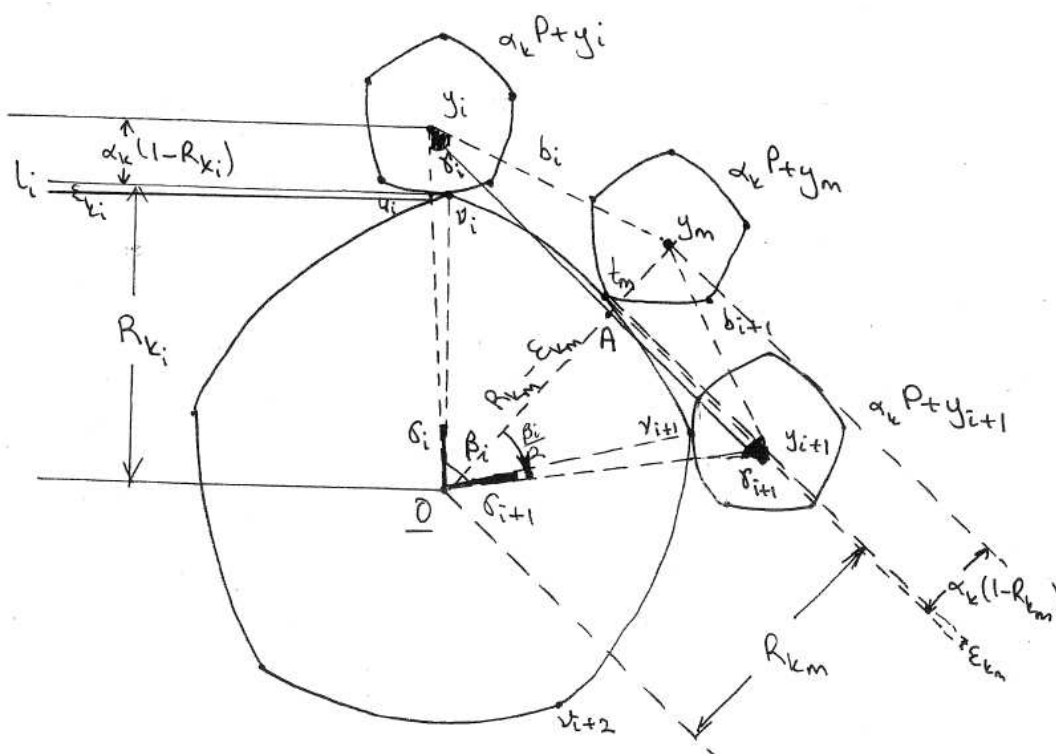

Figure 1.5.3



As explained at the beginning, the angle between  $\overrightarrow{Qv_i}$  and  $\overrightarrow{Qv_{i+1}}$  is  $\frac{2\pi}{k}$ . In general, we know that  $\alpha_k\mathcal{P} + y_i$  and  $\alpha_k\mathcal{P} + y_{i+1}$  might be placed so that  $y_i$  ( $y_{i+1}$ ) and  $v_i$  ( $v_{i+1}$ ) are not necessarily collinear with  $Q$ , i.e., there is an angle  $\sigma_i$  ( $\sigma_{i+1}$ ) between  $\overrightarrow{Qv_i}$  ( $\overrightarrow{Qv_{i+1}}$ ) and  $\overrightarrow{Qy_i}$  ( $\overrightarrow{Qy_{i+1}}$ ) respectively. (See Figure 1.5.3). So  $\beta_i \geq \frac{2\pi}{k}$  holds. Let  $\overrightarrow{QA}$  be the angular bisector of  $\beta_i$  so that  $A, y_i$  and  $y_{i+1}$  are collinear. Let  $y_m$  be a point on the ray from  $Q$  through  $A$  so that  $\alpha_k\mathcal{P} + y_m$  touches  $\mathcal{P}$  at  $t_m$ . If  $\sigma_i = 0 = \sigma_{i+1}$ , then  $Q, y_i$  and  $v_i$  are collinear. This will mean that  $\alpha_k\mathcal{P} + y_m$  is exactly in the middle of arc  $\widehat{(v_iv_{i+1})}$ . So this is a subcase of the case 1 i.

Let  $t_i$  be  $\partial\mathcal{P} \cap \partial(\alpha_k\mathcal{P} + y_i)$  ( $i = 1, \dots, k, m$ ) and  $u_i$  be  $\overrightarrow{Qy_i} \cap l_i$  where  $l_i$  is a tangent of  $\partial\mathcal{P}$  and  $l_i \perp \overrightarrow{Qy_i}$ . Here we should emphasize  $l_i$  is a tangent of  $\partial\mathcal{P}$  but not necessarily tangent to  $\alpha_k\mathcal{P} + y_i$ , i.e.,  $l_i \cap (\alpha_k\mathcal{P} + y_i) \neq \emptyset$  might hold as can be seen from Figure 1.5.3. Also note that since  $u_i = \overrightarrow{Qy_i} \cap l_i$  and  $t_i = \partial\mathcal{P} \cap \partial(\alpha_k\mathcal{P} + y_i)$  do not necessarily meet and where  $l_i$  meets  $\alpha_k\mathcal{P} + y_i$  is not important,  $l_i \perp \overrightarrow{Qy_i}$  can be chosen. Note that for this case,  $t_i = v_i$  and  $t_{i+1} = v_{i+1}$ . Here  $y_m$  is chosen so that  $t_m = \partial\mathcal{P} \cap \partial(\alpha_k\mathcal{P} + y_m)$  is on the arc  $\widehat{v_iv_{i+1}}$ . (See Figure 1.5.3).

Let  $R_{k_i}$  be the length of the vector  $\overrightarrow{Qu_i}$  where  $u_i = \overrightarrow{Qy_i} \cap l_i$ . Let  $\beta_i$  be the angle between the vectors  $\overrightarrow{Qy_i}$  and  $\overrightarrow{Qy_{i+1}}$ . Here it is important to note that since we deal with an arc, there might be a difference,  $\epsilon_{k_m} > 0$  between the touching point  $t_m$  and  $l_m$ . (See Figure 1.5.4).

Let  $b_i$  ( $b_{i+1}$ ) be the length of the vector  $\overrightarrow{y_iy_m}$  ( $\overrightarrow{y_{i+1}y_m}$ ) respectively. Furthermore, let  $\gamma_i$  ( $\gamma_{i+1}$ ) be the angle between  $\overrightarrow{Qy_i}$  ( $\overrightarrow{Qy_{i+1}}$ ) and  $\overrightarrow{y_iy_m}$  ( $\overrightarrow{y_{i+1}y_m}$ ). (See Figure 1.5.3).

We show that

$$\text{int}(\alpha_k\mathcal{P} + y_m) \cap \text{int}(\alpha_k\mathcal{P} + y_i) = \emptyset \quad (1.26)$$

$$\text{int}(\alpha_k\mathcal{P} + y_m) \cap \text{int}(\alpha_k\mathcal{P} + y_{i+1}) = \emptyset \quad (1.27)$$

while

$$\mathcal{P} \cap (\alpha_k \mathcal{P} + y_m) \neq \emptyset$$

$$\text{but } \text{int } \mathcal{P} \cap \text{int } (\alpha_k \mathcal{P} + y_m) = \emptyset.$$

Therefore,  $\text{int } (\alpha_k \mathcal{P} + y_m)$  will be another translate which touches  $\mathcal{P}$  and do not overlap any of  $\text{int } (\alpha_k \mathcal{P} + y_i)$ 's. So the  $k$  translates  $\alpha_k \mathcal{P} + y_1, \dots, \alpha_k \mathcal{P} + y_k$  are not enough to block  $\mathcal{P}$ .

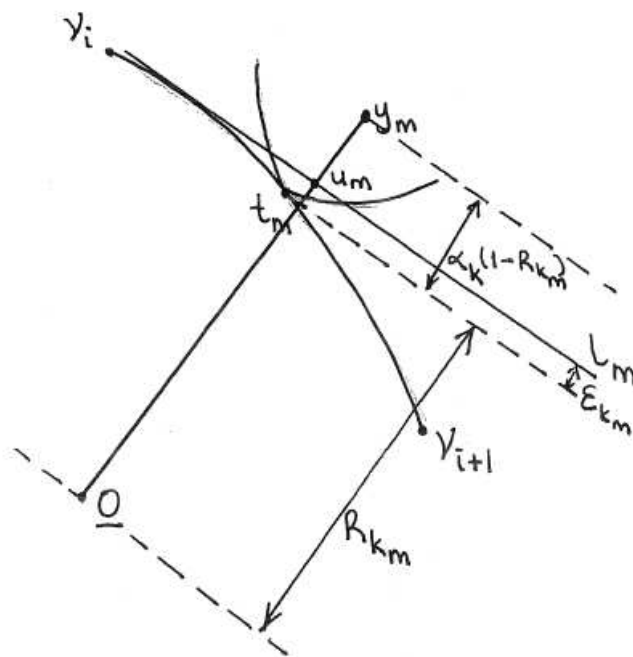

Figure 1.5.4

Let  $r_{k_i}$  be the smallest length between  $y_i$  and the tangent,  $n_i$  of  $\alpha_k \mathcal{P} + y_i$  where  $n_i$  is perpendicular to  $\overrightarrow{y_i y_m}$ . See Figure 1.5.5. Note that the smallest length between  $y_i$  and the opposite tangent,  $n'_i$  of  $\alpha_k \mathcal{P} + y_i$  is  $\alpha_k - r_{k_i}$ . As can be seen from the figure 1.5.3 and 1.5.5, if  $b_i > \alpha_k$  and  $b_{i+1} > \alpha_k$ , then

$$\begin{aligned} \text{int } (\alpha_k \mathcal{P} + y_m) \cap \text{int } (\alpha_k \mathcal{P} + y_i) &= \emptyset \\ \text{int } (\alpha_k \mathcal{P} + y_m) \cap \text{int } (\alpha_k \mathcal{P} + y_{i+1}) &= \emptyset \end{aligned}$$

both hold as in (1.26) and (1.27).

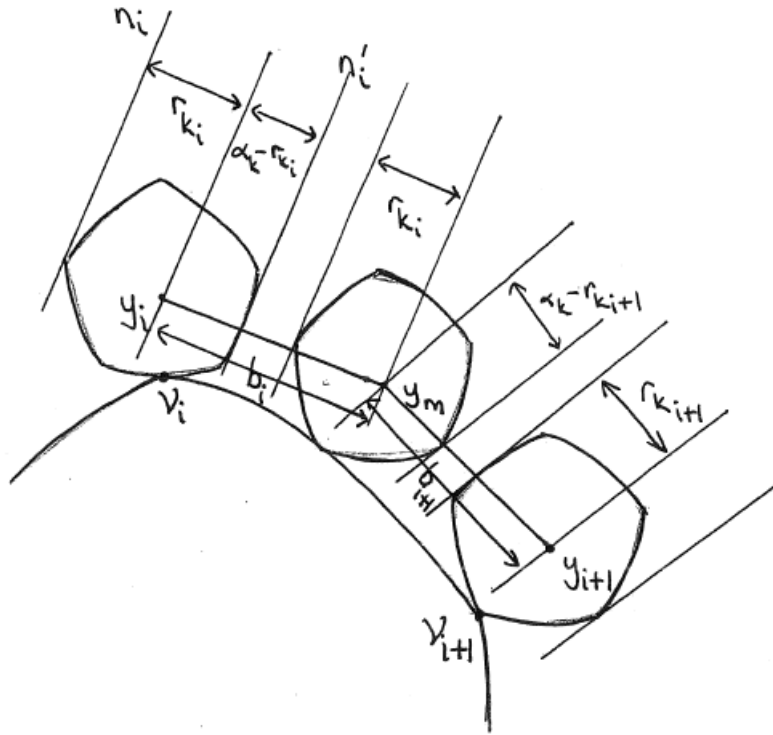

Figure 1.5.5

Only  $b_i > \alpha_k$  and  $b_{i+1} > \alpha_k$  are left to prove. We first show that

$$b_i > \alpha_k, \text{ i.e., } \text{int } (\alpha_k \mathcal{P} + y_m) \cap \text{int } (\alpha_k \mathcal{P} + y_i) = \emptyset$$

Then one can repeat the same proof for  $b_{i+1} > \alpha_k$  by replacing  $R_{k_i}$  and  $\gamma_i$  by  $R_{k_{i+1}}$

and  $\gamma_{i+1}$ . So

$$b_{i+1} > \alpha_k, \text{ i.e., } \text{int}(\alpha_k \mathcal{P} + y_m) \cap \text{int}(\alpha_k \mathcal{P} + y_{i+1}) = \emptyset$$

Note that the  $\alpha_k \mathcal{P} + y_i$ 's are convex bodies with constant width  $\alpha_k$ ,  $R_{k_i}$  is the length of the vector  $\overrightarrow{Oy_i}$  and  $\beta_i$  is the angle between  $\overrightarrow{Oy_i}$  and  $\overrightarrow{Oy_{i+1}}$ . We have  $\beta_i \geq \frac{2\pi}{k}$  as explained earlier.

From the sine rule to the triangle  $Oy_i \triangle y_m$  on the figure 1.5.3, as  $\overrightarrow{OA}$  is chosen to be the angular bisector of  $\beta_i$ ,

$$\begin{aligned} \frac{R_{k_m} + \alpha_k(1 - R_{k_m}) - \epsilon_{k_m}}{\sin \gamma_i} &= \frac{R_{k_i} + \alpha_k(1 - R_{k_i}) - \epsilon_{k_i}}{\sin \left( \pi - \left( \frac{\beta_i}{2} + \gamma_i \right) \right)} \\ \Rightarrow \gamma_i &= \cot^{-1} \left[ \left( \frac{\alpha_k + R_{k_i} - \alpha_k R_{k_i} - \epsilon_{k_i}}{\alpha_k + R_{k_m} - \alpha_k R_{k_m} - \epsilon_{k_m}} - \cos \frac{\beta_i}{2} \right) \frac{1}{\sin \frac{\beta_i}{2}} \right]. \end{aligned} \quad (1.28)$$

For  $b_i$ , we have

$$\begin{aligned} \frac{b_i}{\sin \frac{\beta_i}{2}} &= \frac{R_{k_m} + \alpha_k(1 - R_{k_m}) - \epsilon_{k_m}}{\sin \gamma_i} \\ \Rightarrow b_i &= (R_{k_m} + \alpha_k - \alpha_k R_{k_m} - \epsilon_{k_m}) \frac{\sin \frac{\beta_i}{2}}{\sin \gamma_i}. \end{aligned}$$

In order to define for which  $k$   $b_i > \alpha_k$  holds, we first assume that

$$(R_{k_m} + \alpha_k - \alpha_k R_{k_m} - \epsilon_{k_m}) \frac{\sin \frac{\beta_i}{2}}{\sin \gamma_i} > \alpha_k. \quad (1.29)$$

Here if  $\frac{\sin \frac{\beta_i}{2}}{\sin \gamma_i} < 1$ , then

$$R_{k_m} + \alpha_k - \alpha_k R_{k_m} - \epsilon_{k_m} > (R_{k_m} + \alpha_k - \alpha_k R_{k_m} - \epsilon_{k_m}) \frac{\sin \frac{\beta_i}{2}}{\sin \gamma_i} > \alpha_k$$

$$\begin{aligned}
R_{k_m} + \alpha_k - \alpha_k R_{k_m} - \epsilon_{k_m} &> \alpha_k \\
R_{k_m} - \epsilon_{k_m} &> \alpha_k R_{k_m} \\
(1 - \alpha_k)R_{k_m} &> \epsilon_{k_m}.
\end{aligned} \tag{1.30}$$

This summarizes that if  $\epsilon_{k_m} < (1 - \alpha_k)R_{k_m}$ , (1.29) holds. The upper bound for  $\epsilon_{k_m}$  can be given as follows:

$$\epsilon_{k_m} < \alpha_k(1 - R_{k_m}).$$

If we supposed that  $\epsilon_{k_m}$  could be bigger than  $\alpha_k(1 - R_{k_m})$ , then it would mean that  $\mathcal{P} \cap \text{int}(\alpha_k \mathcal{P} + y_m) \neq \emptyset$  or/and  $\mathcal{P}$  is not convex since  $l_m$  is a tangent of  $\mathcal{P}$  and  $t_m$  is the touching point of  $\mathcal{P}$  and  $\alpha_k \mathcal{P} + y_m$ . (See figure 1.5.6).  $\mathcal{P} \cap \text{int}(\alpha_k \mathcal{P} + y_m) \neq \emptyset$  or

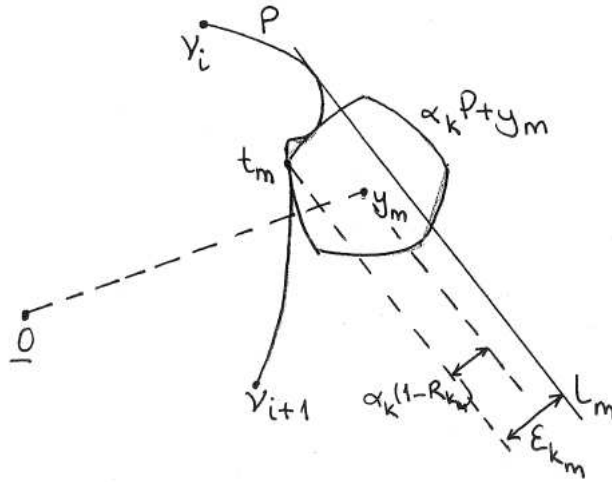

Figure 1.5.6

$\mathcal{P}$  being not convex give contradiction. So

$$0 < \epsilon_{k_m} < \alpha_k(1 - R_{k_m}).$$

We also know that  $\alpha_k < R_{k_m}$ ,

$$\Rightarrow \epsilon_{k_m} < \alpha_k - \alpha_k R_{k_m} < R_{k_m} - \alpha_k R_{k_m} = (1 - \alpha_k)R_{k_m}$$

as required in (1.30).

The proof of the following statement will finally complete the proof:

$$\frac{\sin \frac{\beta_i}{2}}{\sin \gamma_i} < 1.$$

Again, in order to define for which  $i = 1, \dots, k$ 's, the above statement holds, we assume that  $\sin \frac{\beta_i}{2} < \sin \gamma_i$ . Then

$$\frac{\beta_i}{2} < \gamma_i \quad \text{because} \quad \frac{\beta_i}{2} < \frac{\pi}{2} \quad \text{and} \quad \gamma_i > 0.$$

Assuming  $\frac{\beta_i}{2} < \gamma_i$  holds, we have  $\cot \frac{\beta_i}{2} < \cot \gamma_i$ . By considering 1.28,

$$\begin{aligned} \cot \frac{\beta_i}{2} < \cot \gamma_i &= \left( \frac{\alpha_k + R_{k_i} - \alpha_k R_{k_i} - \epsilon_{k_i}}{\alpha_k + R_{k_m} - \alpha_k R_{k_m} - \epsilon_{k_m}} - \cos \frac{\beta_i}{2} \right) \frac{1}{\sin \frac{\beta_i}{2}} \\ 2 \cos \frac{\beta_i}{2} &< \frac{\alpha_k + R_{k_i} - \alpha_k R_{k_i} - \epsilon_{k_i}}{\alpha_k + R_{k_m} - \alpha_k R_{k_m} - \epsilon_{k_m}} \\ \Rightarrow \alpha_k &< \frac{R_{k_i} - 2R_{k_m} \cos \frac{\beta_i}{2} + \left( 2 \cos \left( \frac{\beta_i}{2} \right) \epsilon_{k_m} - \epsilon_{k_i} \right)}{R_{k_i} - 2R_{k_m} \cos \frac{\beta_i}{2} + \left( 2 \cos \left( \frac{\beta_i}{2} \right) - 1 \right)}. \end{aligned} \quad (1.31)$$

If we define for which  $k$ 's

$$2 \cos \left( \frac{\beta_i}{2} \right) \epsilon_{k_m} - \epsilon_{k_i} < 2 \cos \left( \frac{\beta_i}{2} \right) - 1$$

holds, then

$$\alpha_k < \frac{R_{k_i} + 2R_{k_m} \cos \frac{\beta_i}{2} + \left(2 \cos \left(\frac{\beta_i}{2}\right) \epsilon_{k_m} - \epsilon_{k_i}\right)}{R_{k_i} + 2R_{k_m} \cos \frac{\beta_i}{2} + \left(2 \cos \left(\frac{\beta_i}{2}\right) - 1\right)} < \frac{R_{k_i} + 2R_{k_m} \cos \frac{\beta_i}{2}}{R_{k_i} + 2R_{k_m} \cos \frac{\beta_i}{2}} = 1.$$

First note that  $\epsilon_{k_m}$  is the difference between touching point  $t_m$  and the tangent of  $\mathcal{P}$ ,  $l_m$  with property  $l_m \perp \overrightarrow{Oy_m}$ . When the homothetic copy touches any vertex of  $\mathcal{P}$ , the difference  $\epsilon_{k_i}$  gets smaller.

Note that the arc  $\widehat{v_i v_{i+1}}$  curves around edges  $v_i$  and  $v_{i+1}$ , therefore; the tangent  $l_i$  almost meet the touching point  $t_i$  and in some cases it actually meets  $t_i$ . So  $\epsilon_{k_m} > \epsilon_{k_i}$ . (See Figure 1.5.7).

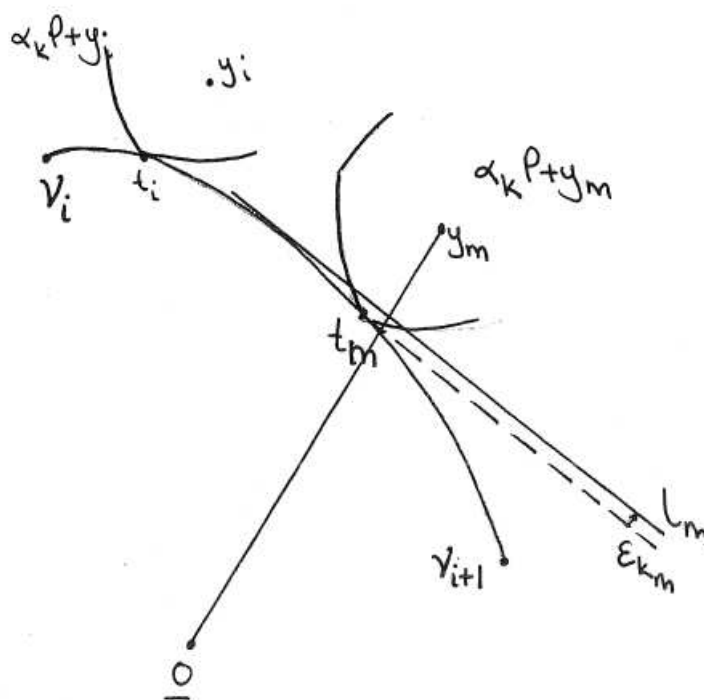

Figure 1.5.7

As mentioned above,

$$\begin{aligned} 2 \cos\left(\frac{\beta_i}{2}\right)\epsilon_{k_m} - \epsilon_{k_i} < 2 \cos\left(\frac{\beta_i}{2}\right) - 1 &\implies 2 \cos\frac{\beta_i}{2}(1 - \epsilon_{k_m}) + \epsilon_{k_i} > 1 \\ &\implies 2 \cos\frac{\beta_i}{2} > \frac{1 - \epsilon_{k_i}}{1 - \epsilon_{k_m}} \end{aligned}$$

$$\begin{aligned} \text{We know that } \beta_i \geq \frac{2\pi}{k} \text{ and } \epsilon_{k_m} > \epsilon_{k_i} &\implies \cos\frac{\pi}{k} \geq \cos\frac{\beta_i}{2} > \frac{1 - \epsilon_{k_i}}{2(1 - \epsilon_{k_m})} > \frac{1}{2} \\ &\implies \frac{\pi}{k} \leq \frac{\beta_i}{2} < \frac{\pi}{3} \\ &\implies k > 3. \end{aligned}$$

So if  $k > 3$ , then  $2 \cos\frac{\beta_i}{2}(1 - \epsilon_{k_m}) + \epsilon_{k_i} > 1$  holds. Briefly,  $\text{int}(\alpha_k\mathcal{P} + y_m) \cap \text{int}(\alpha_k\mathcal{P} + y_i) = \emptyset$  for  $k > 3$ . We have the following result:

There are at least  $k + 1$  copies to block  $\mathcal{P}$  while  $B_{\alpha_k}(D\mathcal{P}) = k$  when  $k = 5, 7, 9, \dots$  for the case 1 i.

We should emphasize that if the homothetic copies  $\{\alpha_k\mathcal{P} + y_i\}_{i=1}^k$  touch  $\partial\mathcal{P}$ , then the distance  $R_{k_i} + \alpha_k(1 - R_{k_i})$  is less than  $R'_{k_i} + \alpha_k(1 - R'_{k_i})$  where  $R'_{k_i}$  is the distance from  $\underline{Q}$  to the centre of  $\alpha_k\mathcal{P} + y_i$  when the homothetic copies do not touch  $\partial\mathcal{P}$ . So the proof given above still works for the homothetic copies which do not touch  $\partial\mathcal{P}$ . The assumption  $\mathcal{P} \cap (\alpha_k\mathcal{P} + y_i) \neq \emptyset$  for all  $i$  can be made.

**1 ii.** Now we will deal with the less likely case when the copies touch  $\mathcal{P}$  on the vertices  $v_i$  and  $v_{i+2}$  as indicated in the figure 1.5.8.

We shall prove that if  $\alpha_k\mathcal{P} + y_i$  and  $\alpha_k\mathcal{P} + y_{i+1}$  touch on  $v_i$  and  $v_{i+2}$ , then another copy of  $\alpha_k\mathcal{P}$ , disjoint from  $\alpha_k\mathcal{P} + y_1, \alpha_k\mathcal{P} + y_2, \dots, \alpha_k\mathcal{P} + y_k$  could be placed to touch



$\mathcal{P}$  at  $v_{i+1}$ .

Here we need to make sure that  $(\alpha_k \mathcal{P} + y_i) \cap (\alpha_k \mathcal{P} + y_{i+1}) = \emptyset$  so that  $\alpha_k \mathcal{P} + y_m$  can be placed between them.

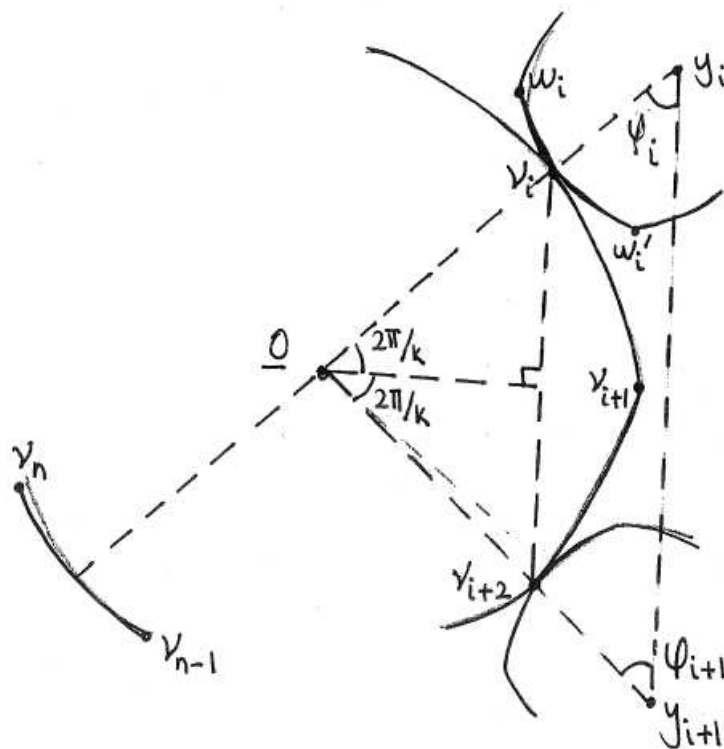

Figure 1.5.8

Let  $w_i$  and  $w'_i$  be two consecutive vertices of  $\alpha_k \mathcal{P} + y_i$  such that  $\alpha_k \mathcal{P} + y_i$  touches  $\mathcal{P}$  on the arc  $\widehat{w_i w'_i}$ . Namely, since  $\mathcal{P}$  is strictly convex, for each vertex,  $v_i$ , of  $\mathcal{P}$ , there exists an arc  $\widehat{w_i w'_i}$  of  $\alpha_k \mathcal{P} + y_i$  so that  $v_i$  touches arc  $\widehat{w_i w'_i}$ . Note that since  $k$  is an odd number, for each vertex,  $v_i$ , of  $\mathcal{P}$ , there is a corresponding arc opposite to this vertex. Similarly, when we place any homothetic copy on the boundary of  $\mathcal{P}$ , for each vertex,  $v_i$ , we have an arc of the homothetic copy. (See Figure 1.5.8). Here  $\alpha_k \mathcal{P} + y_m$

is defined to be a homothetic copy of  $\mathcal{P}$  so that it touches  $\mathcal{P}$  on the vertex  $v_{i+1}$ . (See Figure 1.5.9).

Here we will repeat the proof of the case 1 i. From the sine rule to the triangle  $\underline{O}y_i \triangle y_m$  on the figure 1.5.9, as  $\overline{OA}$  is chosen to be the angular bisector of  $\beta_i$ ,

$$\frac{R_{k_m} + \alpha_k(1 - R_{k_m}) - \epsilon_{k_m}}{\sin \gamma_i} = \frac{R_{k_i} + \alpha_k(1 - R_{k_i}) - \epsilon_{k_i}}{\sin \left( \pi - \left( \frac{\beta_i}{2} + \gamma_i \right) \right)}$$

$$\Rightarrow \gamma_i = \cot^{-1} \left[ \left( \frac{\alpha_k + R_{k_i} - \alpha_k R_{k_i} - \epsilon_{k_i}}{\alpha_k + R_{k_m} - \alpha_k R_{k_m} - \epsilon_{k_m}} - \cos \frac{\beta_i}{2} \right) \frac{1}{\sin \frac{\beta_i}{2}} \right]. \quad (1.32)$$

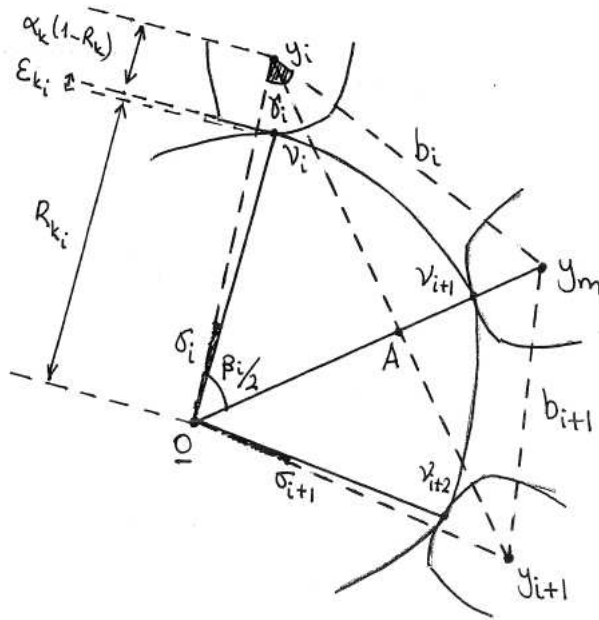

Figure 1.5.9

For  $b_i$ , we have

$$\begin{aligned} \frac{b_i}{\sin \frac{\beta_i}{2}} &= \frac{R_{k_m} + \alpha_k(1 - R_{k_m}) - \epsilon_{k_m}}{\sin \gamma_i} \\ \Rightarrow b_i &= (R_{k_m} + \alpha_k - \alpha_k R_{k_m} - \epsilon_{k_m}) \frac{\sin \frac{\beta_i}{2}}{\sin \gamma_i}. \end{aligned}$$

In order to define for which  $k$ 's  $b_i > \alpha_k$  holds, we first assume that

$$(R_{k_m} + \alpha_k - \alpha_k R_{k_m} - \epsilon_{k_m}) \frac{\sin \frac{\beta_i}{2}}{\sin \gamma_i} > \alpha_k. \quad (1.33)$$

Here if  $\frac{\sin \frac{\beta_i}{2}}{\sin \gamma_i} < 1$ , then

$$\begin{aligned} R_{k_m} + \alpha_k - \alpha_k R_{k_m} - \epsilon_{k_m} &> (R_{k_m} + \alpha_k - \alpha_k R_{k_m} - \epsilon_{k_m}) \frac{\sin \frac{\beta_i}{2}}{\sin \gamma_i} > \alpha_k \\ R_{k_m} + \alpha_k - \alpha_k R_{k_m} - \epsilon_{k_m} &> \alpha_k \\ R_{k_m} - \epsilon_{k_m} &> \alpha_k R_{k_m} \\ (1 - \alpha_k) R_{k_m} &> \epsilon_{k_m}. \end{aligned} \quad (1.34)$$

This summarizes that if  $\epsilon_{k_m} < (1 - \alpha_k) R_{k_m}$ , 1.33 holds. The upper bound for  $\epsilon_{k_m}$  can be given as follows:

$$\epsilon_{k_m} < \alpha_k(1 - R_{k_m}).$$

If we supposed that  $\epsilon_{k_m}$  could be bigger than  $\alpha_k(1 - R_{k_m})$ , then it would mean that  $\mathcal{P} \cap \text{int}(\alpha_k \mathcal{P} + y_m) \neq \emptyset$  or/and  $\mathcal{P}$  is not convex since  $l_m$  is a tangent of  $\mathcal{P}$  and  $t_m$  is the touching point of  $\mathcal{P}$  and  $\alpha_k \mathcal{P} + y_m$ . (See figure 1.5.9).

$\mathcal{P} \cap \text{int}(\alpha_k \mathcal{P} + y_m) \neq \emptyset$  or  $\mathcal{P}$  being not convex give contradiction. So

$$0 < \epsilon_{k_m} < \alpha_k(1 - R_{k_m}).$$

We also know that  $\alpha_k < R_{k_m}$ ,

$$\Rightarrow \epsilon_{k_m} < \alpha_k - \alpha_k R_{k_m} < R_{k_m} - \alpha_k R_{k_m} = (1 - \alpha_k) R_{k_m}$$

as required in (1.34).

The proof of  $\frac{\sin \frac{\beta_i}{2}}{\sin \gamma_i} < 1$  which was proved in the case 1 i completes the proof.

2. Now we will prove  $B_{\alpha_k}(\mathcal{P}) > k$ , when  $\alpha_k \mathcal{P} + y_i$  and  $\alpha_k \mathcal{P} + y_{i+1}$  touch  $\mathcal{P}$  on its arcs.

2 i. First we will consider while  $\alpha_k \mathcal{P} + y_i$  touches  $\mathcal{P}$  on arc  $\widehat{v_i v_{i+1}}$ ,  $\alpha_k \mathcal{P} + y_{i+1}$  touches  $\mathcal{P}$  on the consecutive arc  $\widehat{v_{i+1} v_{i+2}}$ . Here we choose  $\|v_i - t_i\| < \|v_{i+1} - t_{i+1}\|$  since  $\beta_i \geq \frac{2\pi}{k}$ . (See Figure 1.5.10).

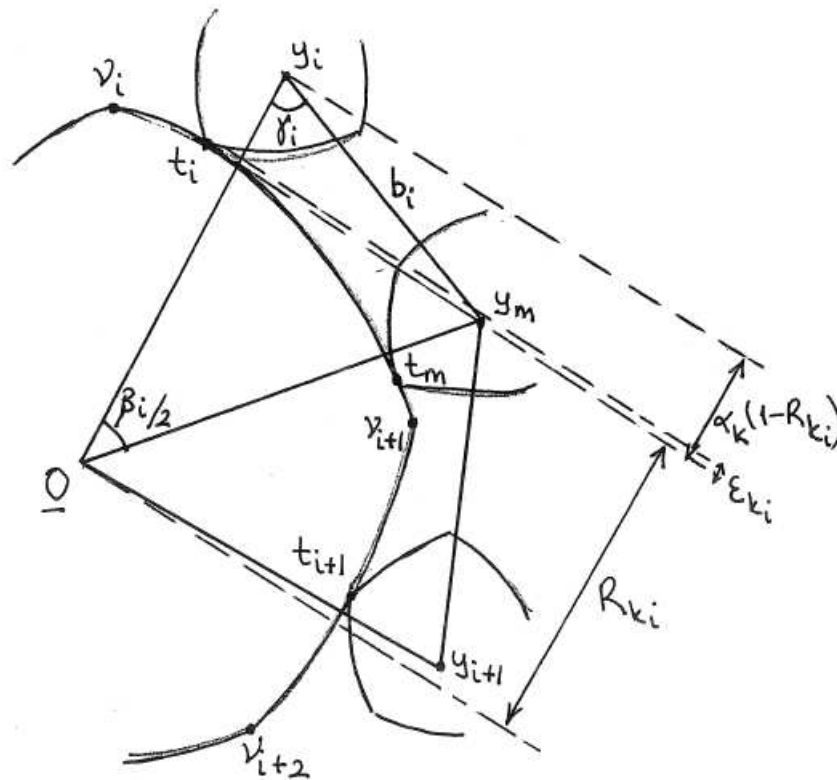

Figure 1.5.10

Similar to case 1 i, we only need to prove that  $b_i > \alpha_k$  and  $b_{i+1} > \alpha_k$ .

Now we prove that

$$b_i > \alpha_k, \text{ i.e., } \text{int}(\alpha_k \mathcal{P} + y_m) \cap \text{int}(\alpha_k \mathcal{P} + y_i) = \emptyset.$$

$b_{i+1} > \alpha_k$ , i.e.,  $\text{int}(\alpha_k \mathcal{P} + y_m) \cap \text{int}(\alpha_k \mathcal{P} + y_{i+1}) = \emptyset$  can be shown similarly by taking  $R_{k_{i+1}}(\gamma_{i+1})$  instead of  $R_{k_i}(\gamma_i)$  respectively since they both touch  $\mathcal{P}$  on the arcs, the calculation will be same.

Since  $\gamma_i$  is the angle between the vectors  $\overrightarrow{Oy_i}$  and  $\overrightarrow{y_i y_m}$ , from the sine rule in the figure 1.5.10,

$$\begin{aligned} \frac{R_{k_m} + \alpha_k(1 - R_{k_m}) - \epsilon_{k_m}}{\sin \gamma_i} &= \frac{R_{k_i} + \alpha_k(1 - R_{k_i}) - \epsilon_{k_i}}{\sin \left( \pi - \left( \frac{\beta_i}{2} + \gamma_i \right) \right)} \\ \Rightarrow \gamma_i &= \cot^{-1} \left[ \left( \frac{\alpha_k + R_{k_i} - \alpha_k R_{k_i} - \epsilon_{k_i}}{\alpha_k + R_{k_m} - \alpha_k R_{k_m} - \epsilon_{k_m}} - \cos \frac{\beta_i}{2} \right) \frac{1}{\sin \frac{\beta_i}{2}} \right]. \end{aligned} \quad (1.35)$$

As can be seen from Figure 1.5.10,

$$\begin{aligned} \frac{b_i}{\sin \frac{\beta_i}{2}} &= \frac{R_{k_m} + \alpha_k(1 - R_{k_m}) - \epsilon_{k_m}}{\sin \gamma_i} \\ \Rightarrow b_i &= (\alpha_k + R_{k_m} - \alpha_k R_{k_m} - \epsilon_{k_m}) \frac{\sin \frac{\beta_i}{2}}{\sin \gamma_i}. \end{aligned} \quad (1.36)$$

Like case 1 i, in order to define for which  $k$ 's,  $b_i > \alpha_k$  holds, we first assume that

$$(\alpha_k + R_{k_m} - \alpha_k R_{k_m} - \epsilon_{k_m}) \frac{\sin \frac{\beta_i}{2}}{\sin \gamma_i} > \alpha_k.$$

In fact, if  $\frac{\sin \frac{\beta_i}{2}}{\sin \gamma_i} < 1$ , then

$$\begin{aligned} \alpha_k < (\alpha_k + R_{k_m} - \alpha_k R_{k_m} - \epsilon_{k_m}) \frac{\sin \frac{\beta_i}{2}}{\sin \gamma_i} &< \alpha_k + R_{k_m} - \alpha_k R_{k_m} - \epsilon_{k_m} \\ \Rightarrow \alpha_k < \alpha_k + R_{k_m} - \alpha_k R_{k_m} - \epsilon_{k_m} \\ \Rightarrow \alpha_k R_{k_m} < R_{k_m} - \epsilon_{k_m} \\ \Rightarrow \epsilon_{k_m} < (1 - \alpha_k) R_{k_m} \end{aligned}$$

As explained in the case 1 i, if we take the upper bound for  $\epsilon_{k_m}$  such as  $\epsilon_{k_m} < (1 - R_{k_m})\alpha_k$ , then 1.36 holds. Since  $\alpha_k < R_{k_m}$ ,

$$\epsilon_{k_m} < \alpha_k - \alpha_k R_{k_m} < R_{k_m} - \alpha_k R_{k_m} = (1 - \alpha_k) R_{k_m} \text{ as required.}$$

The proof of  $\frac{\sin \frac{\beta_i}{2}}{\sin \gamma_i} < 1$  which was proved in the case 1 i completes the proof.

**2 ii.** Now we consider the case when  $\alpha_k \mathcal{P} + y_i$  touches  $\mathcal{P}$  on the arc  $\widehat{v_i v_{i+1}}$  and  $\alpha_k \mathcal{P} + y_{i+1}$  touches  $\mathcal{P}$  on the arc  $\widehat{v_{i+2} v_{i+3}}$ . (See the figure 1.5.11).

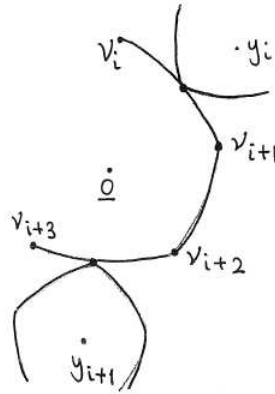

Figure 1.5.11

In the case 1 ii, we prove that when  $\alpha_k \mathcal{P} + y_i$  and  $\alpha_k \mathcal{P} + y_{i+1}$  touch  $\mathcal{P}$  on its vertices  $v_i$  and  $v_{i+2}$  respectively, we need a disjoint homothetic copy to block  $v_{i+1}$ . So each vertex must be blocked. Here we deduce the fact that there must be at least one disjoint homothetic copy which blocks  $v_{i+1}$  or  $v_{i+2}$  or even arc  $\widehat{v_{i+1}v_{i+2}}$ .

To be precise, if  $\alpha_k \mathcal{P} + y_i$  and  $\alpha_k \mathcal{P} + y_{i+1}$  are pushed the same distance towards  $v_i$  and  $v_{i+2}$  respectively, the same proof applies here as the case 1 ii.

There is another subcase that we consider: Both  $\alpha_k \mathcal{P} + y_i$  and  $\alpha_k \mathcal{P} + y_{i+1}$  touch  $\mathcal{P}$  on arc  $\widehat{v_i v_{i+1}}$ , then our assumption  $\beta_i \geq \frac{2\pi}{k}$  would not hold; so we ignore this subcase.

So there are at least  $k$  copies to block  $\mathcal{P}$  while  $B_{\alpha_k}(D\mathcal{P}) = k$  when  $k = 5, 7, 9, \dots$  for the case 2 ii.

**3.** One of the pair,  $\alpha_k \mathcal{P} + y_i$  touches  $\mathcal{P}$  on its vertex and the other pair,  $\alpha_k \mathcal{P} + y_{i+1}$  touches on its arc.

**3 i.** Now we will consider while  $\alpha_k \mathcal{P} + y_i$  touches  $\mathcal{P}$  on the vertex  $v_i$  and  $\alpha_k \mathcal{P} + y_{i+1}$  touches  $\mathcal{P}$  on the arc  $\widehat{v_i v_{i+1}}$ . Here  $\beta_i \geq \frac{2\pi}{k}$  as required, since  $\sigma_{i+1} \leq \sigma_i$  can be chosen where  $\sigma_i$  ( $\sigma_{i+1}$ ) is the angle between  $\overrightarrow{Ov_i}$  ( $\overrightarrow{Ov_{i+1}}$ ) and  $\overrightarrow{Oy_i}$  ( $\overrightarrow{Oy_{i+1}}$ ) respectively. (See Figure 1.5.12).

Similar to case 1 i, we only need to show  $b_i > \alpha_k$  and  $b_{i+1} > \alpha_k$ .

First we prove that

$$b_i > \alpha_k, \text{ i.e., } \text{int}(\alpha_k \mathcal{P} + y_m) \cap \text{int}(\alpha_k \mathcal{P} + y_i) = \emptyset.$$

Note that  $\alpha_k \mathcal{P} + y_i$  touches  $v_i$  and  $\alpha_k \mathcal{P} + y_m$  touches arc  $\widehat{v_i v_{i+1}}$  as in case 1 i. Hence  $\beta_i \geq \frac{2\pi}{k}$  and  $R_{k_i}, \epsilon_{k_i}, R_{k_m}, \epsilon_{k_m}$  are the same; so the angle  $\gamma_i$  is the same as well in the case 1 i and the calculation can be repeated.

We now show that

$$b_{i+1} > \alpha_k, \text{ i.e., } \text{int}(\alpha_k \mathcal{P} + y_m) \cap \text{int}(\alpha_k \mathcal{P} + y_{i+1}) = \emptyset.$$

$\alpha_k \mathcal{P} + y_{i+1}$  and  $\alpha_k \mathcal{P} + y_m$  both touch arc  $\widehat{v_i v_{i+1}}$  as in case 2 i; therefore the same proof applies here. There is another less likely case we should consider: If  $\alpha_k \mathcal{P} + y_i$  touches

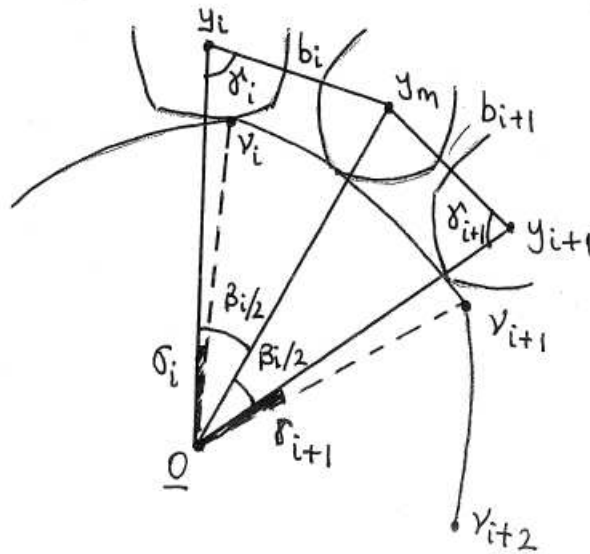

Figure 1.5.12

$\mathcal{P}$  on the vertex  $v_i$  and  $\alpha_k \mathcal{P} + y_{i+1}$  touches  $\mathcal{P}$  on the arc  $\widehat{v_{i+2} v_{i+3}}$ , then arc  $\widehat{v_{i+1} v_{i+2}}$  must be blocked as can be seen from the case case 2 i.

**3 ii.** Now we consider the case where  $\alpha_k \mathcal{P} + y_i$  touches  $\mathcal{P}$  on the arc  $\widehat{v_i v_{i+1}}$  and  $\alpha_k \mathcal{P} + y_{i+1}$  touches  $\mathcal{P}$  on the vertex  $v_{i+2}$ . Then  $\alpha_k \mathcal{P} + y_m$  touches  $\mathcal{P}$  on/or close to the vertex  $v_{i+1}$ . The calculation for this case follows the case 2 ii. Briefly,  $\alpha_k \mathcal{P} + y_{i+1}$  is pushed towards arc  $\widehat{v_{i+1} v_{i+2}}$ , the same proof can be repeated as in the case 2 ii.

We know that there are at least  $k + 1$  copies to block  $\mathcal{P}$  while  $B_{\alpha_k}(D\mathcal{P}) = k$  when  $k = 5, 7, 9, \dots$  for the case 3.



The above calculations of three cases show that  $k$  copies are not enough to block  $\mathcal{P}$ .

$$\implies B_{\alpha_k}(\mathcal{P}) > k = B_{\alpha_k}(D\mathcal{P})$$

$$\implies B_{\alpha_k}(\mathcal{P}) > B_{\alpha_k}(D\mathcal{P}) \text{ when } k = 5, 7, \dots \text{ as required.}$$

This completes the first part of the proof of Theorem 1.5.

We now prove Theorem 1.5(ii).

(ii) Let  $\mathcal{T}$  be the Reuleaux triangle with constant width 1 in  $\mathbb{R}^2$ . Let arc  $\widehat{AB}$ , arc  $\widehat{BC}$  and arc  $\widehat{CA}$  be the three circular arcs of  $\mathcal{T}$ . The positive number  $\alpha_l$  is the constant width of the homothetic copy  $\alpha_l\mathcal{T}$  of  $\mathcal{T}$ . Let  $\underline{O}$  be the centre of the circumscribed circle of  $\mathcal{T}$ .

We consider only

$$\alpha_l > \frac{\sin \frac{\pi}{l}}{2 \sin \frac{(l-1)\pi}{2l} - \sin \frac{\pi}{l}},$$

as calculated in the first part of the theorem 1.5. Now we will show how to choose  $l$  so that  $B_{\alpha_l}(\mathcal{T}) < B_{\alpha_l}(D\mathcal{T}) = l$  holds.

It follows immediately from the definitions that  $B_{\alpha_l}(\mathcal{T}) \leq B'_{\alpha_l}(\mathcal{T})$  where  $B'_{\alpha_l}(\mathcal{T})$  is the generalized blocking number and  $B_{\alpha_l}(\mathcal{T})$  is the unrestricted blocking number. We can see that  $B_{\alpha_l}(D\mathcal{T}) = B'_{\alpha_l}(D\mathcal{T})$ . So here we only need to show that

$$B'_{\alpha_l}(\mathcal{T}) < B'_{\alpha_l}(D\mathcal{T})$$

since  $B_{\alpha_l}(\mathcal{T}) \leq B'_{\alpha_l}(\mathcal{T})$ .

As explained in the first part, the sum of an arbitrary convex curve of constant width 1 with the same curve turned through  $180^\circ$  is a circle of radius 1. Hence  $D\mathcal{T}$  is the unit circle.

From the first part of the proof (i), we know that if  $B_{\alpha_l}(DT) = l = B'_{\alpha_l}(DT)$ , then

$$1 > \alpha_l > \frac{\sin \frac{\pi}{l}}{2 \sin \frac{(l-1)\pi}{2l} - \sin \frac{\pi}{l}}$$

with  $l > 3$ .

Now we calculate an  $l$  for which we have  $B'_{\alpha_l}(\mathcal{T}) < l$ . In order to do that, first we place  $l$  homothetic copies of  $\mathcal{T}$ ,  $\{\alpha_l \mathcal{T} + z_i\}_{i=1}^l$  around  $\partial \mathcal{T}$  in the way described as follows.

Let  $ABC$  be an equilateral triangle of side 1. We draw an arc of radius 1 inside the corresponding angle of each vertex of the triangle  $ABC$ . Then the end points of the resulting 3 arcs are joined by smaller arcs of radius  $\alpha_l = 1 - d(B, C)$  about the vertices of the triangle  $ABC$ . Given any two parallel supporting lines of the resulting curve, one is tangent to an arc of the larger circle and the other to an arc of the smaller circle, and both arcs have the same centre. Thus it is evident that  $\mathcal{T} - \alpha_l \mathcal{T}$  has constant width  $1 + \alpha_l$ .

We must place the centres of the translates,  $\alpha_l \mathcal{T} + z_i$ 's with  $i = 1, 2, \dots, l$  on the constant width body  $\mathcal{T} - \alpha_l \mathcal{T}$ . (See Figure 1.5.13). Note that the boundary of  $\mathcal{T} - \alpha_l \mathcal{T}$  consists of 3 circular arcs  $\sigma_i$  ( $i = 1, 2, 3$ ) with radius 1 and each with length  $\frac{\pi}{3}$ , and 3 circular arcs  $\tau_i$  ( $i = 1, 2, 3$ ) with radius  $\alpha_l$  near the vertices of  $\mathcal{T}$  which have length  $\frac{\pi}{3} \alpha_l$ . (See Figure 1.5.14). Here in order to distinguish between the length of an arc and the distance between two points, we denote the length of an arc with  $\|\cdot\|$  and the distance between points with  $d(\cdot, \cdot)$ .

Since there is a rotational symmetry in  $\mathcal{T} - \alpha_l \mathcal{T}$ , we take  $l = 3m$  and instead of considering  $l$  copies and proving that if they are enough to block  $\mathcal{T}$ , we take  $m$  copies of  $\alpha_l \mathcal{T}$  and place them on the arcs  $\tau_1$  and  $\sigma_1$  and see that whether these  $m$  copies block this part of  $\partial \mathcal{T}$ . Then the same proof will be repeated for the other parts of  $\partial \mathcal{T}$ .

Let  $z_1$  and  $p_1$  be the end-points of the small arc  $\tau_1$  of  $\partial(\mathcal{T} - \alpha_l \mathcal{T})$ . (See Figure 1.6.13). Then  $z_2$  ( $p_2$ ) is placed on  $\sigma_1$  so that the distances between  $p_1$  and  $z_2$ ;  $z_2$  and  $p_2$  are both  $\alpha_l$ . Similarly,  $z_i$  and  $p_i$  ( $i = 3, \dots, 3m$ ) are placed same way.

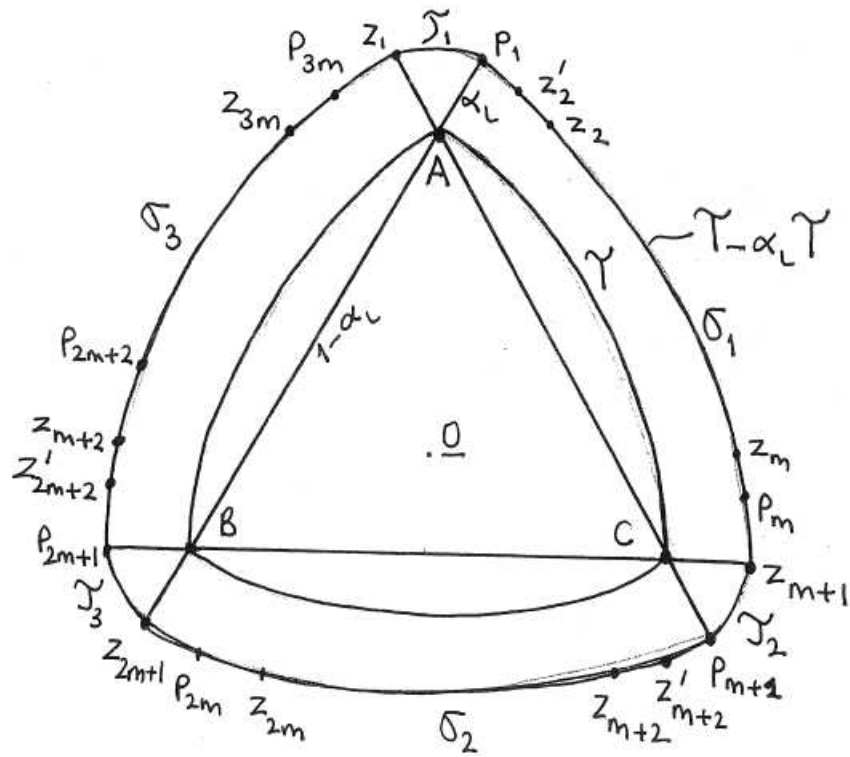

Figure 1.5.13

We denote the end-points of the other two small arcs  $\tau_2$  and  $\tau_3$  by  $z_{m+1}$ ,  $p_{m+1}$  and  $z_{2m+1}$ ,  $p_{2m+1}$  respectively. The points  $z_i$  and  $p_i$  ( $i = m + 2, \dots, 3m$ ) are placed in the same way on the arcs  $\sigma_2$  and  $\sigma_3$  respectively they were placed on the arc  $\sigma_1$  as described above.

Now we place the homothetic copies around  $\partial\mathcal{T}$  as follows: Firstly,  $\alpha_l \mathcal{T} + z_1$  is placed so that its centre of gravity  $z_1$ , is on the end point of arc  $\tau_1$  of  $\mathcal{T} - \alpha_l \mathcal{T}$  as can be seen

in Figure 1.5.13.

Then  $\alpha_l \mathcal{T} + z_2$  is placed so that its centre of gravity is on  $z_2$ . We know that the distance between  $z_1$  and  $p_1$  is  $\alpha_l$  as is the distance between  $p_1$  and  $z_2$ , i. e.,

$$d(z_1, p_1) = d(p_1, z_2) = \alpha_l.$$

Similarly, the next  $\alpha_l$  distance from  $z_2$  is defined by  $p_2$ , and so on. This procedure is repeated  $3m$  times. At the end of this procedure, we place  $\alpha_l \mathcal{T} + z_{3m}$  with the property  $d(p_{3m-1}, z_{3m}) = \alpha_l = d(z_{3m}, p_{3m})$ . Briefly, we have

$$d(z_i, p_i) = \alpha_l \quad \text{where } i = 1, \dots, 3m$$

and also

$$d(p_i, z_{i+1}) = \alpha_l \quad \text{where } i = 1, \dots, 3m - 1.$$

Furthermore; we have  $d(p_{3m}, z_1) = \alpha_l$ .

However; if we prove that the distance between  $p_m$  and  $z_{m+1}$  is less than  $\alpha_l$ ; i.e.  $d(p_m, z_{m+1}) < \alpha_l$ , then this will show that the homothetic copies,  $\alpha_l \mathcal{T} + z_i$ 's ( $i = 1, \dots, m$ ) might be pushed anticlockwise so that even if there were  $\alpha_l \mathcal{T} + p_i$ 's ( $i = 1, \dots, m$ ) which are placed on  $\partial(\mathcal{T} - \alpha_l \mathcal{T})$ , they would intersect with one of the copies of  $\alpha_l \mathcal{T} + z_i$  and  $\alpha_l \mathcal{T} + z_{i+1}$ . This statement will prove that

- i.** either  $\{\alpha_l \mathcal{T} + z_i\}_{i=2}^{m+1}$  is a blocking set for the arc  $\widehat{AC}$  of  $\partial \mathcal{T}$  so that  $m$  homothetic copies will be enough to block this part of  $\partial \mathcal{T}$  so

$$B_{\alpha_l}(\mathcal{T}) \leq 3m$$

- ii.** or since  $\text{int}(\alpha_l \mathcal{T} + p_m) \cap \text{int}(\alpha_l \mathcal{T} + z_{m+1}) \neq \emptyset$ ,  $\alpha_l \mathcal{T} + z_i$ 's ( $i = 1, \dots, m$ ) can be moved slightly so that  $m - 1$  homothetic copies will be enough to block this part of  $\partial \mathcal{T}$  and

$$B_{\alpha_l}(\mathcal{T}) \leq 3m - 1 < 3m.$$

Since  $p_i$ 's are equally distributed on the arcs  $\tau_1$  and  $\sigma_1$  with  $d(z_i, p_i) = \alpha_l$  where  $i = 1, \dots, m$ , and  $d(p_i, z_{i+1}) = \alpha_l$  where  $i = 1, \dots, m - 1$ , the angle  $\angle p_1 B p_m$  can be divided into  $2(m - 1)$  equal intervals. Let  $\phi_i$  be the angle between  $\overrightarrow{Bp_i}$  and  $\overrightarrow{Bz_{i+1}}$  ( $i = 1, \dots, m - 1$ ). Let  $\phi'_i := \phi_i$  be the angle between  $\overrightarrow{Bz_m}$  and  $\overrightarrow{Bp_m}$  ( $i = 1, \dots, m - 1$ ). Finally, let  $\phi_m$  be the angle between  $\overrightarrow{Bp_m}$  and  $\overrightarrow{Bz_{m+1}}$ . See Figure 1.5.14.

From the sine rule applied to the triangle  $z_{i+1} B \triangle p_i$  in Figure 1.5.14, as  $\underline{BD}$  is chosen to be the angular bisector of  $\phi_i$ ,

$$\frac{\frac{\alpha_l}{2}}{\sin \frac{\phi_i}{2}} = \frac{1}{\sin \frac{\pi}{2}}$$

$$\phi_i = 2 \arcsin \frac{\alpha_l}{2}.$$

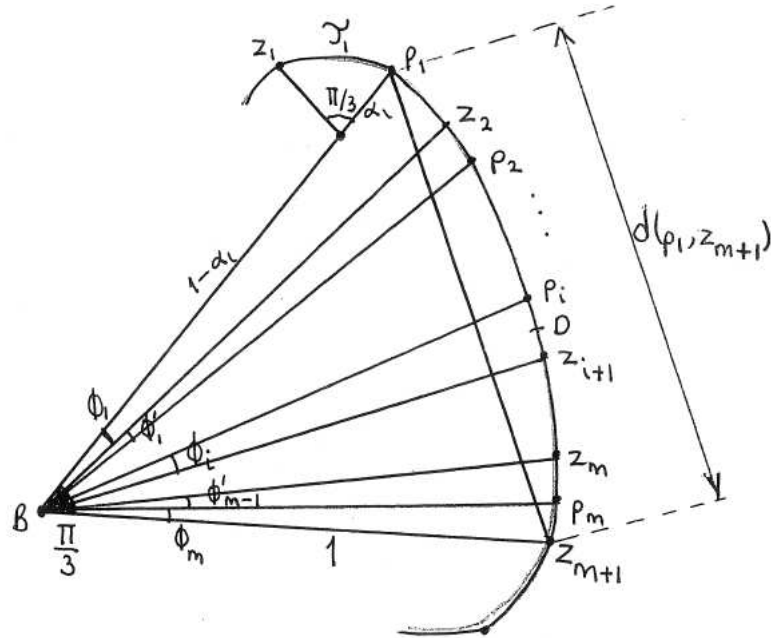

Figure 1.5.14

The length of the arc  $\widehat{p_1 z_{m+1}}$  is

$$\|\text{arc } \widehat{p_1 z_{m+1}}\| = \sum_{i=1}^{m-1} \|\text{arc } \widehat{p_i, z_{i+1}}\| + \sum_{i=1}^{m-1} \|\text{arc } \widehat{p_{i+1}, z_{i+1}}\| + \|\text{arc } \widehat{p_m, z_{m+1}}\|.$$

Similarly, the distance between  $p_1$  and  $z_{m+1}$  can be calculated as follows:

$$d(p_1, z_{m+1}) \leq \sum_{i=1}^{m-1} d(p_i, z_{i+1}) + \sum_{i=1}^{m-1} d(p_{i+1}, z_{i+1}) + d(p_m, z_{m+1}).$$

So the arc  $\widehat{p_1 z_{m+1}}$ , i.e.  $\sigma_1$ , has  $2(m-1) + 1$  intervals of which  $2(m-1)$  have equal length and the length of the other interval between  $\overrightarrow{Bp_m}$  and  $\overrightarrow{Bz_{m+1}}$ ,  $d(p_m, z_{m+1})$  which is less than  $\|\text{arc } \widehat{p_m z_{m+1}}\|$  will be calculated.

Here the corresponding angles of  $2(m-1)$  equal intervals and the corresponding angle of the interval between  $\overrightarrow{Bp_m}$  and  $\overrightarrow{Bz_{m+1}}$  add up to

$$\sum_{i=1}^{m-1} \phi_i + \sum_{i=1}^{m-1} \phi'_i + \phi_m = \frac{\pi}{3}.$$

Since for every  $i = 1, \dots, m-1$ ,  $\phi_i = \phi'_i$ , we have

$$\Rightarrow 2(m-1)\phi_i = \frac{\pi}{3} - \phi_m$$

$$\Rightarrow \phi_m = \frac{\pi}{3} - (2(m-1))\phi_i.$$

Now we have three possible ways to compare  $\phi_i$  and  $\phi_m$ . However, as will be proven, case 1 and case 2 give a contradiction for chosen  $\alpha_l$ , we deduce that case 1 and case 2 must be ignored.

1. If  $\phi_i = \phi_m$ , then  $d(p_m, z_{m+1}) = \alpha_l$ . So this means that  $2 \cdot (3m)$  homothetic copies  $\alpha_l \mathcal{T} + z_i$  and  $\alpha_l \mathcal{T} + p_i$ 's are placed around  $\partial \mathcal{T}$  and they fit perfectly, i.e., they touch  $\mathcal{T}$  without overlapping each other. We know that  $\phi_m = \frac{\pi}{3} - (2(m-1))\phi_i$ ,  $\phi_i = 2 \arcsin \frac{\alpha_l}{2}$  and  $\alpha_l > \frac{\sin \frac{\pi}{3m}}{2 \sin \frac{(3m-1)\pi}{6m} - \sin \frac{\pi}{3m}}$ , so

$$\phi_m = \frac{\pi}{3} - (2(m-1))\phi_i$$

$$\frac{\pi}{3} = (2m-1)\phi_i = 2(2m-1) \arcsin \frac{\alpha_l}{2}$$

$$\frac{\pi}{3(2m-1)} = \phi_i = 2 \arcsin \frac{\alpha_l}{2}$$

$$2 \sin \left( \frac{\pi}{6(2m-1)} \right) = \alpha_l > \frac{\sin \frac{\pi}{3m}}{2 \sin \frac{(3m-1)\pi}{6m} - \sin \frac{\pi}{3m}}. \quad (1.37)$$

However; (1.37) gives a contradiction since

$$y = \frac{\sin \frac{\pi}{3m}}{2 \sin \frac{(3m-1)\pi}{6m} - \sin \frac{\pi}{3m}} - 2 \sin \left( \frac{\pi}{6(2m-1)} \right) > 0 \quad (1.38)$$

as will be proven as follows. (Also see Figure 1.5.15).

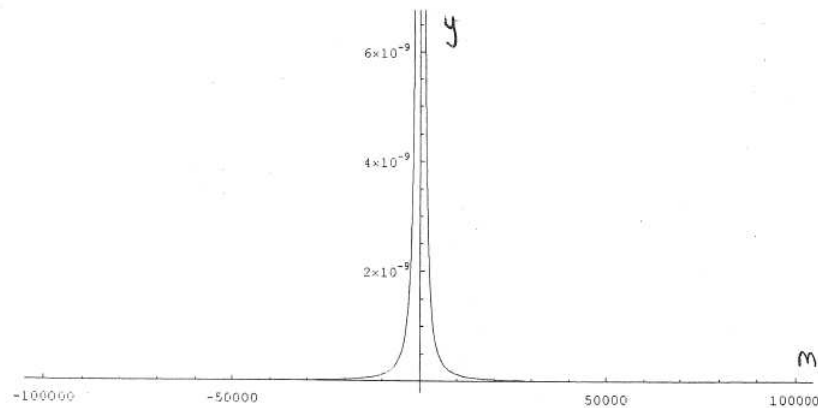

Figure 1.5.15

If (1.38) is simplified, then we have

$$y = \frac{\sin \frac{\pi}{6m}}{\left(\cos \frac{\pi}{12m} - \sin \frac{\pi}{12m}\right)^2} - 2 \sin \left(\frac{\pi}{12m-6}\right) > 0.$$

Now we define for which  $m$ 's, the above statement holds.

$$\frac{\sin \frac{\pi}{6m}}{\left(\cos \frac{\pi}{12m} - \sin \frac{\pi}{12m}\right)^2} > 2 \sin \left(\frac{\pi}{12m-6}\right)$$

i.e.,

$$\sin \frac{\pi}{6m} > 2 \sin \left(\frac{\pi}{12m-6}\right) \left(\cos \frac{\pi}{12m} - \sin \frac{\pi}{12m}\right)^2. \quad (1.39)$$

We know that

$$\sin \frac{\pi}{6m} = \sin 2 \frac{\pi}{12m} = 2 \sin \frac{\pi}{12m} \cdot \cos \frac{\pi}{12m}$$

and

$$\left(\cos \frac{\pi}{12m} - \sin \frac{\pi}{12m}\right)^2 = 1 - 2 \sin \frac{\pi}{12m} \cdot \cos \frac{\pi}{12m}.$$

From (1.39) and above statements,

$$\begin{aligned} \sin \frac{\pi}{6m} &> 2 \sin \left(\frac{\pi}{12m-6}\right) \left(\cos \frac{\pi}{12m} - \sin \frac{\pi}{12m}\right)^2 \\ 2 \sin \frac{\pi}{12m} \cdot \cos \frac{\pi}{12m} &> 2 \sin \left(\frac{\pi}{12m-6}\right) \left(1 - 2 \sin \frac{\pi}{12m} \cdot \cos \frac{\pi}{12m}\right) \\ 2 \sin \frac{\pi}{12m} \cdot \cos \frac{\pi}{12m} \left(1 + 2 \sin \left(\frac{\pi}{12m-6}\right)\right) &> 2 \sin \left(\frac{\pi}{12m-6}\right) \\ \sin \frac{\pi}{6m} &> \frac{2 \sin \left(\frac{\pi}{12m-6}\right)}{1 + 2 \sin \left(\frac{\pi}{12m-6}\right)} \end{aligned}$$

$$\frac{\sin \frac{\pi}{6m}}{1 - \sin \frac{\pi}{6m}} > 2 \sin \left(\frac{\pi}{12m-6}\right) \quad (1.40)$$



We know that

$$2 \sin \left( \frac{\pi}{12m-6} \right) > 2 \sin \left( \frac{\pi}{12m} \right)$$

since  $0 < \frac{\pi}{12m} < \frac{\pi}{12m-6} < \frac{\pi}{2}$ . If not  $\frac{\pi}{12m-6} > \frac{\pi}{2} \Rightarrow 2 > 12m-6 \Rightarrow \frac{2}{3} > m$  which gives a contradiction to  $3m = l \geq 3$ .

Again since

$$\sin \frac{\pi}{6m} = \sin 2 \frac{\pi}{12m} = 2 \sin \frac{\pi}{12m} \cdot \cos \frac{\pi}{12m},$$

from (1.40), we have

$$\begin{aligned} \frac{\sin \frac{\pi}{6m}}{1 - \sin \frac{\pi}{6m}} &> 2 \sin \left( \frac{\pi}{12m-6} \right) \\ \frac{2 \sin \frac{\pi}{12m} \cdot \cos \frac{\pi}{12m}}{1 - \sin \frac{\pi}{6m}} &> 2 \sin \left( \frac{\pi}{12m-6} \right) > 2 \sin \frac{\pi}{12m} \\ \frac{\cos \frac{\pi}{12m}}{1 - \sin \frac{\pi}{6m}} &> 1 \\ \cos \frac{\pi}{12m} &> 1 - \sin \frac{\pi}{6m}. \end{aligned} \tag{1.41}$$

We know that  $\cos \frac{\pi}{12m} > \sin \frac{\pi}{6m}$  since  $0 < \frac{\pi}{12m} < \frac{\pi}{6m} < \frac{\pi}{2}$ , i.e., when  $m$  gets bigger  $\cos \frac{\pi}{12m}$  gets bigger but  $\sin \frac{\pi}{6m}$  gets smaller. So

$$\begin{aligned} \cos \frac{\pi}{12m} &> \sin \frac{\pi}{6m} \\ \Rightarrow 1 - \cos \frac{\pi}{12m} &< 1 - \sin \frac{\pi}{6m}. \end{aligned}$$

Hence from 1.41, we have

$$\begin{aligned} \Rightarrow \cos \frac{\pi}{12m} &> 1 - \sin \frac{\pi}{6m} > 1 - \cos \frac{\pi}{12m} \\ \Rightarrow \cos \frac{\pi}{12m} &> 1 - \cos \frac{\pi}{12m} \end{aligned}$$

holds for any  $m \geq 2$  since  $\cos \frac{\pi}{12m} > \frac{1}{2}$  holds even for  $m > \frac{1}{4}$ . This concludes that (1.38) holds for  $m \geq 2$  as required.

So (1.37) gives a contradiction as

$$\frac{\sin \frac{\pi}{3m}}{2 \sin \frac{(3m-1)\pi}{6m} - \sin \frac{\pi}{3m}} > 2 \sin \left( \frac{\pi}{6(2m-1)} \right)$$

for  $m \geq 2$ . Namely, if  $\phi_i = \phi_m$ , i.e.,  $\alpha_l \mathcal{T} + z_i$ 's and  $\alpha_l \mathcal{T} + p_i$ 's fit perfectly around  $\partial \mathcal{T}$ , then we have the contradiction mentioned above. So this implies that for

$$\alpha_l > \frac{\sin \frac{\pi}{3m}}{2 \sin \frac{(3m-1)\pi}{6m} - \sin \frac{\pi}{3m}}, \quad \text{this case where } \phi_i = \phi_m \text{ must be ignored.}$$

2. If  $\phi_m > \phi_i$ , then  $d(p_m, z_{m+1}) > \alpha_l$ . This means that  $\alpha_l \mathcal{T} + z_{m+1}$  and  $\alpha_l \mathcal{T} + p_m$  do not even touch;

$$\partial(\alpha_l \mathcal{T} + z_{m+1}) \cap \partial(\alpha_l \mathcal{T} + p_m) = \emptyset.$$

So  $3m$  homothetic copies,  $\alpha_l \mathcal{T} + z_i$ 's are never enough to block  $\mathcal{T}$  since not only pairwise non-overlapping homothetic copies  $\alpha_l \mathcal{T} + z_i$ 's and  $\alpha_l \mathcal{T} + p_i$ 's touch  $\mathcal{T}$  but also there is even a gap between  $\alpha_l \mathcal{T} + z_{m+1}$  and  $\alpha_l \mathcal{T} + p_m$ .

$$\phi_m = \frac{\pi}{3} - (2(m-1))\phi_i > \phi_i$$

$$\frac{\pi}{3} > (2m-1)\phi_i$$

$$\frac{\pi}{3(2m-1)} > \phi_i = 2 \arcsin \frac{\alpha_l}{2}$$

$$2 \sin \left( \frac{\pi}{6(2m-1)} \right) > \alpha_{3m} > \frac{\sin \frac{\pi}{3m}}{2 \sin \frac{(3m-1)\pi}{6m} - \sin \frac{\pi}{3m}}. \quad (1.42)$$

Since in the case 1, it is proven that

$$\alpha_l > \frac{\sin \frac{\pi}{3m}}{2 \sin \frac{(3m-1)\pi}{6m} - \sin \frac{\pi}{3m}} > 2 \sin \left( \frac{\pi}{6(2m-1)} \right)$$

so that (1.42) gives a contradiction. We deduce that this case where  $\phi_m > \phi_i$  should not be considered for the chosen  $\alpha_l$ .

3. If  $\phi_m < \phi_i = \phi'_i$  for each  $i = 1, \dots, m-1$ , then  $d(p_m, z_{m+1}) < \alpha_l$ . So we will calculate an  $\alpha_l$  so that  $\phi_m < \phi_i$ , i.e.,  $d(p_m, z_{m+1}) < \alpha_l$  holds. We deduce that

$$\begin{aligned} \frac{\pi}{3} - (2(m-1))\phi_i &= \phi_m < \phi_i \\ \implies \frac{\pi}{3} &< \phi_i + 2(m-1)\phi_i = (2m-1)\phi_i \\ \implies \frac{\pi}{3} &< (2m-1)\phi_i. \end{aligned}$$

We also know that  $\phi_i = 2 \arcsin \frac{\alpha_l}{2}$ , so

$$\begin{aligned} \implies \frac{\pi}{3} &< (2m-1)\phi_i = 2(2m-1) \arcsin \frac{\alpha_l}{2} \\ \implies \frac{\pi}{6(2m-1)} &< \arcsin \frac{\alpha_l}{2} \\ \implies \sin \left( \frac{\pi}{6(2m-1)} \right) &< \frac{\alpha_l}{2} \\ \implies \alpha_l &> 2 \sin \left( \frac{\pi}{6(2m-1)} \right). \end{aligned} \tag{1.43}$$

Briefly,  $\phi_m < \phi_i$ , i.e.,  $d(p_m, z_{m+1}) < \alpha_l$  holds for  $\alpha_l > 2 \sin \left( \frac{\pi}{6(2m-1)} \right)$ . Note that if (1.43) holds, then  $B_{\alpha_l}(DT) \geq 3m$ . Namely, if  $\alpha_l > \frac{\sin \frac{\pi}{3m}}{2 \sin \frac{(3m-1)\pi}{6m} - \sin \frac{\pi}{3m}}$ , then  $B_{\alpha_l}(DT) = 3m$  is proven. From (1.38), we also know that

$$\alpha_l > \frac{\sin \frac{\pi}{3m}}{2 \sin \frac{(3m-1)\pi}{6m} - \sin \frac{\pi}{3m}} > 2 \sin \left( \frac{\pi}{6(2m-1)} \right).$$

From these statements, we have  $B_{\alpha_l}(DT) \geq 3m = l$  since the homothetic copies  $\alpha_l DT + x_i$ 's will be slightly smaller and  $3m$  copies might not be enough.

So  $B_{\alpha_l}(DT) \geq 3m = l$  for  $\alpha_l > 2 \sin\left(\frac{\pi}{6(2m-1)}\right)$  but we will show that  $B_{\alpha_l}(\mathcal{T}) \leq 3m - 1$  for the same  $\alpha_l$ .

Now we define the blocking configuration and show that  $3m - 1$  homothetic copies are enough to block  $\partial\mathcal{T}$ . Because  $d(p_m, z_{m+1}) < \alpha_l$  and  $d(z_m, p_m) = \alpha_l$ , we have

$$\begin{aligned} \text{int } (\alpha_l\mathcal{T} + p_m) \cap \text{int } (\alpha_l\mathcal{T} + z_{m+1}) &\neq \emptyset \\ \partial(\alpha_l\mathcal{T} + p_m) \cap \partial(\alpha_l\mathcal{T} + z_m) &\neq \emptyset. \end{aligned}$$

First we fix  $\alpha_l\mathcal{T} + z_{m+1}$  and  $\alpha_l\mathcal{T} + p_1$ . Here  $\alpha_l\mathcal{T} + z_m$  will be moved  $(\phi_i - \phi_m) - \epsilon_l$  anticlockwise. Note that the corresponding angle of overlapping area of  $\alpha_l\mathcal{T} + z_{m+1}$  and  $\alpha_l\mathcal{T} + p_m$  is  $\phi_i - \phi_m$ . See Figure 1.7.16. If  $\alpha_l\mathcal{T} + z_m$  and  $\alpha_l\mathcal{T} + p_m$  are moved anticlockwise that much,  $\partial(\alpha_l\mathcal{T} + z'_m) \cap \partial(\alpha_l\mathcal{T} + p'_m) \neq \emptyset$  and  $\partial(\alpha_l\mathcal{T} + p'_m) \cap \partial(\alpha_l\mathcal{T} + z_{m+1}) \neq \emptyset$ , i.e., they only touch each other.

Furthermore, let  $\epsilon_l$  be the angle so that if  $\alpha_l\mathcal{T} + z_m$  is moved  $\epsilon_l$  clockwise, then there is no other homothetic copy that might be put between  $\alpha_l\mathcal{T} + z'_m$  and  $\alpha_l\mathcal{T} + z_{m+1}$  without overlapping. That is the reason we choose  $(\phi_i - \phi_m) - \epsilon_l$ . Note that if the angle between  $\alpha_l\mathcal{T} + z_i$  and  $\alpha_l\mathcal{T} + z_{i+1}$  is  $2\phi_i + \epsilon_l$ , then another disjoint copy can not be inserted between these two copies since when copies  $\alpha_l\mathcal{T} + z_i$ ,  $\alpha_l\mathcal{T} + p_i$  and  $(\alpha_l\mathcal{T} + z_{i+1}, \alpha_l\mathcal{T} + p_i)$  touch each other, the corresponding angles are both  $\phi_i$  as defined.

Briefly, the transformation might be expressed as:

$$\begin{aligned} \alpha_l\mathcal{T} + z_m &\longmapsto \alpha_l\mathcal{T} + z'_m \\ \phi_i + \phi_m &\longmapsto 2\phi_i - \epsilon_l \end{aligned}$$

where  $\phi_i + \phi_m$  is the angle between  $\overrightarrow{Bz_m}$  and  $\overrightarrow{Bz_{m+1}}$  while  $2\phi_i - \epsilon_l$  will be the angle between  $\overrightarrow{Bz'_m}$  and  $\overrightarrow{Bz_{m+1}}$ .

Similarly,

$$\alpha_l \mathcal{T} + z_{m-1} \mapsto \alpha_l \mathcal{T} + z'_{m-1}$$

$$\phi_i + \phi_m + \epsilon_l \mapsto 2\phi_i - \epsilon_l$$

where  $\phi_i + \phi_m + \epsilon_l$  is the angle between  $\overrightarrow{Bz_{m-1}}$  and  $\overrightarrow{Bz'_m}$  while  $2\phi_i - \epsilon_l$  will be the angle between  $\overrightarrow{Bz'_{m-1}}$  and  $\overrightarrow{Bz'_m}$ . See Figure 1.5.16.

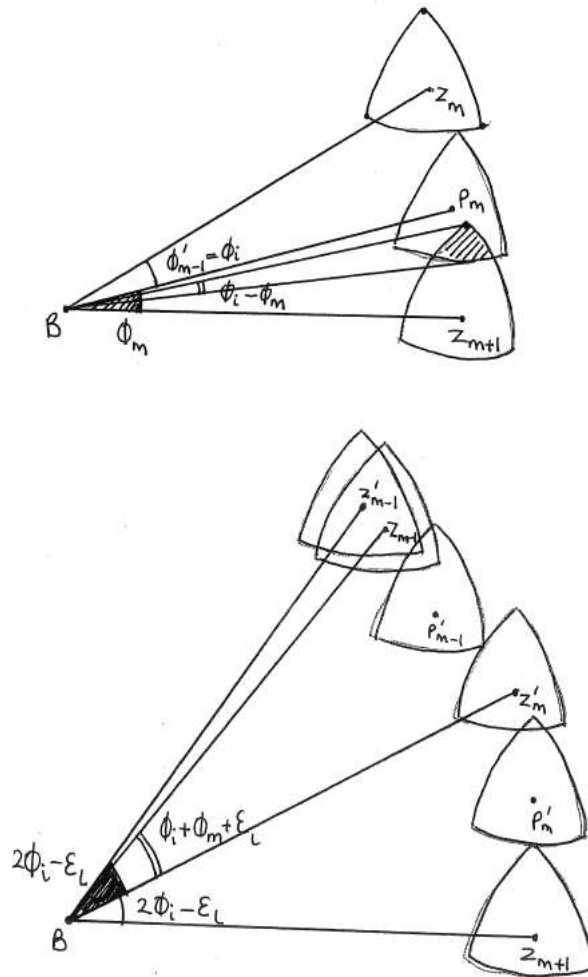

Figure 1.5.16

After this procedure is repeated  $m - 1$  times, the last copy moved is  $\alpha_l \mathcal{T} + z_2$ .

$$\alpha_l \mathcal{T} + z_2 \mapsto \alpha_l \mathcal{T} + z'_2.$$

Let  $\theta_1$  be the angle between  $\overrightarrow{Bp_1}$  and  $\overrightarrow{Bz'_2}$ ;

$$\theta_1 := \phi_m + (m - 1)\epsilon_l.$$

We repeat the same proof for the arc  $\widehat{BC}$ . This time, we fix  $\alpha_l \mathcal{T} + z_{2m+1}$  and  $\alpha_l \mathcal{T} + p_{m+1}$ . The transformation of  $\alpha_l \mathcal{T} + z_{2m}$  is as follows:

$$\begin{aligned} \alpha_l \mathcal{T} + z_{2m} &\mapsto \alpha_l \mathcal{T} + z'_{2m} \\ \phi_i + \phi_{2m} &\mapsto 2\phi_i - \epsilon_l \end{aligned}$$

where  $\phi_i + \phi_{2m}$  is the angle between  $\overrightarrow{Az_{2m}}$  and  $\overrightarrow{Az_{2m+1}}$  while  $2\phi_i - \epsilon_l$  will be the angle between  $\overrightarrow{Az'_{2m}}$  and  $\overrightarrow{Az_{2m+1}}$ . If this is repeated  $m - 1$  times we end up with

$$\alpha_l \mathcal{T} + z_{m+2} \mapsto \alpha_l \mathcal{T} + z'_{m+2}$$

Let  $\theta_2$  be the angle between  $\overrightarrow{Ap_{m+1}}$  and  $\overrightarrow{Az'_{m+2}}$ ;

$$\theta_2 := \phi_{2m} + (m - 1)\epsilon_l.$$

Again we repeat the same proof for the arc  $\widehat{AB}$ . We fix  $\alpha_l \mathcal{T} + z_1$  and  $\alpha_l \mathcal{T} + p_{2m+1}$ . The transformation of  $\alpha_l \mathcal{T} + z_{3m}$  is as follows:

$$\begin{aligned} \alpha_l \mathcal{T} + z_{3m} &\mapsto \alpha_l \mathcal{T} + z'_{3m} \\ \phi_i + \phi_{3m} &\mapsto 2\phi_i - \epsilon_l \end{aligned}$$

where  $\phi_i + \phi_{3m}$  is the angle between  $\overrightarrow{Cz_{3m}}$  and  $\overrightarrow{Cz_1}$  while  $2\phi_i - \epsilon_l$  will be the angle between  $\overrightarrow{Cz_1}$  and  $\overrightarrow{Cz'_{3m}}$ . If this is repeated  $m - 1$  times we end up with

$$\alpha_l \mathcal{T} + z_{2m+2} \mapsto \alpha_l \mathcal{T} + z'_{2m+2}.$$

Let  $\theta_3$  be the angle between  $\overrightarrow{Cp_{2m+1}}$  and  $\overrightarrow{Cz'_{2m+2}}$ :

$$\theta_3 := \phi_{3m} + (m - 1)\epsilon_l.$$

Since  $\phi_m = \phi_{2m} = \phi_{3m}$ , we have  $\theta_1 = \theta_2 = \theta_3 = \phi_m + (m - 1)\epsilon_l$ .

It is more likely that one of the pairs  $\alpha_l\mathcal{T} + z_1$  and  $\alpha_l\mathcal{T} + z'_2$  or  $\alpha_l\mathcal{T} + z_{m+1}$  and  $\alpha_l\mathcal{T} + z'_{m+2}$  or  $\alpha_l\mathcal{T} + z_{2m+1}$  and  $\alpha_l\mathcal{T} + z'_{2m+2}$  are to be close enough so that we might omit one of them and  $B_{\alpha_l}(\mathcal{T}) \leq 3m - 1$  since the angle  $\phi_m + (m - 1)\epsilon_l$ , between these pairs are smaller than all the other angles of the homothetic copies  $\alpha_l\mathcal{T} + z_i$ 's ( $i = 3, \dots, m, m + 3, \dots, 2m, 2m + 3, \dots, 3m$ ).

We take the copies  $\alpha_l\mathcal{T} + z_1$  and  $\alpha_l\mathcal{T} + z'_2$ . In order to show that  $B_{\alpha_l}(\mathcal{T}) \leq 3m - 1$ ,  $\text{int}(\alpha_l\mathcal{T} + z_1) \cap \text{int}(\alpha_l\mathcal{T} + z'_2) \neq \emptyset$  must hold.

If  $\theta_1 = 0$ , then  $\partial(\alpha_l\mathcal{T} + z_1) \cap \partial(\alpha_l\mathcal{T} + z'_2) \neq \emptyset$ , i.e., they only touch. See Figure 1.5.17.

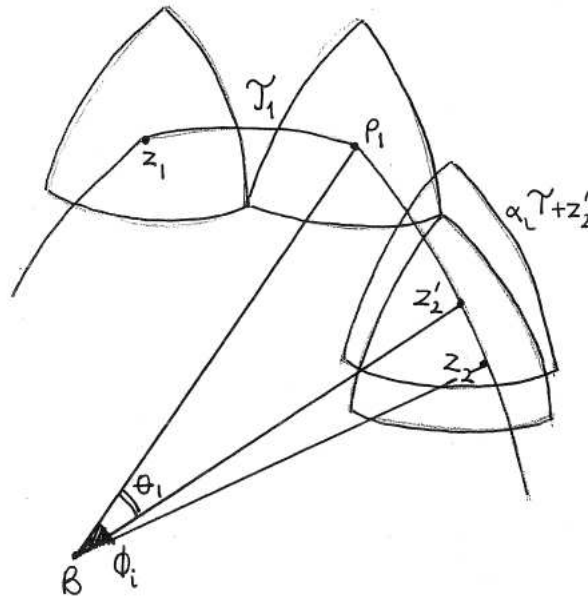

Figure 1.5.17

If  $\alpha_l \mathcal{T} + z'_2$  is moved  $\epsilon_l$  more further clockwise, so that it is on the arc  $\tau_1$ , then this shows that  $\alpha_l \mathcal{T} + z_1$  and  $\alpha_l \mathcal{T} + z'_2$  overlap each other.

So to show  $\text{int}(\alpha_l \mathcal{T} + z_1) \cap \text{int}(\alpha_l \mathcal{T} + z'_2) \neq \emptyset$ ,  $\alpha_l \mathcal{T} + z'_2$  must be moved  $\theta_1 - \epsilon_l = \left(\phi_m + (m-1)\epsilon_l\right) - \epsilon_l$  anticlockwise. Note that for each  $i = 3, \dots, m, m+3, \dots, 2m, 2m+3, \dots, 3m$ , the angle between  $\alpha_l \mathcal{T} + z_i$  and  $\alpha_l \mathcal{T} + z_{i+1}$  is  $2\phi_i + \epsilon_l$ . If each homothetic copies are moved  $\left(\phi_m + (m-1)\epsilon_l\right) - \epsilon_l$  further anticlockwise, then the angles will stay the same for these copies.

We know that if the angle between copies is  $2\phi_i + \epsilon_l$ , then this means that another copy can not be inserted between these copies. So the angle between  $\alpha_l \mathcal{T} + z'_{m+2}$  and  $\alpha_l \mathcal{T} + p_{m+1}$  must be  $\phi_i$  so that the angle between  $\alpha_l \mathcal{T} + z'_{m+2}$  and  $\alpha_l \mathcal{T} + z_{m+1}$  will be  $2\phi_i - \epsilon_l$  and we can not place another disjoint copy without overlapping.

We move  $\alpha_l \mathcal{T} + p_{m+1}, \alpha_l \mathcal{T} + z_{m+1}$  and  $\alpha_l \mathcal{T} + z'_i$  ( $i = m, \dots, 2$ ) and  $\alpha_l \mathcal{T} + p'_i$  ( $i = m, \dots, 2$ ). So each copies are moved  $\phi_i - \left(\phi_m + (m-1)\epsilon_l\right)$  anticlockwise as explained above. Similarly, we also move  $\alpha_l \mathcal{T} + p_{2m+1}, \alpha_l \mathcal{T} + z_{2m+1}$  and  $\alpha_l \mathcal{T} + z'_i$  ( $i = 2m, \dots, m+2$ ) and  $\alpha_l \mathcal{T} + p'_i$  ( $i = 2m, \dots, m+2$ ) same amount,  $\phi_i - \left(\phi_m + (m-1)\epsilon_l\right)$  anticlockwise.

After this transformation, we will have

$$\text{int}(\alpha_l \mathcal{T} + z''_2) \cap \text{int}(\alpha_l \mathcal{T} + z_1) \neq \emptyset$$

where  $z''_2$  is the twice transformed copy of  $z_2$ . Hence; the angle between these two homothetic copies is  $\phi_m + (m-1)\epsilon_l + 2\left(\phi_i - \left(\phi_m + (m-1)\epsilon_l\right)\right)$ . Note that

$$\phi_m + (m-1)\epsilon_l + 2\left(\phi_i - \left(\phi_m + (m-1)\epsilon_l\right)\right) > \phi_i$$

must hold, since if there is equality here, this means  $\alpha_l \mathcal{T} + z''_2$  and  $\alpha_l \mathcal{T} + z_1$  only touch each other since  $\alpha_l \mathcal{T} + z''_2$  replaces  $\alpha_l \mathcal{T} + p_1$ . However; if the inequality holds, we will have overlapping for  $\alpha_l \mathcal{T} + z_1$  and  $\alpha_l \mathcal{T} + z''_2$ .



So the calculation follows:

$$\phi_m + (m-1)\epsilon_l + 2\left(\phi_i - (\phi_m + (m-1)\epsilon_l)\right) > \phi_i$$

$$\phi_m + 2\phi_i - 2\phi_m - (m-1)\epsilon_l > \phi_i$$

$$\frac{\phi_i - \phi_m}{m-1} > \epsilon_l$$

We also know that  $\phi_m = \frac{\pi}{3} - (2m-2)\phi_i$ ; so

$$\implies \frac{\phi_i - \left(\frac{\pi}{3} - (2m-2)\phi_i\right)}{m-1} > \epsilon_l$$

$$\implies \frac{(2m-1)\phi_i - \frac{\pi}{3}}{m-1} > \epsilon_l > 0 \quad (1.44)$$

Here  $(2m-1)\phi_i - \frac{\pi}{3} > 0$ , i.e.,

$$\phi_i > \frac{\pi}{3(2m-1)}.$$

Briefly, we have

$$\text{int}(\alpha_l \mathcal{T} + z_1) \cap \text{int}(\alpha_l \mathcal{T} + z_2'') \neq \emptyset$$

holds with the property  $\frac{\phi_i - \phi_m}{m-1} > \epsilon_l > 0$ . If so,  $\alpha_l \mathcal{T} + z_2''$  can be omitted.

If  $m = 1$ , then (1.44) gives a contradiction and (1.43) means  $\alpha_l > 1$  which is also a contradiction. If  $m = 2$ , then  $\alpha_l > 0.347$  and  $\phi_i > \frac{\pi}{9}$ . When  $m$  gets bigger, the lower bound in (1.43) for  $\alpha_l$  gets smaller. So (1.43) holds for  $m \geq 2$  since  $\alpha_l < 1$  as required.

As a result, the blocking set will be  $\{\alpha_k \mathcal{T} + z_1\} \cup \{\alpha_k \mathcal{T} + z_i\}_{i=2}^{3m}$  with properties:

$$\text{int} \mathcal{T} \cap \text{int}(\alpha_l \mathcal{T} + z_i) = \emptyset \quad \text{must hold for all } i,$$

$$\mathcal{T} \cap (\alpha_l \mathcal{T} + z_i) \neq \emptyset \quad \text{holds for all } i,$$

and if there is an additional copy of  $\alpha_l \mathcal{T}$ ,  $\alpha_l \mathcal{T} + z_{3m+1}$  so that

$$\partial \mathcal{T} \cap \partial(\alpha_l \mathcal{T} + z_{3m+1}) \neq \emptyset$$

then

$$\text{int}(\alpha_l \mathcal{T} + z_{3m+1}) \cap \text{int}(\alpha_l \mathcal{T} + z_i) \neq \emptyset \text{ holds for all } i=1, 3, \dots, 3m.$$

So the total number of homothetic copies which are required to block  $\partial \mathcal{T}$  is  $3m - 1 = l - 1$  since considering arcs  $\tau_1$  and  $\sigma_1$ , we have  $\{\alpha_l \mathcal{T} + z_1\}$  and  $\{\alpha_l \mathcal{T} + z_i\}_{i=3}^{m+1}$ , for arcs  $\tau_2$  and  $\sigma_2$ , we have  $\{\alpha_l \mathcal{T} + z_i\}_{i=m+1}^{2m+1}$ , for arcs  $\tau_3$  and  $\sigma_3$ , we have  $\{\alpha_l \mathcal{T} + z_i\}_{i=2m+1}^{3m}$ .

We know that  $B'_{\alpha_l}(DT) = B_{\alpha_l}(DT) = l$  where  $l > 3$ . Hence we get the following result:

$$\begin{aligned} B_{\alpha_l}(\mathcal{T}) &\leq B'_{\alpha_l}(\mathcal{T}) \leq 3m - 1 < 3m \leq B_{\alpha_l}(DT) \\ B_{\alpha_l}(\mathcal{T}) &< B_{\alpha_l}(DT) \end{aligned}$$

where  $l = 6, 9, \dots, 3m, \dots$

This concludes the proof.  $\square$

We quote the following conjecture also given in the paper of K. Böröczky Jr., D. G. Larman, S. Sezgin and C. M. Zong [2],

**Conjecture 1.5.1** *For  $n \geq 3$  there exist convex bodies  $\mathcal{K}$  in  $\mathbb{R}^n$  such that  $B_\alpha(\mathcal{K}) \neq B_\alpha(D\mathcal{K})$  holds for some  $\alpha$ .*

It is worth mentioning that the same property mentioned in the Theorem 1.6 also does not hold for the generalized Newton number as it is the counterpart of the generalized blocking number.

In the next theorem, we will consider the generalized Newton number which was first investigated by L. Fejes Tóth in 1970 [7] for small  $\alpha > 1$ . Let  $\mathcal{K}$  be an  $n$ -dimensional convex body. Let a positive number  $\alpha$  be the width of the homothetic copy  $\alpha\mathcal{K}$ , of  $\mathcal{K}$ . We define *the Generalized Newton Number* to be the maximal number of non-overlapping translates of  $\alpha\mathcal{K}$  which can touch  $\mathcal{K}$  at its boundary. We denote this number by  $N_\alpha(\mathcal{K})$ .

**Theorem 1.6** *Let  $\mathcal{P}$  be any Reuleaux Polygon in  $\mathbb{R}^2$ . Then*

$$(i) \quad N_{\alpha_k}(\mathcal{P}) > N_{\alpha_k}(D\mathcal{P}) = k \quad \text{where} \quad \alpha_k = \frac{\sin \frac{\pi}{k}}{1 - \sin \frac{\pi}{k}} + \epsilon_k$$

$$(k \geq 7 \text{ is an odd number and } \epsilon_k > 0)$$

$$(ii) \quad N_{\alpha_l}(\mathcal{P}) < N_{\alpha_l}(D\mathcal{P}) = l \quad \text{where} \quad \alpha_l = \frac{\sin \frac{\pi}{l}}{1 - \sin \frac{\pi}{l}}$$

$$(l \geq 7 \text{ is an odd number}).$$

Here  $N_{\alpha_k}(\mathcal{P})$  ( $N_{\alpha_l}(\mathcal{P})$ ) is the generalized Newton number with smaller copies  $\alpha_k\mathcal{P}$  ( $\alpha_l\mathcal{P}$ ) of  $\mathcal{P}$  respectively.

### Proof of 1.6

(i) Let  $\mathcal{P}$  be a Reuleaux polygon with odd number,  $k$ , of vertices and with constant width 1.

The key steps in this proof are as follows:

- Firstly, we calculate the values of  $\alpha_k$  for  $N_{\alpha_k}(D\mathcal{P}) = k$  so that  $N_{\alpha_k}(\mathcal{P})$  will be calculated for the same  $\alpha_k$ .
- Secondly, we construct the covering set with  $k$  homothetic copies of  $\mathcal{P}$ ,  $\alpha_k\mathcal{P} + y_i$  around  $\partial\mathcal{P}$  and show that these  $k$  homothetic copies do not overlap each other.

- Finally, we enlarge each homothetic copies of  $\mathcal{P}$ ,  $\alpha_k \mathcal{P} + y_i$  to  $\alpha'_k \mathcal{P} + y'_i$ , and show that these new copies do not overlap each other so that  $N_{\alpha'_k}(\mathcal{P}) \geq k$  will hold. However; since  $\alpha'_k > \alpha_k$ ,  $N_{\alpha'_k}(D\mathcal{P}) \leq k - 1$ . Briefly, when we make the copies slightly bigger,  $N_{\alpha_k}(\mathcal{P})$  remains the same while  $N_{\alpha_k}(D\mathcal{P})$  decreases by at least one, i.e., this will prove that

$$N_{\alpha'_k}(\mathcal{P}) \geq k > k - 1 \geq N_{\alpha'_k}(D\mathcal{P})$$

$$\Rightarrow N_{\alpha_k}(\mathcal{P}) > N_{\alpha_k}(D\mathcal{P}) \text{ if } \alpha_k = \frac{\sin \frac{\pi}{k}}{1 - \sin \frac{\pi}{k}} + \varepsilon_k \quad (k = 7, 9, \dots)$$

As in Theorem 1.5,  $D\mathcal{P}$  is the unit circle. Let  $x_i$  be the centre of the homothetic copies of  $D\mathcal{P}$ . We choose  $\alpha_k > 0$  so that  $k$  non-overlapping circles of radius  $\alpha_k$ ,  $\alpha_k D\mathcal{P} + x_i$  ( $i = 1, \dots, k$ ), can be placed around the unit circle  $D\mathcal{P}$ , in a way that each touches the unit circle and its two neighbours.

Let  $Q$  be the centre of  $D\mathcal{P}$ . From the sine rule applied to the triangle in Figure 1.6.1., as  $\underline{QA}$  is chosen to be the angular bisector of  $\angle x_i Q x_{i+1} = 2\frac{\pi}{k}$ ,

$$\frac{1 + \alpha_k}{\sin \frac{\pi}{2}} = \frac{\alpha_k}{\sin \frac{\pi}{k}}$$

$$\alpha_k = \frac{\sin \frac{\pi}{k}}{1 - \sin \frac{\pi}{k}}.$$

So if  $N_{\alpha_k}(D\mathcal{P}) = k$ , then we must choose

$$\alpha_k = \frac{\sin \frac{\pi}{k}}{1 - \sin \frac{\pi}{k}}$$

where  $k = 7, 9, 11, \dots$  and then  $\alpha_k < 1$ .

Now we will prove that

$$N_{\alpha_k}(\mathcal{P}) \geq k \text{ for } \alpha_k = \frac{\sin \frac{\pi}{k}}{1 - \sin \frac{\pi}{k}}, \quad k = 7, 9, 11, \dots$$

as calculated above.

Let  $Q'$  be the centre of circumscribed circle of  $\mathcal{P}$ . Let  $v_1, \dots, v_k$  be the vertices of  $\mathcal{P}$ . Note that the Reuleaux polygon,  $\mathcal{P}$ , is constructed by arcs,  $\widehat{arc v_i v_{i+1}}$  of radius 1 which we call the edges of the polygon. Let  $y_i$  ( $i = 1, \dots, k$ ) be the centres of homothetic copies,  $\alpha_k \mathcal{P} + y_i$ 's with radius  $\alpha_k$ . They can be expressed as

$$y_i = \left( \frac{R_k + \alpha_k(1 - R_k)}{R_k} \right) v_i.$$

The copies are to be placed around the edges of  $\mathcal{P}$  such that each  $\alpha_k \mathcal{P} + y_i$  touches  $\mathcal{P}$  at the vertex of  $\mathcal{P}$ ,  $v_i$

$$v_i := \partial(\alpha_k \mathcal{P} + y_i) \cap \partial \mathcal{P}$$

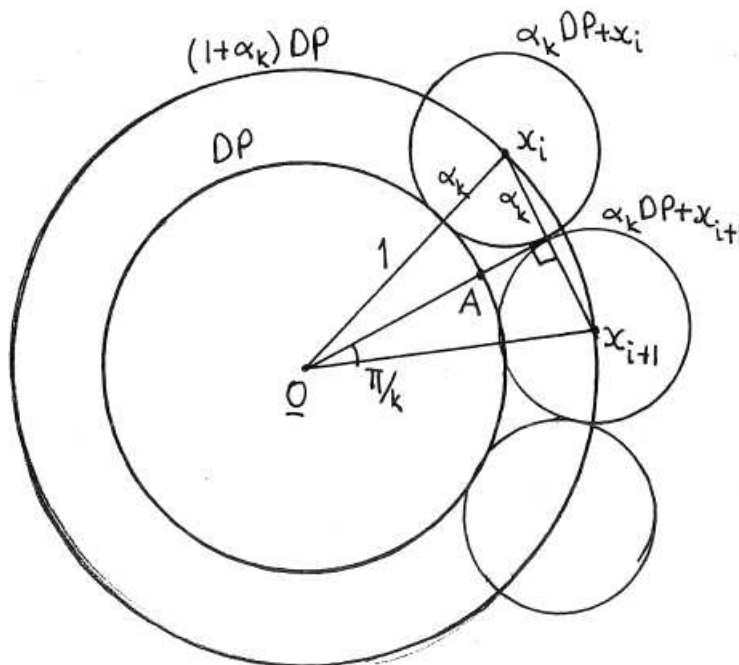

Figure 1.6.1

and  $\underline{O}$ ,  $v_i$  and  $y_i$  are collinear. Here  $\underline{O}'B$  is chosen to be the angular bisector of  $\angle y_i \underline{O}' y_{i+1} = \frac{2\pi}{k}$ .

Now we prove that  $\{\alpha_k \mathcal{P} + y_1, \dots, \alpha_k \mathcal{P} + y_k\}$  are pairwise disjoint homothetic copies of  $\mathcal{P}$ . From the Figure 1.6.2,

$$\frac{\frac{\|y_i - y_{i+1}\|}{2}}{\sin \frac{\pi}{k}} = \frac{R_k + \alpha_k(1 - R_k)}{\sin \frac{\pi}{2}}$$

$$\|y_i - y_{i+1}\| = 2 \left( R_k + \alpha_k(1 - R_k) \right) \sin \frac{\pi}{k}.$$

Furthermore as can be seen in Figure 1.6.3,

$$\cos \frac{\pi}{2k} = \frac{1/2}{R_k},$$

$$\Rightarrow R_k = \frac{1}{2 \cos \frac{\pi}{2k}}.$$

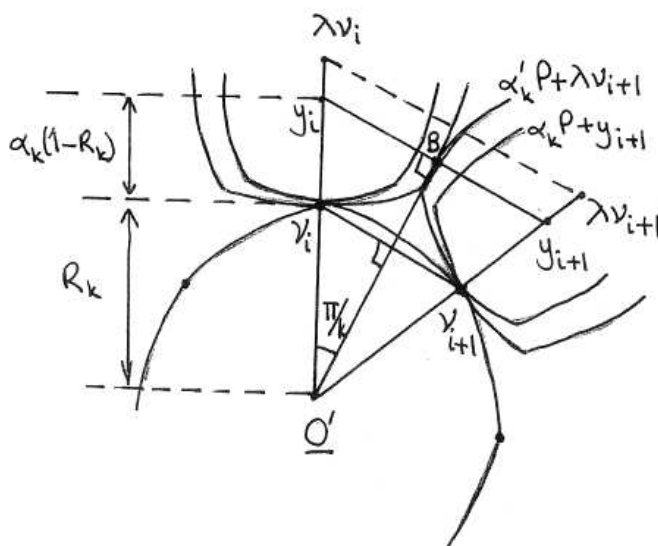

Figure 1.6.2

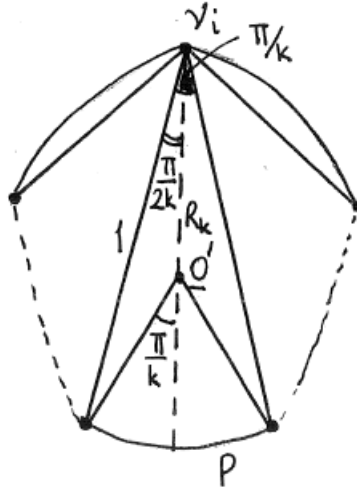

Figure 1.6.3

If  $\|y_i - y_{i+1}\| > \alpha_k$ , then the homothetic copies are non-overlapping whilst if  $\|y_i - y_{i+1}\| = \alpha_k$ , then the homothetic copies only touch each other. So we suppose that

$$\|y_i - y_{i+1}\| < \alpha_k$$

and we get a contradiction. Hence we have  $\|y_i - y_{i+1}\| \geq \alpha_k$ , i.e., the homothetic copies are non-overlapping. We know that  $\|y_i - y_{i+1}\| = 2 \left( R_k + \alpha_k(1 - R_k) \right) \sin \frac{\pi}{k}$  and  $R_k = \frac{1}{2 \cos \frac{\pi}{2k}}$ . The calculation is as follows:

$$\|y_i - y_{i+1}\| = 2 \left[ \frac{1}{2 \cos \frac{\pi}{2k}} + \left( 1 - \frac{1}{2 \cos \frac{\pi}{2k}} \right) \frac{\sin \frac{\pi}{k}}{1 - \sin \frac{\pi}{k}} \right] \sin \frac{\pi}{k} < \alpha_k = \frac{\sin \frac{\pi}{k}}{1 - \sin \frac{\pi}{k}}$$

$$\Leftrightarrow \frac{1}{\cos \frac{\pi}{2k}} + \frac{2 \sin \frac{\pi}{k}}{1 - \sin \frac{\pi}{k}} - \frac{\sin \frac{\pi}{k}}{\left( 1 - \sin \frac{\pi}{k} \right) \cos \frac{\pi}{2k}} - \frac{1}{1 - \sin \frac{\pi}{k}} < 0$$

$$\Leftrightarrow \frac{1 - \sin \frac{\pi}{k} + 2 \sin \frac{\pi}{k} \cos \frac{\pi}{2k} - \sin \frac{\pi}{k} - \cos \frac{\pi}{2k}}{\cos \frac{\pi}{2k} (1 - \sin \frac{\pi}{k})} < 0$$

$$\begin{aligned} \Leftrightarrow 1 - 2 \sin \frac{\pi}{k} + 2 \cos \frac{\pi}{2k} \sin \frac{\pi}{k} - \cos \frac{\pi}{k} &< 0 \\ \Leftrightarrow \left(1 - \cos \frac{\pi}{2k}\right) \left(1 - 2 \sin \frac{\pi}{k}\right) &< 0. \end{aligned} \quad (1.45)$$

Since  $1 > \cos \frac{\pi}{2k}$  and  $\frac{1}{2} > \sin \frac{\pi}{k}$  for  $k = 7, 9, \dots$ , the inequality (1.45) gives a contradiction. Hence the homothetic copies,  $\alpha_k \mathcal{P} + y_i$ 's are pairwise non-overlapping.

In order to show that  $k$  homothetic copies are not enough to cover  $\partial \mathcal{P}$ , i.e.,  $N_{\alpha'_k}(\mathcal{P}) \geq k$ , we slightly enlarge the translates of  $\alpha_k \mathcal{P} + y_i$  ( $i = 1, \dots, k$ ) so that they touch  $\mathcal{P}$  and each other consecutively but they do not overlap each other. Then we prove that the number of these enlarged translates gives the maximal number of non-overlapping translates of  $\alpha_k \mathcal{P} + y_i$ . So let the vector  $y'_i$  be the centres of enlarged copies, where  $i = 1, \dots, k$ . They have the form:

$$y'_i = \left( \frac{R_k + \alpha'_k(1 - R_k)}{R_k} \right) v_i,$$

where  $\alpha'_k > \alpha_k$ . The enlarged copies,  $\alpha'_k \mathcal{P} + y'_i$ 's have the following properties

$$\alpha_k \rightarrow \alpha'_k = \frac{\sin \frac{\pi}{k}}{1 - \sin \frac{\pi}{k}} + \varepsilon_k \quad \text{and} \quad y_i \rightarrow y'_i = \lambda v_i$$

where  $\lambda := \frac{R_k + \alpha_k(1 - R_k)}{R_k} > 1$  and  $\varepsilon_k > 0$ . Briefly, the enlarged copies will be  $\alpha'_k \mathcal{P} + \lambda v_i$  where  $i = 1, \dots, k$ . Here  $\lambda = \frac{R_k + \alpha_k(1 - R_k)}{R_k} > 1$  is chosen to make sure that  $\alpha'_k \mathcal{P} + \lambda v_i$  touches  $\mathcal{P}$  at  $v_i$ .

If we prove that

$$\|y'_i - y'_{i+1}\| = \|\lambda v_i - \lambda v_{i+1}\| = \lambda \|v_i - v_{i+1}\| \geq \alpha'_k,$$

then this will show that  $\text{int}(\alpha'_k \mathcal{P} + \lambda v_i) \cap \text{int}(\alpha'_k \mathcal{P} + \lambda v_{i+1}) = \emptyset$ , i.e., either they only touch or they are non-overlapping translates of  $\alpha'_k \mathcal{P}$ . Since Newton number is the



maximal number of homothetic copies, so it is expected that

$$\partial(\alpha'_k \mathcal{P} + \lambda v_i) \cap \partial(\alpha'_k \mathcal{P} + \lambda v_{i+1}) \neq \emptyset$$

must hold or they must be as close as touching; so  $\epsilon_k$  will be very small.

As can be seen in the figure 1.6.2,

$$\frac{R_k}{\sin \frac{\pi}{2}} = \frac{\|v_i - v_{i+1}\|}{2 \sin \frac{\pi}{k}}$$

$$\implies \|v_i - v_{i+1}\| = 2 R_k \sin \frac{\pi}{k}$$

$$\implies \lambda \|v_i - v_{i+1}\| = 2 \lambda R_k \sin \frac{\pi}{k}.$$

Now we calculate a  $k$  for which we have  $\lambda \|v_i - v_{i+1}\| \geq \alpha'_k$  as required. So we suppose that this statement holds and calculate the specific  $k$ 's. We know that  $R_k = \frac{1}{2 \cos \frac{\pi}{2k}}$ ,  $\alpha_k = \frac{\sin \frac{\pi}{k}}{1 - \sin \frac{\pi}{k}}$ ,  $\lambda := \frac{R_k + \alpha'_k(1 - R_k)}{R_k}$  and  $\lambda \|v_i - v_j\| = 2 \lambda R_k \sin \frac{\pi}{k}$ .

$$\text{So } \lambda \|v_i - v_{i+1}\| > \alpha_k$$

$$\Leftrightarrow \frac{R_k + \alpha_k(1 - R_k)}{R_k} \cdot 2 R_k \sin \frac{\pi}{k} > \alpha_k$$

$$\Leftrightarrow 2 \sin \frac{\pi}{k} \left( R_k + \alpha_k(1 - R_k) \right) > \alpha_k$$

$$\Leftrightarrow 2 R_k \sin \frac{\pi}{k} \geq \alpha_k \left( 1 - 2 \sin \frac{\pi}{k} + 2 R_k \sin \frac{\pi}{k} \right)$$

$$\Leftrightarrow \frac{2 R_k \sin \frac{\pi}{k}}{1 - 2 \sin \frac{\pi}{k} + 2 R_k \sin \frac{\pi}{k}} > \alpha_k$$

$$\Leftrightarrow \frac{\frac{2}{2 \cos \frac{\pi}{2k}} \cdot \sin \frac{\pi}{k}}{1 - 2 \sin \frac{\pi}{k} + 2 \frac{1}{2 \cos \frac{\pi}{2k}} \sin \frac{\pi}{k}} > \alpha_k$$

$$\Leftrightarrow \frac{\sin \frac{\pi}{k}}{\cos \frac{\pi}{2k} - 2 \sin \frac{\pi}{k} \cos \frac{\pi}{2k} + \sin \frac{\pi}{k}} > \alpha_k = \frac{\sin \frac{\pi}{k}}{1 - \sin \frac{\pi}{k}}.$$

By showing

$$\frac{\sin \frac{\pi}{k}}{\cos \frac{\pi}{2k} - 2 \sin \frac{\pi}{k} \cos \frac{\pi}{2k} + \sin \frac{\pi}{k}} > \frac{\sin \frac{\pi}{k}}{1 - \sin \frac{\pi}{k}}, \quad (1.46)$$

we shall define  $\epsilon_k > 0$  as follows:

$$\frac{\sin \frac{\pi}{k}}{\cos \frac{\pi}{2k} - 2 \sin \frac{\pi}{k} \cos \frac{\pi}{2k} + \sin \frac{\pi}{k}} - \frac{\sin \frac{\pi}{k}}{1 - \sin \frac{\pi}{k}} \geq \epsilon_k. \quad (1.47)$$

In order to prove (1.46), it is sufficient to show that

$$\cos \frac{\pi}{2k} - 2 \sin \frac{\pi}{k} \cos \frac{\pi}{2k} + \sin \frac{\pi}{k} < 1 - \sin \frac{\pi}{k}$$

$$\Leftrightarrow \cos \frac{\pi}{2k} \left( 1 - 2 \sin \frac{\pi}{k} \right) < 1 - 2 \sin \frac{\pi}{k}$$

$$\Leftrightarrow \cos \frac{\pi}{2k} < 1 \text{ which holds for every } k.$$

Then  $\lambda \|v_i - v_{i+1}\| \geq \alpha_k + \epsilon_k = \alpha'_k$  for  $\epsilon_k > 0$  given by 1.47.

So the assumption  $\lambda \|v_i - v_{i+1}\| \geq \alpha'_k$  is proved for  $k = 7, 9, \dots$ . Therefore for every  $k$  there exists some  $\epsilon_k > 0$  with the property

$$\frac{\sin \frac{\pi}{k}}{\cos \frac{\pi}{2k} - 2 \sin \frac{\pi}{k} \cos \frac{\pi}{2k} + \sin \frac{\pi}{k}} - \frac{\sin \frac{\pi}{k}}{1 - \sin \frac{\pi}{k}} \geq \epsilon_k$$

such that  $N_{\alpha'_k}(\mathcal{P}) \geq k$  holds for

$$\alpha'_k = \frac{\sin \frac{\pi}{k}}{1 - \sin \frac{\pi}{k}} + \varepsilon_k.$$

Note that if the equality in (1.47) holds then  $N_{\alpha'_k}(\mathcal{P}) = k$  holds.

On the other hand, we prove that for this specific  $\alpha'_k$ ,  $N_{\alpha'_k}(D\mathcal{P}) \leq k - 1$ . Let  $x'_i$  be the centre of the enlarged homothetic copies of  $D\mathcal{P}$ ,  $\alpha'_k D\mathcal{P} + x'_i$ . Let  $\psi$  be the angle between  $\vec{O}x'_i$  and  $\vec{O}x'_{i+1}$ . We know that  $\|x_i - x_{i+1}\| = \alpha_k$ . If  $\|x'_i - x'_{i+1}\| < \alpha'_k$ , then  $\text{int}(\alpha_k D\mathcal{P} + x'_i) \cap \text{int}(\alpha_k D\mathcal{P} + x'_{i+1}) \neq \emptyset$  for all  $i$ . This yields  $N_{\alpha'_k}(D\mathcal{P}) \leq k - 1$ , since at least one of the homothetic copies can be omitted.

We suppose that  $\|x'_i - x'_{i+1}\| \geq \alpha'_k$  holds. From Figure 1.6.4,

$$\begin{aligned} \frac{\alpha'_k}{\sin \frac{\psi}{2}} &\leq \frac{1 + \alpha'_k}{\sin \frac{\pi}{2}} \\ \psi &\geq 2 \arcsin \frac{\alpha'_k}{1 + \alpha'_k}. \end{aligned}$$

Since  $\alpha'_k > \alpha_k$ ,  $\frac{\alpha'_k}{1 + \alpha'_k} > \frac{\alpha_k}{1 + \alpha_k}$ ; so

$$\psi \geq 2 \arcsin \frac{\alpha'_k}{1 + \alpha'_k} > 2 \arcsin \frac{\alpha_k}{1 + \alpha_k}.$$

We know that  $k$  homothetic copies are placed around  $\partial\mathcal{P}$ , hence  $k\psi = 2\pi$ .

$$\begin{aligned} \psi = \frac{2\pi}{k} &\geq 2 \arcsin \frac{\alpha_k}{1 + \alpha_k} \\ \Leftrightarrow \frac{\pi}{k} &\geq \arcsin \frac{\alpha_k}{1 + \alpha_k} \end{aligned}$$

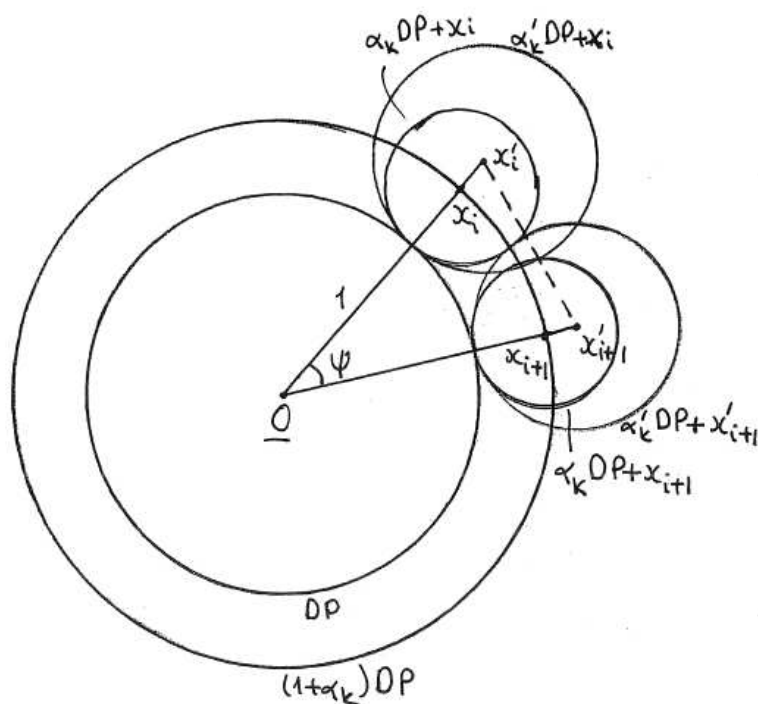

Figure 1.6.4

$$\Leftrightarrow \sin \frac{\pi}{k} > \frac{\alpha_k}{1 + \alpha_k} = \frac{\frac{\sin \frac{\pi}{k}}{1 - \sin \frac{\pi}{k}}}{1 + \frac{\sin \frac{\pi}{k}}{1 - \sin \frac{\pi}{k}}}$$

$$\Leftrightarrow \sin \frac{\pi}{k} > \sin \frac{\pi}{k}.$$

This gives a contradiction. So,  $\|x'_i - x'_{i+1}\| < \alpha'_k$ ,

$$\text{int}(\alpha'_k DP + x'_i) \cap \text{int}(\alpha'_k DP + x'_{i+1}) \neq \emptyset \text{ for all } i.$$

This implies that

$$N_{\alpha'_k}(\mathcal{P}) \geq k \text{ and } N_{\alpha'_k}(DP) \leq k - 1.$$

Hence  $N_{\alpha'_k}(\mathcal{P}) \geq k > k - 1 \geq N_{\alpha'_k}(D\mathcal{P})$ .

So we obtain the following result:

$$N_{\alpha_k}(\mathcal{P}) > N_{\alpha_k}(D\mathcal{P}) \quad \text{if} \quad \alpha_k = \frac{\sin \frac{\pi}{k}}{1 - \sin \frac{\pi}{k}} + \varepsilon_k, \quad k = 7, 9, \dots$$

(ii) Let  $\mathcal{P}$  be the Reulaux  $l$ -gon with constant width 1 in  $\mathbb{R}^2$ . The positive number  $\alpha_l$  is the constant width of the homothetic copy  $\alpha_l\mathcal{P}$  of  $\mathcal{P}$ . Let  $\underline{O}$  be the centre of the circumscribed circle of  $\mathcal{P}$ .

From the first part of the proof, we know that  $D\mathcal{P}$  is the unit circle and if  $N_{\alpha_l}(D\mathcal{P}) = l$  then we must choose  $\alpha_l = \frac{\sin \frac{\pi}{l}}{1 - \sin \frac{\pi}{l}}$  where  $l = 7, 9, \dots$

We claim that if  $l$  is large enough then

$$N_{\alpha_l}(\mathcal{P}) < N_{\alpha_l}(D\mathcal{P}) \quad \text{where} \quad \alpha_l = \frac{\sin \frac{\pi}{l}}{1 - \sin \frac{\pi}{l}}. \quad (1.48)$$

Let  $v_1, \dots, v_m$  be the vertices of  $\mathcal{P}$ . The Reuleaux polygon  $\mathcal{P}$  is constructed by arcs, arc  $\widehat{v_i v_{i+1}}$  of radius 1. Let  $z_i$  ( $i = 1, \dots, l$ ) be the centres of homothetic copies,  $\alpha_l\mathcal{P} + z_i$ 's with radius  $\alpha_l$ . Note that unlike the first part of the proof (i), the number of vertices of  $\mathcal{P}$  is  $m$  while the number of homothetic copies which will be placed around  $\mathcal{P}$  is  $l$ .

Now we calculate an  $l$  for which we have  $N_{\alpha_l}(\mathcal{P}) < l$ . In order to do this, we place  $l$  homothetic copies of  $\mathcal{P}$ ,  $\{\alpha_l\mathcal{P} + z_i\}_{i=1}^l$  around  $\partial\mathcal{P}$  in the way described below.

Let  $\mathcal{K}$  be a regular  $l$ -gon. We draw an arc of radius 1 inside the corresponding angle of each vertex of  $\mathcal{K}$ . Then the end points of the resulting  $l$  arcs are joined by smaller

arcs of radius  $\alpha_l$  about the vertices of  $\mathcal{K}$ . Given any two parallel supporting lines of the resulting curve, one is tangent to an arc of the larger circle and the other is tangent to an arc of the smaller circle, and both arcs have the same centre. Hence it is evident that  $\mathcal{P} - \alpha_l \mathcal{P}$  has constant width  $1 + \alpha_l$ . (See Figure 1.6.5).

We must place the centres of the translates,  $\alpha_l \mathcal{P} + z_i$ 's with  $i = 1, \dots, l$  on the constant width body  $\mathcal{P} - \alpha_l \mathcal{P}$ . Note that the boundary of  $\mathcal{P} - \alpha_l \mathcal{P}$  consists of  $m$  circular arcs  $\sigma_i$  ( $i = 1, \dots, m$ ) with radius 1 and each with length  $\frac{\pi}{m}$  and  $m$  circular arcs  $\tau_i$  ( $i = 1, \dots, m$ ) with radius  $\alpha_l$  near the vertices of  $\mathcal{P}$ , which have length  $\frac{\pi}{m} \cdot \alpha_l$ . (See Figure 1.6.5). Here in order to distinguish between the length of an arc and the distance between two points, we denote the length of an arc by  $\|\cdot\|$  and the distance between

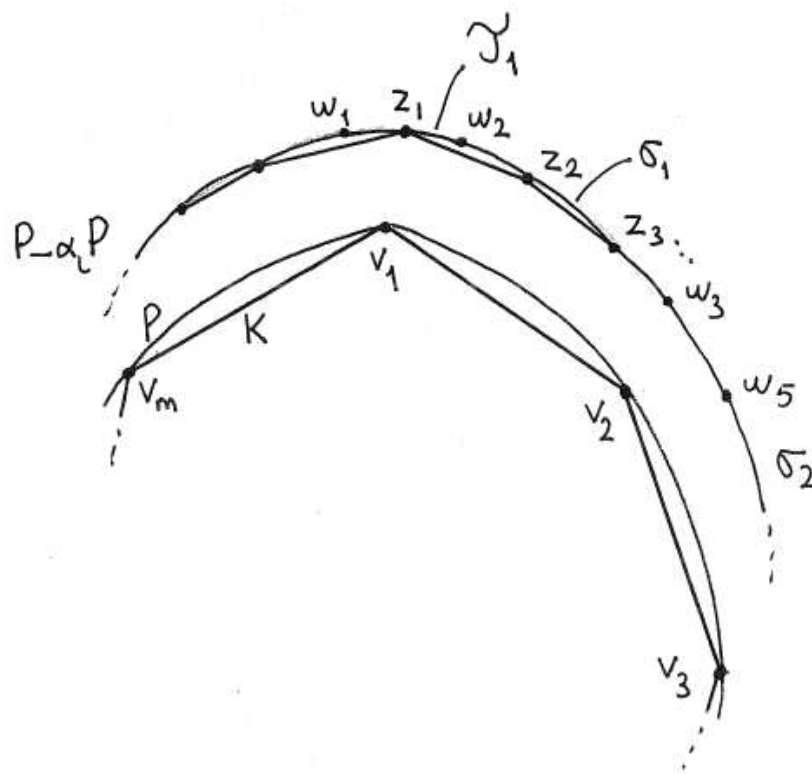

Figure 1.6.5

points by  $d(\cdot, \cdot)$ .

Let  $w_1$  and  $w_2$  be the end points of arc  $\tau_1$ . Here for each  $\tau_i$ , we have  $m$  pairs of end points  $w_j$  and  $w_{j+1}$  where  $i = 1, \dots, m$  and  $i \neq j = 1, \dots, 2m$ .

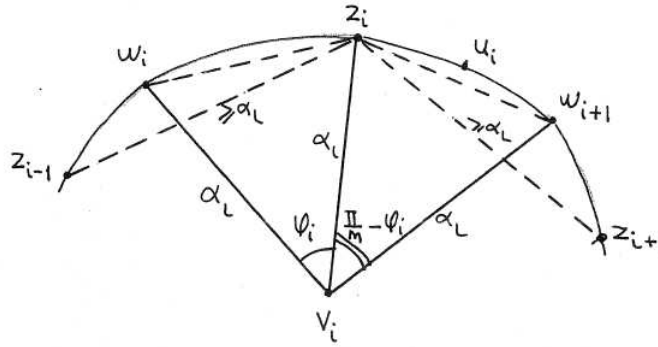

Figure 1.6.6

The distance between consecutive pairs of  $z_i$ 's is  $\alpha_l$  so that the homothetic copies placed on the  $\sigma_i$ 's touch each other as required for the Newton number. Since  $z_{i-1}, z_i, z_{i+1}$  are critical points on the edges of  $\mathcal{P} - \alpha_l \mathcal{P}$ , we need to calculate the lengths of arc  $\widehat{z_{i-1}z_i}$  and arc  $\widehat{z_i z_{i+1}}$  where  $z_i$  is on the arc  $\tau_i$ , and  $z_{i-1}$  ( $z_{i+1}$ ) is on the arc  $\sigma_{i-1}$  (arc  $\sigma_i$ ) respectively.

First we calculate the lengths of arc  $\widehat{z_{i-1}z_i}$  and arc  $\widehat{z_i z_{i+1}}$  in order to calculate the perimeter of  $\mathcal{P} - \alpha_l \mathcal{P}$  and prove that we need less than  $l$  homothetic copies of  $\mathcal{P}$  to place around  $\mathcal{P} - \alpha_l \mathcal{P}$ .

So the calculation of  $\|\text{arc } \widehat{z_{i-1}z_i}\| + \|\text{arc } \widehat{z_i z_{i+1}}\|$  follows:

$$\begin{aligned} \|\text{arc } \widehat{z_{i-1}z_i}\| + \|\text{arc } \widehat{z_i z_{i+1}}\| &= \|\text{arc } \widehat{z_{i-1}w_i}\| + \|\text{arc } \widehat{w_i z_i}\| \\ &\quad + \|\text{arc } \widehat{z_i w_{i+1}}\| + \|\text{arc } \widehat{w_{i+1} z_{i+1}}\| \end{aligned}$$

$$\implies \|\text{arc } \widehat{z_{i-1}z_i}\| + \|\text{arc } \widehat{z_i z_{i+1}}\| > d(z_{i-1}, w_i) + \frac{\pi}{m} \cdot \alpha_l + d(w_{i+1}, z_{i+1})$$

since  $\|\text{arc } \widehat{z_{i-1}w_i}\| > d(z_{i-1}, w_i)$ ,  $\|\text{arc } \widehat{w_{i+1}z_{i+1}}\| > d(w_{i+1}, z_{i+1})$  and  $\|\text{arc } \widehat{w_i z_i}\| + \|\text{arc } \widehat{z_i w_{i+1}}\| = \|\text{arc } \widehat{w_i w_{i+1}}\| = \frac{\pi}{m} \cdot \alpha_l$  as defined above. Now we calculate  $d(z_{i-1}, w_i) + d(w_{i+1}, z_{i+1})$ .

We know that  $d(z_{i-1}, w_i) + d(w_i, z_i) \geq \alpha_l$  and  $d(z_i, w_{i+1}) + d(w_{i+1}, z_{i+1}) \geq \alpha_l$  since it is assumed that  $d(z_{i-1}, z_i) \geq \alpha_l$ . Note that

$$\text{int}(\alpha_l \mathcal{P} + z_{i-1}) \cap \text{int}(\alpha_l \mathcal{P} + z_i) = \emptyset$$

$$\partial(\alpha_l \mathcal{P} + z_{i-1}) \cap \partial(\alpha_l \mathcal{P} + z_i) \neq \emptyset$$

or  $\alpha_l \mathcal{P} + z_{i-1}$  and  $\alpha_l \mathcal{P} + z_i$  are very close as they are placed that way to attain Newton number. So we have the following result:

$$\begin{aligned} d(z_{i-1}, w_i) + d(w_i, z_i) &> d(z_{i-1}, z_i) &&\geq \alpha_l \\ d(z_i, w_{i+1}) + d(w_{i+1}, z_{i+1}) &> d(z_i, z_{i+1}) &&\geq \alpha_l \\ d(z_{i-1}, w_i) + d(w_i, z_i) + d(z_i, w_{i+1}) + d(w_{i+1}, z_{i+1}) &&&\geq 2\alpha_l \\ d(z_{i-1}, w_i) + d(w_{i+1}, z_{i+1}) &&&\geq 2\alpha_l - \left( d(w_i, z_i) + d(z_i, w_{i+1}) \right) \end{aligned} \tag{1.49}$$

Now we find when  $d(w_i, z_i) + d(z_i, w_{i+1})$  takes its maximum. The reason for this is to find out where  $z_i$  can be placed so that the maximum number of homothetic copies,  $\alpha_l \mathcal{P} + z_i$ 's might be placed around  $\mathcal{P}$  as required for the Newton number.

Let  $\varphi_i$  be the angle between  $\overrightarrow{w_i v_i}$  and  $\overrightarrow{z_i v_i}$ . (See Figure 1.6.6). If the sine rule is applied to the triangle  $w_i v_i \triangle z_i$  and  $z_i v_i \triangle w_{i+1}$  respectively, then we have

$$\frac{\alpha_l}{\sin \frac{\pi}{2}} = \frac{d(w_i, z_i)/2}{\sin \frac{\varphi_i}{2}}$$



$$\implies d(w_i, z_i) = 2\alpha_l \sin \frac{\varphi_i}{2}.$$

$$\frac{\alpha_l}{\sin \frac{\pi}{2}} = \frac{d(z_i, w_{i+1})/2}{\sin \left( \frac{\pi}{2m} - \frac{\varphi_i}{2} \right)}$$

$$\implies d(z_i, w_{i+1}) = 2\alpha_l \cdot \sin \left( \frac{\pi}{2m} - \frac{\varphi_i}{2} \right)$$

So we have

$$d(w_i, z_i) + d(z_i, w_{i+1}) = 2\alpha_l \sin \frac{\varphi_i}{2} + 2\alpha_l \sin \left( \frac{\pi}{2m} - \frac{\varphi_i}{2} \right).$$

If we define  $f(\varphi_i) = d(w_i, z_i) + d(z_i, w_{i+1})$ , then

$$f(\varphi_i) = 2\alpha_l \left( \sin \frac{\varphi_i}{2} + \sin \left( \frac{\pi}{2m} - \frac{\varphi_i}{2} \right) \right)$$

$$\text{and } f'(\varphi_i) = 2\alpha_l \left( \frac{1}{2} \cos \frac{\varphi_i}{2} - \frac{1}{2} \cos \left( \frac{\pi}{2m} - \frac{\varphi_i}{2} \right) \right)$$

$$\text{So } f'(\varphi_i) = \alpha_l \left( \cos \frac{\varphi_i}{2} - \cos \left( \frac{\pi}{2m} - \frac{\varphi_i}{2} \right) \right) = 0,$$

$$\text{if } \frac{\varphi_i}{2} = \frac{\pi}{2m} - \frac{\varphi_i}{2},$$

$$\text{i.e. } \varphi_i = \frac{\pi}{2m}.$$

This means that  $f(\varphi_i)$  takes its maximum at  $\varphi_i = \frac{\pi}{2m}$ . Hence there is a point  $u_i$  on the arc  $\widehat{z_i w_{i+1}}$  so that

$$d(w_i, z_i) \leq d(w_i, u_i) \quad \text{and} \quad d(z_i, w_{i+1}) \leq d(u_i, w_{i+1})$$

hold. From these statements, we have

$$\begin{aligned} d(z_{i-1}, w_i) + d(w_{i+1}, z_{i+1}) &\geq 2\alpha_l - \left( d(w_i, z_i) + d(z_i, w_{i+1}) \right), \\ d(z_{i-1}, w_i) + d(w_{i+1}, z_{i+1}) &> 2\alpha_l - \left( d(w_i, u_i) + d(u_i, w_{i+1}) \right) \end{aligned}$$

$$\|\text{arc } \widehat{z_i z_{i+1}}\| = \|\text{arc } \widehat{z_i u_i}\| + \|\text{arc } \widehat{u_i w_{i+1}}\| + \|\text{arc } \widehat{w_{i+1} z_{i+1}}\|$$

$$\|\text{arc } \widehat{z_i z_{i+1}}\| \geq d(z_i, u_i) + \alpha_l \cdot \frac{\pi}{2m} + d(w_{i+1}, z_{i+1}) \quad (1.50)$$

since  $\|\text{arc } \widehat{z_i u_i}\| \geq d(z_i, u_i)$ ,  $\|\text{arc } \widehat{w_{i+1} z_{i+1}}\| \geq d(w_{i+1}, z_{i+1})$  and

$\|\text{arc } \widehat{u_i w_{i+1}}\| = \alpha_l \cdot \frac{\pi}{2m}$ . From the sine rule applied to  $u_i v_i^\Delta w_{i+1}$ ,

$$\frac{\alpha_l}{\sin \frac{\pi}{2}} = \frac{d(u_i, w_{i+1})/2}{\sin \frac{\pi}{4m}}$$

$$d(u_i, w_{i+1}) = 2\alpha_l \sin \frac{\pi}{4m}.$$

$$\begin{aligned} \|\text{arc } \widehat{z_i z_{i+1}}\| &\geq d(z_i, u_i) + \alpha_l \cdot \frac{\pi}{2m} + d(w_{i+1}, z_{i+1}) \\ &d(z_i, u_i) + d(u_i, w_{i+1}) + d(w_{i+1}, z_{i+1}) \geq d(z_i, z_{i+1}) \geq \alpha_l \\ &d(z_i, u_i) + d(w_{i+1}, z_{i+1}) \geq \alpha_l - d(u_i, w_{i+1}) \\ \|\text{arc } \widehat{z_i z_{i+1}}\| &\geq \alpha_l \cdot \frac{\pi}{2m} + \alpha_l - d(u_i, w_{i+1}). \end{aligned}$$

From above, as we know that  $d(u_i, w_{i+1}) = 2\alpha_l \sin \frac{\pi}{4m}$ , we take

$$\|\text{arc } \widehat{z_i z_{i+1}}\| \geq \alpha_l \cdot \frac{\pi}{2m} + \alpha_l - 2\alpha_l \sin \frac{\pi}{4m}$$

$$\text{or } \|\text{arc } \widehat{z_i z_{i+1}}\| \geq \alpha_l \left( \frac{\pi}{2m} - 2 \sin \frac{\pi}{4m} + 1 \right).$$

Here we call  $\Gamma := \frac{\pi}{2m} - 2 \sin \frac{\pi}{4m}$ . Note that  $\Gamma > 0$ . If we suppose not, then we have

$$\frac{\pi}{2m} - 2 \sin \frac{\pi}{4m} < 0 \Rightarrow \frac{\pi}{2m} < 2 \sin \frac{\pi}{4m}.$$

We also know that  $\sin \frac{\pi}{4m} < \frac{\pi}{4m}$ , so

$$\begin{aligned} \frac{\pi}{2m} &< 2 \sin \frac{\pi}{4m} < 2 \cdot \frac{\pi}{4m} \\ \frac{\pi}{2m} &< \frac{\pi}{2m} \end{aligned}$$

is a contradiction. This concludes that  $\Gamma > 0$  holds.

Therefore, there exists a  $\Gamma > 0$ , depending on  $m$ , such that the length of arc  $\widehat{z_i z_{i+1}}$  is at least  $(1 + \Gamma)\alpha_l$ . We denote the perimeter of a convex body by  $Per(\cdot)$ .

Note that the number of vertices of  $\mathcal{P}$  is  $m$  while the number of homothetic copies of  $\mathcal{P}$  placed around  $\mathcal{P}$  is  $l > m$ . So we have  $(l - m)$  homothetic copies which are placed on  $\sigma_i$ 's, and also  $m$  homothetic copies which are placed on  $\tau_i$ 's. See Figure 1.6.5.

We know that

$$Per(\mathcal{P} - \alpha_l \mathcal{P}) = (l - m) \cdot \alpha_l + m \cdot \|\text{arc } \widehat{z_i z_{i+1}}\|$$

and  $\|\text{arc } \widehat{z_i z_{i+1}}\| \geq (1 + \Gamma)\alpha_l$ . So we deduce that

$$\begin{aligned} Per(\mathcal{P} - \alpha_l \mathcal{P}) &\geq (l - m)\alpha_l + m(1 + \Gamma)\alpha_l \\ \Rightarrow Per(\mathcal{P} - \alpha_l \mathcal{P}) &\geq l\alpha_l + m\Gamma\alpha_l. \end{aligned}$$

Hence if  $l$  homothetic copies,  $\alpha_l \mathcal{P} + z_i$ 's, are placed around  $\partial \mathcal{P}$ , i.e.,  $N_{\alpha_l}(\mathcal{P}) \geq l$ , then we have

$$Per(\mathcal{P} - \alpha_l \mathcal{P}) \geq l\alpha_l + m\Gamma\alpha_l.$$

Here we conclude that

$$\text{If } Per(\mathcal{P} - \alpha_l \mathcal{P}) < l\alpha_l + m\Gamma\alpha_l, \text{ then } N_{\alpha_l}(\mathcal{P}) < l. \quad (1.51)$$

The classical theorem, Barbier's Theorem, concerning convex bodies of constant width, states that all convex bodies of constant width  $w$  have perimeter  $\pi.w$ . Since any convex body, say  $\mathcal{L}$ , of diameter 1 is contained in a body of constant width 1, Barbier's Theorem implies that  $Per(\mathcal{L}) \leq \pi$ , with equality if and only if  $\mathcal{L}$  is of constant width 1.

By Barbier's Theorem, we have  $Per(\mathcal{P} - \alpha_l \mathcal{P}) = \pi.w = \pi(1 + \alpha_l)$ . So we try to find  $l$  such that

$$\begin{aligned} \pi(1 + \alpha_k) &< l\alpha_l + m\Gamma\alpha_l \quad \left( m\Gamma = \frac{\pi}{2} - 2m \sin \frac{\pi}{4m} \right) \\ \Leftrightarrow \pi \left( \frac{1}{1 - \sin \frac{\pi}{l}} \right) &< (l + m\Gamma) \cdot \frac{\sin \frac{\pi}{l}}{1 - \sin \frac{\pi}{l}} \\ \Leftrightarrow \pi &< (l + m\Gamma) \sin \frac{\pi}{l} \end{aligned}$$

As  $\sin \left( \frac{\pi}{l} \right) > \frac{\pi}{l} - \frac{\pi^3}{6l^3}$ , it is enough to find  $l$  with  $\pi < (l + m\Gamma) \cdot \left( \frac{\pi}{l} - \frac{\pi^3}{6l^3} \right)$  or  $l$  with  $(6m\Gamma)l^2 - \pi^2 l - \pi^2 m\Gamma > 0$ . This holds for  $l \geq l_0(m) = l_0$ .

By (1.51), we take  $N_{\alpha_l}(\mathcal{P}) \leq l - 1$  for  $l \geq l_0$ .

$$N_{\alpha_l}(\mathcal{P}) < N_{\alpha_l}(D\mathcal{P}) \quad \text{if} \quad \alpha_l = \frac{\sin \frac{\pi}{l}}{1 - \sin \frac{\pi}{l}}$$

for odd number  $l \geq l_0$ .  $\square$

It is in the framework of generalized kissing number that we investigate a counterex-

ample to

$$N_{\alpha_k}(\mathcal{K}) = N_{\alpha_k}(D\mathcal{K}) \iff \mathcal{K} = \mathcal{B}$$

where  $\mathcal{K}$  is any convex body and  $\mathcal{B}$  is the unit circle.

**Theorem 1.7** *There is a convex domain  $\mathcal{K}$  with constant width 1 such that  $\mathcal{K}$  is not a circle but  $N_{\alpha_k}(\mathcal{K}) = k = N_{\alpha_k}(\mathcal{B})$  where  $\mathcal{B}$  is unit circle. Here*

$$\alpha_k = \frac{\sin \frac{\pi}{k}}{1 - \sin \frac{\pi}{k}} \quad \text{for } k = 7, 8, 9, \dots$$

*is the scaling factor of homothetic copies of  $\mathcal{K}$  and  $\mathcal{B}$ .*

**Proof of 1.7**

Here  $\mathcal{K}$  is a convex body with constant width 1 and  $\mathcal{B}$  is the unit circle. Note that  $\mathcal{K}$  will be constructed with other properties in the proof. As in Theorem 1.7,  $D\mathcal{K}$  is the unit circle since the sum of an arbitrary convex curve of constant width 1 with the same curve turned through  $180^\circ$  is a circle of radius 1, i.e.,  $D\mathcal{K} = \mathcal{B}$ . We choose  $\alpha_k > 0$  so that  $k$  non-overlapping circles of radius  $\alpha_k$ ,  $\alpha_k D\mathcal{K} + x_i$  ( $i = 1, \dots, k$ ), can be placed around the unit circle  $D\mathcal{K}$ , in such a way that each touches the unit circle and its two neighbours.

From the sine rule applied to the triangle in Figure 1.7.1, as  $\underline{OA}$  is chosen to be the angular bisector of  $\angle x_i \underline{O} x_{i+1} = 2\frac{\pi}{k}$ ,

$$\frac{1 + \alpha_k}{\sin \frac{\pi}{2}} = \frac{\alpha_k}{\sin \frac{\pi}{k}}$$

$$\alpha_k = \frac{\sin \frac{\pi}{k}}{1 - \sin \frac{\pi}{k}}.$$

So if  $N_{\alpha_k}(D\mathcal{K}) = k$ , then we must choose

$$\alpha_k = \frac{\sin \frac{\pi}{k}}{1 - \sin \frac{\pi}{k}}$$

where  $k = 7, 8, 9, \dots$  so  $\alpha_k < 1$ .

We will now prove that

$$N_{\alpha_k}(\mathcal{K}) = k \text{ for } \alpha_k = \frac{\sin \frac{\pi}{k}}{1 - \sin \frac{\pi}{k}}$$

as calculated above.

First we will prove that  $N_{\alpha_k}(\mathcal{K}) \leq k$ . Let  $y_1, \dots, y_m$  be the centres of the homothetic copies of  $\mathcal{K}$ ,  $\alpha_k \mathcal{K} + y_i$  ( $i = 1, \dots, m$ ).

We know that

$$N_{\alpha_k}(\mathcal{K}) := \max \{ m \mid \exists y_1, \dots, y_m \in \partial(\mathcal{K} - \alpha_k \mathcal{K}) \text{ such that } d(y_i, y_j) \geq \alpha_k \}.$$

We assume that  $N_{\alpha_k}(\mathcal{K}) \geq k + 1$  and then we will obtain a contradiction which proves  $N_{\alpha_k}(\mathcal{K}) \leq k$ .

Since we assumed that  $N_{\alpha_k}(\mathcal{K}) \geq k + 1$ , we can place as many copies as we like without other conditions. Note that  $\mathcal{K} - \alpha_k \mathcal{K}$  is a convex body with constant width  $1 + \alpha_k$ .

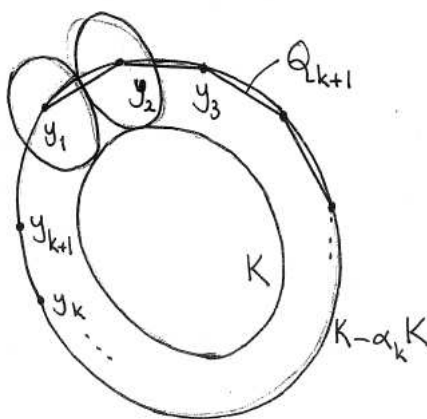

Figure 1.7.1

Let  $\mathcal{Q}_{k+1}$  be the convex hull of  $y_1, \dots, y_{k+1}$ ;  $\mathcal{Q}_{k+1} := \text{conv}\{y_1, \dots, y_{k+1}\} \subseteq \mathcal{K} - \alpha_k \mathcal{K}$ . See figure 1.7.1. We denote the diameter of a convex body by  $\text{diam}(\cdot)$ . Since  $\mathcal{Q}_{k+1} \subseteq \mathcal{K} - \alpha_k \mathcal{K}$ ,

$$\text{diam}(\mathcal{Q}_{k+1}) \leq \text{diam}(\mathcal{K} - \alpha_k \mathcal{K}) = 1 + \alpha_k \quad (1.52)$$

holds. Furthermore; since  $\forall y_i, d(y_i, y_{i+1}) \geq \alpha_k$ , we have

$$\text{Per}(\mathcal{Q}_{k+1}) \geq (k+1)\alpha_k. \quad (1.53)$$

Let  $D\mathcal{Q}_{k+1}$  be the difference body of  $\mathcal{Q}_{k+1}$ . Namely,

$$D\mathcal{Q}_{k+1} := \frac{1}{2}(\mathcal{Q}_{k+1} - \mathcal{Q}_{k+1}).$$

$D\mathcal{Q}_{k+1}$  has at most  $2(k+1)$  sides and is centrally symmetric. (See figure 1.7.2).

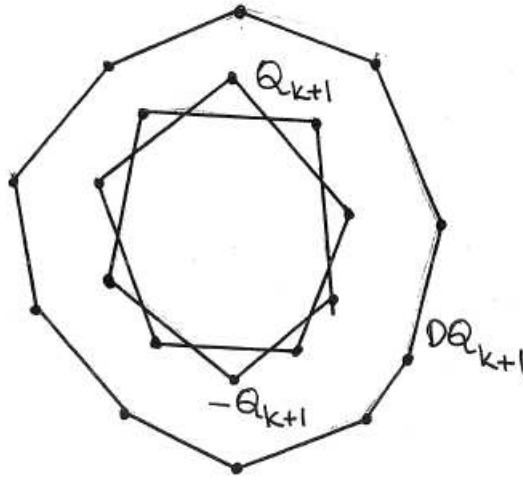

Figure 1.7.2

Note that for any convex body  $\mathcal{K}$  in  $\mathbb{R}^n$   $\text{diam}(D\mathcal{K}) = 2 \text{diam}(\mathcal{K})$ . From this statement together with (1.52), we have

$$\text{diam}(D\mathcal{Q}_{k+1}) = 2 \text{diam}(\mathcal{Q}_{k+1}) \leq 2(1 + \alpha_k). \quad (1.54)$$

We also know that  $Per(DQ_{k+1}) > Per(Q_{k+1})$ . So from (1.53),

$$Per(DQ_{k+1}) > Per(Q_{k+1}) \geq 2(k+1)\alpha_k. \quad (1.55)$$

Briefly, the difference body  $DQ_{k+1}$  has the following properties:

- (i)  $DQ_{k+1}$  has at most  $2(k+1)$  sides.
- (ii)  $DQ_{k+1}$  is centrally symmetric.
- (iii)  $Per(DQ_{k+1}) > 2(k+1)\alpha_k$ .
- (iv)  $diam(DQ_{k+1}) \leq 2(1+\alpha_k)$ .

From (ii) and (iv), we have

$$DQ_{k+1} \subseteq 2(1+\alpha_k)\mathcal{B}.$$

We know that “If any  $n$ -gon is contained in a circular disc, then the perimeter is maximized by the regular  $n$ -gon inscribed in the disc.” This implies that

$$Per(DQ_{k+1}) \leq Per(Q), \quad (1.56)$$

where  $Q$  is the regular  $2(k+1)$ -gon inscribed in  $(1+\alpha_k)\mathcal{B}$ .

Let  $\phi$  be the angle between  $\underline{Oy}'_i$  and  $\underline{Oy}'_{i+1}$  where  $y'_i$  ( $y'_{i+1}$ ) is the transformation of  $y_i$  ( $y_{i+1}$ ) onto  $Q$ . (See Figure 1.7.3).

So we have the following calculation:

$$\begin{aligned} \frac{d(y'_i, y'_{i+1})/2}{\sin \frac{\pi}{2(k+1)}} &= \frac{1+\alpha_k}{\sin \frac{\pi}{2}} \\ d(y'_i, y'_{i+1}) &= 2(1+\alpha_k) \sin \frac{\pi}{2(k+1)}. \end{aligned}$$



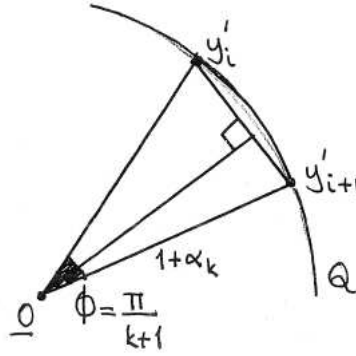

Figure 1.7.3

From (1.56), we have  $Per(DQ_{k+1}) \leq Per(Q)$  and we also know that

$$Per(Q) = 2(k+1) d(y'_i, y'_{i+1})$$

since  $Q$  is the regular  $2(k+1)$ -gon inscribed in  $B$  with the property

$$d(y'_i, y'_{i+1}) = 2(1 + \alpha_k) \sin \frac{\pi}{2(k+1)}.$$

From the property (iii) of  $DQ_{k+1}$ ,

$$2(k+1) \alpha_k < Per(DQ_{k+1}).$$

From the above statements,

$$\begin{aligned} 2(k+1) \alpha_k < Per(DQ_{k+1}) &\leq Per(Q) = 2(k+1) \cdot 2(1 + \alpha_k) \sin \frac{\pi}{2(k+1)} \\ \frac{\alpha_k}{1 + \alpha_k} &\leq 2 \sin \frac{\pi}{2(k+1)}. \end{aligned}$$

Here  $\frac{\alpha_k}{1 + \alpha_k} = \sin \frac{\pi}{k}$ . Together with the above statement, this leads to  $\sin \frac{\pi}{k} \leq 2 \sin \frac{\pi}{2(k+1)}$ .

Since we know  $t - \frac{t^3}{6} < \sin t < t$ ,

$$\frac{\pi}{k} - \frac{\pi^3}{6k^3} < \sin \frac{\pi}{k} \leq 2 \sin \frac{\pi}{2(k+1)} < 2 \frac{\pi}{2(k+1)}$$

$$\frac{\pi}{k} - \frac{\pi}{k+1} < \frac{\pi^3}{6k^3}$$

$$\frac{(k+1)\pi - k\pi}{k(k+1)} < \frac{\pi^3}{6k^3}$$

$$\pi \cdot 6k^3 < \pi^3 k(k+1)$$

$$6k^2 < \pi^2(k+1)$$

$$0.60 \cong \frac{6}{\pi^2} < \frac{k+1}{k^2} < 0.45 \quad (1.57)$$

since  $k \geq 3$ . So (1.57) gives a contradiction to our assumption  $N_{\alpha_k}(\mathcal{K}) > k$ . As a result,

$$N_{\alpha_k}(\mathcal{K}) \leq k$$

holds for any convex body  $\mathcal{K}$  with constant width 1.

Now we will prove that  $N_{\alpha_k}(\mathcal{K}) \geq k$  holds for the constructed  $\mathcal{K}$  as explained below.

Here we have two cases depending on  $k$  being even or odd:

- i.  $k$  is even ( $k=8, 10, \dots$ ):** Let  $\mathcal{P}_k$  be a regular  $k$ -gon inscribed in  $\mathcal{B}$ . Let  $\mathcal{L}$  be a convex body with diameter 1 and containing an arc of radius 1. Let  $\mathcal{K}$  be the convex body of constant width 1 such that  $\mathcal{L} \subset \mathcal{K} \neq \mathcal{B}$  and  $\mathcal{P}_k \subset \mathcal{K}$ . So  $\mathcal{K}$  is the convex body with constant width 1 with the property that it has an arc of radius 1.

Since  $\mathcal{P}_k$  is a regular  $k$ -gon,  $\mathcal{P}_k = -\mathcal{P}_k$ . We conclude that

$$-\mathcal{P}_k = \mathcal{P}_k \subset \mathcal{K}$$

$$\implies (1 + \alpha_k)\mathcal{P}_k \subset \mathcal{K} - \alpha_k\mathcal{K}.$$

Let  $z_1, \dots, z_k$  be the centres of the homothetic copies  $\alpha_k\mathcal{K} + z_i (i = 1, \dots, k)$  on  $\partial(\mathcal{K} - \alpha_k\mathcal{K})$ . (See Figure 1.7.4).

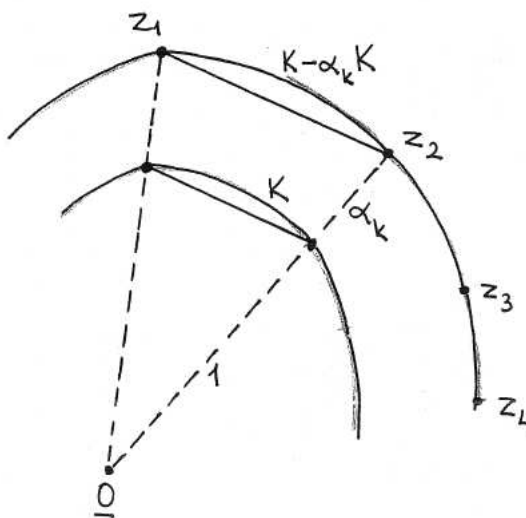

Figure 1.7.4

We take the arc  $\widehat{z_1 z_2}$  of radius 1, and the calculation of  $\|\widehat{arc z_1 z_2}\|$  follows:

$$\frac{d(z_1, z_2)/2}{\sin \frac{\pi}{k}} = \frac{1 + \alpha_k}{\sin \frac{\pi}{2}}$$

$$d(z_1, z_2) = 2(1 + \alpha_k) \sin \frac{\pi}{k}.$$

$$\implies 1 + \alpha_k = \frac{d(z_1, z_2)}{2 \sin \frac{\pi}{k}}$$

We know that  $\sin \frac{\pi}{k} = \frac{\alpha_k}{1 + \alpha_k}$ . So from the above statement, we have

$$\sin \frac{\pi}{k} = \frac{2 \alpha_k \sin \frac{\pi}{k}}{d(z_1, z_2)}$$

$$\implies d(z_1, z_2) = 2\alpha_k.$$

which means we need more than  $k$  homothetic copies  $\alpha_k \mathcal{K} + z_i$  to find the Newton number for  $\mathcal{K}$ .

$$\implies N_{\alpha_k}(\mathcal{K}) \geq k \text{ if } k \text{ is even}$$

where  $k = 8, 10, \dots$

**ii.  $k$  is odd:** In this case, we consider  $\mathcal{P}_{2k}$  and by taking every second vertex of  $\mathcal{P}_{2k}$ , we repeat the same proof in the case **i**.

$$\implies N_{\alpha_k}(\mathcal{K}) \geq k \text{ if } k \text{ is odd.}$$

This concludes the proof.  $\square$

## 1.6 Upper and Lower Bound for $B_1$

In 1999, when we worked on this problem with C. A. Rogers, he reminded us that the upper bound for covering the ball can be used for the unrestricted blocking number. In this section, we give an upper and a lower bound for the unrestricted blocking number,  $B_1(\mathcal{B}^n)$ , for  $n$ -dimensional ball with  $n \geq 9$ .

**Theorem 1.8** *Let  $\mathcal{B}^n$  be  $n$ -dimensional ball with  $n \geq 9$ . Then*

$$\begin{aligned} n^{-3/2} \left( \frac{2}{\sqrt{3}} \right)^{n-2} &\leq B_1(\mathcal{B}^n) \\ &< \frac{4\sqrt{n} \left( \frac{2}{\sqrt{3}} \right)^n}{\left( 1 - \frac{2}{\log n} \right)} \left( n \log n + n \log \log n + n \log \left( \frac{2}{\sqrt{3}} \right) + \frac{1}{2} \log 16n \right). \end{aligned}$$

**Proof of 1.8**

In the theorem 1.4, we gave the following result for  $B_1$ :

$$B_1(\mathcal{C}) \geq n^{-3/2} \left(1 - m(\mathcal{C})\right)^{2-n} \quad (1.58)$$

where  $\mathcal{C}$  is an  $n$ -dimensional centrally symmetric convex body with M-curvature  $m(\mathcal{C})$ .

For the definition of M-curvature, see page 65.

From this, we will show that

$$B_1(\mathcal{B}^n) \geq n^{-3/2} \left(\frac{2}{\sqrt{3}}\right)^{n-2}$$

for  $n$ -dimensional ball,  $\mathcal{B}^n$  where  $n \geq 9$ .

Now we show that M-curvature of  $\mathcal{B}^n$  ( $n \geq 9$ ) is  $1 - \frac{\sqrt{3}}{2}$ . Since M-curvature,  $m(\mathcal{B}^n)$  is

the minimum of  $\left(1 - \frac{d(\underline{O}, L(\underline{x}, \underline{y}))}{d(\underline{O}, T(\underline{x}, \underline{y}))}\right)$ , we obtain  $\mu\mathcal{B}^n \subset \mathcal{B}^n$  such that

$$m(\mathcal{B}^n) = \min \left(1 - \frac{d(\underline{O}, L(\underline{x}, \underline{y}))}{d(\underline{O}, T(\underline{x}, \underline{y}))}\right) = \min (1 - \mu) = 1 - \max \mu$$

where  $x, y \in \partial\mathcal{B}^n$ . From the Figure 1.8.1 where  $\max \mu = \frac{\sqrt{3}}{2}$  and  $2a = 1$ , it is a triviality that  $m(\mathcal{B}^n) = 1 - \frac{\sqrt{3}}{2}$  for ( $n \geq 9$ ).

So M-curvature of  $\mathcal{B}^n$  is as follows:

$$m(\mathcal{B}^n) = 1 - \frac{\sqrt{3}}{2}. \quad (1.59)$$

From (1.58) and (1.59), we have the following upper bound for  $B_1(\mathcal{B}^n)$ :

$$B_1(\mathcal{B}^n) \geq \frac{1}{n^{\frac{3}{2}}} \left(\frac{2}{\sqrt{3}}\right)^{n-2}.$$

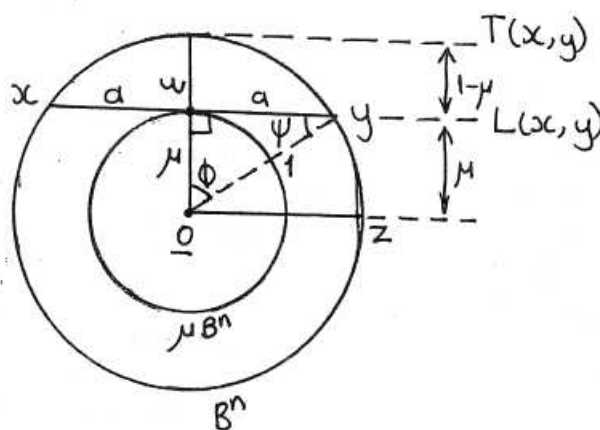

Figure 1.8.1

Briefly, we know that for  $B^n$ , M-curvature  $m(B^n)$  takes its minimal when  $\mu = \frac{\sqrt{3}}{2}$ . If  $\mu > \frac{\sqrt{3}}{2}$ , then we have the ratio is less than 1;  $\frac{a+b}{r} < 1$ . (See Figure 1.8.2a).

Similarly, if  $\mu < \frac{\sqrt{3}}{2}$ , then we have  $\frac{a+b}{r} > 1$  as can be seen from figure 1.8.2b.

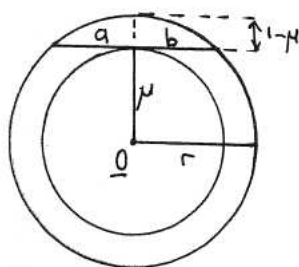

Figure 1.8.2a

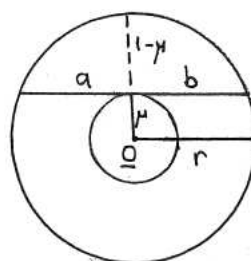

Figure 1.8.2b

Observing these results, an obvious conjecture arises:

**Conjecture 1.6.1** *Let  $C$  be an  $n$ -dimensional centrally symmetric convex body with*

$M$ -curvature,  $m(\mathcal{C})$ . The  $M$ -curvature satisfies

$$m(\mathcal{C}) \geq \frac{\sqrt{3}}{2}$$

where  $m(\mathcal{C})$  takes its maximum.

However; we have a counterexample, 10-gon for this conjecture. In fact, not only 10-gon, but also all regular  $2(6r + 1)$  and  $2(6r + 5)$ -gons are counterexamples where  $r > 0$  is an integer. This has been proven by aid of computer. Furthermore; amongst all these regular  $k$ -gons, where  $k = 2(6r + 1), 2(6r + 5)$ , 10-gon is the extremal.

Together with these bounds, it is worth mentioning the following upper bound. In high dimensions, the following bounds for  $m(\mathcal{C})$  are given in the paper of L. Dalla, D. G. Larman, P. Mani-Levitska and C. M. Zong [4].

$$0 \leq m(\mathcal{C}) \leq 1 - \frac{\sqrt{3}}{2} + \epsilon.$$

Now we will prove that

$$B_1(\mathcal{B}^n) < \frac{4\sqrt{n}\left(\frac{2}{\sqrt{3}}\right)^n}{\left(1 - \frac{2}{\log n}\right)} \left( n \log n + n \log \log n + n \log \left( \frac{2}{\sqrt{3}} \right) + \frac{1}{2} \log 16n \right).$$

In 1963, C. A. Rogers [8] showed the following upper bound for spheres:

If  $R > 1$ ,  $n \geq 9$  and  $N$  is an integer with

$$N\theta_R \geq \left( n \log n + n \log \log n + n \log R + \frac{1}{2} \log (16n) \right) \left( 1 - \frac{2}{\log n} \right)^{-1} \quad (1.60)$$

where  $\theta_R$  is the proportion of the surface of the sphere of radius  $R$  covered by one of its spherical caps of chord 2, then the surface of the sphere of radius  $R$  can be covered by  $N$  spherical caps of chord 2.

The idea in this theorem is to cover the surface,  $\Sigma$ , of the sphere of the radius  $R$  by  $N$  spherical caps of chord 2. If we apply this idea to the unrestricted blocking number, we will have the following findings:

The surface,  $\partial(2\mathcal{B}^n)$ , of the sphere,  $2\mathcal{B}^n$ , of radius,  $\frac{2}{\sqrt{3}}$ , can be covered by  $N$  spherical caps of chord 2. From the same paper, it is known that the proportion of the surface  $\partial 2\mathcal{B}^n$  covered by one of its caps of chord 2,  $\theta_R > 1/(4R^n \sqrt{n})$ . Here  $\theta$  will be

$$\theta_R > \frac{1}{4\left(\frac{2}{\sqrt{3}}\right)^n \sqrt{n}}.$$

So from (1.60),

$$N \geq \frac{4\sqrt{n}\left(\frac{2}{\sqrt{3}}\right)^n}{\left(1 - \frac{2}{\log n}\right)} \left( n \log n + n \log \log n + n \log \left(\frac{2}{\sqrt{3}}\right) + \frac{1}{2} \log 16n \right).$$

Here we have  $N$  caps which can be represented by  $2\mathcal{B}^n \cap \text{int}(2\mathcal{B}^n + x_i)$  where  $i = 1, 2, \dots, N$ . These  $N$  translates are enough to block  $\mathcal{B}^n$ . The proof of C.A. Rogers show that the translates do not have to touch  $\mathcal{B}^n$  and are allowed to overlap each other. Since the translates are used to cover  $\partial(2\mathcal{B}^n)$ ,  $\text{int}(\mathcal{B}^n + x_i) \cap \text{int}(\mathcal{B}^n + x_j) \neq \emptyset$   $\partial(\mathcal{B}^n) \cap \partial(\mathcal{B}^n + x_i) = \emptyset$  are allowed for any  $i \neq j$ . In the proof, we take the translates  $\partial(2\mathcal{B}^n + x_i) \cap \partial(2\mathcal{B}^n + x_j) \neq \emptyset$  but  $\text{int}(2\mathcal{B}^n + x_i) \cap \text{int}(2\mathcal{B}^n + x_j)$  could be empty, and this would not change the proof.

So the smallest number of translates of  $\mathcal{B}^n$  which may be contact with  $\mathcal{B}^n$  but prevents any other translates of  $\mathcal{B}^n$  from touching  $\mathcal{B}^n$  is  $N$ , i.e.,  $B(\mathcal{B}^n) = N$ . This finally completes the proof.  $\square$



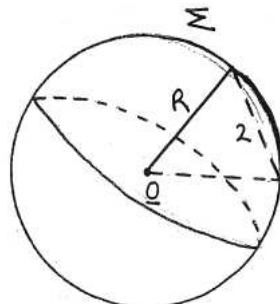

Figure 1.8.3

## 1.7 The Applications of the Unrestricted Blocking Number

We have studied the unrestricted blocking number,  $B_\alpha(\cdot)$  from different angles in the previous sections. Our discussion of  $B_\alpha(\cdot)$  in this section includes much of the applications of the subject.

*“How must the  $n$  given points be placed on the surface of a sphere so that the smallest separation between these points will be as large as possible?”*

This packing problem was raised by the Dutch botanist P. M. L. Tammes [13] in 1930 for the first time. He examined the outside formation of spherical pollen grains and was particularly interested in the distribution of the openings on the surface. He immediately noticed that there is an inclination for these openings to be scattered as far as possible from each other. Then, he suggested the above-mentioned problem.

This particular packing problem can be rephrased as follows:

*“How must  $n$  equal non-overlapping circles be packed on a sphere so that the angular radius of the circles will be as large as possible?”*

As a dual counterpart, the covering problem is:

*“How must a sphere be covered by  $n$  equal overlapping circles so that the angular radius of the circles will be as small as possible?”*

The packing and covering problems have come to the attention of numerous eminent mathematicians. An immense survey of literature was given by L. Fejes Toth [14] in 1972 and H. T. Croft, K. J. Falconer and R. K. Guy [15] in 1991. Since P. M. L. Tammes first raised the problem, the connection is made between this problem and biological structures including the small spherical viruses. Biological structures consisting of a closed shell built from repeated copies of a given subunit must conform to certain geometrical and topological requirements. Examination of the types of shell can give clues to the mathematical rules that represent the physical constraints for building. See Tarnai [16].

In P. W. Fowler and T. Tarnai [17], it is given that there is a correspondence between the topology of arrangements found in solutions and conjectured solutions of the covering problem and many distinct physical, chemical and biological structural problems, for example: boron hydrides, hollow carbon clusters, clathrin cages of coated cages of coated vesicles, brochomes, cocoliths, cones of some cupressus species, carbonyls, fullerenes, certain metal alloys, soap film cones, coated vesicles and bubbles in foam.

There are also some other practical application of the covering problem in daily life. H. Meschkowski [18] interpreters the covering problem as follows:

*“How should  $n$  fuel depots be arranged on a planet so that an accidental explosion of one of them should least endanger the rest?”*

*“How should the residences of  $n$  allied dictators, governing on a planet be placed so as to control the planet as well as possible?”*

In this theorem, we apply the above-mentioned covering problem to the unrestricted blocking number and by using solutions and conjectured solutions of the covering problem, we define the smallest radius,  $\alpha$  of homothetic copies so that  $B_\alpha(\mathcal{B}^3) = k$  for specific  $k$ 's.

The best coverings of a unit ball,  $\mathcal{B}^3$ , by  $k$  number of equal circles,  $r_k\mathcal{B}^3$  of radius  $r_k$  has been given by L. Fejes Tóth [9] in 1943 for  $k = 2, 3, 4, 6, 12$ . When this particular covering problem is applied to the unrestricted blocking number, one achieves the best blocking arrangement for a unit ball,  $\mathcal{B}^3$ , given by  $k$  homothetic copies,  $\alpha\mathcal{B}^3 + x_i$ , of radius  $\alpha$ .

Briefly, to any arrangement of  $k$  equal circles on the sphere there corresponds a polyhedron with  $k$  vertices, defined by the circle centres, and with edges joining the centres of the two circles having a point or points in common (i.e. circles that touch or overlap).

**Theorem 1.9** *Let  $\mathcal{B}^3$  be a 3-dimensional ball. For given unrestricted blocking number,  $B_\alpha(\mathcal{B}^3) = k$ , the smallest radius  $\alpha$  of homothetic copies of  $\mathcal{B}^3$ ,  $\alpha\mathcal{B}^3 + x_i$ 's, where  $i = 1, \dots, k$ , is shown in the following table where*

$$\alpha = \frac{\sin\left(\frac{r_k}{2}\right)}{1 - \sin\left(\frac{r_k}{2}\right)}$$

*and  $r_k$  is the angular radius of the translate  $\alpha\mathcal{B}^3 + x_k$ .*

| $k$ | Radius $r_k$<br>( $\circ$ ) | Radius $\alpha$ | Reference                        |
|-----|-----------------------------|-----------------|----------------------------------|
| 2   | 90.000 000                  | 2.414 213       | Fejes Tóth [9]                   |
| 3   | 90.000 000                  | 2.414 213       | Fejes Tóth [9]                   |
| 4   | 70.528 779                  | 1.366 025       | Fejes Tóth [9]                   |
| 5   | 63.434 949                  | 1.108 508       | Schütte [10]                     |
| 6   | 54.735 610                  | 0.850 826       | Fejes Tóth [9]                   |
| 7   | 51.026 553                  | 0.756 605       | Schütte [10]                     |
| 10  | 42.307 827                  | 0.564 637       | Jucovič [11], G. Fejes Tóth [12] |
| 12  | 37.377 368                  | 0.471 509       | Fejes Tóth [9]                   |
| 14  | 34.937 927                  | 0.428 957       | G. Fejes Tóth [12]               |

Table 1.1: The Unrestricted Blocking Number of the Ball

Here for example,

$$B_\alpha(B^3) = 6 \Leftrightarrow 0.850\,826 \leq \alpha \leq 1.108\,508.$$

Furthermore, for given

$$k = 8, 9, 11, 13, 15 - 20, 22, 26, 32, 38, 42, 50, 72, 122, 132;$$

the lower bound for the smallest radius  $\alpha$  of  $k$  homothetic copies can be given as follows:

$$\alpha > \frac{\sin\left(\frac{1}{2} \arccos\left(\frac{1}{\sqrt{3}} \cot \frac{k\Pi}{6(k-2)}\right)\right)}{1 - \sin\left(\frac{1}{2} \arccos\left(\frac{1}{\sqrt{3}} \cot \frac{k\Pi}{6(k-2)}\right)\right)}.$$

So for example,

$$B_\alpha(B^3) = 8 \Leftrightarrow 0.652\,703 < \alpha < 0.756\,605.$$

**Proof of 1.9**

Now we define the homothetic copies of  $\mathcal{B}^3$ ,  $\alpha\mathcal{B}^3 + x_i$  and  $r'_k\mathcal{B}^3 + x'_i$ . The best covering of  $\mathcal{B}^3$ , by  $k$  equal circles  $r_k\mathcal{B}^3$  is defined by mathematicians given below. We take the covering  $\{r_k\mathcal{B}^3 + x'_i : i = 1, \dots, k\}$ , and define  $\{\alpha\mathcal{B}^3 + x_i : i = 1, \dots, k\}$  as follows: Let  $r_k$  ( $r'_k$ ) be the angular radius (radius) of the circles  $r_k\mathcal{B}^3$  respectively. Let  $x'_i$  be the centre of  $r_k\mathcal{B}^3$ . See Figure 1.11.1. Let  $x_i$  be the centre of these homothetic copies,  $\alpha\mathcal{B}^3 + x_i$  of  $\mathcal{B}^3$  such that  $x_i$ 's are to be placed on  $\partial((1 + \alpha)\mathcal{B}^3)$  and  $\|x_i - x'_i\| = \alpha$ . Note that  $x_i, x'_i$  and  $O$  are collinear. Let  $\mathcal{A}'$  be the point of  $\partial(r_k\mathcal{B}^3) \cap \partial(\mathcal{B}^3)$  such that  $\|\mathcal{A}' - x'_i\| = r'_k$ . Let  $\mathcal{A}$  be on  $\partial((1 + \alpha)\mathcal{B}^3) \cap \partial(2\alpha\mathcal{B}^3 + x_i)$  such that  $\|\mathcal{A} - \mathcal{A}'\| = \alpha$ .

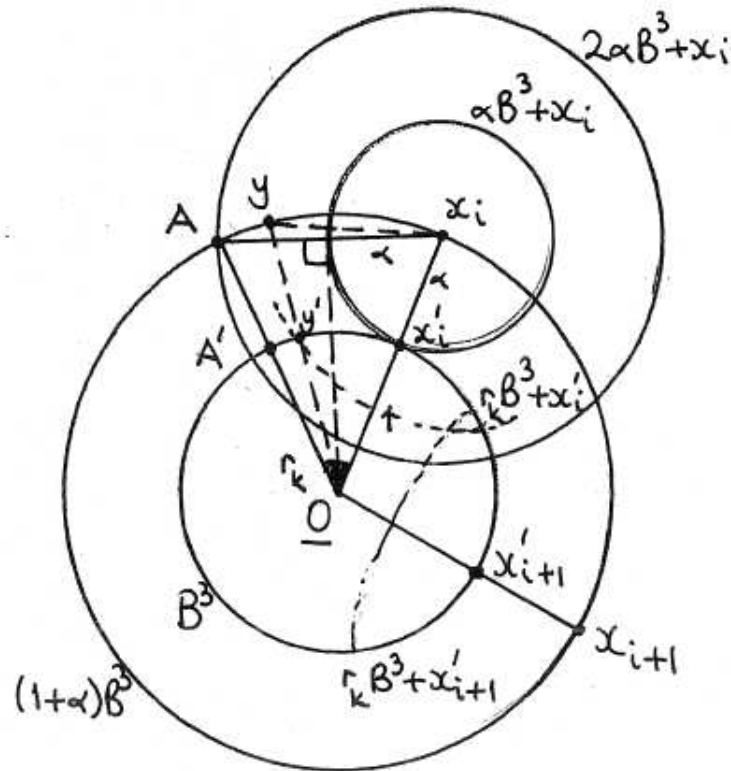

Figure 1.9.1

From the covering problem, we know that  $\partial\mathcal{B}^3$  is covered by the circles  $r_k\mathcal{B}^3$ ; so

$$\partial\mathcal{B}^3 \subset \bigcup_{i=1}^k \text{int} (r_k\mathcal{B}^3 + x'_i).$$

Now we assume that  $\{\alpha\mathcal{B}^3 + x_i : i = 1, \dots, k\}$  is a blocking set for  $\mathcal{B}^3$  so that  $\partial((1 + \alpha)\mathcal{B}^3)$  is covered by  $\text{int} (2\alpha\mathcal{B}^3 + x_i)$ 's ( $i = 1, \dots, k$ ), i.e.,

$$\partial((1 + \alpha)\mathcal{B}^3) \subset \bigcup_{i=1}^k \text{int} 2\alpha\mathcal{B}^3 + x_i.$$

By assuming this statement, we find for which  $\alpha$ 's, the statement is satisfied.

As  $\|A' - x'_i\| = r'_k$ , from the sin rule in Figure 1.9.1, we have

$$\begin{aligned} \frac{r'_k}{2} &= \sin\left(\frac{r_k}{2}\right) \\ \Rightarrow r_k &= 2 \arcsin\left(\frac{r'_k}{2}\right). \end{aligned} \quad (1.61)$$

Again if we apply the sin rule to the triangle  $Ax_i\triangle Q$ ,

$$\begin{aligned} \frac{1 + \alpha}{\sin\left(\frac{\pi}{2}\right)} &= \frac{\alpha}{\sin\left(\frac{r_k}{2}\right)} \\ \Rightarrow \alpha &= \frac{\sin\left(\frac{r_k}{2}\right)}{1 - \sin\left(\frac{r_k}{2}\right)}. \end{aligned} \quad (1.62)$$

From (1.61) and (1.62),

$$\begin{aligned} \alpha &= \frac{\sin\left(\frac{r_k}{2}\right)}{1 - \sin\left(\frac{r_k}{2}\right)} \\ \alpha &= \frac{\sin\left(\arcsin\left(\frac{r'_k}{2}\right)\right)}{1 - \sin\left(\arcsin\left(\frac{r'_k}{2}\right)\right)} \\ \alpha &= \frac{\frac{r'_k}{2}}{1 - \frac{r'_k}{2}}. \end{aligned} \quad (1.63)$$

Since we assume that  $\{\alpha\mathcal{B}^3 + x_i : i = 1, \dots, k\}$  is the blocking configuration for  $\mathcal{B}^3$ , we know that

$$\partial\left((1 + \alpha)\mathcal{B}^3\right) \subset \bigcup_{i=1}^k \text{int}(2\alpha\mathcal{B}^3 + x_i)$$

which means

$$B_\alpha(\mathcal{B}^3) = k \quad \text{holds for} \quad \alpha = \frac{r'_k}{2 - r'_k}.$$

We also know from the covering problem,

$$\partial\mathcal{B}^3 \subset \bigcup_{i=1}^k \text{int}(r_k\mathcal{B}^3 + x'_i)$$

for given  $k$ . Now we should check that

$$\text{When} \quad \partial\mathcal{B}^3 \subset \bigcup_{i=1}^k \text{int}(r_k\mathcal{B}^3 + x'_i), \quad \partial\left((1 + \alpha)\mathcal{B}^3\right) \subset \bigcup_{i=1}^k \text{int}(2\alpha\mathcal{B}^3 + x_i) \quad \text{holds.}$$

In order to prove this, it is sufficient to show that:

$$\forall y \in \partial\left((1 + \alpha)\mathcal{B}^3\right), \exists \text{int}(2\alpha\mathcal{B}^3 + x_i) \text{ such that } y \in \text{int}(2\alpha\mathcal{B}^3 + x_i).$$

(See Figure 1.9.1). We define  $y' := \overrightarrow{Oy} \cap \partial\mathcal{B}^3$ . Since  $\mathcal{B}^3$  is a 3-dimensional ball, when  $y' \in \partial\mathcal{B}^3$ , then  $\|y'\| = 1$  holds. When we take  $y' \in \partial\mathcal{B}^3$  such that  $\|y' - y\| = \alpha$ , we have  $\|y\| = 1 + \alpha$ . This means that we can take  $y \in \partial\left((1 + \alpha)\mathcal{B}^3\right)$  while  $y' \in \partial\mathcal{B}^3$ . So for every  $y \in \partial\left((1 + \alpha)\mathcal{B}^3\right)$ , we can get  $y' \in \partial\mathcal{B}^3$  such that  $\|y' - y\| = \alpha$ .

Let  $D(x'_i, \alpha)$  be the great circle of  $\text{int}(\alpha\mathcal{B}^3 + x'_i)$  with centre  $x'_i$  and radius  $\alpha$ . Since  $x_i \in \partial\left((1 + \alpha)\mathcal{B}^3\right)$  and  $x'_i \in \partial\mathcal{B}^3$ , we have that  $\|x'_i - x_i\| = \alpha$ . (See Figure 1.9.1).

Since  $x'_i \in \partial\mathcal{B}^3$  is the centre of  $r_k\mathcal{B}^3$  and  $y' \in \widehat{Ax'_i} \subset \partial\mathcal{B}^3$ ,  $\|x'_i - y'\| < r'_k$ . It is also known that

$$\alpha = \frac{r'_k}{2 - r'_k} \quad \Rightarrow \quad r'_k = \frac{2\alpha}{1 + \alpha}.$$

$$\text{So } \|x'_i - y'\| < r'_k = \frac{2\alpha}{1 + \alpha}.$$

Let  $\varphi$  be the angle between  $\overrightarrow{Oy'}$  and  $\overrightarrow{y'x'_i}$ . (See Figure 1.9.1). From the cos rule,

$$\cos \varphi = \frac{\|x'_i - y'\|}{2}$$

$$2 \cos \varphi = \|x'_i - y'\| < r'_k = \frac{2\alpha}{1 + \alpha}$$

$$\Rightarrow \cos \varphi < \frac{\alpha}{1 + \alpha}.$$

Furthermore, again from the cos rule and above statement

$$\cos \varphi = \frac{\|x_i - y\|/2}{1 + \alpha}$$

$$\|x_i - y\| = 2(1 + \alpha) \cos \varphi < 2(1 + \alpha) \frac{\alpha}{1 + \alpha}$$

$$\Rightarrow \|x_i - y\| < 2\alpha.$$

This means that  $y \in \text{int}(2\alpha\mathcal{B}^3 + x_i)$  since the difference between  $x_i \in \text{int}(2\alpha\mathcal{B}^3 + x_i)$  and  $y \in \partial((1 + \alpha)\mathcal{B}^3)$  is less than  $2\alpha$ .

$$\Rightarrow \forall y \in \partial((1 + \alpha)\mathcal{B}^3), \exists x_i \in \partial((1 + \alpha)\mathcal{B}^3) \text{ such that } y \in \text{int}(2\alpha\mathcal{B}^3 + x_i)$$

$$\Rightarrow \partial((1 + \alpha)\mathcal{B}^3) \subset \bigcup_{i=1}^k \text{int}(2\alpha\mathcal{B}^3 + x_i) \text{ when } \alpha = \frac{\sin \frac{r_k}{2}}{1 - \sin \frac{r_k}{2}} \text{ as calculated.}$$

So for given best covering by  $k$  equal circles of radius  $r_k$ , we calculate



$$\alpha = \frac{\sin\left(\frac{r_k}{2}\right)}{1 - \sin\left(\frac{r_k}{2}\right)} \quad \text{so that} \quad B_\alpha(\mathcal{B}^3) = k.$$

Also note that the density  $D_k$  of the covering is defined as the ratio of the total area of the surface of the spherical caps to the surface area of the sphere:

$$D_k = \frac{(1 - \cos r_k) k}{2}. \quad (1.64)$$

By these formulas, we get the following upper and lower boundaries for  $B_\alpha(\mathcal{B}^3) = k$  where  $k$  is stated for each case.

$$B_\alpha(\mathcal{B}^3) = 2 \Leftrightarrow 2.414\,213 < \alpha$$

where  $r_k = 90.000\,000$ ,  $D_k = 1.500\,000$ . For  $B_\alpha(\mathcal{B}^3) = 2$ , the best covering configuration is an antipodal pair and it is achieved by L. Fejes Tóth [9].

$$B_\alpha(\mathcal{B}^3) = 3 \Leftrightarrow 2.414\,213 < \alpha$$

where  $r_k = 90.000\,000$ ,  $D_k = 1.500\,000$ . For  $B_\alpha(\mathcal{B}^3) = 3$ , the best covering configuration is an equilateral triangle inscribed in a great circle which is not unique and achieved by L. Fejes Tóth [9].

$$B_\alpha(\mathcal{B}^3) = 4 \Leftrightarrow 1.366\,025 \leq \alpha \leq 2.414\,213$$

where  $r_k = 70.528\,779$ ,  $D_k = 1.333\,333$ . For  $B_\alpha(\mathcal{B}^3) = 4$ , the best covering configuration is the regular tetrahedron and achieved by L. Fejes Tóth [9].

$$B_\alpha(\mathcal{B}^3) = 5 \Leftrightarrow 1.108\,508 \leq \alpha \leq 1.366\,025$$

where  $r_k = 63.434949$ ,  $D_k = 1.381\,966$ . For  $B_\alpha(\mathcal{B}^3) = 5$ , the best covering configuration is the square pyramid which is not unique and achieved by Schütte [10].

$$B_\alpha(\mathcal{B}^3) = 6 \Leftrightarrow 0.850\,826 \leq \alpha \leq 1.108\,508$$

where  $r_k = 54.735610$ ,  $D_k = 1.267949$ . For  $B_\alpha(\mathcal{B}^3) = 6$ , the best covering configuration is an octahedron and achieved by L. Fejes Tóth [9].

$$B_\alpha(\mathcal{B}^3) = 7 \Leftrightarrow 0.756\,605 \leq \alpha \leq 0.850\,826$$

where  $r_k = 51.026553$ ,  $D_k = 1.298639$ . For  $B_\alpha(\mathcal{B}^3) = 7$ , the best covering configuration is the pentagon pyramid which is not unique and achieved by Schütte [10].

$$B_\alpha(\mathcal{B}^3) = 10 \Leftrightarrow 0.564\,637 \leq \alpha \leq 0.591\,091$$

where  $r_k = 42.307827$ ,  $D_k = 1.302304$ . For  $B_\alpha(\mathcal{B}^3) = 10$ , the best covering configuration is the bicapped square antiprism and achieved by Jucovič [11] and also by G. Fejes Tóth [12].

$$B_\alpha(\mathcal{B}^3) = 12 \Leftrightarrow 0.471\,509 \leq \alpha \leq 0.336\,995$$

where  $r_k = 37.377368$ ,  $D_k = 1.232073$ . For  $B_\alpha(\mathcal{B}^3) = 12$ , the best covering configuration is the icosahedron and achieved by Fejes Tóth [9].

$$B_\alpha(\mathcal{B}^3) = 14 \Leftrightarrow 0.428\,957 \leq \alpha \leq 0.444\,234$$

where  $r_k = 34.937927$ ,  $D_k = 1.302304$ . For  $B_\alpha(\mathcal{B}^3) = 14$ , the best covering configuration is the bicapped pentagon antiprism and achieved by G. Fejes Tóth [12].

The arrangements above are the best arrangements for given  $k$  since the density is a minimum. In cases where the solution is not known estimates can be given for the extremal density: lower bounds can be given, for example, by F. Toth's formula [14], but upper bounds can be most appropriately given by covering constructions.

In general it is not difficult to arrange  $k$  spherical caps so as to cover the surface of a sphere: most postulated patterns will obviously succeed if the caps are made sufficiently large. The problem is to maintain cover as the size of the caps is progressively reduced, and to adjust the layout progressively until no further improvement can be made. If we can reach this stage we have a locally extremal arrangement, which may or may not be a globally extremal arrangement, i.e., a solution to the covering problem. See T. Tarnai and ZS. Gáspár [19].

The conjectured solutions, which are not necessarily true optima, exist for some  $k$  as follows:

$$k = 8, 9, 11, 13, 15 - 20, 22, 26, 32, 38, 42, 50, 72, 122, 132. \quad (1.65)$$

We know that

$$\begin{aligned} \alpha &= \frac{\sin \frac{r_k}{2}}{1 - \sin \frac{r_k}{2}} \\ \Rightarrow r_k &= 2 \arcsin \left( \frac{\alpha}{1 + \alpha} \right). \end{aligned}$$

In 1955, K. Schütte [10] showed that

$$r_k \geq \arccos \left( \frac{1}{\sqrt{3}} \cot \left( \frac{k\pi}{6(k-2)} \right) \right).$$

Combining these two facts results in the following inequality:

$$r_k = 2 \arcsin \left( \frac{\alpha}{1 + \alpha} \right) \geq \arccos \left( \frac{1}{\sqrt{3}} \cot \left( \frac{k\pi}{6(k-2)} \right) \right)$$

$$\begin{aligned} \arcsin \left( \frac{\alpha}{1+\alpha} \right) &\geq \frac{1}{2} \arccos \left( \frac{1}{\sqrt{3}} \cot \left( \frac{k\pi}{6(k-2)} \right) \right) \\ \frac{\alpha}{1+\alpha} &\geq \sin \left( \frac{1}{2} \arccos \left( \frac{1}{\sqrt{3}} \cot \left( \frac{k\pi}{6(k-2)} \right) \right) \right) \end{aligned}$$

Then we have that

$$\begin{aligned} \alpha &\geq \sin \left( \frac{1}{2} \arccos \left( \frac{1}{\sqrt{3}} \cot \left( \frac{k\pi}{6(k-2)} \right) \right) \right) \\ &+ \alpha \sin \left( \frac{1}{2} \arccos \left( \frac{1}{\sqrt{3}} \cot \left( \frac{k\pi}{6(k-2)} \right) \right) \right) \\ \alpha &\geq \frac{\sin \left( \frac{1}{2} \arccos \left( \frac{1}{\sqrt{3}} \cot \left( \frac{k\pi}{6(k-2)} \right) \right) \right)}{1 - \sin \left( \frac{1}{2} \arccos \left( \frac{1}{\sqrt{3}} \cot \left( \frac{k\pi}{6(k-2)} \right) \right) \right)} \end{aligned} \quad (1.66)$$

where  $k \geq 4$ .

So for given  $k$ 's on (1.65), we have an upper bound for  $\alpha$  as calculated above. By using this formula, we can identify the lower and upper bounds of the smallest radius,  $\alpha$ , of these translates as follows:

$$B_\alpha(\mathcal{B}^3) = 8 \Leftrightarrow 0.652\,703 < \alpha < 0.756\,605$$

$$B_\alpha(\mathcal{B}^3) = 9 \Leftrightarrow 0.591\,091 < \alpha < 0.652\,703$$

$$B_\alpha(\mathcal{B}^3) = 11 \Leftrightarrow 0.336\,995 < \alpha < 0.564\,637$$

$$B_\alpha(\mathcal{B}^3) = 13 \Leftrightarrow 0.444\,234 < \alpha < 0.471\,509.$$

Similarly for  $B_\alpha(\mathcal{B}^3) = 15 - 20, 22, 26, 32, 38, 42, 50, 72, 122, 132$ , the upper bound of  $\alpha$  can be calculated. See the Table 2 in T. Tarnai and ZS. Gáspár [19] for calculated  $r_k$ ,  $D_k$  and references.

In 1991, T. Tarnai [16] has also emphasized that the structure of single-shelled rotavirus particles and the conjectured best covering for  $n = 132$  represent topologically identical configuration. This suggests that perhaps there might be a certain connection also between spherical viruses and the mathematical problem of covering of a ball by circles.

Some different occurrences of configurations, topologically identical to the proven and conjectured solutions of the covering problem enumerated in Table 2 (T. Tarnai and ZS. Gáspár [19]), are as follows:

1. Soap film cones with common apex :  $2 \leq k \leq 10$  and  $k = 12$ .
2. Bubbles in soap foam :  $11 \leq k \leq 15$ .
3. Boron hydrides :  $5 \leq k \leq 10$ ,  $12 \leq k \leq 19$ ,  $k=22$ ,  $32$ .
4. Complex alloy structures :  $k = 12, 14, 15, 16$ .
5. Hollow carbon clusters :  $k = 16, 18, 32, 122$ .
6. Coated vesicles :  $14 \leq k \leq 20$ ,  $k = 32$ .

For references, see T. Tarnai and ZS. Gáspár [19]. Furthermore; hex-pent clustered virus structures provide the proven or conjectured best solutions for  $k = 12, 32, 72, 122, 132$ . See T. Tarnai [16].  $\square$

## 1.8 The Blocking Number with Negative Copies

Let  $\mathcal{K}$  be a convex body in  $\mathbb{R}^n$ . The blocking number with negative translates of  $\mathcal{K}$  is the smallest number of non-overlapping negative translates of  $\mathcal{K}$  which are in contact with  $\mathcal{K}$  and prevent any other negative translates of  $\mathcal{K}$  from touching  $\mathcal{K}$  and we denote it by  $B_-(\mathcal{K})$ .

**Theorem 1.10** *Let  $\mathcal{K}$  be an  $n$ -dimensional convex body. Then*

$$n + 1 \leq B_-(\mathcal{K}).$$

**Proof of 1.10.**

Let  $\mathcal{K}$  be an  $n$ -dimensional convex body. In his well-known theorem, Borsuk proved that

*If  $\mathcal{K} \subset \mathbb{R}^n$  is covered by  $n + 1$  closed sets  $A_0, \dots, A_n$ , then  $\mathcal{K}$  can be carried onto a subset  $\mathcal{L}$  of  $\mathbb{R}^n$  by means of a continuous transformation  $f$  such that for each point  $\mathcal{Q}$  of  $\mathcal{L}$ , the set  $f^{-1}(\mathcal{Q})$  is entirely contained in one of the sets  $A_i$ .*

If this is rephrased, we have

$$\begin{aligned} f : \mathbb{R}^n &\mapsto \mathbb{R}^n \\ f : \mathcal{K} &\mapsto \mathcal{L} \\ A_i \supset f^{-1}(\mathcal{Q}) &\leftarrow \mathcal{Q}. \end{aligned} \tag{1.67}$$

Furthermore, Borsuk proved that

*For every continuous transformation of an  $n$ -sphere  $S^n$  onto a subset of  $\mathbb{R}^n$ , some pair of antipodal points in  $S^n$  must have the same image in  $\mathbb{R}^n$ .*

i.e.,

$$\begin{aligned} f : S^n &\mapsto \mathcal{K} \subset \mathbb{R}^n \\ \exists A, -A \in S^n &\mapsto f(A) = f(-A) \in \mathbb{R}^n. \end{aligned} \tag{1.68}$$

where  $A$  and  $-A$  are a pair of antipodal points of  $S^n$ .

One can deduce the following “Borsuk-Ulam Theorem” from two above theorems:

*Whenever  $S^n$  is covered by  $n + 1$  closed sets  $F_0, \dots, F_n$ , at least one of the sets includes 2 antipodal points.*

Now we will show that  $n + 1 \leq B_-(\mathcal{K})$ . In order to prove this, we suppose that one can block  $\mathcal{K}$  with  $n$  negative translates of  $\mathcal{K}$ , i.e.,  $B_-(\mathcal{K}) < n$ .

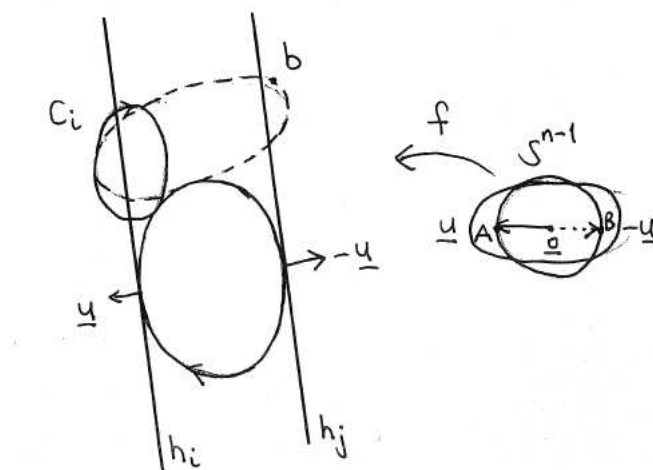

Figure 1.10.1

Let  $\mathfrak{U} := \{\mathcal{K}_1, \mathcal{K}_2, \dots, \mathcal{K}_n\}$  be the blocking set for  $\mathcal{K}$  where  $\mathcal{K}_i$ 's are the negative translates of  $\mathcal{K}$ . The negative translates,  $\mathcal{K}_i$ 's, will be reduced slightly so that they have radius  $-\lambda$ , but they still block  $\mathcal{K}$ . We denote the new reduced copies  $\mathcal{C}_1, \dots, \mathcal{C}_n$ , i.e.,  $\mathcal{C}_i := -\lambda\mathcal{K}_i$ .

Let  $\underline{u} \in S^{n-1}$  and  $H(\underline{u})$  be the corresponding supporting hyperplane to  $\mathcal{K}$  with outward normal  $\underline{u}$ . (See Figure 1.10.1). Then  $H(\underline{u})$  meets at least one of  $\mathcal{C}_1, \dots, \mathcal{C}_n$ . We put

$\underline{u}$  into  $F_i$  if  $H(\underline{u})$  meets  $C_i$ . Then  $F_1, \dots, F_n$  are closed sets whose union covers  $S^{n-1}$ . By Borsuk-Ulam, there exists  $\underline{u}, -\underline{u} \in F_i$  for some  $i$ . This gives a contradiction to our assumption since  $C_i$  is a shrunk negative copy of  $\mathcal{K}$  and so can not meet both  $H(\underline{u})$  and  $H(-\underline{u})$ .

So our assumption gives a contradiction that  $n$  translates can not be enough to block  $\mathcal{K}$ , i.e., at least  $n + 1$  translates are necessary. We conclude

$$n + 1 \leq B_-(\mathcal{K})$$

as required.  $\square$

As the lower bound for  $B_-(\cdot)$  is established, we conjecture that the upper bound is  $2^n$ :

**Conjecture 1.8.1** *Let  $\mathcal{K}$  be an  $n$ -dimensional convex body.*

$$B_-(\mathcal{K}) \leq 2^n$$

The next theorem proves that this conjecture is true in 2-dimensional case:

**Theorem 1.11** *Let  $\mathcal{K}$  be a convex domain. Then*

$$3 \leq B_-(\mathcal{K}) \leq 4$$

**Proof of 1.11.**

From Theorem 1.10, we have  $3 \leq B_-(\mathcal{K})$ .

Now we will prove that  $B_-(\mathcal{K}) \leq 4$ . In order to prove this, first we need to introduce the following two lemmas:



**Lemma 1.8.1** *Let  $\mathcal{K}$  be a convex body in  $\mathbb{R}^n$  and suppose  $-\mathcal{K} + \underline{x}_0$  touches  $\mathcal{K}$ . Then  $\underline{x}_0 \in \partial(2\mathcal{K})$ .*

**Proof of 1.8.1.** If  $-\mathcal{K} + \underline{x}_0$  touches  $\mathcal{K}$  at  $\underline{y}$  then  $\underline{y} = -k + \underline{x}_0$  for some  $k \in \mathcal{K}$ . So we have

$$\underline{y} + k = \underline{x}_0, \text{ i.e., } \underline{x}_0 \in 2\mathcal{K}. \quad (1.69)$$

Now let the hyperplane  $\langle x, u \rangle = \langle y, u \rangle$  separate  $\mathcal{K}$  from  $-\mathcal{K} + \underline{x}_0$ , i.e.,

$$\begin{aligned} \langle k, u \rangle &\leq \langle y, u \rangle \leq \langle -k + \underline{x}_0, u \rangle \text{ for each } k \in \mathcal{K} \\ \text{So } \langle 2k, u \rangle &\leq \langle \underline{x}_0, u \rangle \text{ for each } k \in \mathcal{K}. \end{aligned} \quad (1.70)$$

Consequently, combining 1.69 and 1.70, we have  $\underline{x}_0 \in \partial(2\mathcal{K})$ .  $\square$

**Lemma 1.8.2** *If  $\mathcal{K}$  is a convex body in  $\mathbb{R}^n$ , the sets  $\{-\mathcal{K} + x_i\}_{i=1}^m$  block  $\mathcal{K}$ ,  $x_i \in \partial(2\mathcal{K})$ ,  $i = 1, \dots, m$  if and only if the sets  $\{\text{int } D\mathcal{K} + \underline{x}_i\}_{i=1}^m$  cover  $\partial(2\mathcal{K})$ .*

**Proof of 1.8.2.** If  $\{-\mathcal{K} + \underline{x}_i\}_{i=1}^m$  block  $\mathcal{K}$  and  $-\mathcal{K} + y$  touches  $\mathcal{K}$  then, by lemma 1.8.1,  $y \in \partial(2\mathcal{K})$  and there exists  $i$  such that  $\text{int } (-\mathcal{K} + x_i) \cap \text{int } (-\mathcal{K} + y) \neq \emptyset$ , i.e., there exists  $k_1, k_2 \in \text{int } \mathcal{K}$  with  $-k_1 + x_i = -k_2 + y$ , i.e.,  $k_2 - k_1 + x_i = y$  where  $k_1 - k_2 \in \text{int } D\mathcal{K}$ . So  $\{\text{int } D\mathcal{K} + \underline{x}_i\}_{i=1}^m$  cover  $\partial(2\mathcal{K})$ .

Conversely, if  $\{\text{int } D\mathcal{K} + \underline{x}_i\}_{i=1}^m$  covers  $\partial(2\mathcal{K})$ , let  $-\mathcal{K} + y$  touch  $\mathcal{K}$ . Then, by lemma 1.8.1,  $y \in \partial(2\mathcal{K})$  and  $y \in \text{int } D\mathcal{K} + \underline{x}_i$  for some  $i$ .

Therefore we have  $\text{int } (-\mathcal{K} + x_i) \cap \text{int } (-\mathcal{K} + y) \neq \emptyset$  and the translates  $\{-\mathcal{K} + x_i\}_{i=1}^m$  block  $\mathcal{K}$ .  $\square$

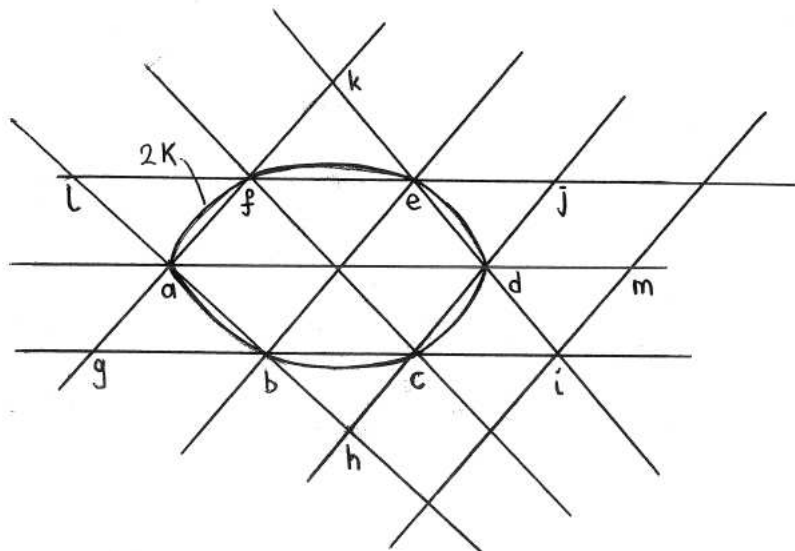

Figure 1.11.1

So in order to prove  $B_-(\mathcal{K}) \leq 4$ , it is sufficient to prove that  $\partial(2\mathcal{K})$  can be covered by four sets,  $\{DK + x_i\}_{i=1}^4$ , where  $x_i \in \partial(2\mathcal{K})$ . Now using these two lemmas we will prove this statement as follows:

It is known that every convex body  $2\mathcal{K}$  has an inscribed affinely regular hexagon  $\mathcal{H}$ . We suppose that  $\mathcal{H}$  is regular and  $\mathcal{H}$  has centre  $\underline{O}$ . Then we have  $\mathcal{H} = -\mathcal{H} \subset DK$ . Let  $\mathcal{H}$  have vertices  $a, b, c, d, e, f$  as can be seen in figure 1.11.1.

Then  $\partial(2\mathcal{K})$  is covered by three translates  $\mathcal{H} + d$ ,  $\mathcal{H} + f$ , and  $\mathcal{H} + b$ ; hence  $\partial(2\mathcal{K})$  is also covered by  $DK + d$ ,  $DK + f$  and  $DK + b$ . Note that three points  $a, c$  and  $e$ , of  $\partial(2\mathcal{K})$  may not be in  $\text{int } DK + d$ ,  $\text{int } DK + f$  and  $\text{int } DK + b$ . So we push  $DK + d$ ,  $DK + f$  and  $DK + b$  slightly to cover  $e$  and  $c$ . Then we need add a fourth translate to cover the vertex  $a$ . Hence, we have four translates  $\{DK + x_i\}_{i=1}^4$  to cover  $\partial(2\mathcal{K})$ .  $\square$

Here we should emphasize that for the lower and upper bounds of negative blocking number in 2–dimension,  $3 \leq B_-(\mathcal{K}) \leq 4$ , we have the following examples:

$$B_-(\mathcal{K}) = 3 \text{ if } \mathcal{K} \text{ is a triangle}$$

$$B_-(\mathcal{K}) = 4 \text{ if } \mathcal{K} \text{ is a square.}$$

Since we already established the lower bound,  $n + 1$ , we have the following conjecture for the blocking number with negative copies:

**Conjecture 1.8.2** *The upper bound for the negative blocking number of any  $n$ –dimensional convex body,  $\mathcal{K}$ , is*

$$B_-(\mathcal{K}) \leq 2^n.$$

# Bibliography

- [1] C. M. Zong : *A Problem of Blocking Light Rays*. Geometriae Dedicata; 67 (1997) 117-128
- [2] K. Böröczky Jr., D. G. Larman, S. Sezgin and C. M. Zong : *On Generalized Kissing Numbers and Blocking Numbers*. Rendiconti Del Circolo Matematico Di Palermo; Serie II, Suppl. 65 (2000) 39-57
- [3] C. M. Zong : *Some Remarks Concerning Kissing Number, Blocking number and covering numbers*. Period. Math. Hungar.; 30 (1995) 233-238
- [4] L. Dalla, D. G. Larman, P. Mani-Levitska and C. M. Zong : *The Blocking Numbers of Convex Bodies*. Discrete Comput. Geom.; 24 (2000) 267-277
- [5] T. Bonnesen, and W. Fenchel, *Theorie der Konvexen Körper*. N Y, (1948), 130-135
- [6] C. M. Zong : *Strange Phenomena in Convex and Discrete Geometry*. Springer-Verlag New York; (1996)
- [7] L. Fejes Tóth : *Über eine affininvariante Masszahl bei Eipolyedern*. Studia Sci. Math. Hung.; 5 (1970) 173-180
- [8] C. A. Rogers : *Covering a Sphere with Spheres*. Mathematika; 10 (1963), 157-164

- [9] L. Fejes Tóth : *On Covering a Spherical Surface with Equal Spherical Caps (in Hungarian)*. Matematikai Fiz. Lapok; 50 (1943) 40-46
- [10] K. Schütte : *Überdeckung der Kugel mit höchstens acht Kreisen*. Math. Annln; 129 (1955) 181-186
- [11] E. Jucovič : *Some Coverings of a Spherical Surface with Equal Circles (in Slovakian)*. Mat.-Fyz. Časopis. Slovensk. Akad. Vied.; 10 (1960) 99-104
- [12] G. Fejes Tóth : *Kreisüberdeckungen der Sphäre*. Studia Sci. Math. Hungar.; 4 (1969) 225-247
- [13] P. M. L. Tammes : *On the Origin of Number and Arrangement of the Places of Exit on the Surface of Pollen-grains*. Recueil des travaux botaniques néerlandais; 27 (1930) 1-84
- [14] L. Fejes Tóth : *Lagerungen in der Ebene auf der Kugel und im Raum, 2nd edition*. Berlin, Springer-Verlag 1972
- [15] H. T. Croft, K. J. Falconer and R. K. Guy : *Unsolved Problems in Geometry*. New York, Springer-Verlag 1991
- [16] T. Tarnai : *The Observed Form of Coated Vesicles and a Mathematical Covering Problem*. J. Molec. Biol.; 218 (1991) 485-488
- [17] P. W. Fowler and T. Tarnai : *Transition from Spherical Circle Packing to Covering: Geometrical Analogues of Chemical Isomerization*. Proc. R. Soc. Lond. A; 452 (1996) 2043-2064
- [18] H. Meschkowski : *Ungelöste und unlösbare Probleme der Geometrie*. Braunschweig, 1960
- [19] T. Tarnai and ZS. Gáspár : *Covering a Sphere by Equal Circles, and the Rigidity of its Graph*. Math. Proc. Camb. Phil. Soc.; 110 (1991) 71-89