

ALGEBRAIC FOUNDATIONS FOR QUALITATIVE CALCULI AND NETWORKS

ROBIN HIRSCH, MARCEL JACKSON, AND TOMASZ KOWALSKI

ABSTRACT. Binary Constraint Problems have traditionally been considered as Network Satisfaction Problems over some relation algebra. A constraint network is satisfiable if its nodes can be mapped into some representation of the relation algebra in such a way that the constraints are preserved. A qualitative representation ϕ is like an ordinary representation, but instead of requiring that $(a;b)^\phi$ is the composition $a^\phi \circ b^\phi$ of the relations a^ϕ and b^ϕ , as we do for ordinary representations, we only require that $c^\phi \supseteq a^\phi \circ b^\phi \iff c \geq a;b$, for each c in the algebra. A constraint network is qualitatively satisfiable if its nodes can be mapped to elements of a qualitative representation, preserving the constraints. If a constraint network is satisfiable then it is clearly qualitatively satisfiable, but the converse can fail, as we show. However, for a wide range of relation algebras including the point algebra, the Allen Interval Algebra, RCC8 and many others, a network is satisfiable if and only if it is qualitatively satisfiable.

Unlike ordinary composition, the weak composition arising from qualitative representations need not be associative, so we can generalise by considering network satisfaction problems over non-associative algebras. We prove that computationally, qualitative representations have many advantages over ordinary representations: whereas many finite relation algebras have only infinite representations, every finite qualitatively representable algebra has a finite qualitative representation; the representability problem for (the atom structures of) finite non-associative algebras is **NP-complete**; the network satisfaction problem over a finite qualitatively representable algebra is always in **NP**; the validity of equations over qualitative representations is **co-NP-complete**. On the other hand we prove that there is no finite axiomatisation of the class of qualitatively representable algebras.

1. INTRODUCTION

Computer scientists have been solving systems of binary constraints for a long time. Temporal reasoning, for example, is often dealt with by solving a set of temporal constraints between events, represented in a *network*: a finite complete graph whose edges are labelled by a choice of alternative temporal relations. The network is *satisfiable* if it is possible to map the nodes to temporal events in such a way that each pair of nodes is mapped to a pair of events satisfying one of the alternative temporal relations labelling that edge. An algebra of these relations, in one of the simplest cases, is the *point algebra*, where the primitive alternative relations are $=, <, >$ and the events are points on a linear flow of time. Relational compositions of these basic relations are recorded in the table in the upper left corner of Figure 1, where \circ denotes composition of binary relations.

The second author was supported by ARC Future Fellowship FT120100666 and Discovery Project DP1094578. The third author was supported by ARC Future Fellowship FT100100952.

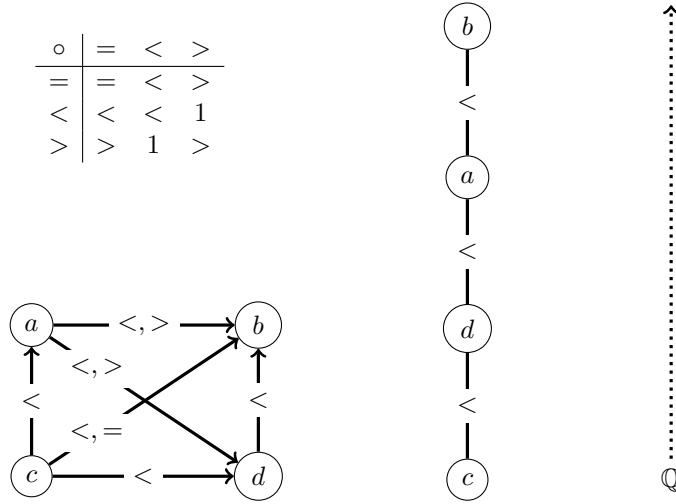

FIGURE 1. The point algebra: composition table, a constraint network, a solution, a strong representation. Here 1 denotes $\{=, <, >\}$ (all three relations are permitted).

Consider the network over the point algebra given in Figure 1. It is satisfiable in a linear order of just four distinct points, but a *representation* of the point algebra has to be infinite, because $< \circ <$ is identical to $<$, which entails not just transitivity ($< \circ <$ is contained in $<$) but also density ($<$ is contained in $< \circ <$). This discrepancy between an infinitely *representable* algebra and finitely *satisfiable* networks over it, is not too serious in this case because every finite linear order embeds into the rational numbers. Hence, if a network has a solution in some linear order then it can be embedded into a representation of the point algebra.

To deal with temporal intervals rather than point-events, the Allen Interval Algebra [All83] is very commonly used. Here, we have thirteen alternative primitive relations between intervals on a linear flow of time. For the Allen Interval Algebra, a solution to a constraint network would be a finite set of intervals in a linear order with an appropriate relation holding between each pair, but a representation of this algebra is again infinite: it consists of ordered pairs taken from a dense linear order without endpoints [LM94]. And again, there is no real discrepancy here because every finite arrangement of intervals in a linear order embeds into a set of intervals of rational numbers.

But when one tries to generalise the above examples to apply relational reasoning in other domains, the discrepancy becomes a real issue. A very clear example of this occurs in *spatial reasoning*, where an analogue of the Allen Interval Algebra with relations between spatial regions is used. This algebra is called RCC8. One of the basic relations considered in RCC8 is *external connectedness* (EC), whose intended interpretation is that $xECy$ if regions x and y touch at the borders but only at the borders, for example as in the left-hand side of Figure 2. Now, RCC8 requires that $EC \circ EC \supseteq EC$, which is reasonable if we think of regions topologically as open balls (open disks in \mathbb{R}^2 ; more generally, open sets with boundaries of genus 0), because then for any $xECy$ we can find a z with $xECzECy$, as in the left-hand side of Figure 2. However, in real-life applications, this assumption is not

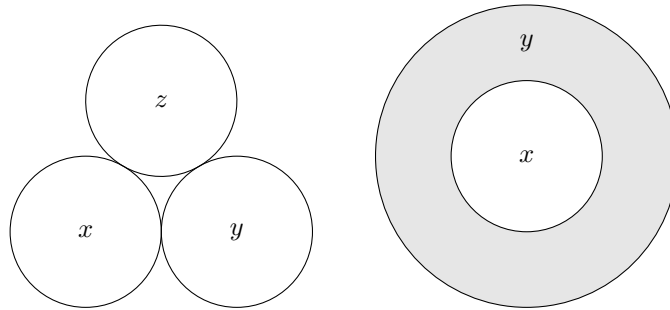

FIGURE 2. Some relations between spatial regions

always warranted. For it happens that one region can be completely surrounded by another. This is the spatial relation San Marino bears to Italy, the Vatican City to Rome, and Lesotho to South Africa. When this happens, as in the right-hand side of Figure 2, where region y is the annulus surrounding region x , we have $xECy$, but $(x, y) \notin EC \circ EC$.

The problem was identified, and rightly diagnosed to be an anomaly. The remedy was to consider an algebra of binary relations where relational composition is replaced by another binary operation, called *weak composition*, approximating real composition from above (see, for example [LR04]). Weak composition is defined in such a way that when (x, y) is in the weak composition of EC with EC it is not *mandatory* that there is a z with $xECzECy$, it is merely *permitted* that such a z should exist. (Note, below we distinguish two different meanings of weak composition from the literature: either it is merely permitted that such a z should exist, or it is permitted and additionally there must be x', y', z' such that $x'ECz'ECy'$ i.e. the composition has to be realised at least once. The two corresponding types of representations we consider are *feeble* and *qualitative* respectively, see below.) Since then, an impressive body of research has been conducted in qualitative reasoning based on these notions of weak composition (see [CCL⁺15] for a survey).

REMARK 1. *Another way of dealing with the annulus problem would be to restrict the allowed shape of spatial regions. For example, allowing only open balls in \mathbb{R}^2 as regions gives an interpretation of RCC8 with the usual relational composition. However, there exist practically motivated qualitative calculi for which no interpretation using standard relational composition is possible: such is for example the interval and duration calculus INDU, whose twenty-five primitive relations are similar to Allen's thirteen primitive interval relations, but also determine whether the duration of the first interval is smaller, equal or greater in duration than the second interval [PKS99]. The composition operation in INDU is not associative.*

One restriction to this framework of qualitative reasoning is that the identity relation is assumed to be an indivisible primitive relation (an *atom* of the algebra), so that unary properties of states cannot be expressed directly. So, for example, suppose we want to assert that a certain time interval occurs *during* an interval where the printer is working. In the Allen Interval Algebra we can express that one interval i occurs *during* another interval j but we cannot assert properties of the interval j . In our framework we may introduce a subidentity atom w with intended semantics jw if and only if the printer is working on the interval j . A similar

extension was required for *Kleene Algebra*, where it was necessary to introduce the *test* operator in order to express properties of states, rather than relations [Koz97]. Here, we make no assumption that the identity is atomic.

A further restriction is that the definition of weak composition only applies in the setting of finitely many primitive relations. However, there are applications in Artificial Intelligence where infinitely many different relations are needed. A number of different researchers who wished to add quantitative reasoning to qualitative constraint systems, adopted languages containing infinitely many constraints (e.g. [KL91, Mei96, Hir96] or see [OW08] for a survey of metric temporal logic, also see Example 7.8 below). In the study of topological relations between convex plane regions [LL:10] infinitely many binary constraints are needed.

In this article we define the weak composition of two binary relations in general; our definition coincides with the original one where it applies, but covers a wider range of algebras of binary relations. We also define a corresponding notion of qualitative representation. In a classical representation of a relation algebra (referred to henceforth as a *strong representation*), given two points x, y for which it is *consistent* for there to be a z with $(x, z) \in a$, $(z, y) \in b$ it is then *mandatory* that such a point z exists. This requirement is relaxed in a qualitative representation, see Definition 3 below. A constraint network is qualitatively satisfiable if it embeds into a qualitative representation. We will see that this corresponds much more closely to the intuitive approach to binary constraint problems, such as those illustrated in Figure 1. There, the four element chain is in fact a qualitative representation of the point algebra.

1.1. Fixed vs. arbitrary representations. When considering the constraint satisfaction problem in its general setting one typically has a fixed domain for each variable and the interpretation of any relation symbols used in the constraints is also fixed. In keeping with that, a great deal of the research into qualitative reasoning focusses on a fixed set of relations on a fixed base set and considers the satisfiability of constraints in that setting, in other words the issue is the satisfiability of constraints in a single, fixed representation. To illustrate the value of this approach, suppose we wish to schedule a series of meetings in a discrete flow of time where there are exactly four time points, as in Figure 1. A set of binary constraints on the scheduling of events could be represented as a network over the point algebra, but the question to consider is not whether the network is satisfiable in *some* qualitative representation, it is whether the network can be satisfied in the qualitative representation of the point algebra consisting of a linear order of four points. For this kind of problem it is the satisfiability of a network in a fixed representation that should be considered. (The complexity of this problem can be fairly high, for example in [Lee14] a single model based on *dipoles* in the real plane, (i.e. elements of \mathbb{R}^4) is adopted and it is shown that the network satisfaction problem is $\exists\mathbb{R}$ -complete for various algebras of relative directional constraints over this model. For a more extreme case, consider a graph algebra with three primitive constraints: equals, adjacent and non-adjacent. Let S be an undecidable set of finite connected graphs and let G be the disjoint union of all graphs in S . Given any finite connected graph F we can define a network on the same set of nodes, edges are labelled ‘adjacent’ and irreflexive non-edges are labelled ‘non-adjacent’. Since this network is qualitatively satisfiable in G if and only if $F \in S$, the problem of determining whether a network is satisfiable in G is undecidable.)

However, there are applications where the representation is not fixed, for example in spatial reasoning using RCC8 the exact topography of the relations between regions may not be known. Many of the theorems proved in the previously cited papers establish properties that hold over a whole class of representations, e.g. results in [Ren02] refer to the solvability of RCC8 constraints over non-empty, regular, closed regions, regardless of the particular topology under consideration. The main decision problem considered in the current paper is to decide if a given network is satisfiable in an arbitrary qualitative representation.

Results obtained in this paper indicate that qualitative representations have computational advantages over strong representations. All the algebras of relations mentioned above have strong representations, but only on infinite base sets. In contrast, we show that if a finite algebra of relations (formally, a non-associative algebra) has a qualitative representation then it has one on a finite base set. A consequence is that the problem of determining whether a finite non-associative algebra is qualitatively representable is in **NP** (indeed it is **NP-complete**) whereas the strong representation problem is known to be undecidable [HH01b].

Furthermore, although it happens to be the case that a consistent, atomic network of constraints (a consistent network with only a single primitive relation on each edge) is always satisfiable for the algebras of relations previously mentioned, and hence a polynomial time, non-deterministic algorithm can solve the network satisfaction problem for these algebras by guessing a primitive label for each edge and then checking their consistency, this does not work for other algebras of spatial relations. For example, there are known, consistent, atomic networks over the algebra INDU, which cannot be satisfied by intervals [Lig11, Figure 8.11]. Thus consistency of a network does not suffice to prove that the network is satisfiable, even if the network is atomic. Although the network satisfaction problem remains in **NP** for INDU-networks, there are known relation algebras where the problem has much worse complexity [Hir99]. On the other hand, for any finite algebra of relations the network satisfaction problem over qualitative representations always belongs to **NP**.

Similarly, although the validity of equations valid over strong representations was shown to be undecidable by Tarski, the validity of equations valid over all qualitative representations is decidable (indeed it is **co-NP-complete**). Our conclusion is that qualitative representations are not only more appropriate to express the kind of constraints that arise from many applications, but they are more amenable to algorithmic reasoning.

1.2. Historical remarks. The structures we called algebras above, were conceived as *calculi*: formal rules for manipulating relations, invented and developed *ad hoc*, to suit the purpose at hand. This is evident in the naming: for example, RCC8 is so called because it was originally developed in [RCC92] as *Region Connection Calculus*, with 8 basic relations, hence the acronym RCC8 (although the names of the three authors might also have something to do with it). Later, mathematicians observed that such calculi, including the point algebra, Allen Interval Algebra and RCC8, were examples of Tarski's Relation Algebras. As far as we know, this observation was first made in [LM88, LM94]. In this setting, the basic relations are boolean atoms in a relation algebra, the edges of a network are labelled by arbitrary elements of the relation algebra and the network is satisfiable if its nodes can be mapped into some representation of the relation algebra

in such a way that the label of an edge of the network holds at the corresponding two points in the representation. However, as we outlined above, there were difficulties in restricting to strong representations, particularly for relation algebras such as RCC8, and this led to the weaker notion of qualitative representation, now very widely studied in knowledge representation and its applications, see [DWM01, LR04, LW06, MSW06, CCL⁺15, RL05], for example.

1.3. Notation. We deal with abstract algebras and concrete representations as binary relations and separate the notation, to some extent. Working abstractly we use $+$, $-$ as the basic boolean operators and introduce standard abbreviations, such as $x \cdot y = -(-x + -y)$ and $x \leq y \leftrightarrow x + y = y$. The identity constant is $1'$, the converse operator is \checkmark and any algebraic multiplication-like operator (including weak composition, below) will be denoted by $;$. Working with concrete binary relations we write \cup, \setminus for the operators corresponding to $+$, $-$ and we write $\text{Id}_D = \{(x, x) : x \in D\}$ for the identity relation over a domain D , corresponding to the abstract $1'$, though we may drop the subscript D if it is clear from the context. The converse of a binary relation r will be written as $r^\checkmark = \{(y, x) : (x, y) \in r\}$. We write $r \circ s = \{(x, y) \in D \times D : \exists z \in D (x, z) \in r \wedge (z, y) \in s\}$ for the composition of two binary relations r, s . Our convention is that converse has highest precedence, followed by composition which takes precedence over other operators, for example $a \cdot b ; c^\checkmark$ denotes $a \cdot (b ; (c^\checkmark))$. For any set S we write $\mathcal{P}(S)$ for the power set of S .

2. BACKGROUND

A *qualitative calculus* has traditionally been defined (see, for example, [LR04]) by specifying a finite partition $\Pi = (R_0, \dots, R_n)$ of the set $D \times D$, for some fixed (usually infinite) domain D , with the following properties:

- (1) The identity relation Id_D is an element of the partition,
- (2) Π is closed under relational converses, that is, $R^\checkmark \in \Pi$ for every $R \in \Pi$.

The set $\{R_0, \dots, R_n\}$ generates a boolean subalgebra \mathcal{B} of $\mathcal{P}(D \times D)$ under the usual set-theoretical operations. Clearly, R_0, \dots, R_n are atoms of \mathcal{B} ; these include the identity relation. Moreover, \mathcal{B} is closed under relational converses. However, \mathcal{B} is not in general closed under relational composition, as the example of Figure 2 indicates. This is remedied by considering *weak composition* instead: an operation defined by

$$S ; T = \bigcup \{R \in \Pi : R \cap (S \circ T) \neq \emptyset\}$$

where $S \circ T$ stands for the true composition of S and T . So defined, $S ; T$ is the smallest element of \mathcal{B} containing $S \circ T$.

Thus, a qualitative calculus carries a natural algebraic structure of the type of a relation algebra. Viewed from an abstract algebraic perspective, a qualitative calculus is a hybrid object: an abstract algebra together with a concrete interpretation, or a *representation*. As in [WHW14], one of our aims in this article is to separate the two sides of a qualitative calculus, into *syntax* (algebra) and *semantics* (representation), and so investigate the foundations of qualitative calculi in a manner similar to model theoretical analysis of classical mathematics.

Before we state the basic definitions, let us recall the two generalisations that we adopt from the outset. Firstly, we will lift the finiteness assumption. It is not necessary for a definition of weak composition, and from a universal algebraic point of view admitting infinite algebras is more natural, furthermore, as we have seen,

there are applications where it is desirable to include infinite relation algebras, for example when we wish to express *metric constraints*. Secondly, we do not require that the identity is an atom, as subidentity relations provide a natural way of modelling *properties*, that is, subsets of the domain, by representing a set $Z \subseteq D$ by the relation $\{(z, z) : z \in Z\}$.

DEFINITION 2. *Let D be a set and let \mathcal{S} be a set of binary relations over D , that is, $\mathcal{S} \subseteq \mathcal{P}(D \times D)$. \mathcal{S} is a herd if*

- (1) \mathcal{S} forms a boolean set algebra with top element $D \times D$, so \mathcal{S} is closed under finite intersections and complement relative to $D \times D$,
- (2) $\text{Id}_D \in \mathcal{S}$,
- (3) If $A \in \mathcal{S}$ then the converse relation A^\smile is in \mathcal{S} .

In a herd \mathcal{S} given any two elements $A, B \in \mathcal{S}$ if there is a minimal $C \in \mathcal{S}$ containing $A \circ B$ then we say that the *weak composition* of A and B is C . If \mathcal{S} is finite, then such a minimal element is sure to exist, since \mathcal{S} is closed under finite intersections.

For herds with infinitely many relations, the weak composition of two elements is not always defined (a minimal element containing $A \circ B$ may not exist), however the case we are interested in is the case where the weak composition of A and B is defined, and for the abstract algebraic structure corresponding to herds we include a binary composition operator $;$, so the signature is the same as that of a relation algebra: it is a boolean algebra with an extra nullary operation $1'$ for identity, a unary operation $^\smile$ for converse, and a binary operation $;$ to denote weak composition and it obeys all the axioms defining a relation algebra except perhaps associativity (see below). Maddux calls such an algebra a *non-associative relation algebra* [Mad82, Definition 1.2], or non-associative algebra for short. [LR04] already observed that their qualitative calculi are non-associative algebras and it is easily verified that the herds considered here are non-associative algebras too, in the cases where weak composition is defined.

An algebra $\mathcal{A} = (A, 0, 1, +, -, 1', ^\smile, ;)$ of the type of relation algebras belongs to the variety **NA** of *non-associative algebras*, if

- (1) $(A, 0, 1, +, -)$ is a boolean algebra,
- (2) $(A, 1', ^\smile, ;)$ is an involuted monoid, i.e. it satisfies
 - (a) $1' ; x = x = x ; 1'$
 - (b) $x^{\smile\smile} = x$
 - (c) $(x ; y)^\smile = y^\smile ; x^\smile$
- (3) $^\smile$ and $;$ are normal additive operators, that is
 - (a) $0^\smile = x ; 0 = 0$,
 - (b) $(x + y)^\smile = x^\smile + y^\smile$, $x ; (y + z) = (x ; y) + (x ; z)$
- (4) $x ; y \cdot z^\smile = 0$ if and only if $y ; z \cdot x^\smile = 0$ (Peircean law)

By additivity, the operators are monotone, e.g. $y \leq z \rightarrow x ; y \leq x ; z$, etc. Since the operators $^\smile, ;$ are *conjugated* it turns out that every non-associative algebra is *completely additive*, i.e. if S is a subset of the elements of \mathcal{A} with a supremum ΣS then $(\Sigma S)^\smile$ is the supremum of $\{s^\smile : s \in S\}$ and for any $a \in \mathcal{A}$ the element $a ; \Sigma S$ is the supremum of $\{a ; s : s \in S\}$ [JT51, Theorem 1.14].

In the following we define a qualitative representation as an *isomorphism* from an non-associative algebra to a herd. In [LR04, Definition 3] the corresponding definition is only required to be a homomorphism, injectivity is not required. One

difficulty with this weaker notion of representation is that trivial map from an arbitrary non-associative algebra to the herd on an empty domain is a non-injective homomorphism, which suggests that it is more natural to require injectivity.

DEFINITION 3. *Let $\mathcal{A} = (A, 0, 1, +, -, 1', \smile, ;)$ be a non-associative algebra. A qualitative representation ϕ of an algebra \mathcal{A} is an injection to a herd \mathcal{S} of binary relations over base D , such that*

- (1) $0^\phi = \emptyset$, $1^\phi = D \times D$, $(1')^\phi = \text{Id}_D$,
- (2) $(a + b)^\phi = a^\phi \cup b^\phi$, $(-a)^\phi = (D \times D) \setminus a^\phi$,
- (3) $(a^\smile)^\phi = (a^\phi)^\smile$,
- (4) $c^\phi \supseteq a^\phi \circ b^\phi \leftrightarrow c \geq a ; b$

for all $a, b, c \in A$. If \mathcal{A} has a qualitative representation, then we say that \mathcal{A} is a qualitatively representable algebra. The class of all qualitatively representable algebras we will denote by QRA.

If $(a ; b)^\phi = a^\phi \circ b^\phi$ for all $a, b \in \mathcal{A}$ then the qualitative representation ϕ is a strong representation.

If ϕ is a qualitative representation of a non-associative algebra \mathcal{A} , observe that $a ; b$ is always defined (for $a, b \in \mathcal{A}$) and Definition 3.4 requires that it is the minimal solution of $c \in \mathcal{A}$, $c^\phi \supseteq a^\phi \circ b^\phi$.

The class of strongly representable relation algebras, which generates the variety RRA of *representable relation algebras*, is already known to be extremely complicated: without finite axiomatisation in first order logic, with undecidable equational theory and with undecidable membership problem for finite algebras [HH01b]. The class QRA is known to be a proper subclass of NA [LR04, WHW14], or see Example 7.4 below. We show below that the class QRA has intermediate difficulty: it is also without a finite axiomatisation (Theorem 20) but it is **NP-complete** to decide membership for finite algebras (Theorem 15).

The definition of qualitative representation (Definition 3) is based on the definition of weak composition for partition schemes given in [LR04, §2.3], however our definition applies not just to finite partition schemes, it works even for infinite herds. Moreover, Ligozat and Renz appear to include two distinct notions of weak composition. In [RL05, abstract] they require that weak composition is “the strongest relation containing the real composition”, in agreement with much of the relevant literature and in agreement with Definition 3 above. However, in [LR04, Definition 3] and in [Lig05, Definition 2] only the right to left implication of Definition 3(4) is required, that is, they only require $(a ; b)^\phi \supseteq a^\phi \circ b^\phi$ and do not insist that $c = a ; b$ is the minimal solution of $c^\phi \supseteq a^\phi \circ b^\phi$ as c ranges over elements of the algebra. We call this looser definition of a qualitative representation a *feeble* representation and investigate it separately in Section 6. Example 7.1 and 7.4 below show that there is a real discrepancy between qualitative representations and feeble representations. ([WHW14, Proposition 2] dispute a quite separate point in [RL05], concerning the notion of “closure under constraints”.)

LEMMA 4. *Let $\phi : \mathcal{A} \rightarrow \mathcal{P}(D \times D)$ respect the boolean operators, the identity and the converse operator, i.e. $1^\phi = D \times D$, $(-a)^\phi = (D \times D) \setminus a^\phi$, $(a + b)^\phi = a^\phi \cup b^\phi$, $(1')^\phi = \text{Id}_D$ and $(a^\smile)^\phi = \{(y, x) : (x, y) \in a^\phi\}$. The following are equivalent*

- (1) ϕ is a qualitative representation
- (2) for all $a, b, c \in \mathcal{A}$

$$(a ; b \cdot c \neq 0) \leftrightarrow \exists x, y, z \in D((x, y) \in a^\phi \wedge (y, z) \in b^\phi \wedge (x, z) \in c^\phi).$$

Proof. For (1) \Rightarrow (2), suppose ϕ is a qualitative representation. If there are $x, y, z \in D$ such that $(x, y) \in a^\phi$, $(y, z) \in b^\phi$, $(x, z) \in c^\phi$ then $(a; b \cdot c)^\phi = (a; b)^\phi \cap c^\phi \supseteq a^\phi \circ b^\phi \cap c^\phi \neq \emptyset$, so $a; b \cdot c \neq 0$. If no such x, y, z exist then $a^\phi \circ b^\phi \subseteq (-c)^\phi$ and since $(a; b)^\phi$ is smallest such that $(a; b)^\phi \supseteq a^\phi \circ b^\phi$ it follows that $(a; b)^\phi \subseteq (-c)^\phi$, $(a; b)^\phi \cap c^\phi = \emptyset$, so $a; b \cdot c = 0$.

Conversely assume (2). If $(a; b)^\phi \not\supseteq a^\phi \circ b^\phi$ then there are x, y, z with $(x, y) \in a^\phi$, $(y, z) \in b^\phi$ and $(x, z) \in -(a; b)^\phi$, hence by (2) $a; b \cdot -(a; b) \neq 0$, a contradiction. We conclude $(a; b)^\phi \supseteq a^\phi \circ b^\phi$. If $c^\phi \not\supseteq a^\phi \circ b^\phi$ then there do not exist x, y, z such that $(x, y) \in a^\phi$, $(y, z) \in b^\phi$ and $(x, z) \in (-c)^\phi$ so by (2), $a; b \cdot (-c) = 0$ and $c \geq a; b$, thus $c = a; b$ is the minimal solution in \mathcal{A} of $c^\phi \supseteq a^\phi \circ b^\phi$, this proves that ϕ is correctly represented as weak composition. \square

3. ATOM STRUCTURES AND EXAMPLES

In the case of an atomic algebra, a convenient way of specifying the operators is by defining its *atom structure*.

DEFINITION 5. *Let X be the set of atoms (minimal, non-zero elements) of a non-associative algebra \mathcal{A} . The atom structure $At(\mathcal{A})$ is defined as*

$$At(\mathcal{A}) = (X, E, \smile, C)$$

where E is the set of atoms below the identity, \smile is the converse function restricted to atoms, and C is the set of consistent triples of atoms, that is, those triples of atoms (a, b, c) such that $a; b \geq c$. We write $|At(\mathcal{A})|$ for $|X|$, the cardinality of the set of atoms.

Conversely, given (X, E, \smile, C) , where $E \subseteq X$, \smile is a unary function on X and $C \subseteq X^3$ we may define the complex algebra $\mathfrak{Cm}(X, E, \smile, C) = (\mathcal{P}(X), \emptyset, X, \cup, \setminus, E, \smile, ;)$ where E is the identity element, \smile is extended to sets of atoms by taking unions, and multiplication is defined by $S; T = \{x \in X : \exists s \in S, t \in T (s, t, x) \in C\}$.

For any atomic non-associative algebra \mathcal{A} with atoms X , the map defined by $a \mapsto \{x \in X : x \leq a\}$ is an embedding of \mathcal{A} into $\mathfrak{Cm}(At(\mathcal{A}))$ and in the case where \mathcal{A} is complete and atomic, this map is surjective, i.e. an isomorphism. Observe, for finite algebras, that the number of atoms is the logarithm (base two) of the number of elements of the algebra. It is clear, by additivity, that the constant $1'$ and the operators $\smile, ;$ are determined by the atom structure, when the atom structure is finite and in fact, as we noted earlier, every non-associative algebra is *completely* additive so the operators of an arbitrary atomic, non-associative algebra are determined by its atom structure.

The next lemma is proved in [Mad82, Theorem 2.2(2)].

LEMMA 6. *Let (S, E, \smile, C) consist of a set S , a subset $E \subseteq S$, a unary function $\smile : S \rightarrow S$ satisfying $s \smile \smile = s$, and subset $C \subseteq S \times S \times S$. The following are equivalent*

- (S, E, \smile, C) is the atom structure of some non-associative algebra,
- For all $a, b, c \in S$ we have $a = b$ iff there is $e \in E$ such that $(e, a, b) \in C$, and if $(a, b, c) \in C$ then $(b \smile, a \smile, c \smile) \in C$ and $(c \smile, a \smile, b \smile) \in C$.

The six triples (a, b, c) , $(b, c \smile, a \smile)$, $(c, b \smile, a)$, $(a \smile, c, b)$, $(b \smile, a \smile, c \smile)$, $(c \smile, a \smile, b \smile)$ are called the *Peircean transforms* of (a, b, c) . In practice, the triples are given in *composition tables* such as the one used in Figure 1 to define the point algebra. The entry for

$a; b$ is the join of the set $\{c: (a, b, c) \in C\}$, so if $(a, b, c_1), (a, b, c_2), (a, b, c_3) \in C$, the entry for $a; b$ will be $c_1 + c_2 + c_3$.

In the following examples we define some finite non-associative algebras by giving their atom structures, except for the final example which is defined directly. The examples are not intended to be useful, or even usable, as qualitative calculi; we only wish to illustrate the definitions.

EXAMPLES 7. (1) *The first of our non-associative algebras has three atoms, $\{e, e', a\}$, hence eight elements. The identity is $e + e'$, each element is self-converse, multiplication is defined in the table on the left below*

$;$	e	e'	a
e	e	0	a
e'	0	e'	a
a	a	a	1

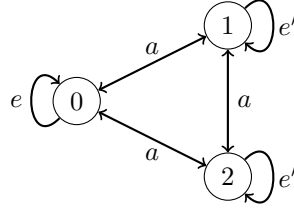

Multiplication is not associative, for example $(e; e'); a = 0; a = 0$ but $e; (e'; a) = e; a = a$. This non-associative algebra has a qualitative representation ϕ over a base of three points $\{0, 1, 2\}$, shown on the right, above: $e^\phi = \text{Id}_{\{0\}}$, $(e')^\phi = \text{Id}_{\{1, 2\}}$ and $a^\phi = \{(x, y) : x \neq y < 3\}$, ϕ is defined on sums of atoms by additivity.

Now let θ be obtained by restricting the qualitative representation ϕ to the base $\{0, 1\}$, illustrated below.

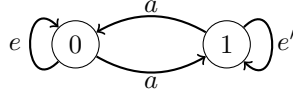

Since $(b; c)^\theta \supseteq b^\theta \circ c^\theta$ for any b, c in the algebra and all atoms are witnessed, θ is a feeble representation over the base $\{0, 1\}$. However, $a^\theta \circ a^\theta = \text{Id}_{\{0, 1\}}$ and $a; a = 1$ is not minimal subject to containing $a^\theta \circ a^\theta$ (the minimal solution is $e + e' < 1$), so θ is not a qualitative representation.

(2) *This non-associative algebra has atoms $\{1', a, a', \times\}$ (so sixteen elements). All elements are self-converse, this time the identity $1'$ is an atom, multiplication is defined by*

$;$	$1'$	a	a'	\times
$1'$	$1'$	a	a'	\times
a	a	$1' + a$	0	\times
a'	a'	0	$1' + a'$	\times
\times	\times	\times	\times	$1' + a + a'$

Again, associativity fails because $(a; a'); a' = 0; a' = 0$ but $a; (a'; a') = a; (1' + a') = a$. A qualitative representation θ on base $\{0, 1, 2\} \cup \{0', 1', 2'\}$, shown below, is defined by $(1')^\theta = \text{Id}_{\{x, x': x < 3\}}$, $a^\theta = \{(m, n) : m \neq n, m, n < 3\}$, $(a')^\theta = \{(m', n') : m' \neq n', m', n' < 3\}$, $\times^\theta = \{(m, n'), (m', n) : m, n < 3\}$.

Here and below, reflexive identity loops have been omitted.

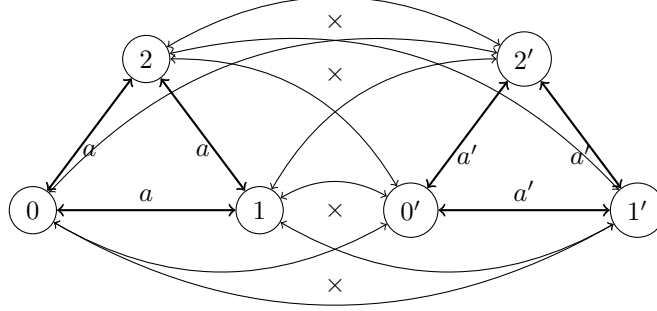

- (3) The next algebra has atoms $\{1', a, b, c\}$ where the identity is $1'$, all atoms are self-converse and multiplication is defined by the table below, known to Maddux as relation algebra 25_{65} , [Mad06]. A strong representation of it is illustrated on the right.

;	$1'$	a	b	c
$1'$	$1'$	a	b	c
a	a	$1'$	c	b
b	b	c	$1'$	a
c	c	b	a	$1'$

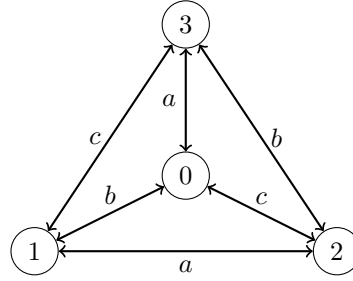

This algebra happens to be associative (hence a relation algebra). The only consistent triples of non-identity atoms are the permutations of (a, b, c) . If we restrict the base to a set of three elements, say $\{1, 2, 3\}$, we obtain a different qualitative representation, no longer a strong representation because although $1' = c; c$ and $(2, 2)$ is in the representation of $1'$, there is no point v in the base $\{1, 2, 3\}$ such that $(2, v)$ and $(v, 2)$ are in the representation of c . This relation algebra can have no qualitative representation, nor even a feeble representation, on a base of more than four points, because it is impossible to colour the edges of the complete graph K_5 using three colours, a, b, c , while avoiding triangles with two edges of the same colour. In fact the two qualitative representations just mentioned are the only qualitative representations of this relation algebra, up to base isomorphism.

- (4) Our next example is a non-associative algebra which does not have a qualitative representation, though it has a feeble one. Its atoms are $\{e, e', a, a^\smile\}$, $1' = e + e'$ and composition is given by

;	e	e'	a	a^\smile
e	e	0	a	0
e'	0	e'	0	a^\smile
a	0	a	a	$a + a^\smile + e$
a^\smile	a^\smile	0	$a + a^\smile + e'$	a^\smile

By Lemma 6 this is the atom structure of a non-associative algebra (not associative because $a = a; a = (a; e'); a \neq a; (e'; a) = a; 0 = 0$). A feeble representation θ on the points 0, 1 is shown below

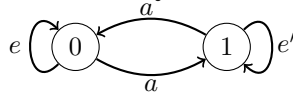

If ϕ were a qualitative representation then since $a; a \cdot a \neq 0$ there would be x, y, z in the base such that $(x, y), (y, z), (x, z) \in a^\phi$ and $(y, y) \in (1')^\phi$. Since $1' = e + e'$ either $(y, y) \in e^\phi$ or $(y, y) \in (e')^\phi$, in the former case $(x, y) \in a^\phi \circ e^\phi \subseteq (a; e)^\phi = 0^\phi$ and in the latter case $(y, z) \in (e'; a)^\phi = 0^\phi$, in each case we get a contradiction.

- (5) Examples of relation algebras not even possessing feeble representations are provided in the proof of Theorem 20 below.
- (6) This example shows that associativity does not suffice to ensure a qualitatively representable algebra has a strong representation. Let \mathcal{K} be McKenzie's non-representable algebra (see [McK70]). It is defined by the following multiplication table for the atoms

;	1'	a	a-tilde	b
1'	1'	a	a-tilde	b
a	a	a	1	a + b
a-tilde	a-tilde	1	a-tilde	a-tilde + b
b	b	a + b	a-tilde + b	-b

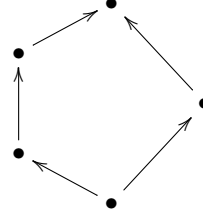

where $b^\vee = b$. As McKenzie showed, it is associative but has no strong representation. Let \mathbf{N}_5 be the pentagon lattice considered as an ordered set, illustrated in the right above. It is easy to show that boolean combinations of the relations $\text{Id}, <, >, \#$ (where $\#$ stands for incomparability), form a herd over $\mathbf{N}_5 \times \mathbf{N}_5$, and the map $1' \mapsto \text{Id}, a \mapsto <, a^\vee \mapsto >, b \mapsto \#$, extends naturally to a qualitative representation of \mathcal{K} . We leave it as an instructive exercise to prove that no qualitative representation can exist over a set with 4 or fewer elements. (Hint: you have to be able to compose incomparability with itself and get $<$ and $>$.)

- (7) Consider the successor relation \prec on the integers \mathbb{Z} , the “much less than” relation \ll denoting strict inequality of distance at least two, their respective converse relations \succ and \gg and equality $=$. The underlying algebra can be obtained from the point algebra (see Figure 1) by splitting the atom $<$ as $\prec + \ll$ and $>$ as $\succ + \gg$, but is nonassociative as $\succ; (\prec; \prec) = \prec + \ll$, while $(\succ; \prec); \prec = \prec$. The qualitative representations of this successor algebra are precisely those over chains in which there are sufficiently many consecutive successors. A digraph is balanced (or levelled) if it admits a homomorphism into the digraph (\mathbb{Z}, \prec) ; every fixed template constraint satisfaction problem in a finite relational language (but not necessarily finite domain) is logspace equivalent to one over a single balanced digraph [BDJN15]. The meta-problem of deciding if a finite digraph is balanced, which is solvable in

nondeterministic logspace, can be taken as constraint problem over qualitative representations of this algebra, in which the input digraph is interpreted as \prec .

- (8) Our final example is an infinite relation algebra, for expressing metric constraints on a linearly ordered metric space. Its elements are finite unions of real intervals, e.g. $(2, 5) \cup [6, 8]$. There is one identity atom, namely $[0, 0]$, converse is defined by $(m, n)^\vee = (-n, -m)$, and composition is defined by $(m, n); (m', n') = (m + m', n + n')$ for $m > n$, $m' > n'$, with similar definitions for closed and semi-open intervals. A strong representation θ over the real numbers may be obtained by letting $(x, y) \in (m, n)^\theta \iff m < y - x < n$, with similar definitions for closed and semi-open intervals. This provides a useful way of expressing metric constraints between points, e.g. the constraint $(x, y) \in ([-3, -2] \cup [2, 3])^\theta$ means that the distance between x and y is at least two and not more than three.

4. SEMI-ASSOCIATIVITY AND ASSOCIATIVITY

In order to axiomatise the class of qualitatively representable algebras we might start by taking the axioms of non-associative relation algebra and add some weakening of the associativity law. Maddux defines two such weakenings: the *semi-associative law* $x ; (1 ; 1) = (x ; 1) ; 1$ and the *weak-associativity law* [Mad82] $(x \cdot 1') ; (1 ; 1) = ((x \cdot 1') ; 1) ; 1$. In the definition of the qualitative calculus given by [LR04] the identity $1'$ is required to be an atom and for this case the weak associativity law is sure to hold (since $x \cdot 1'$ is either 0 or $1'$) as shown in [WHW14, Section 3]. However, when we consider cases where the identity is not an atom, we see that the algebra of Example 7(1) above fails the weak associativity law (and consequently also fails the stronger semi-associativity law) because $(e ; 1) ; 1 = (e + d) ; 1 = 1$ but $e ; (1 ; 1) = e ; 1 = e + d$, so weak associativity is not valid over qualitative representations. On the other hand, since $(a; b)^\theta \supseteq a^\theta \circ b^\theta$, for any qualitative (or feeble) representation θ over domain D , it follows that the equation

$$(1 ; x) ; 1 = 1 ; (x ; 1)$$

is an example of a validity over qualitative (respectively, feeble) representations (in any herd on base D , both sides equal $1 = D \times D$ if $x \neq 0$ and both sides equal 0 if $x = 0$).

An algebra is *integral* if $x ; y = 0 \rightarrow x = 0$ or $y = 0$. It is known for semi-associative algebras that an algebra is integral iff the identity is an atom [Mad90, Theorem 4]. However, in the algebra of Example 7.2 above, the identity is an atom but the algebra is not integral. It follows that this algebra is not semi-associative, indeed $d ; 1 = 1' + d + f$ but $(d ; 1) ; 1 = 1$.

Semi-associativity for weak composition was touched upon in [LR04] where it was shown that if relations are *serial* (have total domains) then the weak composition is semi-associative. In fact, in our more general setting where the identity need not be an atom, it suffices to assume that nonempty relations have pairwise overlapping domains.

LEMMA 8. *Let ϕ be a qualitative representation of a non-associative algebra \mathcal{A} to a herd \mathcal{S} . Then, the following are equivalent:*

- (1) If $a, b \in \mathcal{A} \setminus \{0\}$ then $(a^\phi)^\smile \circ b^\phi \neq \emptyset$ (nonempty relations have overlapping domains),
- (2) \mathcal{A} is integral,
- (3) \mathcal{A} is semi-associative and the identity is an atom.

Proof. As we noted, in semi-associative algebras integrality is equivalent to the identity being an atom so we get (3) \Rightarrow (2). To prove (2) \Rightarrow (3) we will show that integrality implies semi-associativity in non-associative algebras. Working backwards, suppose semi-associativity fails in \mathcal{A} . By monotonicity of composition in non-associative algebras, since $1' \leq 1$, we have $x ; (1; 1) = x ; 1 \leq (x ; 1) ; 1$, for any $x \in \mathcal{A}$. Thus, the failure of semi-associativity is witnessed by some $0 \neq a \in \mathcal{A}$ such that $a ; 1 < (a; 1) ; 1$. So, there is $(a; 1) ; 1 \geq b \neq 0$ such that $a ; 1 \cdot b = 0$. But then, $a^\smile ; b \cdot 1 = 0$ by the Peircean law, and so $a^\smile ; b = 0$ where $a^\smile, b \neq 0$ and the algebra is not integral. Thus the equivalence of (2) and (3) is true in any non-associative algebra.

To prove the equivalence of (2) and (1), observe that $a = 0 \iff a^\smile = 0$ and $(a^\smile)^\phi \circ b^\phi = \emptyset \iff (a^\smile ; b)^\phi = \emptyset \iff a^\smile ; b = 0$, using the fact that $c = a^\smile ; b$ is the minimal solution of $c^\phi \supseteq (a^\smile)^\phi \circ b^\phi$. \square

Let \mathcal{A} be a non-associative algebra, and ϕ be a qualitative representation, i.e. a map from A to $\mathcal{P}(D \times D)$ for some set D satisfying the conditions of Definition 3. Consider the following condition on ϕ :

$$(*) \quad (a^\phi \circ b^\phi) \cap (c^\phi \circ d^\phi) = \emptyset \iff (a; b) \cdot (c; d) = 0.$$

Intuitively, (*) says that two consistent triangles share a label (the right-hand side) if and only if a quadrangle witnessing this fact can be found in the representation (the left-hand side). Observe that the right-to-left implication holds for any qualitative representation ϕ , since $(x; y)^\phi \supseteq x^\phi \circ y^\phi$.

THEOREM 9. *If there exists a qualitative representation of \mathcal{A} satisfying (*), then \mathcal{A} is associative.*

Proof. To prove associativity, let $a, b, c, d \in \mathcal{A}$ be arbitrary. Then

$$\begin{aligned}
((a; b); c) \cdot d = 0 &\iff (a; b) \cdot (d; c^\smile) = 0 && \text{by Peircean law for ;} \\
&\iff (a^\phi \circ b^\phi) \cap (d^\phi \circ c^\smile)^\phi = \emptyset && (*) \\
&\iff ((a^\phi \circ b^\phi) \circ c^\phi) \cap d^\phi = \emptyset && \text{Peircean law for } \circ \\
&\iff (a^\phi \circ (b^\phi \circ c^\phi)) \cap d^\phi = \emptyset && \text{associativity of } \circ \\
&\iff (b^\phi \circ c^\phi) \cap (a^\smile)^\phi \circ d^\phi = \emptyset && \text{Peircean law for } \circ \\
&\iff (b; c) \cdot (a^\smile; d) = 0 && (*) \\
&\iff (a; (b; c)) \cdot d = 0 && \text{Peircean law for ;}
\end{aligned}$$

Since d is arbitrary it follows that $(a; b); c = a; (b; c)$. \square

Observe that the McKenzie algebra \mathbf{K} is associative, but its qualitative representation of over the base \mathbf{N}_5 does not satisfy (*), because we have $(\# \circ <) \cap (\# \circ >) = \emptyset$ whereas $(b; a) \cdot (b; a^\smile) = b$. However, there is a qualitative representation of \mathbf{K} satisfying (*), for example over the base $D = \{\perp, a_1, b_1, c_1, a_2, b_2, c_2, \top\}$ with $<$ defined as the transitive closure of $\perp < a_1 < b_1 < c_1 < \top$, $\perp < a_2 < b_2 < c_2 < \top$.

The following conjecture remains open: if \mathcal{A} is associative and has a qualitative representation then it has a qualitative representation satisfying (*).

5. NETWORK SATISFACTION PROBLEM

DEFINITION 10. Let \mathcal{A} be a non-associative algebra. A network (N, λ) over \mathcal{A} consists of a finite set N of nodes and a function $\lambda : (N \times N) \rightarrow \mathcal{A}$. A network (N, λ) is consistent if

- (a) $\lambda(x, x) \leq 1'$,
- (b) $\lambda(x, y); \lambda(y, z) \cdot \lambda(x, z) \neq 0$, for all nodes $x, y, z \in N$,
- (c) $\lambda(x, y) \cdot \lambda(y, x) \neq 0$,
- (d) $\lambda(x, y) \neq 0$, for all nodes $x, y \in N$.

A network (N, λ) is path-consistent (or algebraically closed) if it is consistent and additionally $\lambda(x, y); \lambda(y, z) \geq \lambda(x, z)$, for all $x, y, z \in N$. An atomic network (N, λ) is a network where $\lambda(x, y)$ is always an atom of \mathcal{A} . Every consistent atomic network is path-consistent.

A network (N, λ) embeds into a strong representation ϕ if there is a map ι from N to the base of ϕ such that for all $x, y \in N$ we have $(\iota(x), \iota(y)) \in \lambda(x, y)^\phi$, similarly (N, λ) embeds into a qualitative representation θ if there is a map ι from N to the base of a qualitative representation θ such that for all $x, y \in N$ we have $(\iota(x), \iota(y)) \in \lambda(x, y)^\theta$. A network over \mathcal{A} is strongly satisfiable if it embeds into some strong representation of \mathcal{A} and it is qualitatively satisfiable if it embeds into some qualitative representation of \mathcal{A} . Clearly, if (N, λ) is strongly satisfiable then it is qualitatively satisfiable.

A strong representation ϕ of the finite relation algebra \mathcal{A} is fully universal if every consistent atomic network embeds into ϕ (sometimes these representations are known as canonical).

Note that the conditions (c) and (d) for a consistent network follow from (a) and (b) (see [HH02, Lemma 7.2]), so we could have left them out of the definition, but since they are naturally expected nonetheless, we decided to keep them in. Our definition of a *consistent network* coincides with what Hirsch and Hodkinson [HH02] call a *network*. We believe this less restrictive definition of a network (essentially, just as a labelled complete directed graph) to be more convenient in the present context as it is closer to the standard terminology used in the area of qualitative calculi as well as in constraint satisfaction.

REMARK 11. Consider the non-associative algebra of Example 7.1. It has a qualitative representation, but since it is not associative it can have no strong representation. The network shown in Example 7.1 is qualitatively satisfiable but not strongly satisfiable.

Let \mathcal{A} be an atomic relation algebra. If \mathcal{A} has a fully universal representation then any network is qualitatively satisfiable iff it is strongly satisfiable. It is known that the point and interval algebras have fully universal representations [LM94] and it follows from results in [BW11] that RCC8 has a fully universal representation, hence for these three relation algebras a network is strongly satisfiable iff it is qualitatively satisfiable. (Moreover, [BW11] shows that every ω -categorical relation algebra has a fully universal representation, hence for these algebras strong satisfiability agrees with qualitative satisfiability.)

LEMMA 12. Let \mathcal{A} be a finite non-associative algebra. \mathcal{A} has a qualitative representation if and only if there is a consistent atomic network (N, λ) over \mathcal{A} such that for each consistent triple of atoms (a, b, c) of \mathcal{A} there are nodes $x, y, z \in N$ such that $\lambda(x, y) = a$, $\lambda(y, z) = b$ and $\lambda(x, z) = c$.

Proof. Let ϕ be a qualitative representation over base D . For each $x, y \in D$ let $\lambda(x, y)$ be the (unique) atom a such that $(x, y) \in a^\phi$, such an atom must exist since \mathcal{A} is finite. Clearly (D, λ) is consistent and atomic, though it might be infinite. Furthermore, if a, b, c are atoms such that $a ; b \geq c$ then there must be x, y, z with $\lambda(x, y) = a$, $\lambda(y, z) = b$ and $\lambda(x, z) = c$, by Lemma 4. Hence there is a finite subset $D_0 \subseteq D$ such that the restriction of λ to D_0 is atomic, consistent and therefore an atomic network, and still witnesses all triples of atoms,

Conversely, if (N, λ) is a consistent atomic network witnessing all consistent triples of atoms then the binary relation \sim over the nodes of N defined by $x \sim y \iff N(x, y) \leq 1'$ is easily seen to be an equivalence relation, indeed a congruence. The equivalence class of a node x is denoted $[x]$. We may define a qualitative representation ϕ whose base is the set of all \sim -equivalence classes, by

$$a^\phi = \{([x], [y]) : N(x, y) \leq a\}$$

for $a \in \mathcal{A}$. Since \sim is a congruence ϕ is well-defined, since edges are labelled by atoms ϕ respects the boolean operators, since the network is consistent it is clear that ϕ respects the converse operator, and since $N(x, y) \leq 1' \iff [x] = [y]$ the identity is correctly represented. By Lemma 4, ϕ is a qualitative representation. \square

LEMMA 13. *If \mathcal{A} is a finite, qualitatively representable, atomic non-associative algebra then \mathcal{A} has a qualitative representation with at most $3|At(\mathcal{A})|^3$ points in its base.*

Proof. By the previous lemma, if \mathcal{A} is qualitatively representable then there is a consistent atomic network witnessing all consistent triples of atoms. There are at most $|At(\mathcal{A})|^3$ such triples, so $3|At(\mathcal{A})|^3$ points suffice to witness them all. The atomic network defined by restricting to this set of up to $3|At(\mathcal{A})|^3$ points is consistent and still witnesses all consistent triples of atoms, hence it defines a qualitative representation of the required size, by the proof of the right to left implication of Lemma 12. \square

The upper bound of Lemma 13 seems to overestimate the necessary size of a qualitative representation rather largely. Although we will not try to provide a sharper bound here, we will present an illustrative example. Consider RCC5: a version of RCC8 with no distinction between “tangential” and “non-tangential” connectedness. Its composition table is

	$1'$	ε	ε^\vee	π	δ
$1'$	$1'$	ε	ε^\vee	π	δ
ε	ε	ε	1	$\varepsilon + \pi + \delta$	δ
ε^\vee	ε^\vee	$1' + \varepsilon + \varepsilon^\vee + \pi$	ε^\vee	$\varepsilon^\vee + \pi$	$\varepsilon^\vee + \pi + \delta$
π	π	$\varepsilon + \pi$	$\varepsilon^\vee + \pi + \delta$	1	$\varepsilon^\vee + \pi + \delta$
δ	δ	$\varepsilon + \pi + \delta$	δ	$\varepsilon + \pi + \delta$	1

with ε , π and δ interpreted intuitively as proper part, proper overlap, and disjointness relations, respectively. This algebra has a qualitative representation over a

base consisting of just eleven “regions”, namely, the following subsets of $\{1, \dots, 7\}$:

$$\begin{array}{lll} A = \{1, 6\} & B = \{1, 2, 3, 5, 6\} & C = \{1, 2, 6\} \\ D = \{1, 2, 3, 5, 6, 7\} & E = \{1\} & F = \{1, 2, 3, 5\} \\ G = \{2, 3\} & H = \{1, 4, 6\} & I = \{1, 3\} \\ J = \{1, 2, 3, 4, 5\} & K = \{4, 5, 6\} & \end{array}$$

with the relations ε , π and δ mapped, respectively, to proper subset relation, nonempty symmetric difference relation, and empty intersection relation. Our representation on the 11 regions A, \dots, K was obtained with the help of the model-finder `mace4`; we conjecture that it is the smallest number of regions possible for a qualitative representation of RCC5. Incidentally, it also shows that standard off-the-shelf tools can be used to find qualitative representations.

REMARK 14. *The study of syllogistics [Aristotle, Prior Analytics] can be described using RCC5. Namely, setting:*

$$\begin{array}{ll} \text{Every } S \text{ is } P & \text{iff } (S, P) \in 1' + \varepsilon \\ \text{Some } S \text{ is } P & \text{iff } (S, P) \in 1' + \varepsilon + \varepsilon^\vee + \pi \\ \text{No } S \text{ is } P & \text{iff } (S, P) \in \delta \\ \text{Some } S \text{ is not } P & \text{iff } (S, P) \in \varepsilon^\vee + \pi + \delta \end{array}$$

we obtain a faithful interpretation of traditional logic of categorical propositions.

We turn to questions of computational complexity. We say that a finite atom structure has a qualitative representation if its complex algebra has one. We begin with a result that contrasts with the corresponding question for strong representations which is known to be undecidable [HH01b].

THEOREM 15. *The problem of determining whether a finite atom structure has a qualitative representation is **NP-complete**.*

Proof. If a finite atom structure with n atoms has a qualitative representation then, by Lemma 13, it has a qualitative representation of size at most $3n^3$. Hence a non-deterministic algorithm may simply construct a base with up to $3n^3$ points and guess an atom between each pair of points, then check to see if the resulting network is consistent and that every consistent triple of atoms is witnessed (see Lemma 12). Since the run-time of this non-deterministic algorithm is bounded by a polynomial function, we conclude that the qualitative representation problem is in **NP**.

For **NP-hardness**, we reduce the *3-colour graph vertex problem* for finite graphs. Let $G = (V, \mathcal{E})$ be a finite graph with vertices V and directed edges \mathcal{E} , where this edge set is symmetric and irreflexive. Cases where $\mathcal{E} = \emptyset$ are trivially 1-colourable, so we assume $\mathcal{E} \neq \emptyset$. If we extend G by adding some isolated vertices to V it will not affect the 3-colourability of the graph, so we assume that G has an independent set of size 5 (formally, there are $v_0, v_1, \dots, v_4 \in V$ such that $(v_i, v_j) \notin E$, for $i, j < 5$) and a triangle containing one edge and two non-edges (there are $u, v, w \in V$ such that $(u, v) \in E$ but $(u, w), (v, w) \notin E$). Next, we extend G to $G^\infty = (V^\infty, \mathcal{E}^\infty)$, by adding a single node connected to all the nodes of V , i.e. $V^\infty = V \cup \{\infty\}$, $\mathcal{E}^\infty = \mathcal{E} \cup \{(\infty, u), (u, \infty) : u \in V\}$, where $\infty \notin V$. It is clear that G^∞ is 4-colourable if

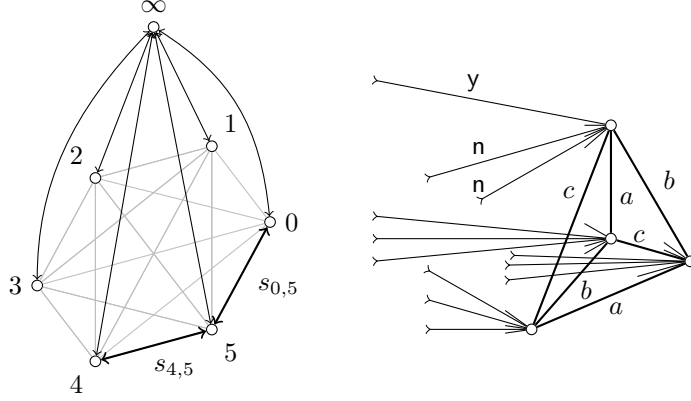

FIGURE 3. A schematic diagram of the intended qualitative representation for (S, E, \checkmark, C) , when G is 3-colourable. The graph G^∞ is on the left, with vertex set $\{0, 1, 2, 3, 4, 5, \infty\}$ and edges shown in black. An independent set can be found on the five vertices $\{0, 1, 2, 3, 4\}$ and a triple of vertices with one edge can be found at $\{0, 1, 5\}$. The vertex ∞ is adjacent to all vertices and nonedges are shown in grey (and would be labeled by g). On the right, there is a second tetrahedral graph on 4 vertices (with names $\gamma_1, \gamma_2, \gamma_3, \gamma_4$ omitted) and with undirected edges a, b, c as in Example 7.3. Edges connecting the graph G^∞ to these vertices are labelled y or n , according to the colour of the vertex of G^∞ .

and only if G is 3-colourable. Because G has an independent set of size 5, any 4-colouring of G^∞ must include non-adjacent nodes of the same colour, and because of the triangle with one edge and two non-edges any colouring must include non-adjacent nodes of different colours.

We define a non-associative atom structure (S, E, \checkmark, C) as follows. The set of atoms is

$$S = \{1'\} \cup S_{GG} \cup S_{CC} \cup S_{GC} \cup S_{CG}$$

where $S_{GG} = \{s_{uv} : (u, v) \in \mathcal{E}^\infty\} \cup \{g\}$ (graph atoms, here g is a symbol not appearing in V^∞ , used for non-edges), $S_{CC} = \{a, b, c\}$ (colouring atoms), $S_{GC} = \{y, n\}$ (used to map graph nodes to colours) and $S_{CG} = \{y^\checkmark, n^\checkmark\}$ (the converses of S_{GC}). The identity is an atom $E = \{1'\}$, and all atoms are self-converse except $s_{uv}^\checkmark = s_{vu}$ and the converses of y, n are $y^\checkmark, n^\checkmark$ respectively. [The intention here is that atoms s_{uv} will be used to encode the edges (u, v) of the graph G^∞ , g (“gap”) corresponds to non-edges and the atoms $a, b, c \in S_{CC}$ will encode the undirected edges of a graph with no more than four nodes (see Examples 7.3) and these nodes will represent distinct colours. y, y^\checkmark (“yes”) and n, n^\checkmark (“no”) will be used to connect this set of up to four nodes to the nodes of G^∞ while encoding a legitimate 4-colouring. A schematic of the desired qualitative representation is shown in Figure 3.]

All Peircean transforms of the following triples of atoms are forbidden.

- (I) $(1', x, y)$ where $x \neq y$, (identity law)
- (II) (α, β, γ) , where $\alpha \in S_{IJ}$, $\beta \in S_{J'K'}$ and $\gamma \in S_{I^*K^*}$, unless $I = I^*$, $J = J'$, $K' = K^*$ ($\in \{G, C\}$) (types must match),

- (III) (α, α, β) where $\alpha, \beta \in S_{CC}$, (see Examples 7.3, only permutations of the triple (a, b, c) are consistent for S_{CC} atoms),
- (IV) $(s_{uv}, s_{v'w'}, \alpha)$ where $(u, v), (v', w') \in \mathcal{E}^\infty$, unless $v = v'$ (node indices must match),
- (V) $(s_{uv}, s_{vw}, \mathbf{g})$ where $(u, v), (v, w) \in \mathcal{E}^\infty$ and either $(u, w) \in \mathcal{E}^\infty$ or $u = w$, (\mathbf{g} only allowed on non-edges),
- (VI) $(s_{\infty u}, \alpha, \mathbf{g})$ where $u \in V$, $\alpha \in S_{GG}$ (∞ adjacent to all other nodes),
- (VII) $(\mathbf{y}, \alpha, \mathbf{y})$ where $\alpha \in S_{CC}$ (only one colour per node)
- (VIII) $(s_{uv}, \mathbf{y}, \mathbf{y})$ where $(u, v) \in \mathcal{E}^\infty$ (adjacent nodes have different colours)

The set C of consistent triples of atoms consists of all triples not forbidden by (I)–(VIII), above.

The reduction maps (V, \mathcal{E}) to the atom structure (S, E, \checkmark, C) just defined. We check that this reduction is correct. Suppose ρ is a 4-colouring of the vertices of G^∞ such that adjacent nodes have different colours, there are non-adjacent nodes of the same colour and non-adjacent nodes of different colours. Let the colours be $\gamma_1, \gamma_2, \gamma_3, \gamma_4$. We define an atomic network (N, λ) where $N = V^\infty \cup \{\gamma_1, \gamma_2, \gamma_3, \gamma_4\}$. For the labelling λ we let $\lambda(x, x) = 1'$ (all $x \in N$), $\lambda(u, v) = s_{uv}$ for $(u, v) \in \mathcal{E}^\infty$, $\lambda(u, v) = \mathbf{g}$ if $u \neq v \in V^\infty$, $(u, v) \notin \mathcal{E}$. As in the strong representation for Examples 7.3, let $\lambda(\gamma_1, \gamma_2) = \lambda(\gamma_3, \gamma_4) = a$, $\lambda(\gamma_1, \gamma_3) = \lambda(\gamma_2, \gamma_4) = b$, $\lambda(\gamma_1, \gamma_4) = \lambda(\gamma_2, \gamma_3) = c$ and $\lambda(\gamma_j, \gamma_i) = \lambda(\gamma_i, \gamma_j)$ for $1 \leq i < j \leq 4$. Finally, for each $u \in V^\infty$ and for $1 \leq i \leq 4$, let $\lambda(u, \gamma_i) = \mathbf{y}$ if $\rho(u) = \gamma_i$ else (if $\rho(u) \neq \gamma_i$) $\lambda(u, \gamma_i) = \mathbf{n}$. The atoms \mathbf{y} and \mathbf{n} are used to label the converse edges for edges labelled \mathbf{y}, \mathbf{n} respectively. It is a routine check that this defines a consistent atomic network. Since there are non-adjacent nodes of the same colour the triple $(\mathbf{g}, \mathbf{y}, \mathbf{y})$ is witnessed and since there are non-adjacent nodes of different colours $(\mathbf{g}, \mathbf{y}, \mathbf{n})$ and $(\mathbf{g}, \mathbf{n}, \mathbf{y})$ are also witnessed. It is easily checked that every other consistent triples of atoms are also witnessed hence, by Lemma 12, the complex algebra over (S, E, \checkmark, C) is qualitatively representable.

For the converse, let (N, λ) be any complete, consistent atomic network witnessing each consistent triple and containing no forbidden triples for the atom structure (S, E, \checkmark, C) : in other words, (N, λ) provides a qualitative representation of (S, E, \checkmark, C) . We show that G^∞ is 4-colourable, hence G is 3-colourable. By forbidden triple II, a triple (α, β, γ) is forbidden if exactly one or all three of α, β, γ belongs to $S_{GC} \cup S_{CG}$. Hence the edges labelled by atoms in $S_{GC} \cup S_{CG} = \{\mathbf{y}, \mathbf{y}^\checkmark, \mathbf{n}, \mathbf{n}^\checkmark\}$ form a complete bipartite graph on N , say N is the disjoint union of N_1 and N_2 . By forbidden triple II again, every edge with source in N_1 (say) and target in N_2 has a label in S_{GC} , every edge with source in N_2 and target in N_1 has a label in S_{CG} , edges with source and target within N_1 have label in $\{1'\} \cup S_{GG}$ and edges with source and target in N_2 have label in $\{1'\} \cup S_{CC}$.

Now we show that $|N_1| = |V^\infty|$ and that the labels s_{uv} define a graph on N_1 isomorphic to G^∞ . Let $u \in V$ and let $\infty', u' \in N_1$ denote the source and target of some edge labelled by $s_{\infty u}$. For each $x \in N_1 \setminus \{\infty'\}$ the edge (∞', x) must be labelled by $s_{\infty v}$ for some $v \in V$ by forbidden triples II, IV and VI, and if (∞', y) is also labelled by $s_{\infty v}$ then $x = y$ by forbidden triple V. Hence there is a bijection $\prime : V^\infty \rightarrow N_1$ mapping ∞ to ∞' and mapping $v \in V$ to the unique $v' \in N_1$ such that (∞', v') is labelled $s_{\infty v}$. So we may assume that N_1 is identical to the set V^∞ , and that the label of each edge (∞, w) (for $w \in V$) is $s_{\infty w}$. By forbidden triples IV and V we see that the label of the edge (u, v) is s_{uv} if $(u, v) \in \mathcal{E}$, $1'$ if $u = v$ and \mathbf{g}

otherwise. By forbidden triple III, N_2 cannot have more than four points, (we saw in Examples 7.3 that N_2 has either three or four points).

Let $u \in N_1$. As (y, y, α) is always forbidden by VII, there is at most one edge labelled y leaving u and because (s_{vu}, y, n) is consistent and the edge labelled s_{vu} is unique (where $(u, v) \in \mathcal{E}$), there is exactly one edge labelled y leaving u . Thus, we may define a map $\rho : V^\infty \rightarrow N_2$ by letting $\rho(u)$ be the unique element of N_2 such $\lambda(u, \rho(u)) = y$, for each $u \in V^\infty = N_1$. Since (s_{uv}, y, y) is forbidden by VIII whenever $(u, v) \in \mathcal{E}^\infty$, ρ is a valid 4-colouring of G^∞ . \square

THEOREM 16. *Let \mathcal{A} be a finite non-associative algebra. The network qualitative satisfaction problem over \mathcal{A} is in NP.*

Proof. For each consistent triple of atoms t , let (T_t, λ_t) be a partially labelled atomic network with three nodes, witnessing the consistent triple of atoms. Assume for distinct consistent triples t, s that $T_t \cap T_s = \emptyset$. Given a network (N, λ) , take the disjoint union of (N, λ) and the disjoint partial triangles (T_t, λ_t) as t ranges over consistent triples of atoms. Then, non-deterministically guess all unlabelled edges and for each edge (x, y) of N , guess an atom below $\lambda(x, y)$. Finally check that the resulting atomic network is consistent. By Lemma 12, this correctly tests qualitative satisfiability and runs non-deterministically in polynomial time. \square

A traditional approach to solving the network satisfaction problem (for strong representations) is to refine a given network to a *path consistent* network on the same nodes. This path-consistent refinement may be computed deterministically in cubic time. If the refined network is inconsistent (has a zero label) then the original network is unsatisfiable. There are some algebras where the converse also holds — if the refined network is consistent then the original network must be satisfiable — for example, path-consistency entails satisfiability for networks over the *Point Algebra* [VKvB89, Theorem 5]. However, for many relation algebras the converse fails, for example, there are known path-consistent but unsatisfiable networks over the Allen Interval Algebra [All83, Figure 5]. The Allen Interval algebra possesses a *fully universal representation* (see Definition 10), so the satisfiability of a network may be tested along the lines of the proof of the preceding theorem, by non-deterministically picking an atom below the label of each edge of the network and checking the consistency of the resulting atomic refinement. Such satisfiability checkers may run faster if a network is first refined to a path-consistent network, before the non-deterministic choice of atoms is made. For algebras which do not have fully universal representations however, it is not sufficient to find a consistent atomic refinement of a network, for example, there are consistent atomic networks over the interval-with-duration calculus INDU, not satisfiable in any strong representation (see our remarks in Section 1.1). Indeed there are finite relation algebras for which the network satisfaction problem is undecidable [Hir99].

Nevertheless, for qualitative representations the non-deterministic algorithm given in the preceding theorem is necessary and sufficient for qualitative representability. Hence in general the network qualitative satisfaction problem can have much lower complexity than the network satisfaction problem.

THEOREM 17. *The problem of determining whether an equation is valid over qualitative representations is **co-NP-complete**.*

Proof. Let $t(\bar{x}) = s(\bar{x})$ be an equation that fails in some herd \mathcal{S} , where $\bar{x} = (x_0, \dots, x_{k-1})$ is a finite tuple of variables. Then $t(\bar{a})^{\mathcal{S}} \neq s(\bar{a})^{\mathcal{S}}$ holds for some tuple $\bar{a} = (a_0, \dots, a_{k-1})$ of relations in the herd \mathcal{S} and there is a pair of points x, y from the base of \mathcal{S} such that (x, y) belongs to one but not the other of $t(\bar{a})^{\mathcal{S}}$ and $s(\bar{a})^{\mathcal{S}}$. Let X be a finite subset of the base of \mathcal{S} including x and y and also including, for each subterm $p; q$ occurring in either s or t , three points u, v, w such that $(u, v) \in p$ and $(v, w) \in q$, provided such points exist in the base of \mathcal{S} . The size of X is at most three times the length of the equation $t(\bar{x}) = s(\bar{x})$. Let $\mathcal{S}|_X$ be the herd on the base X consisting of the relations $\{r \cap (X \times X) : r \in \mathcal{S}\}$. Lemma 4 and a simple induction shows that $(u, v) \in p(a_0, \dots, a_{k-1})^{\mathcal{S}} \iff (u, v) \in p(a_0 \cap (X \times X), \dots, a_{k-1} \cap (X \times X))^{\mathcal{S}|_X}$, for any $u, v \in X$ and any subterm $p(\bar{x})$ of either $t(\bar{x})$ or $s(\bar{x})$. Hence (x, y) belongs to one but not the other of $t(a_0 \cap (X \times X), \dots, a_{k-1} \cap (X \times X))^{\mathcal{S}|_X}$, $s(a_0 \cap (X \times X), \dots, a_{k-1} \cap (X \times X))^{\mathcal{S}|_X}$ and the equations $t(\bar{x}) = s(\bar{x})$ fails in a herd on a base of size at most three times the length of the equation. Thus, the failure of the equation may be tested non-deterministically by choosing a base of size at most three times the length of the equation, guessing which pairs of points belong to each of the relations x_0, \dots, x_{k-1} and verifying that the equation fails. This proves that the validity of equations problem is **co-NP**.

Validity is **co-NP-hard** because the validity problem for propositional formulas reduces to it. \square

The reader has probably guessed, or knows already, that the corresponding problem for strongly representable relation algebras is much harder: the equational theory of strongly representable relation algebras is undecidable [Tar41].

6. FEEBLE REPRESENTATIONS

We mentioned earlier that [LR04, Definition 3] only requires $(a; b)^\phi \supseteq a^\phi \circ b^\phi$ in their definition of weak composition, and do not insist on minimality subject to that (although elsewhere in their paper they imply a definition which accords with our definition of qualitative representation, see Definition 3.4). In this section we investigate this weaker type of representability. Although qualitative representations are of greater relevance to much of the literature in qualitative calculi, feeble representations are more directly related to research on the binary constraint satisfaction problem, where for any constraints a, b and a solution for variables x, y, z , we may infer from $a(x, y)$, $b(y, z)$ that $(a \circ b)(x, z)$ holds, but there is no requirement, given $(a \circ b)(x, z)$, that there should be three variables x', y', z' such that $a(x', y')$ and $b(y', z')$.

Let \mathcal{A} be a non-associative algebra and let $\phi : \mathcal{A} \rightarrow \mathcal{P}(D \times D)$ (some base D) respect the boolean operators, represent $1'$ as the identity and respect the converse operator. If $(a; b)^\phi \supseteq a^\phi \circ b^\phi$ (for all $a, b \in \mathcal{A}$) then ϕ is called a feeble qualitative representation, or simply a feeble representation, of \mathcal{A} . The proof of the following lemma is very similar to the proof of Lemma 12.

LEMMA 18. *Let \mathcal{A} be a finite non-associative algebra. \mathcal{A} has a feeble representation if and only if there is a consistent atomic network (N, λ) over \mathcal{A} such that for every atom a of \mathcal{A} there are $x, y \in N$ with $\lambda(x, y) = a$.*

In a feeble representation of a finite algebra, instead of requiring a witness for each consistent triple of atoms, we only require a witness for each single atom, while avoiding any forbidden triple of atoms.

One obvious shortcoming of this notion is that a feeble representation of an algebra \mathcal{A} does not determine \mathcal{A} , because some consistent triples may be absent in the representation. Indeed, we saw that the herd on a base of two points shown in the second part of Example 7.1 provides a feeble representation of two non-isomorphic non-associative algebras: the algebra of Example 7.1 and the algebra of Example 7.4. Unfortunately, the complexity of the feeble representation problem remains the same as that of the qualitative representation problem.

THEOREM 19. *The problem of determining whether a finite atom structure has a feeble representation is **NP-complete**.*

Proof. If a finite atom structure with n atoms has a feeble representation then we may restrict the base to a set of at most $2n$ points so that all atoms are still witnessed in the restriction, hence the atom structure has a feeble representation of size at most $2n$. Thus, a non-deterministic algorithm may guess an atomic labelling over a set of at most $2n$ points and check if the labelling defines a feeble representation. So the feeble representation problem is in **NP**.

For **NP-hardness**, we reduce the *Monochromatic Triangle* problem for finite graphs. Let $G = (V, \mathcal{E})$ be a finite graph with vertices V and directed, irreflexive, symmetric edges \mathcal{E} (i.e. $(u, v) \in \mathcal{E} \iff (v, u) \in \mathcal{E}$). The *Monochromatic Triangle* problem asks if there is a 2-colouring of the edges, that is, a symmetric function $\rho : \mathcal{E} \rightarrow \{r, b\}$ such that ρ is not constant over the three edges of any triangle of the graph. This problem is known to be **NP-complete**, see [GJ79, p. 191]. Any complete graph with six or more nodes is a no instance, hence we will only consider instances of this problem containing at least one non-edge.

Given a symmetric, irreflexive graph $G = (V, \mathcal{E})$, we define a non-associative atom structure (S, E, \checkmark, C) as follows.

$$S = \{1'\} \cup \{\times\} \cup S_{GG} \cup S_{\infty G} \cup S_{G\infty}$$

where $S_{GG} = \{c_{uv} : c \in \{r, b\}, (u, v) \in \mathcal{E}\} \cup \{g\}$, $S_{\infty G} = \{p_u, q_u : u \in V\}$ and $S_{G\infty} = \{p_u, q_u : u \in V\}$. The identity is an atom $E = \{1'\}$ and converse is defined by $c_{uv} \checkmark = c_{vu}$ (for any $c \in \{r, b\}$ and $(u, v) \in \mathcal{E}$), the converses of p_u, q_u are p_u, q_u and $1', \times, g$ are self-converse. Let C consist of all triples of atoms except for Peircean transforms of the following forbidden triples of atoms.

- (I) $(1', x, y)$, where $x \neq y$,
- (II) (\times, \times, \times) and (\times, α, β) , where $\times \notin \{\alpha, \beta\}$,
- (III) (α, β, γ) where $\alpha \in S_{IJ}$, $\beta \in S_{J'K}$ and any atom γ , unless $J = J'$,
- (IV) $(p_u, c_{u_1 v}, p_{v_1}), (q_u, c_{u_1 v}, q_v)$, any $c \in \{r, b\}$ any $u, u_1, v, v_1 \in V$, unless $u = u_1$ and $v = v_1$,
- (V) $(p_u, g, p_v), (q_u, g, q_v)$, where $(u, v) \in \mathcal{E}$ or $u = v$,
- (VI) (p_u, α, q_v) , for any atom α and any $u, v \in V$,
- (VII) (c_{uv}, c_{vw}, c_{uw}) , any $c \in \{r, b\}$ and any $u, v, w \in V$.

Note that the set of atoms does not include a subset $S_{\infty\infty}$, so triples III and II forbid all triples of non-identity atoms of the form (α, β, γ) where $\alpha \in S_{\infty G}$ and $\beta \in S_{G\infty}$, thus $p_u; p_u \checkmark$ equals $1'$ if $u = v$ else it is zero, for all $u, v \in V$. Also, there are no atoms c_{uu} for $c \in \{r, b\}$ since $(u, u) \notin \mathcal{E}$, so by forbidden triples II, III IV, V we have $p_u; p_u = 1'$. Similarly $q_u; q_u \leq 1'$ and $q_u; q_u = 1'$.

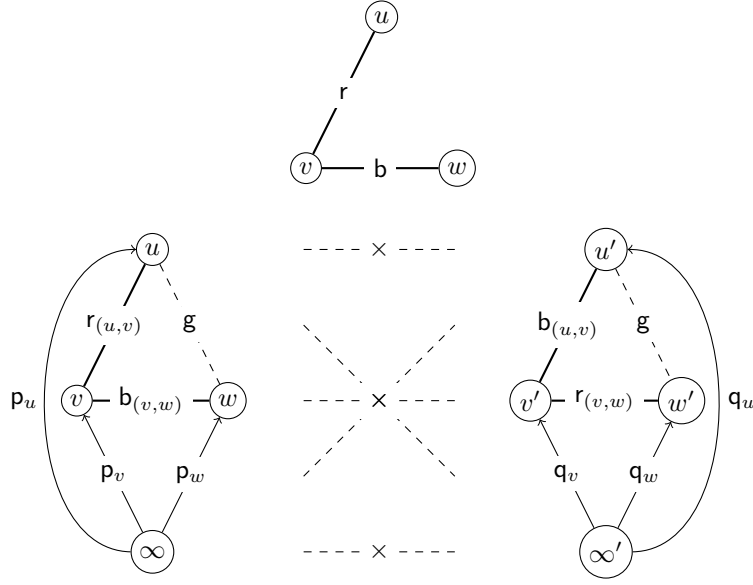

FIGURE 4. A 2-colouring of the edges $(u, v), (v, w)$ of a graph with nodes u, v, w (above) and a consistent atomic network witnessing all atoms in (S, E, \circ, C) , obtained from it (below). The atomic network determines a feeble representation.

The reduction maps (V, \mathcal{E}) to the complex algebra of the atom structure (S, E, \circ, C) just defined. Before we prove the correctness of this reduction, we mention the intended roles of the atoms. Given any consistent, atomic network witnessing all atoms, the atom \times will define a bipartite edge relation over the set of nodes of the network (as in Examples 7.2). Each part of the network contains a copy of the graph together with a single auxiliary node and will encode a valid colouring of the graph, with atoms r_{uv} and b_{uv} encoding edges coloured red and blue, respectively, while g (“gap”) corresponds to non-edges. The atom p_u labels the edge from the auxiliary node to u in one part of the network while the atom q_u is used in the other part. They are used to ensure that the encoding describes the way edges fit together correctly. Conversely, given an arbitrary edge colouring of G there is dual colouring obtained by swapping red and blue edge labels. By using the colouring on one copy of G and the dual colouring on another copy of G we may construct a consistent, atomic network in which each atom r_{uv} and b_{uv} is witnessed. Such an atomic network is illustrated in Figure 4, based on a two colouring of a three node graph.

Now we make this more precise by checking that the reduction is correct. Suppose $\rho : \mathcal{E} \rightarrow \{r, b\}$ is a symmetric colouring avoiding monochrome triangles. Let V_+ consist of the nodes of V together with a single extra point ∞ and let $V'_+ = \{x' : x \in V_+\}$ be a set of the same size as V_+ disjoint from it. We will define an atomic network $(V_+ \cup V'_+, \lambda)$ avoiding all forbidden triples (so consistent) and witnessing every atom, thereby showing that the complex algebra over (S, E, \circ, C)

has a feebly representation. To define λ :

$$\begin{aligned}
\lambda(x, x) &= 1' & x \in V_+ \cup V'_+ \\
\lambda(x, y') &= \times & x \in V_+, y' \in V'_+ \\
\lambda(\infty, u) &= \mathbf{p}_u & u \in V \\
\lambda(\infty', u') &= \mathbf{q}_u & u \in V \\
\lambda(u, v) &= c_{uv} & (u, v) \in \mathcal{E}, \rho(u, v) = c \in \{\mathbf{r}, \mathbf{b}\} \\
\lambda(u', v') &= \bar{c}_{uv} & (u, v) \in \mathcal{E}, \rho(u, v) = c \\
\lambda(u, v) &= \lambda(u', v') = \mathbf{g} & (u, v) \notin \mathcal{E}, u \neq v
\end{aligned}$$

where \bar{c} denotes ‘the other colour’, for $c \in \{\mathbf{r}, \mathbf{b}\}$, and each converse edge is labelled by the converse atom, e.g. $\lambda(u, \infty) = \mathbf{p}_u^\smile$. It is a routine check that this defines a consistent atomic network and that every atom labels at least one edge. By Lemma 18, (S, E, \smile, C) has a feebly representation.

For the converse, suppose the complex algebra over (S, E, \smile, C) has a feebly representation, by Lemma 18 there is a consistent, atomic network (N, λ) witnessing all atoms. We must show that G is a yes instance of the monochromatic triangle problem.

By forbidden triple II we have that for any $x, y, z \in N$ either none or exactly two of $\{\lambda(x, y), \lambda(x, z), \lambda(y, z)\}$ equal \times . It follows that the set of pairs $\{(x, y) : x, y \in N, \lambda(x, y) = \times\}$ forms a complete bipartite graph with nodes N . So N is the disjoint union $N_1 \cup N_2$, say, and $\lambda(x, y) = \times$ iff either $x \in N_1, y \in N_2$ or $x \in N_2, y \in N_1$.

Since all atoms are witnessed there are nodes $z, x \in N$ such that $\lambda(z, x) = \mathbf{p}_u$, without loss $z, x \in N_1$. By forbidden triple III, for every $y \in N_1 \setminus \{z\}$ the label $\lambda(z, y)$ belongs to $S_{\infty G}$, so it is \mathbf{p}_v or \mathbf{q}_v for some $v \in V$, but it cannot be \mathbf{q}_v by forbidden triple VI. By forbidden triples IV and V,

$$\lambda(x, y) = \begin{cases} 1' & \text{if } u = v \\ c_{uv} & \text{if } (u, v) \in \mathcal{E}, \text{ for some } c \in \{\mathbf{r}, \mathbf{b}\} \\ \mathbf{g} & \text{otherwise} \end{cases}$$

Hence the map $*$: $N_1 \setminus \{z\} \rightarrow V$ which maps $y \in N_1 \setminus \{z\}$ to $v \in V$ iff $\lambda(z, y) = \mathbf{p}_v$ is a well-defined injection. Since each atom \mathbf{p}_v is witnessed in the network $*$ is surjective, hence a bijection from N_1 onto V . Define a function $\rho : \mathcal{E} \rightarrow \{\mathbf{r}, \mathbf{b}\}$ by letting $\rho(u^*, v^*) = c$ if $\lambda(u, v) = c_{uv}$, for $c \in \{\mathbf{r}, \mathbf{b}\}$. Since $r_{uv}^\smile = r_{vu}$ and $b_{uv}^\smile = b_{vu}$ this colouring function is symmetric. By forbidden triple VII, ρ is a valid colouring of the graph. \square

7. AXIOMATISABILITY

THEOREM 20. *If \mathcal{K} is a class of algebras containing all strongly representable relation algebras and contained in the class of all feebly representable non-associative algebras, then \mathcal{K} has no finite axiomatisation in first order logic.*

Proof. An edge of a set S is an unordered pair of distinct elements of S , for finite S there are $\frac{|S| \times (|S| - 1)}{2}$ edges. An n -colouring of a set S is a function ρ mapping edges of S to a set of n colours, avoiding monochromatic triangles. Let $n \geq 3$, let $k(n)$ be the smallest integer such that there is no n -colouring on a set with $k(n)$ or

more edges and let α_n be the atom structure with atoms

$$\{1'\} \cup \{a_0^k : k < k(n)\} \cup \{a_i : 0 < i < n\}$$

Atoms disjoint from the identity are called diversity atoms. We regard the subscript i of any diversity atom as the colour of the atom, so all atoms a_0^k have colour 0. All atoms are self-converse. All triples of atoms are consistent except those of the form $(1', x, y)$ for $x \neq y$ (and Peircean transforms of these) and triples of atoms of the same colour, i.e. (a_i, a_i, a_i) for $0 < i < n$ or $(a_0^k, a_0^{k'}, a_0^{k*})$, for $k, k', k^* < k(n)$. Let \mathcal{A}_n be the complex algebra of α_n (sometimes called a *Monk Algebra*, see [HH02, Definition 15.2]). Then \mathcal{A}_n has no feebly representation because any atomic network witnessing all atoms has at least $k(n)$ distinct edges (one for each atom a_0^k), but no such network can be consistent since there is no n -colouring of a set with this many edges.

Now consider a non-principal ultraproduct $\mathcal{A} = \prod_{n \in \omega} \mathcal{A}_n / U$ of the \mathcal{A}_n , where U is a non-principal ultrafilter over ω . Let $0' = -1' \in \mathcal{A}$ be the sum of all the diversity atoms. The following first-order properties are true in each \mathcal{A}_n .

- 1:** each algebra is atomic, integral and all elements are self-converse
- 2:** there is z_0 disjoint from the identity such that $z_0; z_0 = -z_0$ (consider the element $a_0 = \sum_{k < k(n)} a_0^k \in \mathcal{A}_n$) and for any non-zero x, y disjoint from the identity

$$(x; y \geq 0') \vee (x = y \wedge x; y = -x) \vee (x, y \leq z_0 \wedge -z_0 \cdot 0' \leq x; y \leq -z_0)$$

- 3_k:** ($k < n$)

$$\forall x_0, \dots, x_{k-1} \left(\sum_{i < k} x_i \geq 0' \rightarrow \bigvee_{i < k} \forall y (y \not\leq 1' \rightarrow x_i; y \geq 0') \right).$$

To see why (2) is true in \mathcal{A}_n observe that for any two non-zero elements x, y disjoint from the identity, either x, y contain atoms of different colours (so their product is $\geq 0'$), $x = y = a_i$ (some i with $1 \leq i < n$) or $x, y \leq a_0$, so at least one of the three disjuncts must hold. Similarly for (3_k), where $k < n$, by the pigeon-hole principle, if $\sum_{i < k} x_i \geq 0'$ then there must be at least one $i < k$ such that x_i contains atoms of more than one colour, hence $x_i; y \geq 0'$ for all $y \not\leq 1'$. Since the first two properties are true in every \mathcal{A}_n ($n \in \omega$) and (3_k) holds in cofinitely many \mathcal{A}_n , all of these properties hold in the ultraproduct \mathcal{A} , by Loś' theorem.

We claim that \mathcal{A} is a strongly representable relation algebra. Since RRA is a variety, it suffices to prove that every finitely generated subalgebra of \mathcal{A} is strongly representable. For this, let $F \subseteq \mathcal{A}$ be any finite set. By adding if necessary, we may assume that F includes the element $z_0 \in \mathcal{A}$ required to exist by (2) and the identity $1' \in \mathcal{A}$. The boolean algebra $\langle F \rangle$ generated in \mathcal{A} by F has at most $2^{|F|}$ atoms and consists of arbitrary sums of them. Clearly $\langle F \rangle$ includes the identity and is closed under converse, since we assume $1' \in F$ and all elements of \mathcal{A} are self-converse. And by (2), $\langle F \rangle$ is also closed under composition, hence it is a finite sub-relation algebra of \mathcal{A} . By (3_k) where $k = 2^{|F|}$, one of the atoms f of $\langle F \rangle$ is *flexible*, i.e. for any diversity atom g of $\langle F \rangle$ we have $f; g \geq 0'$. It is known that every integral relation algebra with a flexible atom is strongly representable [Com84] or [Mad82, Theorem 5.19], so $\langle F \rangle$ is a strongly representable relation algebra. Since every finitely generated subalgebra of \mathcal{A} is strongly representable, \mathcal{A} is also strongly representable, as claimed.

Thus, none of the algebras \mathcal{A}_n has a feeble representation so $\mathcal{A}_n \notin \mathcal{K}$ (for $n < \omega$) but an ultraproduct \mathcal{A} of them has a strong representation and is in \mathcal{K} . By Łoś' Theorem, \mathcal{K} cannot be defined by finitely many axioms. \square

By this theorem, the following classes cannot be defined by finitely many axioms: the class of non-associative algebras with feeble representations; with qualitative representations; with strong representations.

8. CONCLUSION

Let us review some of the advantages of qualitative representations. For many applications in knowledge representation, it is natural to express that a certain relation *may* be decomposed in a certain way without insisting that such a decomposition must always exist, for example if one asserts that y occurs strictly later than x , it might be the case that there is a z occurring in between, but not necessarily. In order to model real world applications using relation-like algebras, it is often necessary to consider a type of representation for our algebras that would be ruled out if we were to restrict ourselves to strong representations. For relation algebras such as RCC8 where we may wish to consider disconnected regions and regions with holes it has been known for some time that strong relation algebra representations are problematic. So the fact that qualitative representations include along with strong representations a very wide class of different representations, significantly extends our ability to model various situations.

Moreover, if a finite algebra has a qualitative representation then it has a qualitative representation on a finite base. This means, in general, that the network satisfaction problem is much easier for qualitative representations than the corresponding problem for strong representations, although for certain well-known relation algebras the two versions of the problem turn out to be equivalent. We have seen that several representation problems become computationally much easier in the context of qualitative representations compared to the corresponding strong representation problem.

In a subsequent paper we intend to investigate the fully universal algebra of QRA in more depth, by providing a recursive (but necessarily infinite) axiomatisation of it, by considering *complete* qualitative representations (strengthening Definition 3(2) to $(\Sigma X)^\phi = \bigcup_{x \in X} x^\phi$), and by showing that QRA generates a variety with very strong structural properties (technically, a *discriminator* variety).

ACKNOWLEDGEMENT

The authors wish to thank Dr. Todd Niven for his essential input in the early development of this work.

REFERENCES

- [All83] James Allen. Maintaining knowledge about temporal intervals. *Communications of the ACM*, 26:832–843, 1983.
- [Aristotle, Prior Analytics] Aristotle. Prior Analytics. English translation available at <http://classics.mit.edu/Aristotle/prior.mb.txt>. 350 BCE.
- [BW11] Manuel Bodirsky and Stefan Wöfl. RCC8 is polynomial on networks of bounded treewidth. *Proceeding of the twenty-second international joint conference on Artificial Intelligence*, 2: 756–761, 2011.
- [BDJN15] J. Bulín, D. Delic, M. Jackson and T. Niven, A finer reduction of constraint problems to digraphs, *Logical Methods in Computer Science* 11(4:18)2015, pp. 1–33.

- [CCL⁺15] Juan Chen, Anthony G. Cohn, Dayou Liu, Shengsheng Wang, Jihong Ouyang, and Qiangyuan Yu. A survey of qualitative spatial representations. *The Knowledge Engineering Review*, 30:106–136, 1 2015.
- [Com84] Stephen D. Comer. Combinatorial aspects of relations. *Algebra Universalis*, 18:77–94, 1984.
- [DWM01] Ivo Düntsch, Hui Wang, and Steve McLoskey. A relation-algebraic approach to the region connected calculus. *Theoretical Computer Science*, 255:63–83, 2001.
- [GJ79] Michael R. Garey and David S. Johnson. *Computers and Intractability: A Guide to the Theory of NP-Completeness*. W. H. Freeman & Co., New York, NY, USA, 1979.
- [HH01a] Robin Hirsch and Ian Hodkinson. Relation algebras from cylindric algebras, II. *Ann. Pure. Appl. Logic*, 112:267–297, 2001.
- [HH01b] Robin Hirsch and Ian Hodkinson. Representability is not decidable for finite relation algebras. *Trans. Amer. Math. Soc.*, 353:1403–1425, 2001.
- [HH02] Robin Hirsch and Ian Hodkinson. *Relation algebras by games*. North-Holland. Elsevier Science, Amsterdam, 2002.
- [Hir96] Robin Hirsch. Relation Algebras of Intervals. *Artificial Intelligence Journal*, 83:1–29, 1996.
- [Hir99] Robin Hirsch. A relation algebra with undecidable network satisfaction problem. *Bulletin of the Interest Group in Pure and Applied Logics*, 7(4):547–554, 1999.
- [JT51] Bjarni Jónsson and Alfred Tarski. Boolean algebras with operators I. *American Journal of Mathematics*, 73:891–939, 1951.
- [KL91] Henry Kautz and Peter Ladkin. Integrating metric and qualitative temporal reasoning. *AAAI'91, Proceedings of the ninth National conference on AI*, 1:241–246, 1991.
- [Koz97] Dexter Kozen. Kleene algebra with tests. *ACM Trans. Program. Lang. Syst.*, 19(3):427–443, 1997.
- [Lee14] Jae Lee. The complexity of reasoning with relative directions. *Frontiers in Artificial Intelligence and Applications*, ECAI: 507–512, 2014.
- [Lig05] Gérard Ligozat. Categorical methods in qualitative reasoning: The case for weak representations. In *Spatial Information Theory, International Conference, COSIT 2005, Elliotville, NY, USA, September 14-18, 2005, Proceedings*, pages 265–282, 2005.
- [Lig11] Gérard Ligozat. *Qualitative spatial and temporal reasoning*. Wiley-ISTE, 2011.
- [LL:10] Sanjian Li and Weiming Liu. Topological Relations between Convex Regions. AAAI Conference on Artificial Intelligence, North America, 2010.
- [LM88] Peter Ladkin and Roger Maddux. On binary constraint networks. Technical Report U.88.8, Kestrel Institute, 1988.
- [LM94] Peter Ladkin and Roger Maddux. Constraint problems. *Journal of the Association of Computing Machinery*, 41:435–469, 1994.
- [LMW] Domink Lüke, Till Mossakowski and Diedrich Wolter. Qualitative reasoning about convex relations. In: Freksa C., Newcombe N.S., Gärdenfors P., Wöfl S. (eds) *Spatial Cognition VI. Learning, Reasoning, and Talking about Space*. Spatial Cognition. Lecture Notes in Computer Science, vol 5248. Springer, Berlin, Heidelberg, 2008.
- [LR04] Gérard Ligozat and Jochen Renz. What is a qualitative calculus? A general framework. In Chengqi Zhang, Hans W. Guesgen, and Wai-Kiang Yeap, editors, *PRICAI*, volume 3157 of *Lecture Notes in Computer Science*, pages 53–64. Springer, 2004.
- [LW06] Sanjian Li and Huaiqing Wang. RCC8 binary constraint network can be consistently extended. *Artificial Intelligence Journal*, 170:1–18, 2006.
- [Mad82] Roger Maddux. Some varieties containing relation algebras. *Trans. Amer. Math. Soc.*, 272(2)(2):501–526, 1982.
- [Mad90] Roger Maddux. Necessary subalgebras of simple nonintegral semiassociative relation algebras. *Algebra Universalis*, 27:544–558, 1990.
- [Mad06] Roger Maddux. *Relation algebras*, volume 150 of *Studies in Logic: the Foundations of Mathematics*. Elsevier, 2006.
- [McK70] Ralph McKenzie. Representations of integral relation algebras. *Michigan Math. J.*, 17:279–287, 1970.
- [Mei96] Itay Meiri, Combining qualitative and quantitative constraints in temporal reasoning *Artificial Intelligence Journal*, 87:343–385, 1996.

- [MSW06] Till Mossakowski, Lutz Schröder, and Stefan Wöfl. A categorical perspective on qualitative constraint calculi. In *Qualitative Constraint Calculi: Applications and Integration*, pages 28–39, 2006.
- [OW08] Joël Ouaknine and James Worrell. Some recent results in metric temporal logic. In *LNCS*, 5215:1–13, 2008.
- [PKS99] Arun Pujari, Vijaya Kumari and Abdul Sattar. INDu: An Interval and Duration Network. In *Advanced topics and artificial intelligence, LNCS*, 1747, 1999.
- [RCC92] David A. Randell, Zhan Cui, and Anthony G. Cohn. A spatial logic based on regions and connection. In *Proceedings 3rd International Conference on Knowledge Representation and Reasoning*. Morgan Kaufmann, 1992.
- [Ren02] Jochen Renz. The region connected calculus. In: Renz J. (eds) *Qualitative Spatial Reasoning with Topological Information*. Lecture Notes in Computer Science, vol 2293. Springer, Berlin, Heidelberg, 2002.
- [RL05] Jochen Renz and Gérard Ligozat. Weak composition for qualitative spatial and temporal reasoning. In *Proceedings of Constraint Programming*, volume 3709 of *LNCS*, page 534–548, 2005.
- [Tar41] Alfred Tarski. On the calculus of relations. *Journal of Symbolic Logic*, 6:73–89, 1941.
- [VKvB89] M Vilain, H Kautz, and P van Beek. Constraint propagation algorithms for temporal reasoning — a revised report. In D S Weld and J de Kleer, editors, *Readings in Qualitative Reasoning about Physical Systems*, pages 373–381. Morgan Kaufmann, 1989.
- [WHW14] Matthias Westphal, Julien Hué, and Stefan Wöfl. On the scope of qualitative constraint calculi. In *KI 2014: Advances in Artificial Intelligence - 37th Annual German Conference on AI, Stuttgart, Germany, September 22-26, 2014. Proceedings*, pages 207–218, 2014.