

PhD - 1977 - S.M. FRANKENSTEIN - VOL. 2.

BEST COPY

AVAILABLE

Variable print quality

BIBLIOGRAPHY

Abbreviations used

AJA	American Journal of Archaeology
AEArq	Archivo Español de Arqueología
BASOR	Bulletin of the American School of Oriental Research
Bonner Jb	Bonner Jahrbücher
BRGK	Bericht der Römisch-Germanischen Kommission
BSA	Annual of the British School at Athens
CAH	Cambridge Ancient History
CNA	Congreso Nacional de Arqueología II Madrid 1951 X Mahon 1967 XI Mérida 1968 XII Jaén 1971 XIII Huelva 1973
Exc. Arq. en España	Excavaciones Arqueológicas en España
FbS	Fundberichte aus Schwaben
Jb RGZM	Jahrbuch des Römisch-Germanischen Zentralmuseums Mainz
JCS	Journal of Cuneiform Studies
JHS	Journal of Hellenic Studies
JNES	Journal of Near Eastern Studies
MDOG	Mitteilungen der Deutschen Orient-Gesellschaft
MM	Madridier Mitteilungen
NAH	Noticario Arqueológico Hispánico
PBSR	Papers of the British School at Rome
PEQ	Palestine Exploration Quarterly
PPS	Proceedings of the Prehistoric Society
SCE	Swedish Cyprus Expedition
SIPP	Symposium Internacional de Prehistoria Peninsular, V Jerez de la Frontera 1968: Tartessos y sus Problemas, <u>Publicaciones Eventuales 13</u>
SPP	Symposium de Prehistoria Peninsular VI Palma de Mallorca 1972
Trab. de Preh.	Trabajos de Prehistoria



ADCOCK F E

1926 The reform of the Athenian State; CAH IV, Ch. II, IV and V, 36-45

ALBRIGHT W F

1941 New light on the early history of Phoenician colonisation, BASOR 83, (Oct.) 14-22

1942 Archaeology and the Religion of Israel, Baltimore

1958 Was the age of Solomon without monumental art? Eretz-Israel V, 1ff

1961 The role of the Canaanites in the history of civilization in WRIGHT G E ed. The Bible and the Ancient Near East, New York

1963 The Archaeology of Palestine, Harmondsworth (1st publ. 1949)

ALDRED C

1963 The Egyptians, London

ALLAN J C

1970 Considerations on the Antiquity of Mining in the Iberian Peninsula, Royal Anthropological Institute, Occ. Paper no. 27

ALMAGRO BASCH M

1940 El hallazgo de la ría de Huelva y el final de la edad del bronce en el occidente de Europa, Ampurias II, 85-143

1943 Tres nuevos hallazgos del bronce final en España, Ampurias V, 270ff

1947-48 Sobre la fijación de las invasiones indoeuropeas en España, Ampurias IX-X, 326-330

1952 La invasión céltica en España in MENENDEZ PIDAL R ed. Historia de España T.I, vol. II - I, 3-278, Madrid

1958 Origen y formación del pueblo hispano, Barcelona

1966 Las estelas decoradas del suroeste peninsular, Biblioteca Prae-histórica Hispana VIII, Madrid

1970 Dos nuevas estelas decoradas de la Andalucía oriental, XI CNA, 315ff, Zaragoza

1975 Depósito de bronce de la ría de Huelva in ALMAGRO M et al Huelva: prehistoria y antigüedad, 213-220, Madrid

ALMAGRO GORBEA M

1971 La necrópolis de Medellín (Badajoz), NAH XVI, 159-202

1974a Orfebrería del bronce final en la península ibérica, Trab. de Preh. 31 39-90

1974b Los tesoros de Sagrajas y Berzocana y los torques de oro macizo del occidente peninsular; Actas do III Congreso Nacional de Arqueologia I, 259ff, Porto

1974c The Bodonal de la Sierra gold find; Journal of the Royal Society of Antiquaries of Ireland, 104, 44-51

1975. Pozo Moro y el origen del arte ibérico, XIII CNA, 671-686, Zaragoza
- ALVES DIAS M M, DE MELO BEIRÃO C, and COELHO L
- 1970 Duas necrópoles da idade do ferro no Baixo-Alentejo; Ourique,
O Arq.Port. S III, IV, 175ff
- DEL AMO Y DE LA HERA M
- 1973 Cerámica de "retícula bruñida" en Medellín, XII CNA, 375ff, Zaragoza
- 1975 Enterramientos en cista de la provincia de Huelva in ALMAGRO M et al
Huelva: prehistoria y antigüedad, 109-192, Madrid
- ANDREWES A
- 1974 The Greek Tyrants, London
- ARRIBAS A
- 1963 The Iberians, London
- 1967 Nuevos hallazgos fenicios en la costa andaluza mediterránea,
Zephyrus 18, 121ff
- ARRIBAS A y Grupo O.J.E. de Málaga
- 1969 El yacimiento paleopúnico de la desembocadura del río Guadalhorce
(Málaga), X CNA, 359-362, Zaragoza
- ARRIBAS A and WILKINS J
- 1969 Lanecrópolis fenicia del Cortijo de las Sombras (Frigiliana, Malaga)
Pyrenae 5, 185-244
- ARRIBAS A et al
- 1974 Excavaciones en el poblado de la Edad del Bronce del Cerro de la
Encina' Monachil (Granada). El corte estratigráfico no. 3.
Exc.Arq. en Espana 81, Madrid
- ARRIBAS A and ARTEAGA O
- 1976 Guadalhorce. Eine phöniko-punische Niederlassung bei Málaga,
MM 17, 180-208
- ARTEAGA O and SERNA M
- 1973 Los Saladares. Un yacimiento protohistórico en la region del Bajo
Segura, XII CNA, 437-50, Zaragoza
- 1974 Die Ausgrabungen von Los Saladares, Prov. Alicante, MM 15, 108-121
- 1975 Los Saladares - 71, NAH Arqueologia 3, 7-140
- DE ASCENÇÃO E BRITO M A
- 1968 Contributo para a classificação de alguns achados de Alcácer do Sal
(Época pré-romana), Coimbra
- ASTOUR M
- 1965 The origins of the terms "Canaan", "Phoenician" and "Purple",
JNES 24, 346ff
- ÅSTRÖM L and ÅSTRÖM P
- 1972 The Late Cypriote Bronze Age, SCE IV 1D, Lund

- ASTRUC M
1951 La necrópolis de Villaricos, Informes y Memorias 25, Madrid
- AUBERSON P and SCHEFOLD K
1972 Führer durch Eretria, Bern
- AUBET M^a E
1969 Selección de bibliografía moderna para el análisis de los problemas de Tartessos, V SIPP, 407-17, Barcelona
- 1971a Los marfiles orientalizantes de Praeneste, Publicaciones Eventuales Barcelona
- 1971b Los hallazgos púnicos de Osuna, Pyrenae 7, 111-127
- 1974a Excavaciones en Las Chorreras (Mezquitilla, Málaga), Pyrenae 10, 79ff
- 1974b Estudios sobre el período orientalizante, II, Valladolid
- AUBET M^a E, MAASS-LINDEMANN G and SCHUBART H
1975 Chorreras. Eine phönizische Niederlassung östlich der Algarrobo-Mündung, MM 16, 137-178
- AUFDERMAUER J
1963 Ein Grabhügelfeld der Hallstattzeit bei Mauenheim, Kr. Donaueschingen, Badische Fundberichte, Sonderheft 3
- AUSTIN M M
1970 Greece and Egypt in the Archaic Age, Cambridge Philological Society Supplement 2
- AUSTIN M and VIDAL-NAQUET P
1972 Economies et sociétés en Grèce ancienne, Paris
- AUTRAN C
1920 "Phéniciens". Essai de contribution à l'histoire antique de la méditerranée. Paris
- BALDACCHINO J G
1952 Report on the working of the Museum Dept. for the year 1950-51, Malta
- BALDACCHINO J G and DUNBABIN T J
1953 Rock tomb at Ghajn Qajjet, near Rabat, Malta, PBSR VIII, 32-41
- BALMUTH M
1967 Monetary forerunners of coinage in Phoenicia and Palestine in antiquity in KINDLER A ed. The Patterns of Monetary Development in Phoenicia and Palestine in Antiquity, 24ff, Jerusalem
- 1971 Remarks on the appearance of the earliest coins in MITTEN D G et al eds. Studies presented to George M.A. Hanfmann, 1-8, Mainz
- 1975 The critical moment: the transition from currency to coinage in the eastern Mediterranean, World Archaeology 6, no. 3, 293-98
- BALY D and TUSHINGHAM A D
1971 Atlas of the Biblical World, New York

- BAKKER L and NIEMEYER H G
 1975 Toscanos. Vorbericht über die Grabungskampagne 1973, Archäologischer Anzeiger, 96-108
- BARAMKI D C
 1958 A late bronze age tomb at Sarafend, Ancient Sarepta, Berytus XII, fasc. II, 129ff
 1961 Phoenicia and the Phoenicians, Beirut
- BARNETT R D
 1939 Phoenician and Syrian ivory carving, PEQ, 4-19
 1948 Early Greek and Oriental ivories, JHS LXVIII, 1-25
 1956a Phoenicia and the ivory trade, Archaeology 9, no. 2, 87-97
 1956b Ancient oriental influences on Archaic Greece in WEINBERG S ed. The Aegean and the Near East, New York
 1957 A catalogue of the Nimrud Ivories with other examples of ancient Near Eastern ivories in the British Museum, London
 1958 Early shipping in the Near East, Antiquity XXXII, 220-230
 1963 Hamath and Nimrud, Iraq XXV, 81-85
 1969 The Sea Peoples, CAH², II, Ch. XXVIII
- BARNETT R D and WATSON W
 1952 Russian excavations in Armenia, Iraq XIV, 132ff
- BARRECA F
 1965 Monte Sirai - II, Studi Semitici 14
- BASS G F ed.
 1967 Cape Gelidonya: A Bronze Age Shipwreck. Transactions of the American Philosophical Society, Philadelphia
- BECK A
 1974 Der hallstattzeitliche Grabhügel von Tübingen-Kilchberg, Fundberichte aus Baden Württemberg, 1, 251-81
- BELOCH K J
 1913 Griechische Geschichte. I: Die Zeit vor den Perserkriegen. Zweite Abteilung, Strasburg (2nd ed.)
- BELTRAN A
 1960 La indoeuropeización del valle del Ebro, I SPP, 103-124, Pamplona
- BEN DOR I
 1967 Phoenicians in Spain and excavations at Rio Tinto, 1966, AJA 71, 183
- BENOIT F
 1965 Recherches sur l'Hellénisation du Midi de la Gaule, Gap
- BÉRARD C
 1970 Eretria III. L'Hérôon à la porte de l'ouest, Bern

BÉRARD J

1957 La colonisation grecque de l'Italie meridionale et de la Sicile dans l'antiquité. L'histoire et la légende. Paris

VAN BERCHEM D

1967 Sanctuaires d'Hercule-Melqart. Contribution à l'étude de l'expansion phénicienne en Méditerranée, Syria XLIV, 73-109

BERTHOLET A

1934 Festus Avienus. Ora Maritima, Paris

BIRD D G

1972 The Roman gold mines of North-West Spain, Bonner Jb. 172, 36-64

BIRMINGHAM J M

1961 The overland route across Anatolia in the 8th and 7th centuries BC, Anatolian Studies XI, 185ff

BISI A M

1968 I pettini d'avorio di Cartagine, Africa II, 11-76

1970 La ceramica punica, Napoli

BITTEL K and RIETH A

1951 Die Heuneburg an der oberen Donau ein frühkeltischer Fürstensitz, Stuttgart and Köln

BLAKEWAY A

1935 Prolegomena to the study of Greek commerce with Italy, Sicily and France in the eighth and seventh centuries BC, BSA XXXIII, 170ff

BLANCE B

1964 The Argaric bronze age in Iberia, Rev. de Guimarães, 74, 129-42

1971 Die Anfänge der Metallurgie auf der Iberischen Halbinsel, Studien zu den Anfängen der Metallurgie, 4, Berlin

BLANCO FREIJEIRO A

1953 El vaso de Valdegamas (Don Benito, Badajoz) y otros vasos de bronce del mediodía español, AEArq 26, 235ff

1956 Orientalia: estudio de objetos fenicios y orientalizantes en la península, AEArq 29, 4ff

1960 Orientalia II, AEArq 33, 3-43

1962 Antigüedades de Riotinto, Zephyrus XIII, 31-45

BLANCO FREIJEIRO A and LUZÓN NOGUE J M

1966 Mineros antiguos españoles, AEArq 39, 73ff

1969 Pre-Roman silver mines at Riotinto, Antiquity XLIII, 124-131

1975 Resultados de las excavaciones del primitivo poblado de Río Tinto in ALMAGRO M et al Huelva: prehistoria y antigüedad, 235ff, Madrid

BLANCO FREIJEIRO A and LUZÓN J M and RUIZ MATA D

1969 Panorama tartésico de Andalucía Oriental, V SIPP, 119-162, Barcelona

- 1970 Excavaciones arqueológicas en el Cerro Salomón (Riotinto, Huelva). Anales de la Universidad Hispalense 4, Serie: Filosofía y Letras, Sevilla
- BLANCO DE TORRECILLAS C
- 1959 El tesoro del Cortijo de "Évora" (Sanlúcar de Barrameda) Cádiz, AEArq 32, 50-7
- DE BLAS CORTINA M A
- 1975 Un interesante molde para fundir hachas de cubo y anillas, XIII CNA, 507-12, Zaragoza
- BLÁZQUEZ J M
- 1963a Joyas orientalizantes extremeñas del Museo Arqueológico Nacional de Madrid, Zephyrus 14, 5-15
- 1963b Jarros piriformes tartésicos de bronce en la Hispanic Society of America y en el Metropolitan Museum of New York, Zephyrus 14, 121-23
- 1968 Tartessos y los orígenes de la colonización fenicia en occidente, Acta Salmanticensia 58, Salamanca
- 1969 Fuentes griegas y romanas referentes a Tartessos, V SIPP, 91-110, Barcelona
- 1975 2nd ed. of 1968, Acta Salmanticensia 85, Salamanca
- BLÁZQUEZ J M, LUZÓN J M, GÓMEZ F and CLAUS K
- 1970 Huelva Arqueologica. Las cerámicas del Cabezo de San Pedro, Inst. de Estudios Onubenses "Padre Marchena", Madrid
- BLÁZQUEZ J M, LUZÓN J M and RUIZ MATA D
- 1971 La factoria púnica de Aljaraque en la provincia de Huelva, NAH XIII-XIV, 304ff
- BLEGEN C W
- 1952 Two Athenian grave groups of about 900 BC, Hesperia XXI, 279ff
- BOARDMAN J
- 1957 Early Euboean pottery and history, BSA 52, 1. - 29
- 1965 Tarsus, Al Mina and Greek chronology, JHS 85, 5-15
- 1970 Euboean pottery in West and East, Dialoghi di Archeologia 3 (1969), 102-4, 156-9
- 1973 The Greeks Overseas, Harmondsworth (2nd ed.)
- BOCHART S
- 1646 Geographiae sacrae pars prior: Phaleg, seu de dispersione gentium et terrarum divisione facta in aedificatione turris Babel, etc. (Geographiae sacrae pars altera: Chanaan, seu de coloniis et sermone phoenicum), Cadomi
- BONSOR G
- 1899 Les colonies agricoles préromaines de la Vallée du Betis, Paris
- 1928 Early engraved Ivories in the Collection of the Hispanic Society of America, New York

BONSOR G and THOUVENOT G

1928 Nécropole ibérique de Setefilla, Lora del Río (Sevilla). Fouilles de 1926-27, Bibl. de l'Ecole des Hautes Etudes Hispaniques, Fasc.XIV.

BOSCH - GIMPERA P

1929 Fragen der Chronologie der Phönizischen Kolonisation in Spanien, Klio 22, 345-68

1932a Etnología de la Península Ibérica, Barcelona

1932b La edad del bronce en la península ibérica, Investigación y Progreso, 145ff

1939 Two Celtic waves in Spain, Proc. Brit. Acad. XXVI, Oxford

1945 La formación de los Pueblos de España, Mexico

1952 Problemas de la historia fenicia en el Extremo Occidente, Zephyrus III, 15-30

BRAUDEL P

1972 The Mediterranean and the Mediterranean World in the Age of Philip II, Vol. I and II, London (2nd ed.)

BREA B

1966 Sicily before the Greeks, London (2nd ed.)

BREASTED J H

1905 A History of Egypt, London

1923 Ancient records of Egypt. Historical Documents. Vol. IV, Chicago (2nd ed.)

BRIARD J

1965 Les dépôts bretons et l'age du bronze Atlantique, Rennes

BRINKMAN J A

1973 Sennacherib's Babylonian problem: an interpretation, JCS XXV, 89-95

BROWN J P

1969 The Lebanon and Phoenicia. Ancient Texts illustrating their Physical Geography and Native Industries, Vol. I. The Physical setting and the Forest, Beirut

BUCHNER G

1964 Contribution to discussion in Metropoli e Colonie di Magna Grecia, Atti del I° Convegno di studi sulla Magna Grecia, Taranto 1963, 263-74, Naples

1966 Pithekoussai: oldest Greek colony in the West, Expedition, 8, 4, 4-12

1970 Mostra degli scavi di Pithecusa, Dialoghi di Archeologia 3 (1969), 85-101

1971 Recent work at Pithekoussai (Ischia) 1965-1971, Archaeological Reports 1970-71, 63-7

- BUNNENS G
 1976 Commerce et diplomatie phéniciens au temps de Hiram I^{er} de Tyre, Journal of the Econ. and Soc. Hist. of the Orient XIX, Part 1, 1-31
- BURGESS C B
 1968a The later Bronze Age in the British Isles and north-western France, Archaeological Journal 125, 1-45
 1968b Bronze Age Metalwork in Northern England c. 1000 to 700 B.C. Newcastle upon Tyne
 1974 The bronze age in RENNIFREW C ed. British Prehistory: A new Outline, 165-232, London
- BUTLER J J
 1963 Bronze Age Connections across the North Sea, Palaeohistoria IX
- CARPENTER R
 1958 Phoenicians in the west, AJA 62, 35ff
 1966 Beyond the Pillars of Hercules, London
- CARRIAZO J de M
 1947 La edad del bronce in MENENDEZ PIDAL R ed. Historia de España T. I, Vol. I, VI, 755-852, Madrid
 1970a El tesoro y las primeras excavaciones en "El Carambolo" (Camas, Sevilla), Exc. Arq. en España 68, Madrid
 1970b El tesoro y las primeras excavaciones de Ébora (Sanlúcar de Barrameda) Exc. Arq. en España 69, Madrid
 1973 Tartessos y el Carambolo, Madrid
- CARRIAZO J de M and RADDATZ K
 1961 Ergebnisse einer ersten stratigraphischen Untersuchung in Carmona, MM 2, 71-106
- DEL CASTILLO LOPEZ A
 1927 Hachas de bronce de talón, Boletín de la Real Academia Gallega La Coruña
- CATLING H
 1966 Cyprus in the late bronze age, CAH² II, Ch. XXII (b)
 1973 A pendent semicircle skyphos from Cyprus and a Cypriot imitation, Report of the Dept. of Antiquities, 179-85
 1975 Archaeology in Greece, 1974-75, Archaeological Reports, 21, 3-28
- CHAPMAN S V
 1972 A catalogue of Iron Age pottery from the cemeteries of Khirbet Silm, Joya, Qrayé and Qasmieh of South Lebanon, Berytus XXI, 55-194
- CHECKLAND S G
 1967 The Mines of Tharsis, London

- CHEHAB M
- 1968 Relations entre l'Égypte et la Phénicie des origines à Oun-Amon. in WARD W A ed. The role of the Phoenicians in the Interaction of Mediterranean Civilizations, (1967), 1-8, Beirut
- CINTAS P
- 1950 Céramique Punique, Paris
- 1970 Manuel d'Archéologie Punique, Paris
- COGAN M
- 1973 Tyre and Tiglath-Pileser III, JCS XXV, 96-9
- COLDSTREAM J N
- 1968 Greek Geometric Pottery, London
- 1969 The Phoenicians of Ialysos, Bull. Inst. of Class. Studies 16, 1ff
- 1971 The Cesnola Painter: a change of address, Bull. Inst. Class. Studies 18, 1-15
- COLES J
- 1962 European Bronze Age shields, PPS XXVIII, 156-190
- CONTENAU G
- 1949 La civilisation phénicienne, Paris
- COOK R M
- 1946 Ionia and Greece in the eighth and seventh centuries B.C., JHS LXVI, 67-98
- 1962 Reasons for the foundation of Ischia and Cumae, Historia XI, 113-14
- COOKE S R B and ASCHENBRENNER S
- 1975 The occurrence of metallic iron in ancient copper, Journal of Field Archaeology 2, 251-66
- CORREIA VERGÍLIO
- 1925a Um amuleto egípcio da necrópole de Alcácer do Sal, Terra Portuguesa 5, 41, 90-93
- 1925b Fechos de cinturão da necrópole de Alcácer do Sal, Biblos 1, 6, 319-26
- 1925c Uma conferencia sobre a necrópole de Alcácer do Sal, Biblos 1, 7, 347-63
- 1928 Escavações realizadas na necrópole pre-romana de Alcácer do Sal em 1926 e 1927, O Instituto 75, 190-201
- 1930 As fibulas da necrópole de Alcácer do Sal, Biblos 6, 7-9, 504-09
- 1972 Obras, Acta Universitatis Conimbrigensis IV, Coimbra
- COWEN J D
- 1955 Einführung in die Geschichte der bronzenen Griffzungenschwerter in Süddeutschland, BRGK 36, 52-155
- 1967 The Hallstatt sword-of-bronze: on the continent and in Britain, PPS XXXIII, 377-454

- DA COSTA J M
 1966 O tesouro fenício ou cartaginês do Gaio (Sines), Ethnos V, 529ff
- COSTA ARTHUR M^a de L
 1952 Necrópolis de Alcácer-do-Sal, II CNA, 369-380, Zaragoza
 1956 Máscara de Alcácer-do-Sal, Archivo Esp. de Arq. XXIX, 105-17
- CRADDOCK P T
 1977 The composition of bronze in the Iberian bronze age in Symposium on Early Extractive Metallurgy, British Museum 1977, (in press)
- CUADRADO E
 1961 Broches de cinturón de placa romboidal en la Edad del Hierro peninsular, Zephyrus 12, 208-20
 1963 Precedentes y prototipos de la fíbula anular hispánica, Trab. de Preh. VII, Madrid
 1966 Repertorio de los recipientes rituales metálicos con "Asas de manos" de la península ibérica, Trab. de Preh. XXI, Madrid
 1969 Orígen y desarrollo de la cerámica de barniz rojo en el mundo tartésico, V SIPP, 257-90, Barcelona
- CUADRADO DE ISASA F
 1970 Formas nuevas de la cerámica de barniz roja, XI CNA, 470-76, Zaragoza
- CULICAN W
 1958 Essay on a Phoenician ear-ring, PEQ July.-Dec., 100ff
 1961 Aspects of Phoenician settlement in the West Mediterranean, Abr Nahrain I (1959-60), 36ff
 1962 Melqart representations on Phoenician seals, Abr Nahrain II (1960-61), 41ff
 1966 The first Merchant Venturers, London
 1968a The iconography of some Phoenician seals and seal impressions, Australian Journal of Biblical Archaeology I, no. 1, 50-103
 1968b Quelques aperçus sur les ateliers phéniciens, Syria XLV, 275-93
 1970a Problems of Phoenicio-Punic Iconography - A contribution, Australian Journal of Biblical Archaeology I, no. 3, 28-57
 1970b Phoenician oil bottles and tripod bowls, Berytus XIX, 5-18
 1970c Almuñécar, Assur and Phoenician penetration of the Western Mediterranean, Levant II, 28-36
 1970d Coupes à décor phénicien provenant d'Iran, Syria XLVII, 65ff
 1970-71 Handle-attachments from Nubia: A note, Zephyrus XXI-XXII, 309-13
 1972 Phoenician remains from Gibraltar, Australian Journal of Biblical Archaeology II, no. 1, 110-45
 1973a Phoenician jewellery in New York and Copenhagen, Berytus XXII, 31-52
 1973b The graves at Tell er-Reqeish, Australian Journal of Biblical Archaeology II, no. 2, 66-105

- DANIEL G and EVANS J D
 1967 The Western Mediterranean, CAH² II, Ch. XXXVII
- DAVIES G
 1935 Roman Mines in Europe, Oxford
- DAYET M
 1967 Recherches archéologiques au "Camp du Château" (Salins) (1955-1959)
Revue Arch. de l'Est et du Centre-Est XVIII, 52-97
- DEMARGNE P
 1951 La céramique punique, Revue Archéologique 38, 44-52
- DEHN W
 1952 Die Ausgrabungen auf der Heuneburg beim Talhof (Donau) 1951/1952,
Germania 30, 325-29
 1957 Die Heuneburg beim Talhof unweit Riedlingen (Kr. Saulgau), FbS N.F. 14
 78-138
 1958 Die Heuneburg an der oberen Donau und ihre Wehranlagen in KRÄMER W
 ed. Neue Ausgrabungen in Deutschland, 127-45, Berlin
 1965 Die Bronzeschlüssel aus dem Hohmichele, Grab VI, und ihr Verwandten-
 kreis, FbS N.F. 17, 126-34
 1971 Hohmichele Grab 6 - Hradenin Grab 28 - Vace (Watsch) Helmgrab (Ein
 Nachtrag zu den späthallstattischen Bronzeschlüsseln), FbS N.F. 19,
 82-88
 1974 Einige Bemerkungen zum eisenzeitlichen Befestigungswesen in Mittel-
 europa in Symposium zu Problemen der jüngeren Hallstattzeit in Mittel-
europa (Nitra, 1970), 125-26, Bratislava
- DEHN W, SANGMEISTER E and KIMMIG W
 1954 Die Heuneburg beim Talhof. Vorläufige Ergebnisse der Grabungen
 1950-1953, Germania 32, 22-59
- DEHN W and FREY O-H
 1962 Die absolute Chronologie der Hallstatt- und Frühlatenezeit Mittel-
 europas auf Grund des Südimports, Atti del VI Congresso Internazio-
ale delle Scienze Preistoriche e Protostoriche
 197-208, Rome
- DESBOROUGH V R d'A
 1965 The Greek mainland, c. 1150-c.1000 B.C., PPS XXXI, 213-28
 1972 The Greek Dark Ages, London
- DESCOEUDRES J-P
 1968 Ausgewählte etruskische Keramik aus dem siebten und sechsten Jahr-
 hundert v. Chr., Antike Kunst 11, 102-05
- DIAKONOFF I M
 1969 Main features of the economy in the monarchies of Ancient Western
 Asia, Troisième conférence internationale d'histoire économique
 (Munich 1965), 13-32, Paris

- DOMERGUE C and FREIRE D'ANDRADE R
 1971 Sondages 1967 et 1969 à Aljustrel (Portugal). Note Préliminaire, Conimbriga X, 1-18
- DOTHAN T and BEN-TOR A
 1974 Excavations at Athienou 1971-72, Jerusalem.
- DROOP J P
 1925 Excavations at Niebla, Annals of Archaeology and Anthropology XII, 178ff
 1926 Excavations at Niebla, Annals of Archaeology and Anthropology XIII, 39
- DROWER M S
 1968 Ugarit, CAH² II, Ch. XXI(b)
 1969 Syria c. 1550-1400 B.C., CAH² II, Ch. X, part 2
 1970 Syria c. 1550-1400 B.C., CAH² II, Ch. X, part 1
- DUBY G
 1968 Rural Economy and Country Life in the Medieval West, London
 1974 The Early Growth of the European Economy, London
- DUNBABIN T J
 1948 The Western Greeks, Oxford
 1957 The Greeks and their Eastern Neighbours, London
- DU PLAT TAYLOR J
 1959 The Cypriot and Syrian pottery from Al Mina, Syria, Iraq XXI, 62ff
- DUPRÉ G
 1972 Le commerce entre sociétés lignagères: les Nzabi dans la traite à la fin du XIX^e siècle (Gabon-Congo), Cahiers d'Etudes Africaines XII, 48, 616-658
- DUPRÉ G and REY P P
 1968 Réflexions sur la pertinence d'une théorie de l'histoire des échanges, Cahiers Internationaux de Sociologie 46, 133-62
- EHRENBERG V
 1972 The Greek State, London
 1973 From Solon to Socrates, London
- EHRET C
 1976 Linguistic evidence and its correlation with archaeology, World Archaeology 8, no. 1, 5-18
- EIROA J J
 1973-74 Sobre la edad del bronce en el noroeste de la península hispánica, Caesaraugusta 37-38, 25-123
- EKHOLM K
 1972 Power and Prestige: the rise and fall of the Kongo Kingdom, Uppsala

- ENGEL A and PARIS P
 1906 Une forteresse ibérique à Osuna (Fouilles de 1903), Paris
- ESTEVE GUERRERO M
 1942 Las excavaciones de Asta Regia, AEArq 15, 245-47
 1945 Excavaciones de Asta Regia (Mesas de Asta, Jerez) Campaña de 1942-43, Acta Arqueológica Hispánica III, Madrid
 1969 Asta Regia: una ciudad tartésica, V SIPP, 111-18, Barcelona
- EVANS J D
 1952 Algunas espadas de tipo oeste Europeo en el Bronce II Español, II CNA, 181-84, Zaragoza
 1958 Two phases of prehistoric settlement in the Western Mediterranean, Annual Report of the Institute of Archaeology 13, (1955-56), 49-70
- FARINHA DOS SANTOS M
 1972 Pré-história de Portugal, Lisbon
- FERNÁNDEZ DE AVILÉS A
 1958 Vaso oriental de Torre del Mar (Málaga), Arqueología e Historia 8, 39-42
- FERNÁNDEZ CANIVELL R, SCHUBART H and NIEMEYER H G
 1967 Las tumbas de cámara 2 y 3 de Trayamar en Algarrobo (Málaga), Zephyrus 18, 63-77
- FERNÁNDEZ-CHICARRO C
 1947 La colección de marfiles, producto del comercio fenicio o púnico, del Museo Arqueológico Provincial de Sevilla, AEArq 20, 220-24
- FERNÁNDEZ-GOMEZ J H
 1973 Nuevo depósito de hachas de bronce descubierto en la isla de Formentera (Baleares), Pyrenae 9, 177-83
 1974 Hachas de bronce halladas en Ibiza y Formentera, VI SPP, 63-71, Barcelona
- FERNÁNDEZ MIRANDA M
 1975 Cabezo de El Castillo o de San Pedro y problemas del poblamiento de la actual ciudad de Huelva durante el primer milenio in ALMAGRO M et al Huelva: prehistoria y antigüedad, 221ff, Madrid
- FÉVRIER J G
 1950 La marine phénicienne, La Nouvelle Clio II, no. 3, 128-43
- FINLEY M I
 1954 Marriage, sale and gift in the Homeric world, Seminar XII, 7-33
 1960 Was Greek civilization based on slave labour? in FINLEY M I ed. Slavery in Classical Antiquity, 146-64, Cambridge
 1962 The Black Sea and Danubian regions and the slave trade in antiquity, Klio 40, 51-59

- 1965 Technical innovation and economic progress in the ancient world,
Economic History Review 18, 29-45
- 1968 The alienability of land in Ancient Greece: a point of view,
Eirene 7, 23-32
- 1970 Early Greece: the Bronze and Archaic Ages, London
- 1972 The World of Odysseus, Harmondsworth
- 1973 The Ancient Economy, London
- FISCHER F
- 1967 Alte und neue Funde der Latène-Zeit aus Württemberg, FbS N.F. 18, 1,
61-105
- FORRER E O
- 1953 Karthago wurde erst 673/663 gegründet in Festschrift Franz Dornsieff,
Leipzig
- FORREST W G
- 1957 Colonisation and the rise of Delphi, Historia 6, 160-75
- 1966 The Emergence of Greek Democracy, London
- FRAGOSO DE LIMA J
- 1960 Castro de Ratinhos (Moura, Baixo Alentejo, Portugal), Zephyrus II,
233-37
- FRANKENSTEIN S
- 1971 The Castro Culture of Galicia (Spain) and Northern Portugal,
B.A. dissertation, University of London
- FRENCH A
- 1964 The Growth of the Athenian Economy, London
- FREY O-H
- 1957 Die Zeitstellung des Fürstengrabes von Hatten im Elsass,
Germania 35, 236-49
- 1963 Zu den "rhodischen" Bronzekannen aus Hallstattgräbern, Marburger
Winkelmann-Programm
- FREYER-SCHAUENBURG B
- 1966 Kolaios und die Westphönizischen Elfenbeine, MM 7, 89-108
- FRÉZOULS E
- 1955 Une nouvelle hypothèse sur la fondation de Carthage,
Bulletin de Correspondance Hellénique 79, 153-76
- GAMER-WALLERT I
- 1973 La inscripción del vaso de alabastro de la tumba num. 1, de
Almuñécar (Granada), XII CNA, 401ff, Zaragoza
- 1975 Der Skarabäus des Pedubaste von der Finca de Jardín, MM 16, 187-94
- GARBINI G
- 1966 I Fenici in Occidente, Studi Etruschi XXXIV, 166ff

GARCÍA Y BELLIDO A

- 1934 Factores que contribuyeron a la Helenización de la España prerromana, Madrid
- 1942 Fenicios y cartagineses en occidente, Consejo Superior de Investigaciones Científicas, Escuela de Estudios Hebraicos, Madrid
- 1944 Tartessos pudo estar donde ahora la isle de Saltés en el estuario de Huelva, AEArq. 18, 191-95
- 1952 El mundo de las colonizaciones in MENENDEZ PIDAL R ed. Historia de Espana T. I, vol. II, Madrid
- 1953 La Península Ibérica en los comienzos de su historia, Madrid
- 1956 Materiales de arqueología hispano-púnica. Jarros de bronce, AEArq. 29, 85-104
- 1960 Inventario de los jarros púnicos tartésicos, AEArq. 33, 44ff
- 1964 Nuevos jarros de bronce tartessios, AEArq. 37, 50-80
- 1966 Nuevo jarro hispano-púnico de bronce, AEArq. 39, 143-44
- 1970 Algunas novedades sobre la arqueología púnico-tartessia, AEArq. 43, 3-49
- 1971 Iberische Kunst in Spanien, Mainz

GARCÍA Y BELLIDO A, SCHUBART H and NIEMEYER H G

- 1971 Espagne in L'Espansione fenicia nel Mediterraneo, Studi Semitici 38, 145ff

GARCÍA SÁNCHEZ M

- 1963 El poblado argárico del Cerro del Culantrillo, en Gorafe (Granada) Archivo de prehistoria levantina X

GARRIDO ROIZ J P

- 1968 Excavaciones en Huelva. El Cabezo de la Esperanza. Exc. Arq. en España 63, Madrid
- 1970 Excavaciones en la necropolis de "La Joya" Huelva (1^a y 2^a campañas) Exc. Arq. en España 71, Madrid
- 1971 Los poblados del Bronce I hispánico del estuario del Tinto-Odiel y la secuencia cultural megalítica en la región de Huelva, Trab. de Preh. 28, 93ff
- 1973 Las nuevas campañas de excavaciones arqueológicas en la necrópolis orientalizante de la Joya en Huelva, XII CNA, 395-400, Zaragoza
- 1975 Poblados de la edad del bronce y otros elementos culturales in ALMAGRO M et al Huelva: prehistoria y antigüedad, 183ff, Madrid

GARRIDO ROIZ J P and ORTA E M

- 1966 Nueva hallazgo de una tumba de incineración en los cabezos de Huelva. Ampurias 28, 209-15
- 1975 Edad del Hierro in ALMAGRO M et al Huelva: prehistoria y antigüedad, 195-211, Madrid

- GERSBACH E
- 1969 Heuneburg - Aussensiedlung - jüngere Adelsnekropole in FREY O-H ed. Marburger Beiträge zur Archäologie der Kelten, Fundberichte aus Hessen, Beiheft 1, 29-34, Bonn
- 1973 Die mittelbronzezeitlichen Wehranlagen der Heuneburg bei Hunderringen a.d. Donau, Archäologisches Korrespondenzblatt 3, 417ff
- 1974 Vorläufige Ergebnisse der Ausgrabungen 1959-1969 auf der Heuneburg (Die Siedlungsstadien der Periode IV) in Symposium zu Problemen der jüngeren Hallstattzeit in Mitteleuropa (Nitra 1970), 189-204 Bratislava
- GLOCK A
- 1972 Taanach in Jezreel: A review. unpublished ms. River Forest Ill.
- GOESSLER P
- 1911 Die Altertümer des Oberamtes Blaubeuren, Stuttgart
- 1923 Die vor- und frühgeschichtliche Besiedlung des Oberamtes Riedlingen, Stuttgart
- GRAHAM A J
- 1964 Colony and Mother City in Ancient Greece, Manchester
- 1971 Patterns in early Greek colonisation, JHS XCI, 35-47
- GRAN AYMERICH J M J.
- 1973 Sondeos arqueológicos en "Cerca Niebla", sobre el valle del Río Vélez, Provincia de Málaga, XII CNA, 411ff, Zaragoza
- GRAN AYMERICH J M J, GRAN AYMERICH E and SAADE W
- 1975 Cerca Niebla - El Vado, 1972, NAH, Arqueología 3, 141-90
- GSELL S
- 1929 Histoire ancienne de l'Afrique du Nord, Paris (2nd ed.)
- GUIDO M
- 1963 Sardinia, London
- HAFFNER A
- 1976 Die westliche Hunsrück-Eifel-Kultur, Römisch-Germanische Forschungen 36, Berlin
- HALLO W W
- 1960 From Qarqar to Carchemish. Assyria and Israel in the light of new discoveries, Biblical Archaeologist XXIII, 2, 34ff
- HANKEY V
- 1967 Mycenaean pottery in the Middle East: notes on finds since 1951, BSA 62, 107-48
- 1974 A late bronze age temple at Amman, Levant 6, 131-78
- HARBISON P
- 1967 Mediterranean and Atlantic elements in the early bronze age of Northern Portugal and Galicia, MM 8, 100-22

- 1968 Tres tipos de machados de bronze do norte de Portugal e suas prováveis origens, Rev. de Guimarães 78, 49-54
- HARDEN D
- 1937 The pottery from the precinct of Tanit at Salammbô, Carthage, Iraq IV, 59-89
- 1948 The Phoenicians on the west coast of Africa, Antiquity XXII, 141-50
- 1971 The Phoenicians, Harmondsworth
- HARRISON R J, MARTÍ-JUSMET F and GIRÓ P
- 1974 Faience beads and Atlantic bronzes in Catalonia, MM 15, 77-94
- HARTMANN A
- 1970 Prähistorische Goldfunde aus Europa, Studien zu den Anfängen der Metallurgie, 4, Berlin
- HATT J-J
- 1956 Informations: Haut-Rhin, Gallia 14, 294-97
- HAWKES C F C
- 1952 Las relaciones en el bronce final entre la Península Ibérica y las Islas Británicas con respecto a Francia y la Europa Central y Mediterránea, Ampurias XIV, 81ff
- 1969 Las relaciones atlánticas del mundo tartésico, V SIPP, 185-98, Barcelona
- 1971 The Sintra gold collar, The British Museum Quarterly XXXV, 1-4, 38-50
- HAWKES C F C and SMITH M A
- 1957 On some buckets and cauldrons of the Bronze and Early Iron Ages, Antiq. Journal XXXVII, 131-98
- HENCKEN H
- 1950 Herzsprung shields and Greek trade, AJA 54, 295ff
- 1955 A Western razor in Sicily, PPS XXI, 160-62
- 1956 Carp's tongue swords in Spain, France and Italy, Zephyrus VII, 124-78
- 1958 Syracuse, Etruria and the North: some comparisons, AJA 62, 259-72
- 1968 Tarquinia, Villanovans and Early Etruscans, American School of Pre-historic Research, Bull. no. 23, Cambridge, Mass.
- HIGGINS R A
- 1969 Early Greek jewellery, BSA 64, 143ff
- HOOD S
- 1967 Buckelkeramik at Mycenae? in BRICE W C, ed. Europa, 120-131
- HUBENER W
- 1972 Die hallstattzeitliche Siedlung auf dem Kapf bei Villingen im Schwarzwald in SPINDLER K Magdalenenberg II, 51-88, Villingen

HUMPHRIES S C

- 1965 Il commercio in quanto motivo della colonizzazione greca dell'Italia e della Sicilia, Rivista Storica Italiana 77, 421-33
- 1966 Colonie e madre patria nella grecia antica, Rivista Storica Italiana 78, 912-21
- 1969 History, economics, and anthropology: the work of Karl Polanyi, History and Theory VIII, 2, 165-212

HUNDT - H-J

- 1969 "Über vorgeschichtliche Seidenfunde, Jb. RGZM 16, 59-72

ISSERLIN B S J, PARR P J and CULICAN W

- 1956 Excavations at Motya: a Phoenician colony in Sicily, Antiquity XXX, 110-13

ISSERLIN B S J, CULICAN W, BROWN W L and TUSA-CUTRONI A

- 1958 Motya 1955, PBSR XXVI, 1-29

ISSERLIN B S J et al

- 1970 Motya (Trapani) - Rapporto preliminare sugli scavi degli anni 1961-65, Not. Scav. XXIV, 560-83

ISSERLIN B S J, DU PLAT TAYLOR J et al

- 1974 Motya. A Phoenician and Carthaginian City in Sicily, Leiden

JANKUHN H

- 1969 Vor- und Frühgeschichte vom Neolithikum bis zur Völkerwanderungszeit, Deutsche Agrargeschichte I, Stuttgart

JEFFERY L H

- 1961 The local scripts of Archaic Greece, Oxford

JENSEN L B

- 1963 Royal purple of Tyre, JNES 22, 104ff

JODIN A

- 1966 Mogador, comptoir phénicien du Maroc atlantique, ETAM II, Tanger

JORDÁ CERDÁ F, GARCÍA DOMÍNGUEZ E and AGUADÉ J

- 1972-73 Notas sobre los Tumulos de Campiello. (Tineo) y su Edad Postdolmenica, Zephyrus XXIII-XXIV, 131-52

JULLY J J

- 1965 Le marché du metal en Méditerranée occidentale au Premier Age du Fer: Sémites et Etrusques, Opuscula Romana V, 27-61

- 1969 Céramiques anglo-armoricaines et céramiques puniques. Voie maritime punique de l'étain, X CNA, 280-87, Zaragoza

KAHIL L

- 1968 Céramique géométrique et subgéométrique d'Érétrie, Antike Kunst 11, 99-101

- KARAGEORGHIS V
- 1969 Salamis in Cyprus. Homeric, Hellenistic and Roman, London
- 1973 Kition: Mycenaean and Phoenician, Proc. of the British Academy LIX
- 1974 La necrópolis de Salamina, Trab. de Preh. 31, 217-28
- KARAGEORGHIS V and KAHIL L
- 1967 Temoignages Eubéens à Chypre et Chypríotes à Erétrie, Antike Kunst 10, 133-35
- KATZENSTEIN H J
- 1973 The History of Tyre, Jerusalem
- KELLER J
- 1965 Das keltische Fürstengrab von Reinheim, Komm. für Saarländische Landesgeschichte, Band 1, Mainz
- KENYON K
- 1971 Palestine in the time of the 18th Dynasty, CAH² Vol. II, Ch. XI
- KIMMIG W
- 1965 Der Krieger von Hirschlanden, VIII^e Congres Internat. d'Arch. Classique (Paris 1963), 94ff, Paris
- 1968 Die Heuneburg an der oberen Donau, Führer zu vor- und frühgeschichtlichen Denkmälern in Württemberg und Hohenzollern, Heft 1, Tübingen
- 1969 Zum Problem späthallstädtischer Adelssitze in Siedlung, Burg und Stadt, Festschrift P. Grimm. Dt. Akad. der Wissenschaft, Berlin, Vor- und Frühgeschichte 25, 95-113
- 1975 Early Celts on the upper Danube: the excavations at the Heuneburg in BRUCE-MITFORD R ed. Recent archaeological excavations in Europe, London
- KIMMIG W and REST W
- 1954 Ein Fürstengrab der späten Hallstattzeit von Kappel am Rhein, Jb. RGZM 1, 179-216
- KIMMIG W and GERSBACH E
- 1966 Die neuen Ausgrabungen auf der Heuneburg, Germania 44, 102-36
- 1971 Die Grabungen auf der Heuneburg, 1966-1969, Germania 49, 21-91
- KIMMIG W and VON VACANO O-W
- 1973 Zu einem Gussform-Fragment einer etruskischen Bronzekanne von der Heuneburg an der oberen Donau, Germania 51, 72-84
- KITCHEN K A
- 1973 The Third Intermediate Period in Egypt (1100-650 B.C.), Warminster
- KLEIN J
- 1972 A Greek metalworking quarter. Eighth century excavations on Ischia, Expedition 14, 2, 34-39
- KOSSACK G
- 1959 Südbayern während der Hallstattzeit, Römisch-Germanische Forschungen 20, Berlin

- KUKAHN E and BLANCO A
 1959 El tesoro de "El Carambolo"; AEArq: 32, 38-49
- KURTZ D C and BOARDMAN J
 1971 Greek Burial Customs, London
- LAMBERT W G
 1974 The reigns of Aššurnasirpal II and Shalmaneser III: an interpretation, Iraq XXXVI, 103ff
- LANG A
 1974 Die geriefte Drehscheibenkeramik der Heuneburg 1950-1970 und verwandte Gruppen, Heuneburgstudien III, Römisch-Germanische Forschungen Band 34, Berlin
- LARSEN M T
 1967 Old Assyrian Caravan Procedures, Istanbul
 1974 The Old Assyrian colonies in Anatolia, Journal of the American Oriental Society 94, 4, 468-75
- LECLANT J
 1968 Les relations entre l'Egypte et la Phénicie du voyage d'Ounamon à l'expédition d'Alexandre in WARD W A ed. The role of the Phoenicians in the interaction of Mediterranean civilizations (Beirut 1967). 9-31, Beirut
 1970 Fouilles et travaux en Egypte et au Soudan 1968-1969, Orientalia 39, 320-70
- LEEDS E T
 1930 A bronze cauldron from the River Cherwell, Oxfordshire, with notes on cauldrons and other bronze vessels of allied type, Archaeologia 80, 1-36
- LEPIKSAAR J
 1973 Fischknochenfunde aus der phönizischen Faktorei von Toscanos, Studien über frühe Tierknochenfunde von der Iberischen Halbinsel 4, 109-19
- LINDEMANN G
 1972 Westphoenikische Keramik des 7. und 6. Jahrhunderts. Die Entwicklung anhand importdatierter Grabzusammenhänge. Diss. Freiburg.
 1974 Phoenikische Grabformen des 7./6. Jahrhunderts v. Chr. im westlichen Mittelmeerraum, MM 15, 122-35
- LINDEMANN G, NIEMEYER H G and SCHUBART H
 1972 Toscanos, Jardín und Alarcón. Vorbericht über die Grabungskampagne 1971, MM 13, 125-57
- LLOYD A B
 1975 Were Necho's triremes Phoenician? JHS XVC, 45ff

- LÓPEZ CUEVILLAS F
- 1953 La Oestrimnida y sus relaciones marítimas, Cuadernos d'Estudios Galegos VIII, fasc. XXIV, 5-44
- 1955 Armas de bronce ofrendadas al río Sil, Zephyrus VI, 233-40
- LORIMER H L
- 1950 Homer and the Monuments, London
- LUZÓN J M
- 1962 Tartessos y la Ría de Huelva, Zephyrus XIII, 97-104
- LUZÓN J M and RUIZ MATA D
- 1973 Las raíces de Córdoba - Estratigrafía de la Colina de los Quemados, Real Academia de Córdoba
- MAASS-LINDEMANN G and SCHUBART H
- 1975 Jardín. Vorbericht über die Grabung 1974 in der Nekropole des 6./5. Jahrhunderts v. Chr., MM 16, 179-86
- MAC WHITE E
- 1951 Estudios sobre las relaciones atlánticas de la Península Hispánica en la Edad del Bronce, Publicaciones del Seminario de Historia Primitiva del Hombre, Disertaciones Matritenses 2, Madrid
- MAIER F
- 1962 Bemerkungen zu einigen späthallstattzeitlichen Armringen mit Schlangenkopfenden, FbS N.F. 16, 39-44
- MAISLER B (MAZAR)
- 1946 Canaan and the Canaanites, Bull. American School of Oriental Research 102, 7-12
- MALAMAT A
- 1963 Aspects of the foreign policies of David and Solomon, JNES XXII, no.1, 1ff
- MALUQUER DE MOTES J
- 1945-46 Las culturas hallstätticas en Cataluña, Ampurias VII-VIII, 115-84
- 1956 La técnica de incrustación del Boquique y la dualidad de tradiciones cerámicas en la Meseta durante la Edad del Hierro, Zephyrus VII, 179-215
- 1957 De metalurgia tartesia: el bronce Carriazo, Zephyrus VIII, 157-68
- 1960 Bases para el estudio de las culturas metalúrgicas en la Meseta, I SPP, 125-55, Pamplona
- 1963a El desarrollo de la primera Edad de Hierro, II SPP, 53-69, Barcelona
- 1963b Sobre la cerámica tartésica con decoración de retícula bruñida in Festschrift Bosch-Gimpera, 301-06, Mexico
- 1966 El impacto colonial griego y el comienzo de la vida urbana en Cataluña, Barcelona

- 1969a Los fenicios en Cataluña, V SIPP, 241-50, Barcelona
- 1969b Tartessos y su "historia", V SIPP, 389-406, Barcelona
- 1970a Late Bronze and Early Iron in the valley of the Ebro in
BOARDMAN J, BROWN M A and POWELL T G E eds. The European
Community in Later Prehistory. Studies in honour of C.F.C. Hawkes,
107-120, London
- 1970b Desarrollo de la orfebrería prerromana en la península ibérica,
Pyrenae 6, 79ff
- 1970c Tartessos. La ciudad sin historia, Barcelona
- MANSFELD G
- 1973 Die Fibeln der Heuneburg 1950-1970, Heuneburg studien II, Römisch-
Germanische Forschungen, Band 33, Berlin
- MARTÍNEZ SANTA-OLALLA J
- 1946a Esquema paleontológico de la península hispánica, Madrid
- 1946b La cerámica del bronce atlántico en el sudeste, II Congreso Arq. del
Sudeste Español, Albacete, 153 ff
- MASSON O and SZNYCER M
- 1972 Recherches sur les phéniciens à Chypre, Hautes Etudes Orientales 3,
Geneva/Paris
- MAUSS M
- 1954 The Gift, London
- MAXWELL-HYSLOP, K R
- 1956 Urartian bronzes in Etruscan tombs, Iraq XVIII, part 2, 150-67
- MEGAW A H S
- 1954 Archaeology in Cyprus, 1953, JHS LXXIV, 172ff
- MEILLASSOUX C
- 1960 Essai d'interprétation du phénomène économique dans les sociétés
traditionnelles d'auto-subsistance, Cahiers d'Etudes Africaines
I, 4, 38-67
- MÉLIDA J R
- 1921 Tesoro de Aliseda, Madrid
- MENDELSON I
- 1942 State slavery in ancient Palestine, Bull. American School of Orien-
tal Research 85, 14ff
- MESADO N
- 1974 Vinarragell (Burriana-Castellon), Valencia
- MEYER E
- 1931 Geschichte des Altertums, Stuttgart and Berlin

- MOLINA GONZÁLEZ F and PAREJA LÓPEZ E
- 1975 Excavaciones en la Cuesta del Negro (Purullena, Granada) Campaña de 1971, Exc. Arq. en España 86, Madrid
- MONTEAGUDO L
- 1951 Hachas de talón, Boletim do Grupo Alcaides de Faria III, no. 3, 1-10
- 1953 "Album gráfico de Carmona" por G. Bonsor, AEArq. 26, 356-62
- 1954 Metalurgia hispana de la edad del bronce, con especial estudio de Galicia y norte de Portugal, Publicaciones del Seminario de Arq. y Numismática Aragonesa 4, 55-95
- MOSCATI S
- 1968 The World of the Phoenicians, London
(page references here refer to paperback edition, 1973)
- MOSSE C
- 1970 La colonisation dans l'antiquité, Paris
- MOVERS F C
- 1856 Die Phönizier, II, Bonn
- MUHLY J D
- 1970 Homer and the Phoenicians, Berytus 19, 19ff
- 1973 Copper and tin. The distribution of mineral resources and the nature of the metals trade in the Bronze Age, Transactions of The Connecticut Academy of Arts and Sciences, New Haven, 43, 155-535
(reprinted: Archon Books, Hamden 1976)
- 1976 Supplement to Copper and tin, Transactions of The Connecticut Academy of Arts and Sciences, New Haven 46, 77-136
(reprinted with 'Copper and tin')
- NEGBI O
- 1971 Contacts between Byblos and Cyprus at the end of the third millenium B.C., Levant III, 98-109
- NEIMAN D
- 1965 Phoenician place-names, JNES XXIV, 113-15
- NIEMEYER H G
- 1970 Zum Thymiaterion vom Cerro del Peñón, MM 11, 96ff
- 1972 Orient im Occident - die Phöniker in Spanien. Ergebnisse der Grabungen in der archäologischen Zone von Torre del Mar (Málaga), MDOG 10, 5-44
- NIEMEYER H G, PELLICER CATALÁN M and SCHUBART H
- 1964 Altpunische Funde von der Mündung des río Algarrobo, MM 5, 73-90
- NIEMEYER H G and SCHUBART H
- 1965 Ein ostphönikisches Thymiaterion von Cerro del Peñón (Almayate Bajo, Prov. Málaga), MM 6, 74-83

- NIEMEYER H G, PELLICER CATALÁN M and SCHUBART H
 1966 La factoría paleopúnica en la desembocadura del río Algarrobo, IX CNA, 246ff, Zaragoza
- NIEMEYER H G and SCHUBART H
 1968a Toscanos und Trayamar, Grabungskampagne 1967, MM 9, 76ff
 1968b Untersuchungen zur altpúnischen Archäologie von Torre del Mar 1967, Archäologischer Anzeiger 344ff
 1969 Toscanos. Die altpúnische Faktorei an der Mündung des Rio de Velez. Lieferung 1: Grabungskampagne 1964, Madriders Forschungen 6, Berlin
 1972 Toscanos. Vorbericht über die Frühjahrskampagne 1971, Archäologischer Anzeiger, 226-37
 1975 Trayamar. Die Phönizischen Kammergräber und die Niederlassung an der Algarrobo-Mündung, Madriders Beiträge 4, Mainz
- NOUGAYROL J
 1956 Textes accadiens des archives sud, Mission de Ras Shamra IX, Paris
- OATES D
 1968 Studies in the Ancient History of Northern Iraq, London
- OATES J
 1959 Late Assyrian pottery from Fort Shalmanesar, Iraq XXI, 130-46
- OPPENHEIM A L
 1964 Ancient Mesopotamia, Chicago
 1967 Letters from Mesopotamia, Chicago
 1969a Comment, Troisième conférence internationale d'histoire économique (Munich 1965), 32ff, Paris
 1969b Essay on overland trade in the first millenium B.C., JCS 21 (1967), 236-54
- ORTA E M^a and GARRIDO J P
 1963 La tumba orientalizante de "La Joya", Huelva, Trab. de Preh. XI, Madrid
- PADRÓ I PARCERISA J
 1971 Breus notes sobre els escarabeus i escaraboids de la necropolis de Can Canyís, Pyrenae 7, 129ff
- PALLOTTINO M
 1975 The Etruscans, London
- PARET O
 1924 Fundberichte, FbS N.F. II (1922-24), 1-52
 1933-35a Fundberichte Hallstattzeit - Hallstattgräber bei Ebingen, FbS N.F. VIII, 70-3, 86
 1933-35b Fundberichte Hallstattzeit - Ein Fund aus dem Fürstengrabhügel Rauher Lehen bei Ertingen, FbS N.F. VIII, 73-75

- 1935 Das Fürstengrab der Hallstattzeit von Bad Cannstatt, FbS N.F. VIII, Anhang 1
- 1935-38 Fundberichte - Hallstattzeit. Weitere Hallstattgräber bei Ebingen, FbS N.F. IX, 47-50
- 1938-51 Das reiche Späthallstattzeitliche Grab von Schöckingen (Kr. Leonberg), FbS N.F. XII, 37-40
- 1961 Württemberg in vor- und frühgeschichtlicher Zeit, Stuttgart
- PARKE H W
- 1939 A History of the Delphic Oracle, Oxford
- PARKER B
- 1963 Economic tablets from the temple of Mamu at Balawat, Iraq XXV, 86ff
- PASCUAL GUASCH R
- 1969 Un nuevo tipo de anfora púnica, AEArq. 42, 12ff
- PELLICER CATALÁN M
- 1962 Excavaciones en la necrópolis púnica "Laurita" del Cerro de San Cristobal (Almuñécar, Granada), Exc. Arq. en España 17, Madrid
- 1963 Ein altpunisches Gräberfeld bei Almuñécar (Prov. Granada), MM 4, 9-38
- 1969 El yacimiento de los Toscanos y su contribución al estudio de las cerámicas pintadas hispanas protohistóricas, AEArq. 42, 3ff
- PELLICER CATALÁN M and SCHULE W
- 1966 El Cerro del Real (Galera, Granada), Exc. Arq. en España 52, Madrid
- PELTENBURG E J
- 1969 Al Mina glazed pottery and its relations, Levant I, 73ff
- PEMÁN C
- 1940-41 Sobre el casco griego del Guadalete, AEArq. 14, 407ff
- PERICOT L
- 1969 Schulten y Tartessos, V SIPP, 63-74, Barcelona
- PICARD G C and PICARD C
- 1968 The Life and Death of Carthage, London
- PINGEL V
- 1975a Zur Vorgeschichte von Niebla (Prov. Huelva), MM 16, 111-36
- 1975b Bemerkungen zu den Analysenergebnissen der Goldfunde von Trayamar in NIEMEYER H G and SCHUBART H Madriider Beiträge 4, 161-67, Mainz
- POLANYI K
- 1957 The economy as instituted process in POLANYI K, AHRENSBERG C M and PEARSON H W eds. Trade and Market in the Early Empires, New York/London
- PONSICH M
- 1969a Nouvel aspect de l'industrie préromaine en Tingitane, Bulletin Archéologique N.S. 4 (1968), 225-36

- 1969b Influences pheniciennes sur les populations rurales de la region de Tanger, V SIPP, 173-82, Barcelona
- 1971 L'implantation humaine dans le Tangerois, du Paléolithique à la période Romaine, Notes et M. Serv. geol. Maroc, no. 222 bis, 165-76
- 1974 Implantation rurale antique sur le Bas-Guadalquivir, Publications de la Casa de Velazquez, Serie "Archéologie" Fasc. II, Madrid
- POPHAM M R , and SACKETT L H
- 1968 Excavations at Lefkandi, Euboea, 1964-66, BSA publication
- PRAUSNITZ M
- 1966 A Phoenician krater from Achziv, Oriens Antiquus V, 2, 177ff
- PRITCHARD J B
- 1955 Ancient Near Eastern Texts, Princeton (2nd ed.)
- 1969 The Ancient Near East - Supplementary Texts and Pictures relating to the Old Testament, Princeton
- 1975 Sarepta. A Preliminary Report on the Iron Age, Museum Monographs, University Museum, University of Pennsylvania, Philadelphia
- RATHJE A
- 1976 A group of "Phoenician" faience anthropomorphic perfume flasks, Levant VIII, 96-99
- RAWLINSON G
- 1889 Phoenicia, New York
- REBUFFAT R
- 1966 Les Phéniciens à Rome, Mélanges d'archéologie et d'histoire, Ecole française de Rome LXXVIII, 7-48
- RENFREW C
- 1968 Wessex without Mycenae, BSA 63, 277ff
- REVERE R B
- 1957 'No man's coast': ports of trade in the Eastern Mediterranean in POLANYI K, AHRENSBERG C M and PEARSON H W eds. Trade and Market in the Early Empires, 38-63, New York/London
- RIDGWAY D
- 1967 "Coppa Cicladiche" da Veio, Studi Etruschi XXXV (Serie II), 311-21
- 1973 The first western Greeks: Campanian coasts and Southern Etruria in HAWKES C F C and HAWKES S eds. Greeks, Celts and Romans, 15-38, London
- 1974 Archaeology in Central Italy and Etruria, 1968-73, Archaeological Reports 20, 1973-74, 42ff
- RIDGWAY D and DICKINSON O T P K
- 1973 Pendent semicircles at Veii: a glimpse, BSA 68, 191-92

- RIEK G and HUNDT H J
 1962 Der Hohmichele. Ein Fürstengrabhügel der späten Hallstattzeit bei der Heuneburg. Römisch-Germanische Forschungen 25, Berlin
- RIIS P J
 1950 La estatuilla de alabastro de Galera, Cuadernos de Historia Primitiva V, 113-21
 1970 Sūkās I. The North-East Sanctuary and the First Settling of Greeks in Syria and Palestine, Sūkās; Publications of the Carlsberg expedition to Phoenicia I, Copenhagen
- RIVERO DE LA HIGUERA M^a C
 1972-73 Materiales inéditos de la cueva de Boquique. Datos para una nueva sistematización de la edad del bronce en Extremadura, Zephyrus XXIII-XXIV, 101-29
- ROCHA PEREIRA M H
 1962 Greek vases in Portugal, University of Coimbra
- ROCHNA O
 1962 Hallstattzeitlicher Lignit- und Gagatschmuck. Zur Verbreitung, Zeitstellung und Herkunft, FbS N.F. XVI, 44-83
- ROEBUCK C
 1959 Ionian Trade and Colonization, New York
- ROSTOVTZEFF M
 1932 Caravan Cities, 1932
- ROTHENBERG B
 1972 Timna. Valley of the Biblical Copper Mines, London
- ROWLANDS M J
 1976 The Production and Distribution of Metalwork in the Middle Bronze Age in Southern Britain, British Archaeological Reports 31
- RUIZ MATA D
 1975 Cerámicas del bronce del poblado de Valencina de la Concepción (Sevilla), MM 16, 80-95
- RUOFF U
 1974 Zur Frage der Kontinuität zwischen Bronze- und Eisenzeit in der Schweiz, Bern
- SACKETT L H et al
 1966 Prehistoric Euboea: Contributions toward a Survey, BSA 61, 33-112
- SACKETT L H and POPHAM M R
 1972 Lefkandi. A Euboean town of the Bronze Age and the Early Iron Age (2100-700 B.C.), Archaeology 25, 8-19
- SAHLINS M
 1963 Poor man, rich man, big-man, chief: political types in Melanesia and Polynesia, Comparative Studies in Society and History 5, 285-303

- 1968 Tribesmen, The Foundations of Modern Anthropology Series, Englewood Cliffs
- 1972 Stone Age Economics, Chicago
- SAIDAH R
- 1966 Fouilles de Khaldé. Rapport préliminaire sur la première et deuxième campagnes (1961-1962), Bulletin du Musée de Beyrouth XIX, 51-90
- 1969 Archaeology in the Lebanon, 1968-1969, Berytus XVIII, 119-42
- VON SALDERN A
- 1970 Other Mesopotamian glass vessels (1500-600 B.C.) in OPPENHEIM A L, BRILL R H, BARAG D, and VON SALDERN A, Glass and Glassmaking in Ancient Mesopotamia, 203ff, New York
- SÁNCHEZ MESEGUER J
- 1969 Las cerámicas del bronce final de Galera, Informes y Trabajos del Instituto Central de Conservación y Restauración 9, 79ff
- SANDERS N K
- 1957 Bronze Age Cultures in France, Cambridge
- 1971 Thirty seasons at Ras Shamra in Syria, Levant III, 139-46
- SANGMEISTER E
- 1964 Die Stellung des Grabhügelfeldes von Mauenheim in der westlichen Hallstattkultur, Hegau 9, 5ff.
- SANTA OLALLA - see MARTÍNEZ SANTA OLALLA
- DOS SANTOS ROCHA A
- 1897 As loucas pintadas do Castro de Santa Olaia, Memorias sobre a Antiguedade, 253-57, Figueira da Foz
- 1905-08 Estacoes pre-romanas da Idade do Ferro nas visinhanças da Figueira, Portugalia II, 301-359, 493-516
- 1908 O "tumulus" do monte de Ferrestello, Boletim da Sociedade Archeologica Santos Rocha, Tomo I, no. 7, 199-201
- 1909 O castro do Bizzorreiro de Castella, Boletim da Sociedade Archeologica Santos Rocha, Tomo I, no. 9, 245
- 1971 Memorias e Esploracoes Archeologicas, Vol. II, Estacoes pre-romanas da idade do ferro nas vizinhanças da Figueira Acta Universitatis Conimbrigensis, Coimbra
- SAVORY H N
- 1948 The 'Sword-bearers'. A reinterpretation, PPS XIV, 155ff
- 1949 The Atlantic Bronze Age in South-West Europe, PPS XV, 128-155
- 1958 The origin of British palstaves with double loops, Arqueologia e Historia, 8^e serie, VIII, 67-74
- 1968 Spain and Portugal. The prehistory of the Iberian Peninsula, London

- SCHAAFF U
 1969 Versuch einer regionalen Gliederung frühlatenezeitlicher Fürstengräber in FREY O-H ed. Marburger Beiträge zur Archäologie der Kelten, Fundberichte aus Hessen, Beiheft 1, 187-201, Bonn
- SCHAEFFER C F A
 1962 Ugaritica IV, Paris
- SCHIEK S
 1954 Das Hallstattgrab von Vilsingen, Festschrift P. Goessler, Tübinger Beiträge zur Vor- und Frühgeschichte 150ff, Stuttgart
 1956 Fürstengräber der jüngeren Hallstatt-Kultur in Südwestdeutschland, Dissertation Tübingen
- SCHIEK S
 1959 Vorbericht über die Ausgrabung des vierten Fürstenhügels bei der Heuneburg, Germania 37, 117ff
 1974 Zum Grafenbühl bei Asperg, Kreis Ludwigsburg, Fundberichte aus Baden-Württemberg 1, 321-5
- SCHUBART H
 1961 Atlantische Nietenkessel von der Pyrenäeanhalbinsel, MM 2, 35-54
 1964 Grabungen auf dem bronzezeitlichen Gräberfeld von Atalaia in Südpotugal, MM 5, 11-54
 1965 Atalaia, Arquivo de Beja XXII, 7-136
 1971a Acerca de la cerámica del Bronce Tardío en el sur y oeste peninsular, Trab. de Preh. 28, 3-32
 1971b O horizonte de Ferradeira, Revista de Guimarães LXXXI, 3-29
 1973a Archäologische Einleitung - Phönizische Niederlassungen an der spanischen Küste und ihre Beziehungen zum Hinterland, Studien über frühe Tierknochenfunde von der Iberischen Halbinsel 4, 1-8
 1973b Mediterrane Beziehungen der El Argar-Kultur, MM 14, 41-59
 1973c Tholos-Bauten von Colada de Monte Nuevo bei Olivenza (Prov. Badajoz), MM 14, 11-40
 1974 La cultura del Bronce en el sudoeste peninsular, Miscelanea Arqueologica, Tomo II, 345-70
 1975a Die Kultur der Bronzezeit im Südwesten der iberischen Halbinsel, Madridischer Forschungen 9, Berlin
 1975b Cronología relativa de la cerámica sepulcral en la cultura de El Argar, Trab. de Preh. 32, 79-92
 1976 Eine bronzezeitliche Kultur im Südwesten der iberischen Halbinsel, Dissertationes Archaeologicae Gandenses XVI, 221-34
- SCHUBART H and GARRIDO J P
 1967 Probegrabung auf dem Cabezo de la Esperanza in Huelva 1967, MM 8, 123f

- SCHUBART H, NIEMEYER H G and PELLICER CATALÁN M
 1969 Toscanos. La factoría paleopúnica en la desembocadura del río de Vélez. Escavaciones en 1964, Exc. Arq. en España 66, Madrid.
- SCHUBART H, NIEMEYER H G and LINDEMANN G
 1972 Toscanos, Jardín y Alarcón, NAH Arqueologia 1, 9-42
- "
 SCHULE W
 1961a. Vorformen von Fusszier und Armbrustkonstruktion der Hallstatt-D-Fibeln, MM 2, 55-69
 1961b Las mas antiguas fibulas con pie y ballesta, Trab. de Preh. II, Madrid
 1969a Die Meseta-Kulturen der Iberischen Halbinsel, Madrider Forschungen 3, Berlin
 1969b Tartessos y el hinterland, V SIPP, 15-32, Barcelona
- "
 SCHULE W and PELLICER CATALÁN M
 1966 El Cerro de la Virgen, Orce (Granada) I, Exc. Arq. en España 46, Madrid
- SCHULTEN A
 1955 Iberische Landeskunde, Strasbourg/Kehl
 1972 Tartessos, Madrid (1st publ. 1921)
- SCHWAPPACH F
 1973 Frühkeltisches Ornament zwischen Marne, Rhein und Moldau, Bonner Jb. 73, 53-111
- SCHWEITZER M R
 1970 Informations archéologiques. Circonscription d'Alsace: Illfurth, Gallia Préhistoire 13, 402ff
 1971 Decouverte de tessons attiques a figures noires au Britzgyberg pres d'Illfurth, Bull. du Musée Hist. Mulhouse 79, 39-44
 1973 Le Britzgyberg. Station du Hallstatt, Bull. du Musée Hist. Mulhouse 81, 43-64
- SEGURO PEREIRA F
 1965 Notícia sobre a estação arqueologica de Santa Olaia, Lucerna IV
- DE SERRA RAFOLS J
 1924 Els començos de la mineria i la metalurgia del coure a la Peninsula Iberica, Bulletí de l'Associació catalana d'Antropologia, Etnologia i Prehistoria, 147ff
- SIRET H and SIRET L
 1887 Les premiers ages du métal dans le sud-est de l'Espagne, Brussel
- SIRET L
 1907a Orientaux et Occidentaux en Espagne aux temps préhistoriques, Brussels
 1907b Villaricos y Herrerías, Madrid
 1913 Questions de Chronologie et d'Ethnographie Iberiques, Paris

SLICHER VAN BATH B H

1966 The Agrarian History of Western Europe: A.D. 500-1850, London

SMITH S S

1942 The Greek trade at Al Mina, Antiquaries Journal XXII, 87-112

SMITH W S

1965 Interconnections in the Ancient Near East, a Study of the Relationships between the Arts of Egypt, the Aegean, and Western Asia, New Haven

SMITHSON E L

1968 The tomb of a rich Athenian lady, ca. 850 B.C., Hesperia XXXVII, 77ff

SNODGRASS A

1964 Early Greek armour and weapons, from the end of the Bronze Age to 600 B.C., Edinburgh

1965 Barbarian Europe and Early Iron Age Greece, PPS XXXI, 229-40

1967 Arms and armour of the Greeks, London

1971 The Dark Age of Greece, Edinburgh

SOLER GARCÍA J M

1965 El tesoro de Villena, Exc. Arq. en España 36, Madrid

SPINDLER K

1971 Magdalenenberg I, Villingen

1972a Magdalenenberg II, Villingen

1972b Ein Gürtelhaken iberischer Herkunft vom Magdalenenberg bei Villingen im Schwarzwald, Archäologisches Korrespondenzblatt 2, 271ff

1972c Review article: ZURN H (1970) Hallstattforschungen ... Acta Præhistorica et Archaeologica 3, 227-30

1973 Magdalenenberg III, Villingen

1975 Zum Beginn der hallstattzeitlicher Besiedlung auf der Heuneburg, Archäologisches Korrespondenzblatt 5, 1, 41-46

STAHL-WEBER M

1972 Dix ans de Recherches Archéologiques Région de Mulhouse, Catalogue, Musée Historique Mulhouse.

STERN E

1976 Phoenician masks and pendants, PEQ 108, 109-18

STEWART J H

1972 Theory of Culture Change, Chicago

STONE J F S and THOMAS L C

1956 The use and distribution of faience in the Ancient East and Prehistoric Europe, PPS XXII, 37-84

STRATHERN A

1971 The Rope of Moka, Cambridge

- "
TÄCKHOLM U
1965 Tarsis, Tartessos und die Säulen des Herakles, Opuscula Romana V, 143-200
1969 El concepto de Tarsich en el Antiguo Testamento y sus problemas, V SIPP, 79-90, Barcelona
1975 Neue Studien zum Tarsis-Tartessos-problem, Opuscula Romana X, 41-57
- TARAMELLI A
1914 Il Tempio Nuragico, Roma
1921 Il ripostiglio di Monte Sa Idda. Decimoputzu (Cagliari), Monumenti Antichi XXVII, 6-107
- TARRADELL M
1952 Sobre el presente de la arqueología púnica, Zephyrus III, 151-74
1959 Lixus - Historia de la Ciudad, Tetuan
1960a El impacto colonial de los pueblos semitas, I SPP, 257-72, Pamplona
1960b Marruecos púnico, Tetuan
1962 El país valenciano del neolítico a la iberización, Valencia
1968 Economía de la colonización fenicia in TARRADELL M ed. Estudios de economía antigua de la Península Ibérica, Barcelona
- THOMAS C G
1970 A Mycenaean Hegemony? A reconsideration, JHS XC, 184ff
- THUREAU-DANGIN F
1934 Un comptoir de laine pourpre à Ugarit d'après une tablette de Ras-Shamra, Syria 15, 137ff
- TRÍAS DE ARRIBAS G
1967-68 Cerámicas griegas de la Península Ibérica, Valencia
- TRUMP D H
1972 Malta: An archaeological guide, London
- UENZE H P
1964 Zur Frühlatènezeit in der Oberpfalz, Bayerische Vorgeschichtsblätter 29, 77ff
- UERPMANN H-P and UERPMANN M
1973 Tierknochenfunde aus der phönizischen Faktorei von Toscanos und anderen phönizisch beeinflussten Fundorten der Provinz Malaga in Südspanien, Studien über frühe Tierknochenfunde von der Iberischen Halbinsel 4, 35-100
- UERPMANN M
1972 Archäologische Auswertung der Meeressmolluskenreste aus der westphönizischen Faktorei von Toscanos, MM 13, 164-71

- VAGNETTI L
 1970 I Micenei in Italia: La Documentazione Archeologica, La Parola del Passato, Rivista di Studi Antichi CXXXIV, 359-80
- VALLET G
 1958 Rhégion et Zancle, Paris
 1963 Métropoles et Colonies. Leurs rapports jusqu'à la fin du VI^e siècle, in Actes du 3^e congrès d'Etudes sur la grande Grèce, 209ff, Taranto
- VALLET G and VILLARD F
 1961 Céramique et histoire grecque, Revue Historique 225, 295-318
- VEECK W and GOESSLER P
 1927 Verzeichnis der Vor- und Frühgeschichtlichen Altertümer, Museum der Stadt Ulm, Ulm
- VERMEULE E T
 1960 The fall of the Mycenaean empire, Archaeology 13, 66-75
 1964 Greece in the Bronze Age, Chicago
- VIANA A
 1959 Notas históricas: I Castro de Nossa Senhora da Cola (Ourique), Arquivo de Beja XVI, 3-24
- VILÁ VALENTÍ J
 1968 La Península Ibérica, Barcelona
- VON DEN DRIESCH A
 1973 Nahrungsreste tierischer Herkunft aus einer tartessischen und einer spätbronzezeitlichen bis iberischen Siedlung in Südspanien, Studien über frühe Tierknochenfunde von der Iberischen Halbinsel 4, 9-31
- VOZA G
 1972 Thapsos. Primi risultati delle più recenti ricerche, Atti della XIV Riunione Scientifica dell'Istituto Italiano di Preistoria e Proto-
storia, 172-205, Florence
 1973 Thapsos: resoconto sulle campagne di scavo del 1970-71, Atti della XV Riunione Scientifica dell'Istituto Italiano di Preistoria e Proto-
storia, 133-57, Florence
- VUILLEMOT G
 1954 Fouilles puniques à Mersa Madakh (Département d'Oran), Libyca II, 299-342
 1955 La nécropole punique du phare dans l'île de Rachgoun (Oran), Libyca III, 7-62
- WAGNER E
 1911 Fundstätten und Funde aus vorgeschichtlicher, römischer und alaman-
nisch-frankischer Zeit im Grossherzogtum Baden. 2. Das badische
Unterland, Tübingen

- WALLACE W. . .
 1947 The demes of Eretria, Hesperia XVI, 115-46
- WALLERSTEIN I . . .
 1974 The Modern World-System, New York/London
- WAMSER L
 1972 Mauenheim und Bargaen - Zwei Grabhügelfelder der Hallstatt- und Frühlatenezeit aus dem nördlichen Hegau, Dissertation Freiburg i.Br.
- WARD W A
 1961 Egypt and the East Mediterranean in the Early Second Millenium B.C., Orientalia 30, 22-45, 120-155
 1963 Egypt and the East Mediterranean from Predynastic times to the end of the Old Kingdom, Journal of the Economic and Social History of the Orient VI, 1-58
- WARMINGTON B H
 1960 Carthage, London
- WEISGERBER G
 1975 " Agyptische Kupfergewinnung in Timna, Südisrael, Archäologisches Korrespondenzblatt 5, 35-40
- WHEELER T S, MADDIN R and MUHLY J D
 1975 Ingots and the Bronze Age copper trade in the Mediterranean: A progress report, Expedition 17, 4, 31-39
- WHITTAKER C R.
 1974 The Western Phoenicians: colonisation and assimilation, Proc. Cambridge Philological Society 200, 58-79
- WILL E
 1965 La Grece archaïque in FINLEY M I ed. Trade and Politics in the Ancient World, 2nd International Conference of Economic History, (Aix-en-Provence 1962), 41-96, Paris
- WINTER I J
 1971 The Carmona ivories and the Phoenicians in Spain, AJA 75, 217
 1973 North Syria in the early first millenium B.C., with special reference to ivory carving, Columbia University Ph.D.
 1976 Phoenician and North Syrian ivory carving in historical context: questions of style and distribution, Iraq XXXVIII, 1-22
- WOODHEAD A G
 1966 The Greeks in the West, London
- WOODHOUSE W J
 1938 Solon the Liberator, Oxford

- ZAMMIT T . . .
- 1927 Report on the working of the Museum Department for 1926-27, Malta
- 1928 Report on the working of the Museum Department for 1927-28, Malta
- ZURN H
- 1943 Zur Keramik der späten Hallstattzeit, Germania 27, 20ff
- 1952 " Zum Übergang von Späthallstatt zu Latène A im südwestdeutschen Raum, Germania 30, 38ff
- 1957 Zur Chronologie der Alb-Salem-Keramik, Germania 35, 224ff
- 1965 Grabungen beim und am Kleinaspergle auf Markung Asperg (Kr. Ludwigsburg), FbS N.F. 17, 194ff
- 1970 Hallstattforschungen in Nordwürttemberg, Veröffentlichung des Staatlichen Amtes für Denkmalpflege, Reihe A 16, Stuttgart
- ZURN H and HERRMANN H-V
- 1966 Der "Grafenbühl" auf der Markung Asperg, Kr. Ludwigsburg, ein Fürstengrabhügel der späten Hallstattzeit, Germania 44, 74-102

APPENDIX 1LATE BRONZE AGE/EARLY IRON AGE POTTERY FROM SITES IN THE
FIGUEIRA DA FOZ REGION (BEIRA LITORAL, PORTUGAL)

Plate No.	SITE	Catalogue No.	Location	Rim diameter cm	WARE description
2	SANTA OLAYA				FINE, HAND-MADE, BURNISHED
		6889	NW	18	grey-brown, fine filler
		F 1	NW	20	orange-brown, fine filler
		6926	NW	19	orange-brown, fine filler
		F 2	NW	21	orange-grey, fine filler
		F 3	NW	14	orange-grey, fine filler
		6886	NW	34	orange-brown, fine filler
		6875	NW	17	grey-brown, fine filler
		F 4	NW	17	orange-buff, quartz filler
		F 5	NW	20	grey-brown, quartz filler
		6902	NW	22	grey-buff, micaceous
		6903	NW	22	grey-yellow, fine filler
		6910	NW	23	buff-black, fine filler
		6907	-	23	grey-brown, calcareous filler
		F 6	NW	22	orange-brown-grey, calcareous filler
		6863	NW	18	orange-yellow, calcareous filler
		6887	NW	-	brown, calcareous filler
		8174	-	21	buff-brown, quartz and ?shell filler
		6890	NW	19	grey-brown, quartz and ?shell filler
		1588	NW	22	black-brown, calcareous filler, lug on rim
		6925	NW	24	brown, fine filler, lug on body
3	SANTA OLAYA	1696	-	25	grey-brown, large quartz filler
		1737	-	20	grey-brown, large quartz filler

APPENDIX 1 continued

Plate No.	SITE	Catalogue No.	Location	Rim diameter cm	WARE description
(3)	(SANTA OLAYA)				(FINE, HAND-MADE, BURNISHED)
		6921	NW	26	brown-black, calcareous filler
		F 7	NE	21	grey, micaceous, roughly burnished
		F 8	NE	22	buff-grey, large quartz filler, roughly burnished
		F 9	NW	30	orange-brown, fine filler
		6922	NW	19	grey-yellow, fine filler
		F 10	NW	-	black, scalloped rim, worn
		F 11	NW	24	black-grey, fine filler
		F 12	Settl.1	14	buff-grey
		6878	NY	21	black-buff
		F 13	NE	9	grey-yellow, micaceous
		F 14	NW	-	yellow, patchy, fine filler
		F 15	NW	-	yellow, patchy, fine filler, worn
		6904	NW	16	buff-brown, calcareous filler
4	SANTA OLAYA				COARSE, PLAIN
		6846	NW	34	buff, quartz filler, smoothed rim
		1659	NW	20	grey-brown, slightly smoothed
		6801	NW	13	brown-black
		2663	NW	11	grey, small rim piece only
		6802	NW	8	brown-black, quartz filler
		7781	NE	-	grey-brown, micaceous, quartz filler
		6810	NW	-	grey-brown, large quartz filler
		8255	NE	8	black-brown, mica and quartz filler, very roughly made
		8258	Casa y	12	brown-orange, very roughly made, smoothed surface
'5	SANTA OLAYA				COARSE, IMPRESSED OR SLASHED RIMS
		7777	-	15	grey-brown, quartz and ?shell filler, smoothed surface
		7778	-	17	grey-brown, quartz filler, smoothed surface

APPENDIX 1 continued

Plate No.	SITE	Catalogue No.	Location	Rim diameter cm	WARE description
(5)	(SANTA OLAYA)				(COARSE, IMPRESSED OR SLASHED RIMS)
		6860	-	20	grey, quartz filler
		8259	Casa y	12	brown-grey, very gritty
		6825	NE	16	orange-brown, quartz filler, rough surface
6	SANTA OLAYA	1687	-	28	buff-brown, large quartz filler, smoothed surface
		1654	-	27	brown, quartz filler, rough surface
		6814	NW	22	orange-buff, quartz filler
		1655	NW	30	grey, rough surface
		F 16	NW	25	brown-orange, quartz filler
		6813	-	16	buff-grey, quartz filler
		1987	NW	32	buff-grey, quartz filler, smoothed surface
		1687A	NW	36	pink-buff, quartz filler, rough, porous surface
		6871	-	31	pink-brown, large quartz filler, rough surface
		1734	-	29	orange-brown-buff, large quartz and ?shell filler, smoothed surface
7	SANTA OLAYA				COARSE, INCISIONS OR IMPRESSIONS ON BODY
		6856	NW	20	grey-brown, slightly smoothed
		6858	NW	-	brown body sherd
		6857	NW	-	brown, 'soapy' body sherd
					COARSE; SMALL HANDLED VESSELS
		6854	NW	-	buff, quartz filler, rough surface
		6855	NW	-	orange, micaceous, smooth surface
		1590	NW	-	grey-buff, quartz filler
8	SANTA OLAYA				RED SLIP, AND LOCAL IMITATIONS: PLATES OR BOWLS WITH BROAD RIMS AND EXTERNAL CARINATIONS
		7930	-	27	'soft', micaceous, colour well burnished, well made and fired: 10R 4/6 on 7.5YR 6/4

APPENDIX 1 continued

Plate No.	SITE	Catalogue No.	Location	Rim diameter cm	WARE description
(8)	(SANTA OLAYA)				(RED SLIP, AND LOCAL IMITATIONS: PLATES OR BOWLS WITH BROAD RIMS AND EXTERNAL CARINATIONS)
		F 17	NE	29	orange, with grey core: 1OR 4/4 on 5YR 7/6
		7924	-	-	well made: c.1OR 4/4 on 7.5YR 7/4
		1619	NE	30	orange-buff, with grey core: 7.5YR 4/6 on 5YR 7/4
		F 18	NE	-	'soft', well fired, 2.5YR 4/4 on 7.5YR 7/4
		F 19	-	31	buff orange, very micaceous, brown paint all over
		1540	-	27	very hard, fine orange, micaceous: no paint or burnishing
9	SANTA OLAYA	7949	NE	32.5	buff-orange ware: brown-violet to red paint (1OR 3/3 to 1OR 3/1) on 7.5YR 7/4
		7959	NE	29.5	buff-orange body: red-brown paint, c.OR 4/4 on 7.5YR 7/4
10	SANTA OLAYA				RED SLIP: 'PERFUME BURNERS'
		7932	-	29	orange with grey core: paint on outer plate applied on wheel, 1OR 3/4; paint on inner plate burnished in surviving better, 2.5YR 4/6, pm 5YR 6/6
		7931	-	-	inner bowl seen to be thrown into roughened interior base of outer bowl, paint very faded, c.1OR 4/8 on 7.5YR 8/4
		F 20	-	-	very small piece of double vessel, base diameter c.8cm: pale orange micaceous with grey core, very little paint surviving
11	SANTA OLAYA				RED SLIP DERIVED BOWLS, WITH FLAME AND STRIPED DECORATION
		F 21	NW	31	white 'flame' pattern on red background: c.1OR 4/4 on c.5YR 7/6
		7714	NE	31	ditto, 2.5YR 4/2 on 7.5YR 7/4

APPENDIX 1 continued

Plate No.	SITE	Catalogue No.	Location	Rim diameter cm	WARE description
(11)	(SANTA OLAYA)				RED SLIP DERIVED BOWLS, WITH FLAME AND STRIPED DECORATION
		F 22	NE	31	orange with grey core, slip is 2.5YR 4/4 on 7.5YR 7/4 with a dark stripe 2.5YR 2/4
		7717 (7950)	NW	30	cream 'flames' on traces of red slip, body colour is 7.5YR 7/4, micaceous ware
12	SANTA OLAYA				RED SLIP VESSELS: SOLID BASED FORMS
		8241	NE	13	thickly painted on inside, 7.5YR 4/4 burnished on 5YR 7/6
		F 23	NE	11	curious vessel: 2.5YR 4/2 on 10YR 8/4
					MISCELLANEOUS: 'NET WEIGHTS'
		1713	-	-	sherd of buff-orange micaceous ware, with traces of red-brown and white paint
		7983	-	-	thick orange micaceous body sherd
13	SANTA OLAYA				WHEEL-MADE, FINE WARE
		1755	Casa p	10	grey micaceous, quartz filler, very hard
		F 23	NE	14	very dark grey
		7789	NE	11	grey, micaceous, highly burnished on wheel
		7793	NE	10	ditto
		1639	NE	22	grey-buff
14	SANTA OLAYA				FINE WHEEL-MADE GREY WARE
		1568	-	24	dark grey exterior, lighter grey interior, well burnished rim, slightly micaceous
		1788	NE	23	ditto
		8119	NW	24	dark interior, light grey exterior, pre-firing incision on exterior
		8116	NW	27	ditto
		F 26	NE	-	grey base with incised marking

APPENDIX 1 continued

Plate No.	SITE	Catalogue No.	Location	Rim diameter cm	WARE description
15	(SANTA OLAYA)				(FINE WHEEL-MADE GREY WARE)
		8272	Casa y	33	micaceous, surface peeling, holes for suspension?
		8150	NE	36	grey ware, but with signs of oxidation during firing
		8148	NE	28	grey ware, well fired, 2 rectangular perforations
		4088	NE	25	burnished, white and micaceous filler, rim with incised decoration
16	SANTA OLAYA	7711	-	-	fine grey micaceous
		8161	-	-	very hard, fine micaceous, grey core but orange surface due to final oxidation during essentially reduction firing
		8151	-	-	fine grey micaceous
17	SANTA OLAYA	F 24	NE	28	bowl with beginning of handle which would go along and above rim
		6707	NE	26	burnished grey bowl, slightly micaceous, same handle as F 24
					GREY WARE RINGS AND WEIGHT
		8266	NE	14	highly burnished - by hand - wheel-made ring: probably a vase support
		F 25	NE	12	smaller, black matt surface, originally burnished, possibly hand-made
		7915	-	-	grey, hand-made rod, with single hole: probably a weight
18	SANTA OLAYA				WHEEL-MADE 'COARSE WARE'
		6898	NE	19	very gritty, patchy buff-and-black
		6877	NE	21	ditto
		F 27	Casa y	19	grey with black filler, horizontal burnishing
		7952	NE	-	grey micaceous body sherd, grooved and burnished decoration
		7749	NE	26	black, quartz filler, burnished in part, pattern is burnished

APPENDIX 1 continued

Plate No.	SITE	Catalogue No.	Location	Rim diameter cm	WARE description
(18)	(SANTA OLAYA)				(WHEEL-MADE 'COARSE WARE')
		7747	NE	-	brown micaceous, very worn, burnished decoration LATE IMPORTS: CAMPANIAN WARE
		7681	-	-	Campanian base, black 'varnish' on fine brown-pink, very worn
		F 28	-	-	black 'varnish' peeling off, grey, irregular base, with Campanian type decoration
19	SANTA OLAYA				WHEEL-MADE, PAINTED
		8995		20	fine orange-brown, slightly micaceous, fine grit, traces of paint
					WHEEL-MADE, GREY WARE
		1556		23	grey-buff, burnished on a wheel
20	SANTA OLAYA				PAINTED WARE (2-HANDLED STORAGE VESSELS)
		F 33		18	pink-brown with dark brown-red paint, in part c.10R 3/6, very worn
21	"	8323		21	fine orange-buff, with red 7.5R 4/6 and black 7.5R 2/2 paint on c.2.5YR 6/6
22	"	1551		19	pink-buff burnished, slightly micaceous, small grit, streaky bands of red paint 10R 4/6 on 5YR 7/4
23	"	F 30	NE	24	faintly micaceous, medium sized grit, faded white and red on body, c.10R 4/6 to 10R 6/6 on inside rim
24	"	1529		21	orange-buff, very hard, fine black grit (no paint survives)
25	"				'POLYCHROME' WARE
		8267	Casa y	21	fine orange-buff, slightly micaceous, fine grit, with red 10R 5/6 and black 10R 4/1 on c.2.5YR 6/6

APPENDIX 1 continued

Plate No.	SITE	Catalogue No.	Location	Rim diameter cm	WARE description
26	SANTA OLAYA				PAINTED WARE (STORAGE VESSEL)
		F 32		25	fine orange-buff, red-brown aint c.1OR 4/6 on c.2.5YR 6/4; hatching on white slip
27	"				PLAIN WARE (STORAGE VESSEL)
		6826	Casa m	19	grey-brown body, highly burnished, worn near base, which is reconstructed
28	"	F 29		30	same ware as 6826
29	"				PAINTED WARE (STORAGE VESSEL)
		1543		28	orange-buff, medium grit, with red 1OR 4/6 or 1OR 6/8 and white paint
30	"	1552		36	pale buff body, c.2.5YR 7/8 with cream and red paint, 7.5R 4/6 where well preserved
31	"				PLAIN WARE (STORAGE VESSEL)
		1680		24	buff-orange, grey in places, medium grit, surface possibly originally smoothed
32	"				HAND-MADE STORAGE VESSEL
		7914		c.58	brown-grey with dark polished surface, large filler including quartz and shell
33	"				PAINTED WARE: GLOBULAR VESSEL WITH HANDLES BETWEEN RIB ON NECK AND SHOULDER
		1563		15	orange-brown, slightly micaceous, small grit, very faded paint 1OR 5/8
34	"	260		14.5	orange-buff, fine mica and grit filler, paint c.7.5R 4/8 on 1OR 7/6
35	"				BAGGY-BODIED AMPHORA
		8080		16	pink-buff, originally with cream slip, fine grit
36	"	1811		15	buff, ?cream slip, slightly micaceous, fine grit

APPENDIX 1 continued

Plate No.	SITE	Catalogue No.	Location	Rim diameter cm	WARE description
37	SANTA OLAYA	7941		15	BAGGY-BODIED AMPHORA orange-buff, medium grit, traces of cream slip
38	"	F 31		17	COSTREL orange-brown, possibly originally with cream slip, calcareous inclusions (NO mica)
39	"	7623		16	POINTED-BODIED AMPHORA pink-brown-buff, sand filler (base reconstructed)
40	CHÔES	2623	-	13	FINE, HAND-MADE buff-brown-grey, burnished
		2621	-	20	grey-brown, mica and ?shell filler, burnished
		2564	-	-	FINE, WHEEL-MADE WARE orange micaceous, 'soft', traces of red paint on interior, ie. probably a red slip bowl, very worn
		2566	-	35	ditto but without paint
		2567	-	34	grey exterior, section brown-buff, quartz and grog filler, surface peels off
41	CHÔES	2282	-	13	HAND-MADE COARSE WARE brown-orange, 'soft', slashed/impressed decoration on rim, handle of 3 parts
		2277	-	-	brown sherd with stamped decoration, quartz filler
		2596	-	21	brown-orange, quartz and a little mica filler, rim with regular shallow impressions
		6376	-	28	red-brown, 'porous', impressed rim
		2597	-	24	brown, gritty, quartz filler, shallow impressions on rim
		2598	-	26	brown-grey, 'soft', shallow impressions on rim
		2358	-	25	orange, large mica filler, gritty, incised decoration

APPENDIX 1 continued

Plate No.	SITE	Catalogue No.	Location	Rim diameter cm	WARE description
42	CRASTO				FINE, HAND-MADE WARE
		2320	-	26	brown-orange, quartz and calcareous filler
		2300C	-	25	grey-brown, irregular thickness, ?shell filler, originally burnished
		2378A	-	30	orange-buff, quartz filler, smoothed surface
		2405A	-	35	black-brown, sand filler, burnished, but worn
		2405	-	29	buff-black, sand filler, burnished, but worn
		2405B	-	28	grey-brown, micaceous
		6924	-	11	black, micaceous, burnished, possibly with omphalos base
		2633	-	-	fine buff-grey, micaceous, burnished
		2300H	-	-	part of foot of pedestal bowl, brown-grey, burnished
43	CRASTO	2428	-	14	buff-orange, very worn, 'soft'
		8308	-	16	buff-grey, sandy, mica and quartz filler, burnished
		C 1	-	14	grey-brown, micaceous, burnished rim
		2432	-	16	buff-grey, sandy, mica and quartz filler, burnished
44	CRASTO				COARSE WARE (STORAGE VESSEL)
		2300F	-	23	brown-grey, quartz and possibly grog filler
		6960	-	17	grey-buff, sandy, large mica inclusions and quartz
		2294	-	24	brown-red, 'porous' surface, some quartz filler
		2293	-	22	brown-grey, quartz filler, irregular surface
		2321	-	31	orange-brown, 'porous', quartz filler
		2300	-	34	grey-brown, micaceous, very hard, some burnishing

APPENDIX 1 continued

Plate No.	SITE	Catalogue No.	Location	Rim diameter dm	WARE description
(44)	(CRASTO)				(COARSE WARE: STORAGE VESSELS)
		2297	-	19	brown, quartz filler, 'porous' texture
		2289	-	23	brown-grey, quartz filler, 'porous', rim smoothed
		7312	-	13	brown-orange, quartz and calcareous filler
		2404	-	12	grey-buff, sandy, mica and quartz in filler, rough surface
45	CRASTO				COARSE WARE: SMALL VESSELS
		6938	-	10	brown-grey, mica and some quartz, rough surface
		1912	-	13	orange-buff, very 'porous' surface
		5704	-	13	brown-black, very roughly made, some coils visible
					WHEEL-MADE FINE WARE
		4137	-	17	brown-buff, micaceous
46	CRASTO				WHEEL-MADE 'GREY WARE'
		4130	-	24	light grey, slightly micaceous
		4128	-	25	grey-buff body with easily removed grey surface, poorly wheel-made, very micaceous
		4122	-	29	very micaceous grey, 3 mending holes
		7592	-	30	buff bowl, very worn surface, flaking off, slightly micaceous, quartz filler
47	CRASTO				COARSE WARES, WITH SOME DECORATION: INCISED, IMPRESSED OR STAMPED
		7670	-	25	grey-buff, shallow finger impressions on neck, large mica and other filler
		2291	-	15	brown-grey, quartz filler, rough surface, small impressions on neck
		2278	-	-	body sherd, brown with soft ?calcareous filler, some mica, stamped and impressed decoration

APPENDIX 1 continued

Plate No.	SITE	Catalogue No.	Location	Rim diameter cm	WARE description
(47)	(CRASTO)				(COARSE WARES, WITH SOME DECORATION: INCISED, IMPRESSED OR STAMPED)
		1923	-	-	grey-buff, quartz filler, 'porous' surface, slashed rim
		2336A	-	29	red-brown, some ?shell filler, incisions on rim
		2300E	-	15	buff and grey, quartz filler, shallow slashes on rim
48	CRASTO				WHEEL-MADE FINE WARE
		2397D	-	13	grey-buff, micaceous
		7616	-	13	ditto
		2338	-	20	ditto
					WHEEL OR HAND-MADE 'COARSE WARE' (STORAGE VESSELS)
		2415	-	23	grey, gritty, probably wheel-made
		2366	-	30	grey-buff, large quartz, ?shell and mica filler, hand-made
		2397	-	22	grey-brown, filler as 2366, hand-made
		2463	-	15	orange, mica and quartz filler, very worn, wheel-made
		2431	-	29	orange, very micaceous and gritty, probably wheel-made
		2430	-	36	grey-buff, ware like 2431, probably wheel-made

Colours: 'Munsell Soil Color Chart'



Plate 1: The Outeiro of SANTA OLAYA viewed from the west.

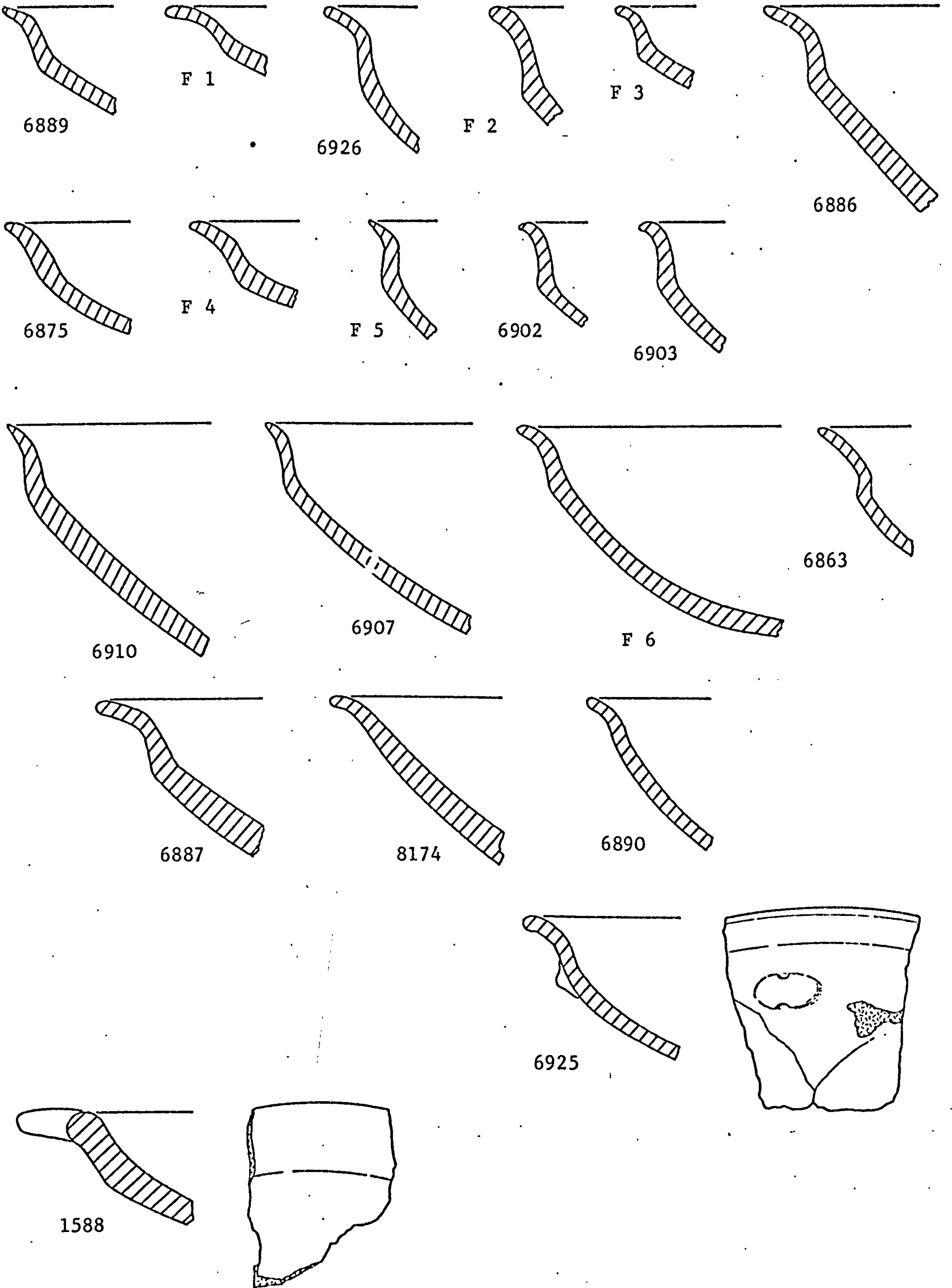
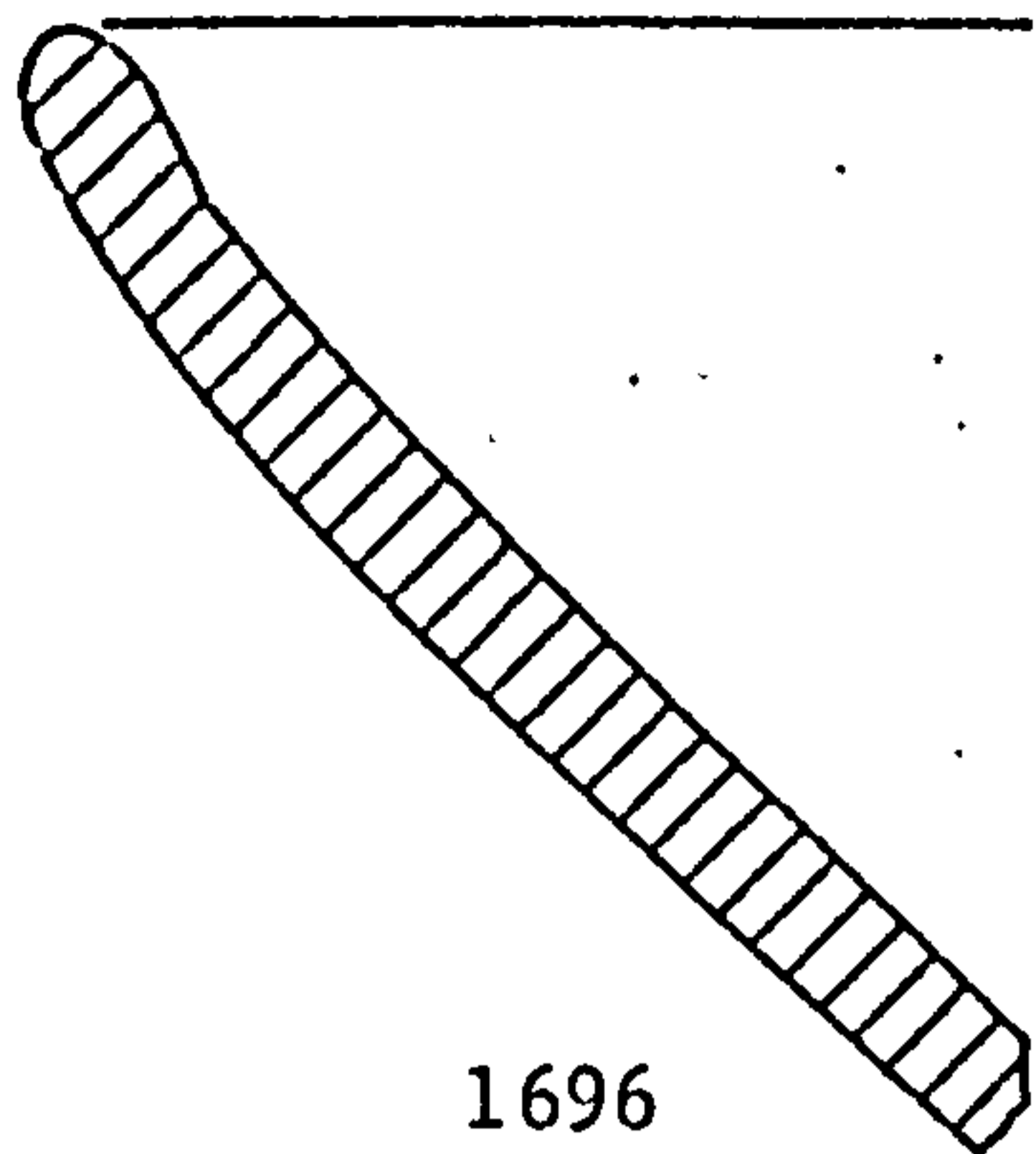
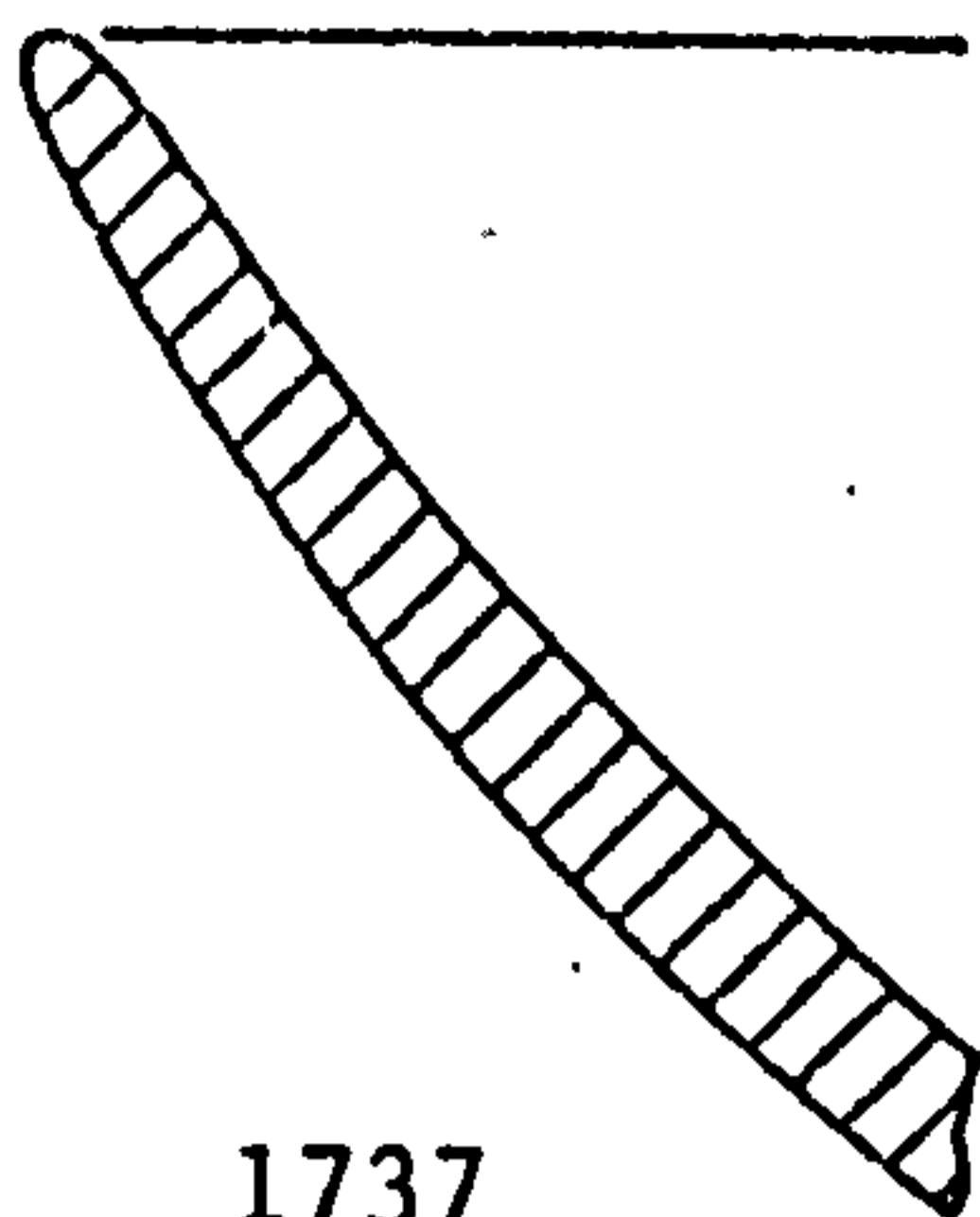

Plate 2: SANTA OLAYA

0 10 cm



1696



1737

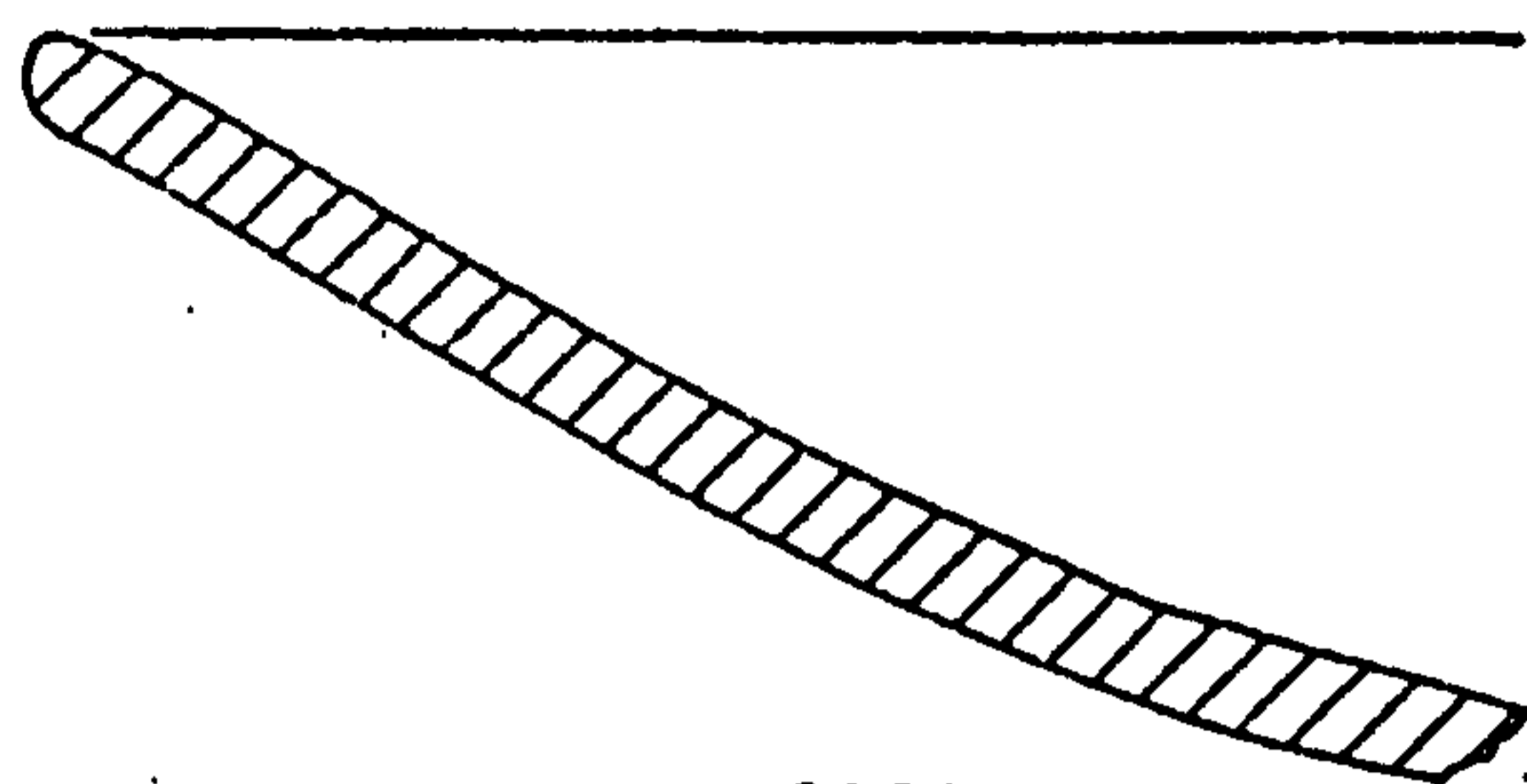

6921

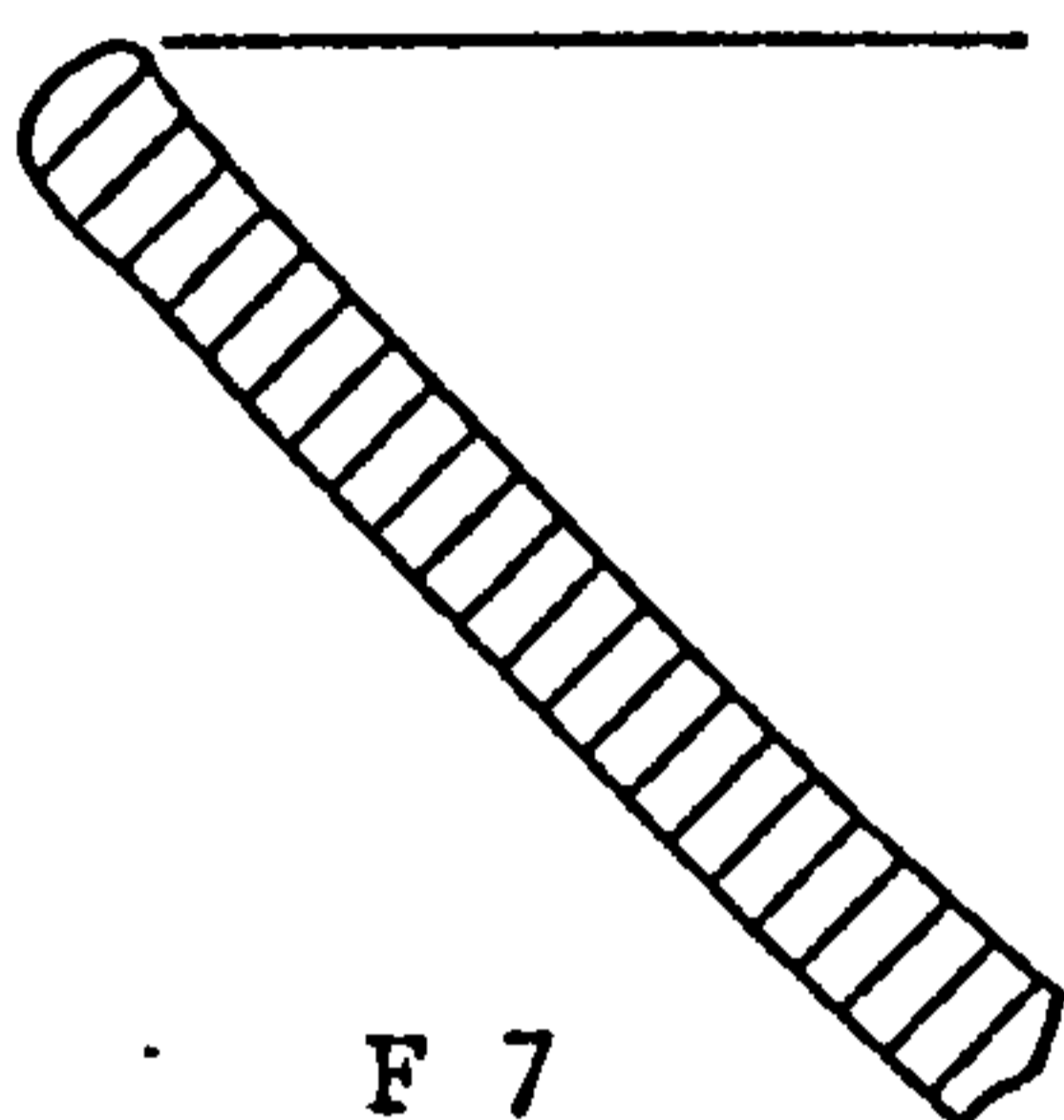

F 7

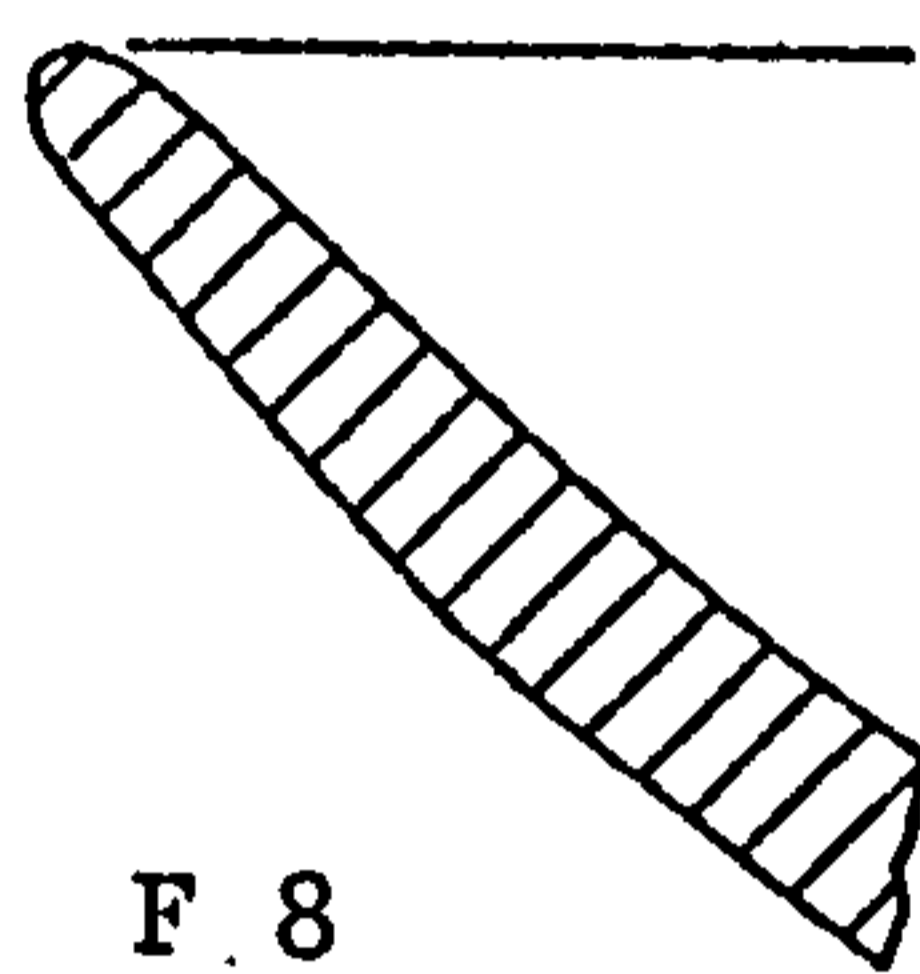

F 8

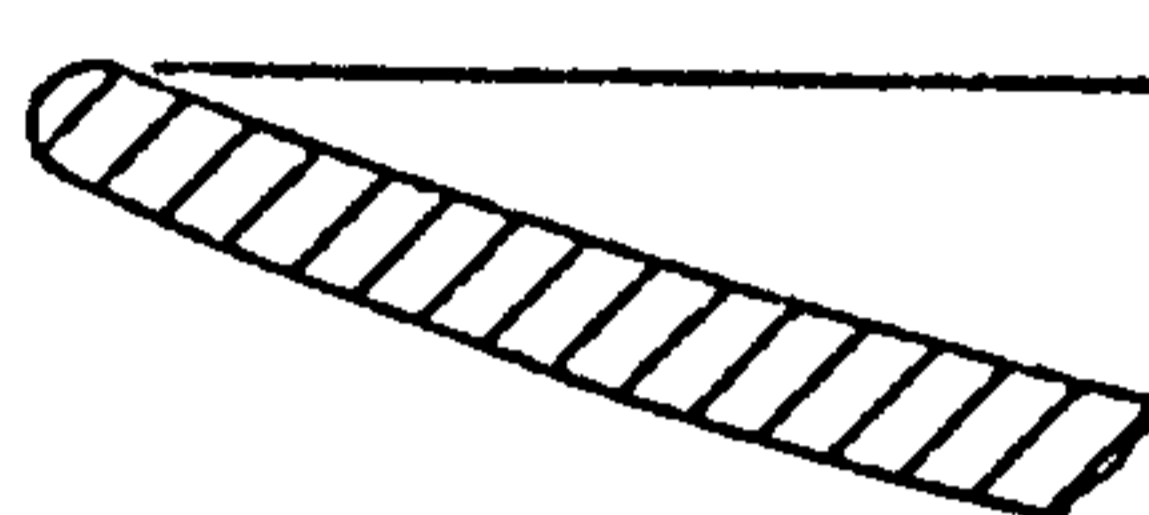

F 9

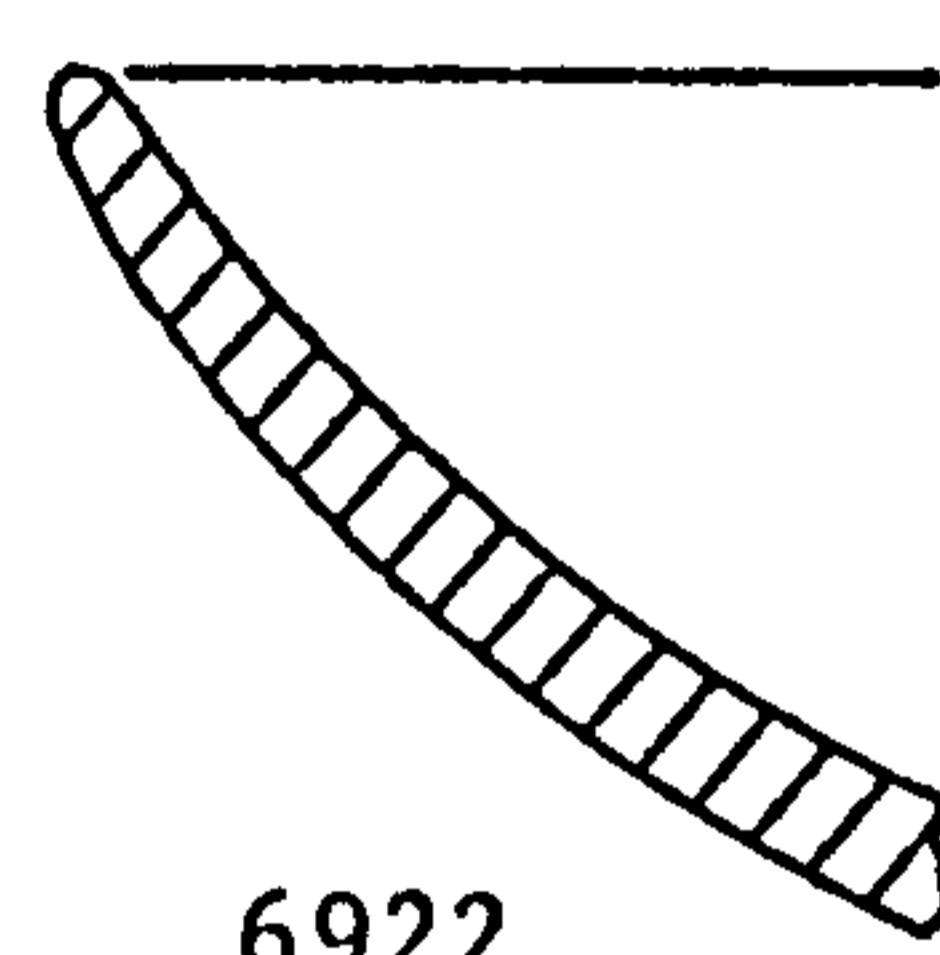

6922

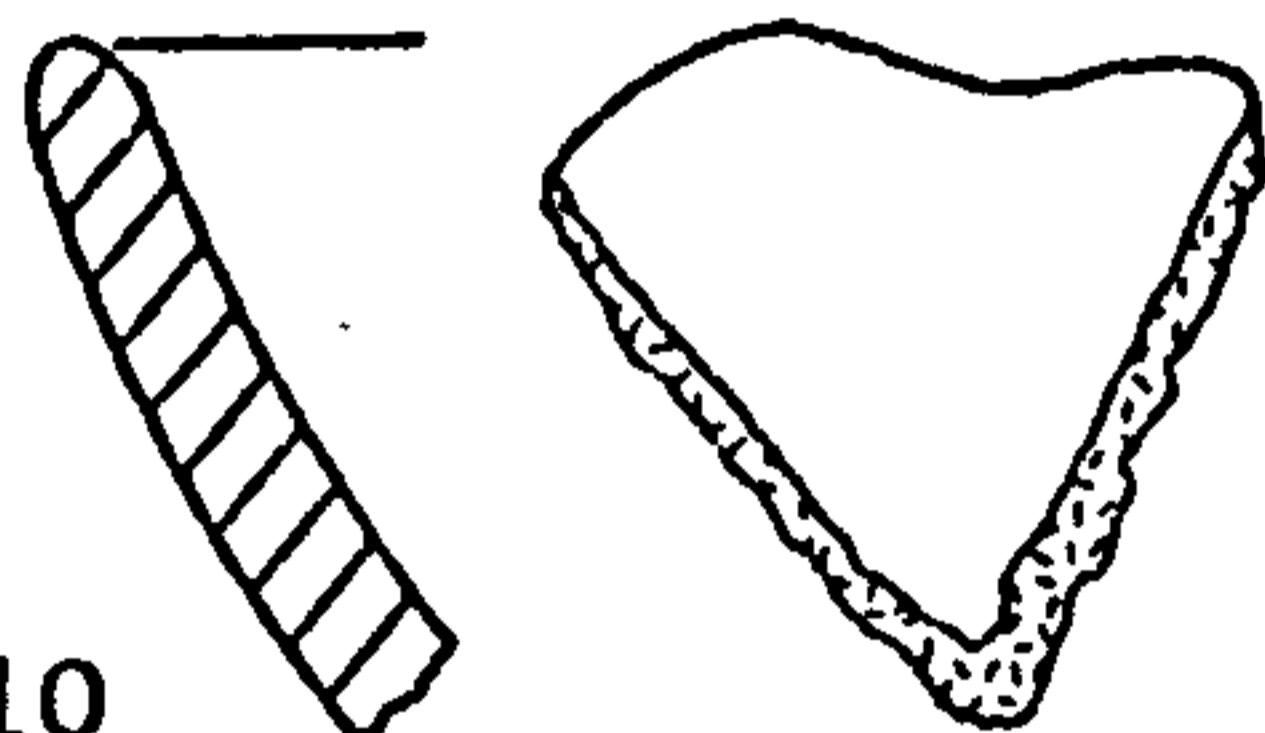

F 10

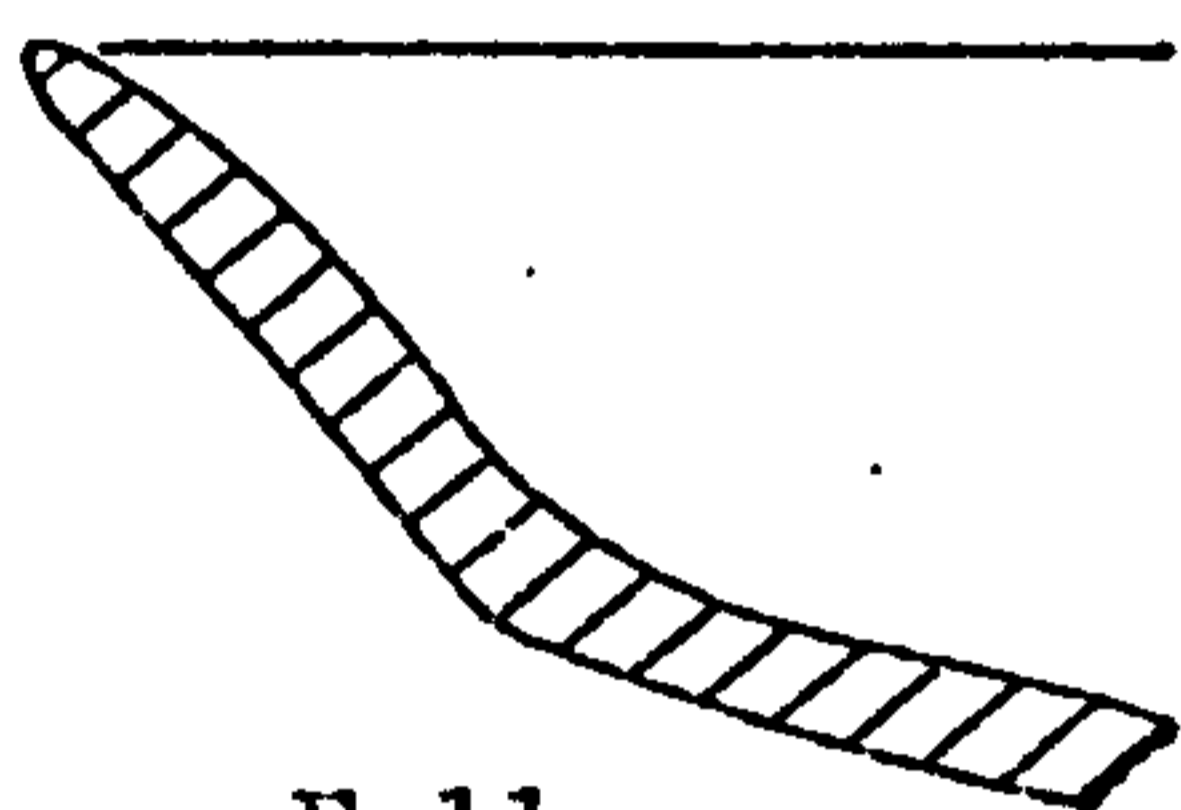

F 11

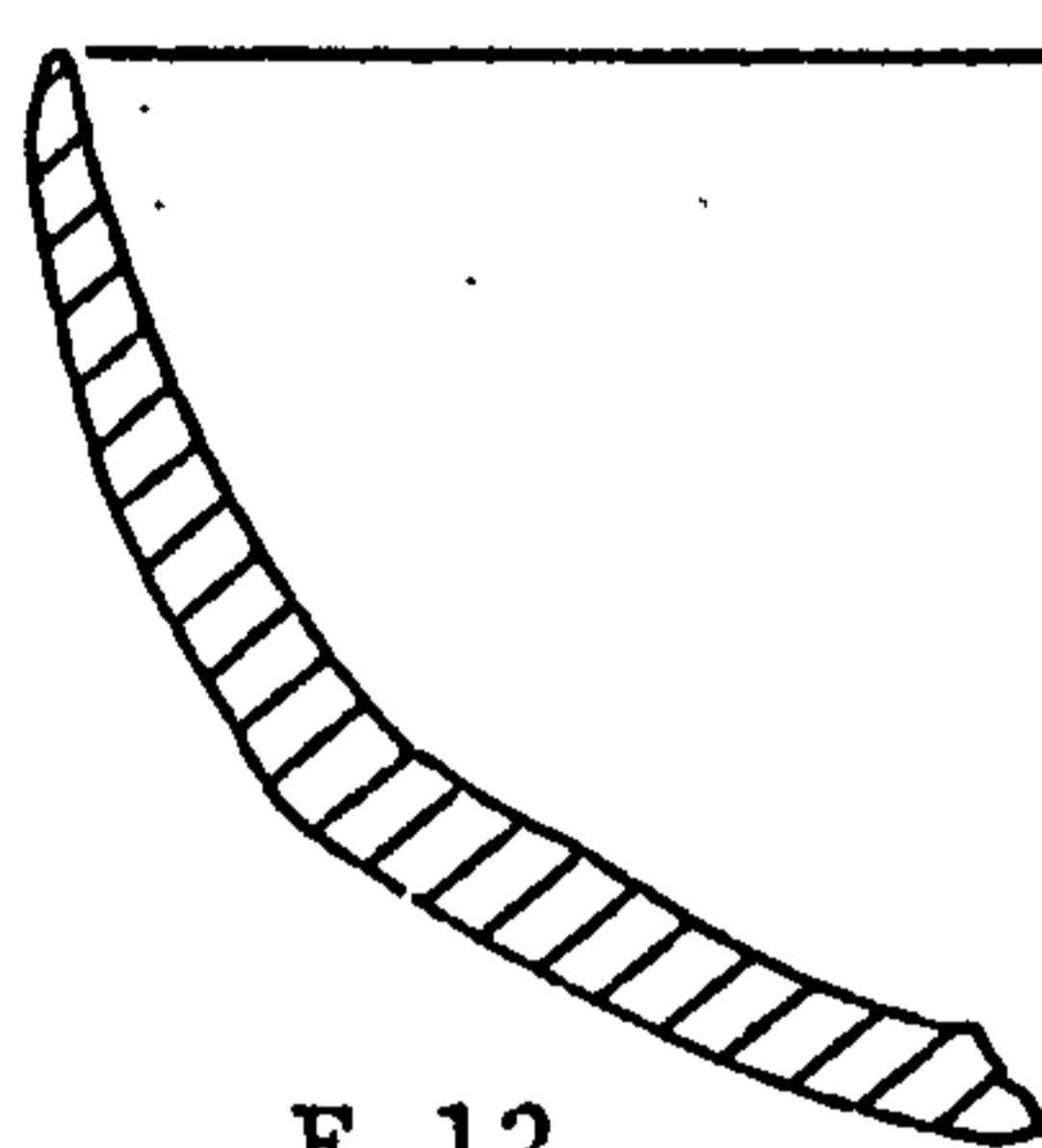

F 12

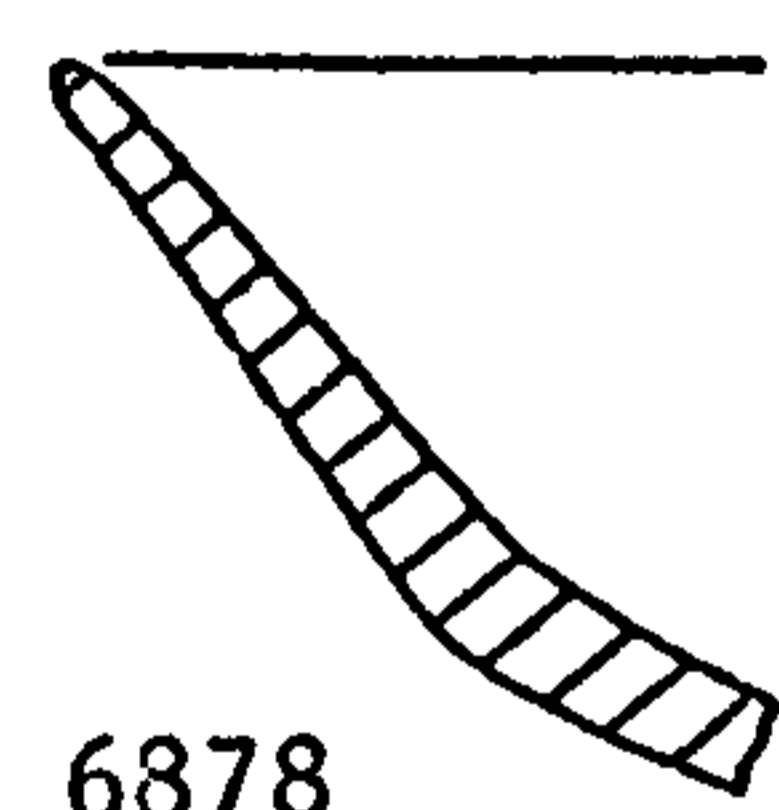

6878

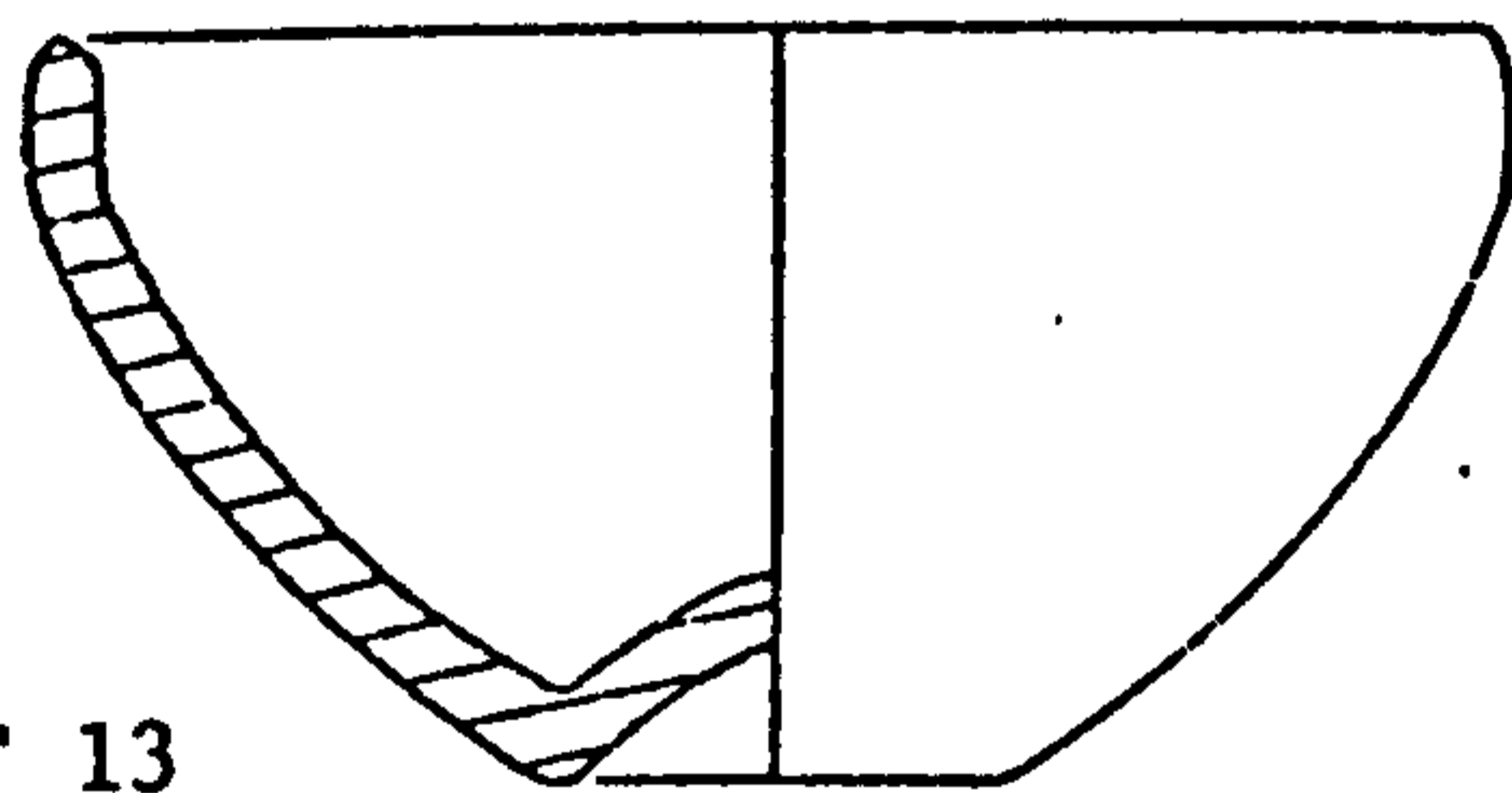

F 13

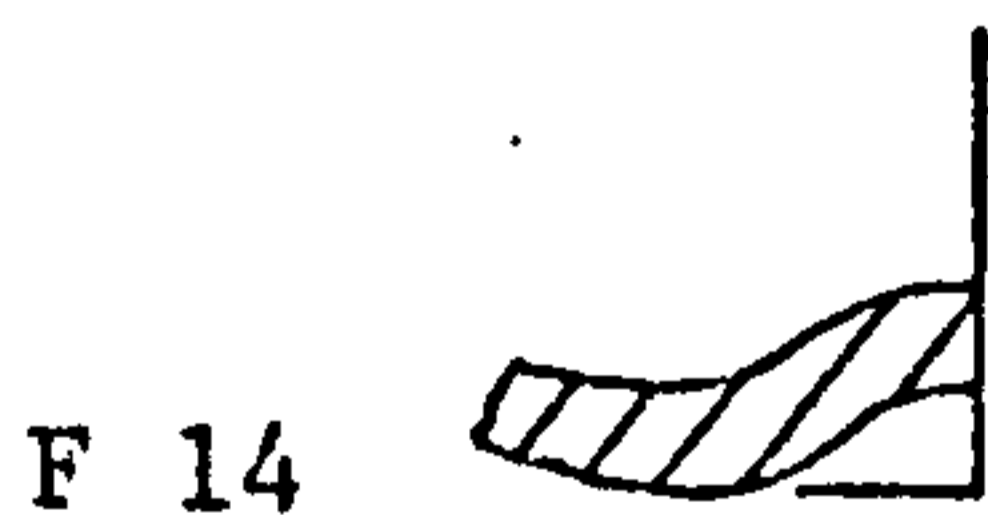

F 14

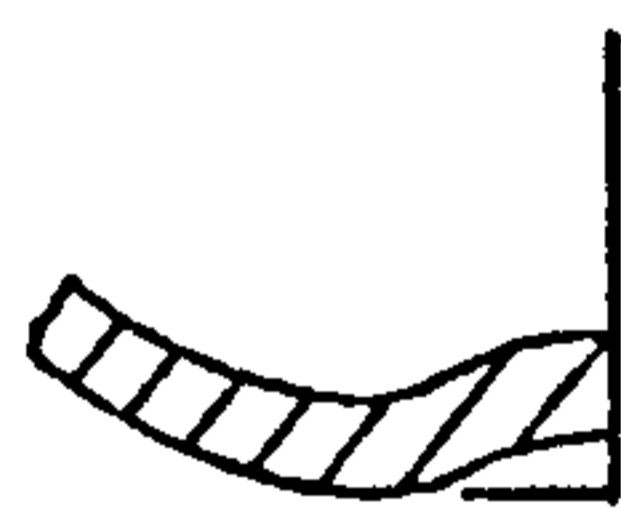

F 15

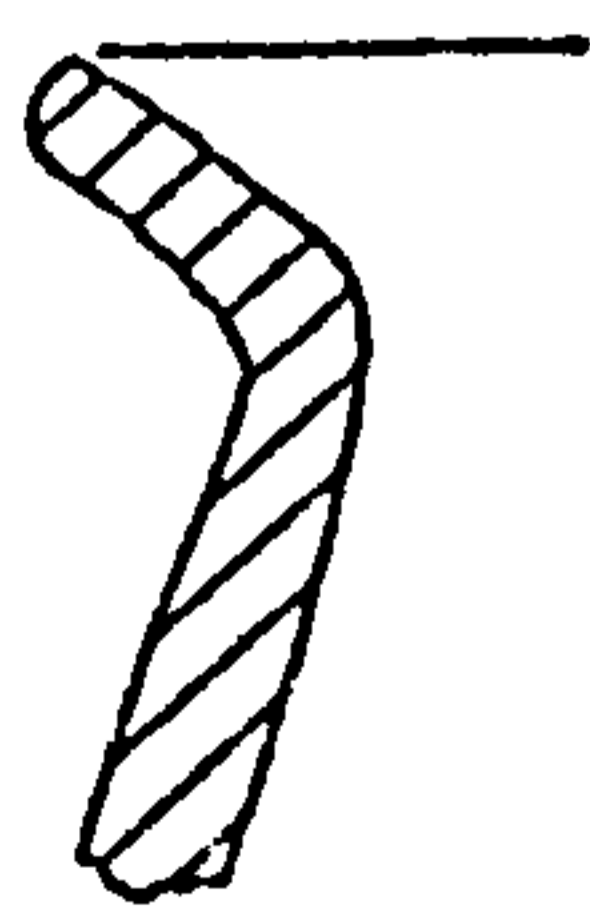

6904

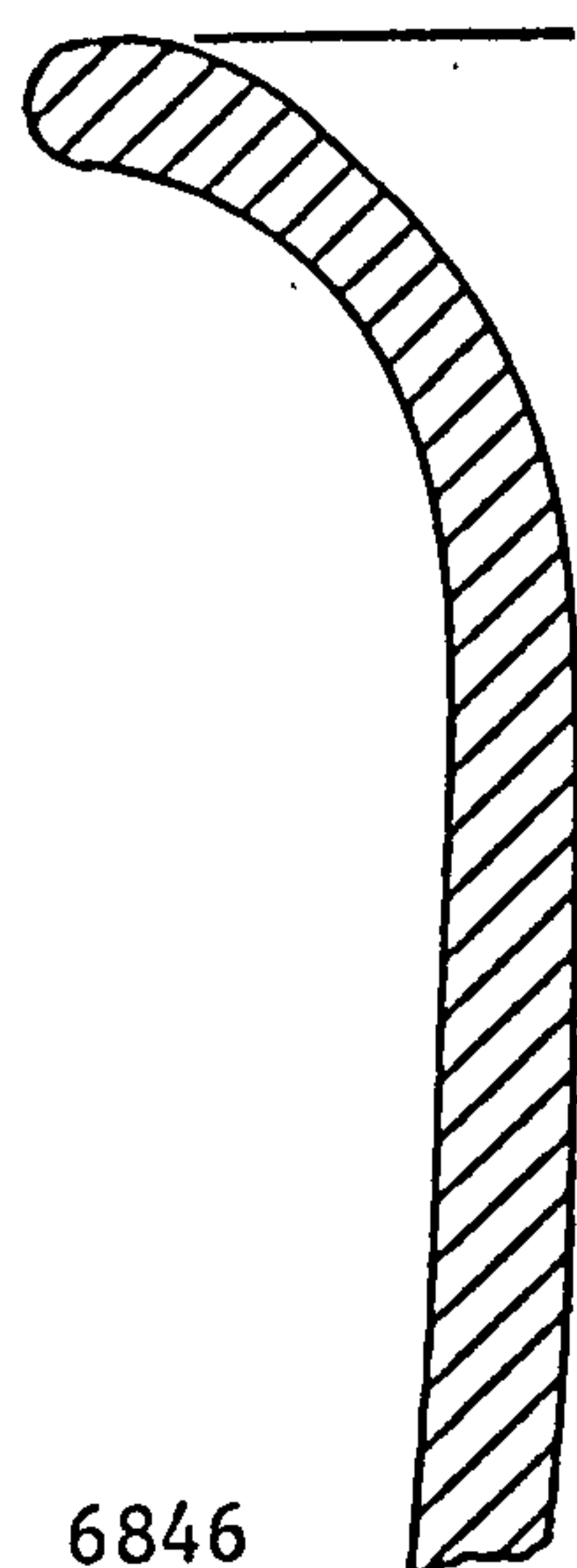

6846

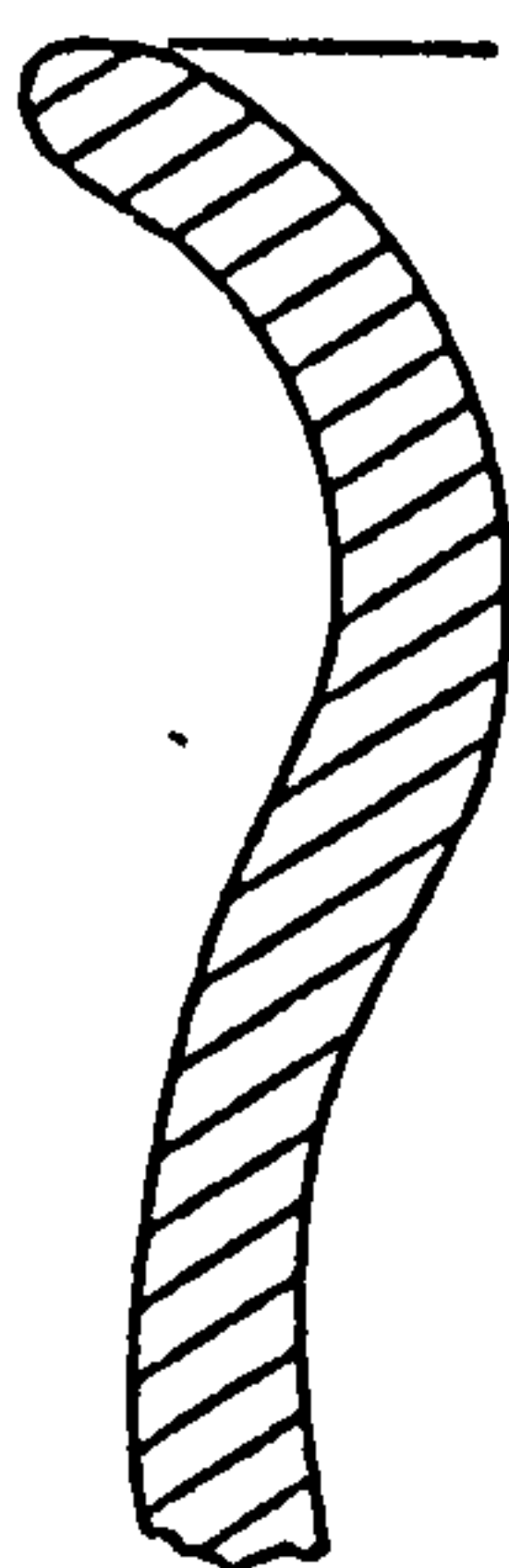

1659

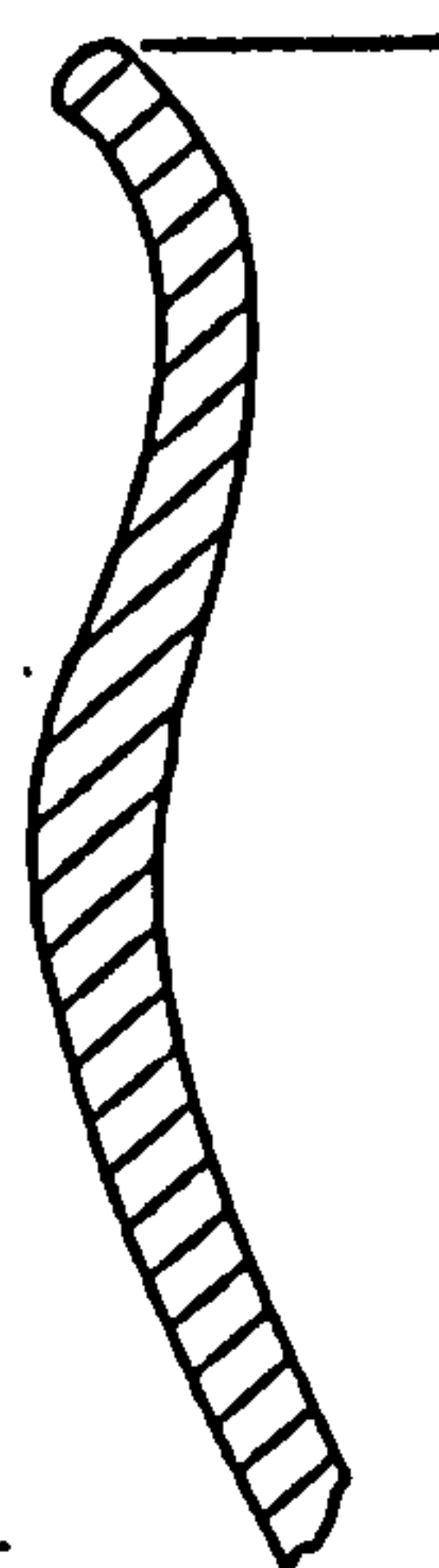

6801

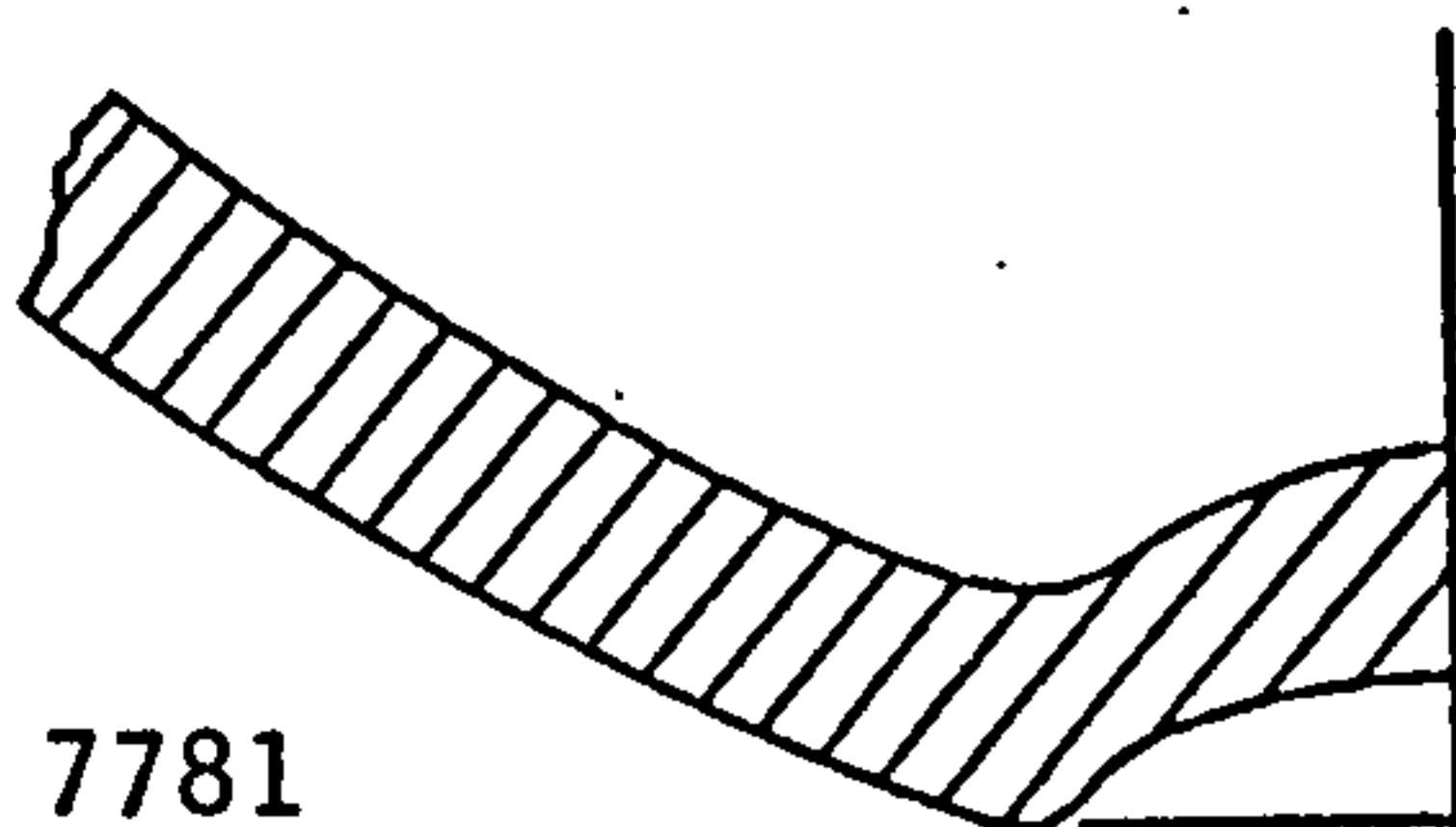

7781

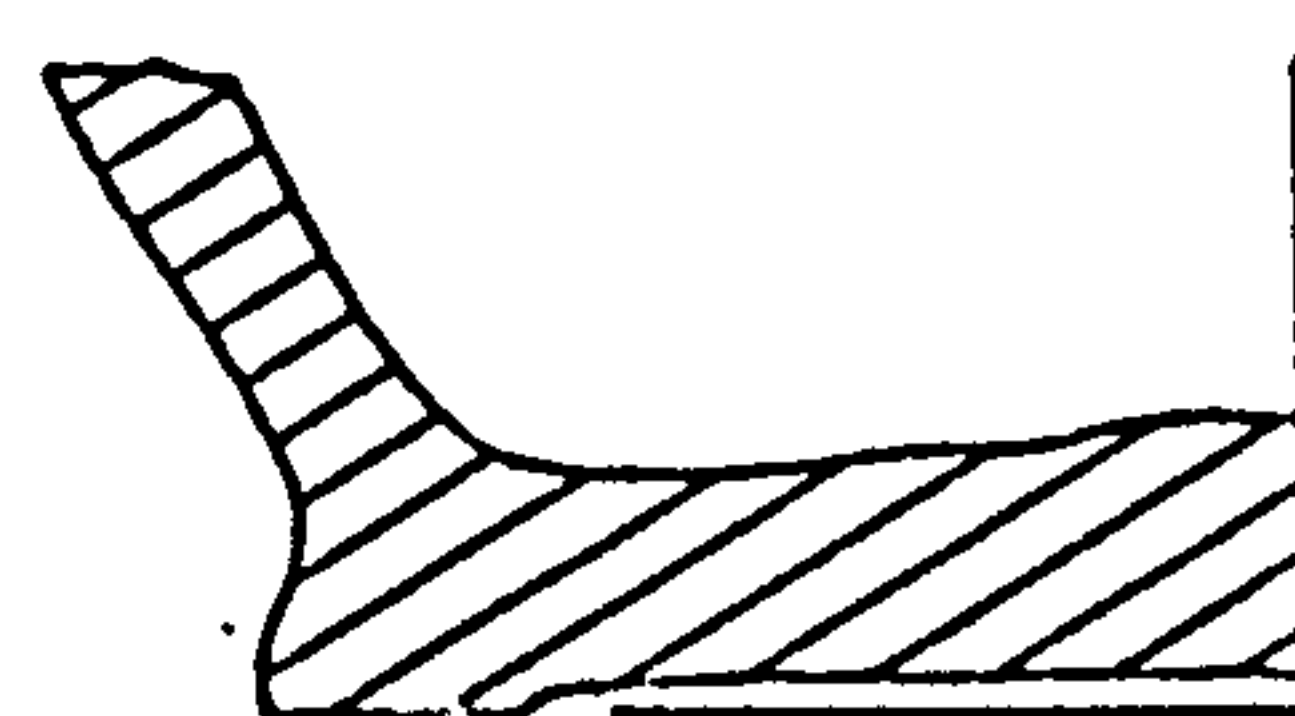

6810

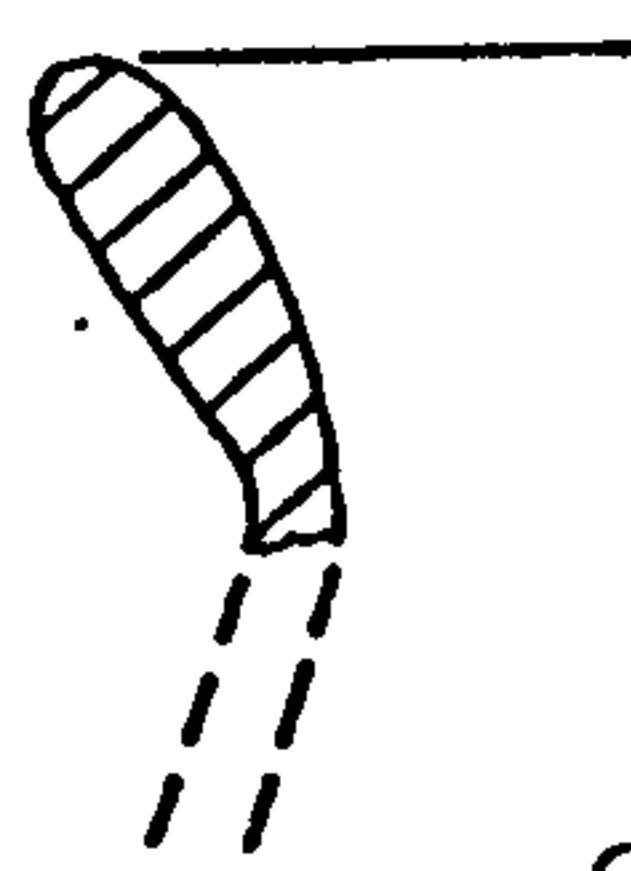

2663

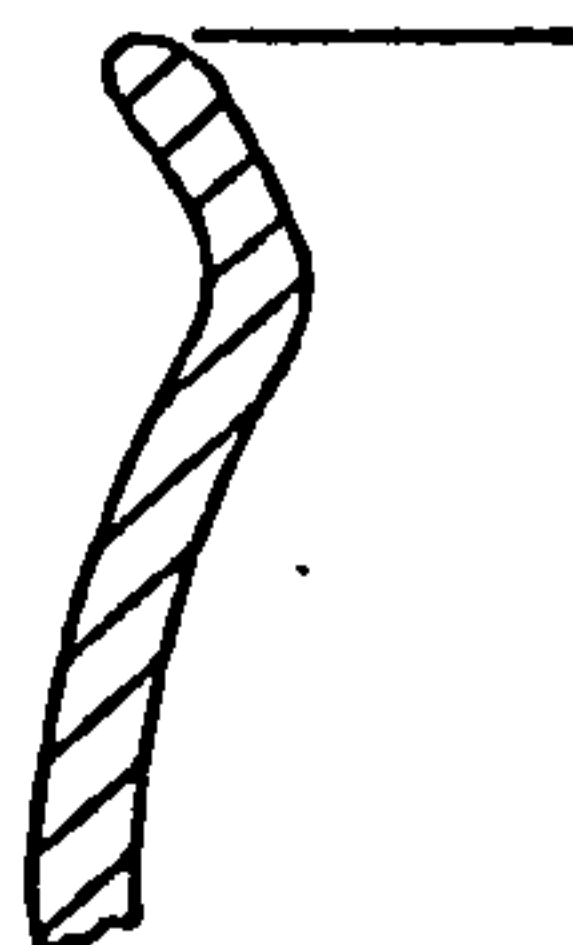

6802

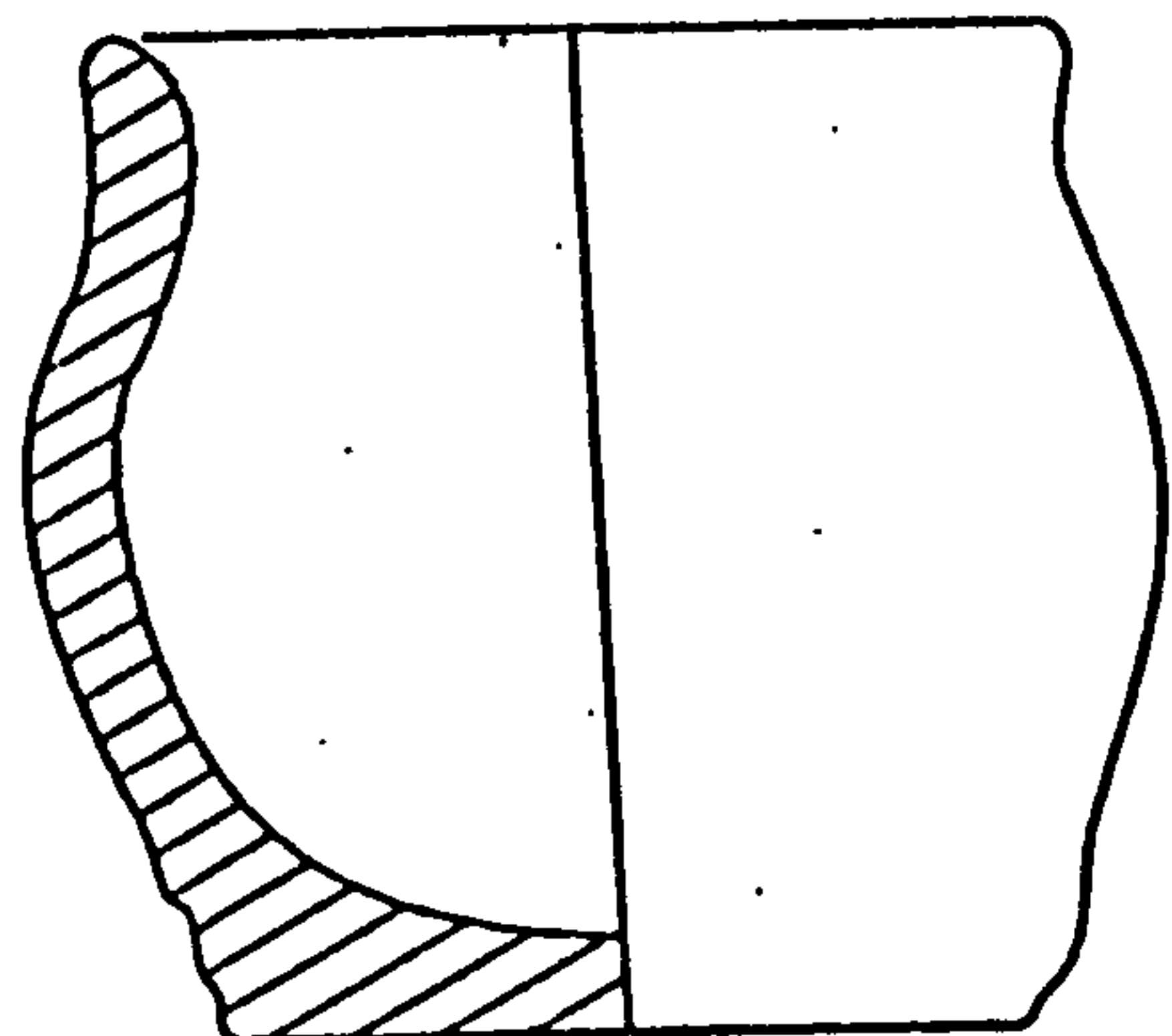

8255

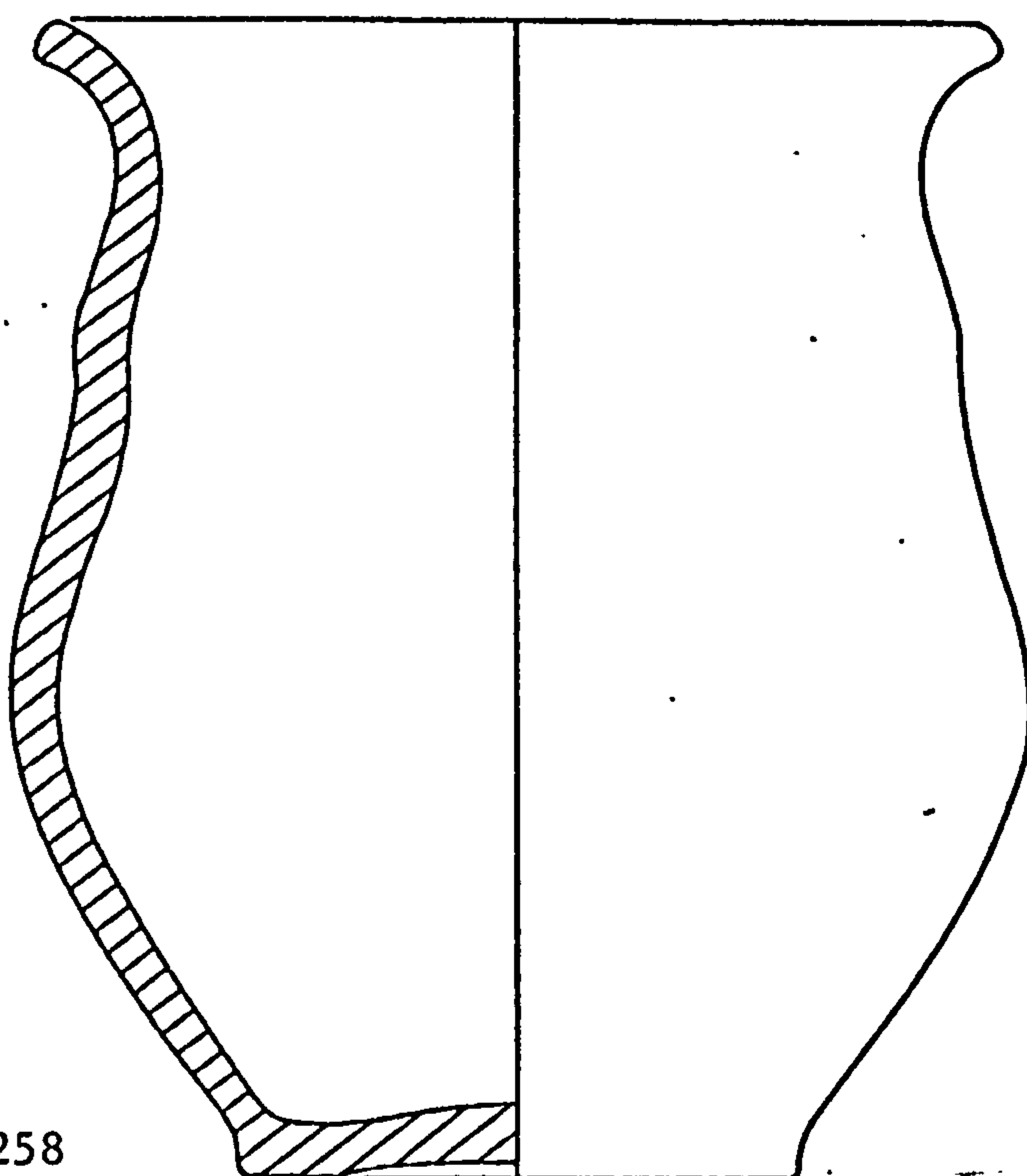

8258

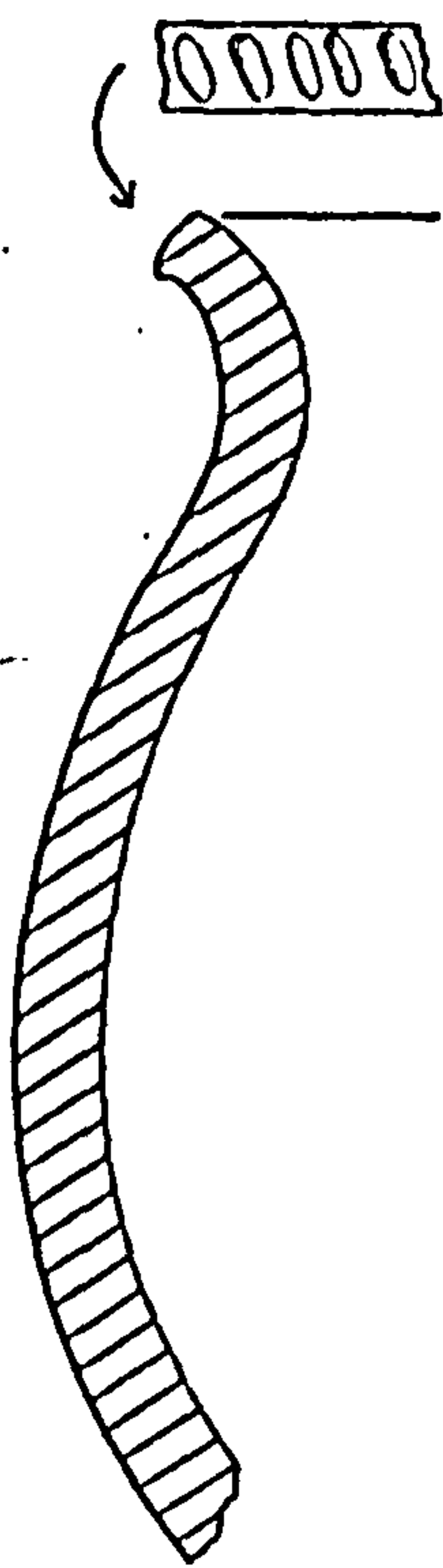

7777

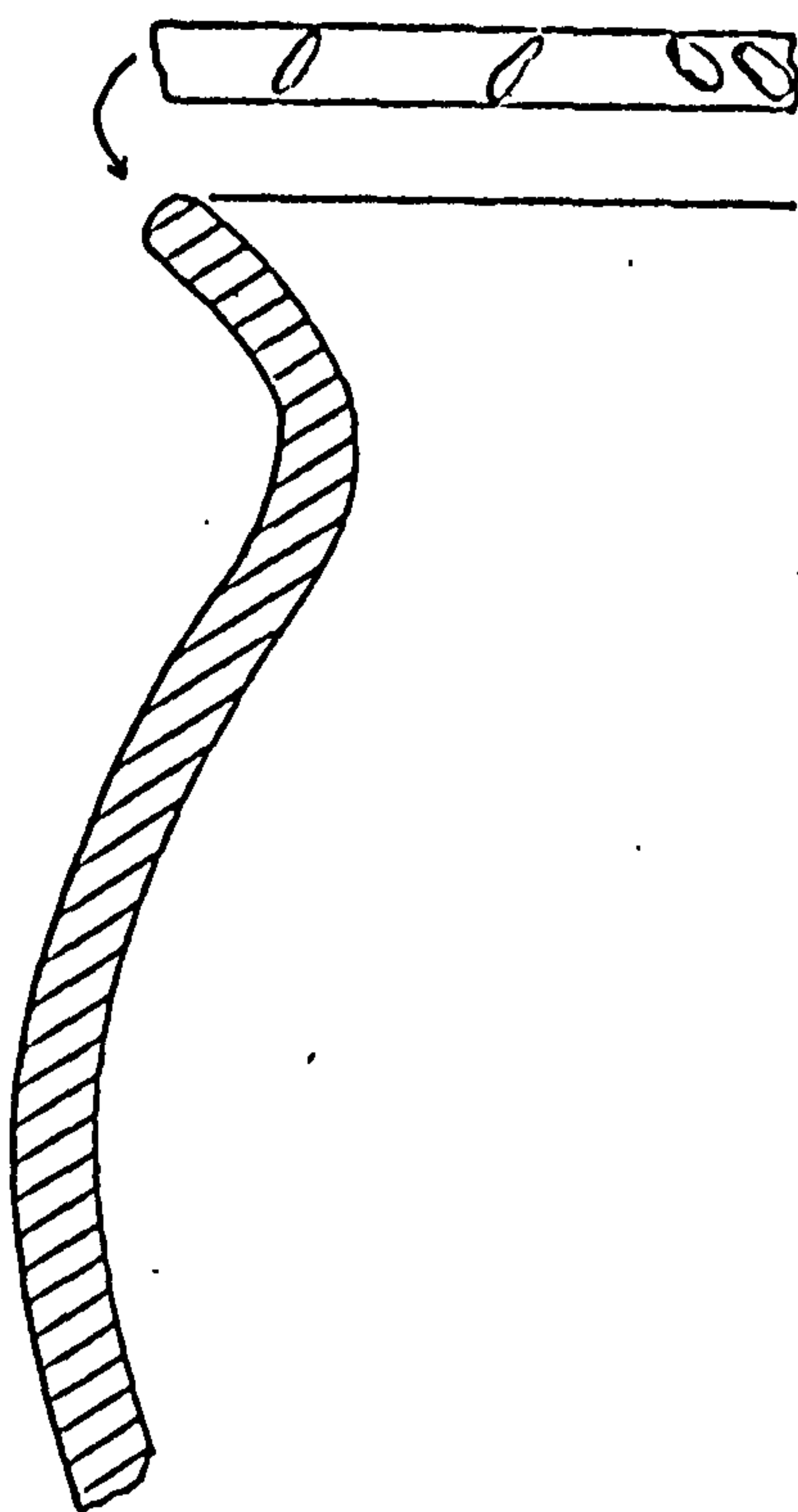

7778

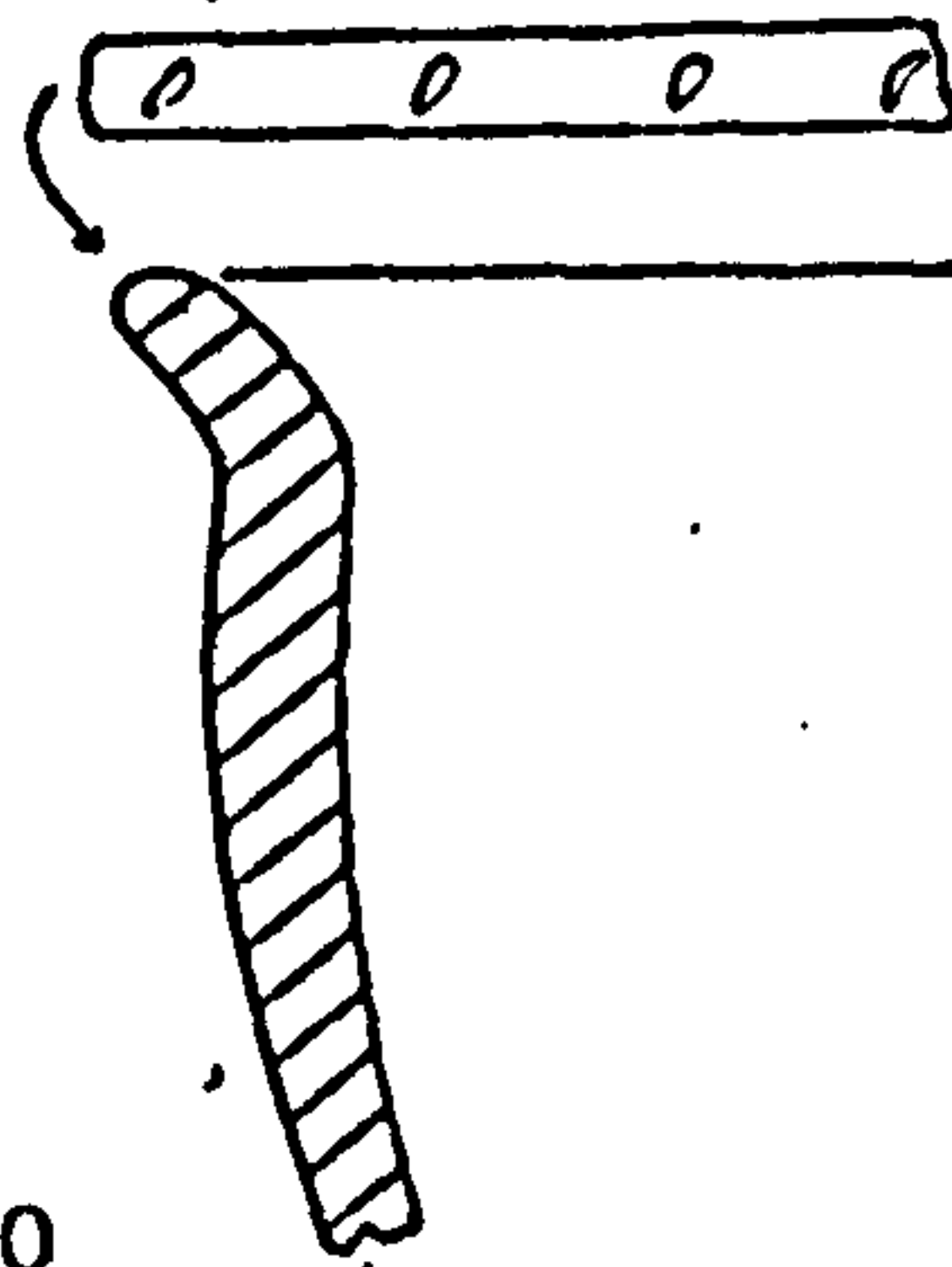

6860

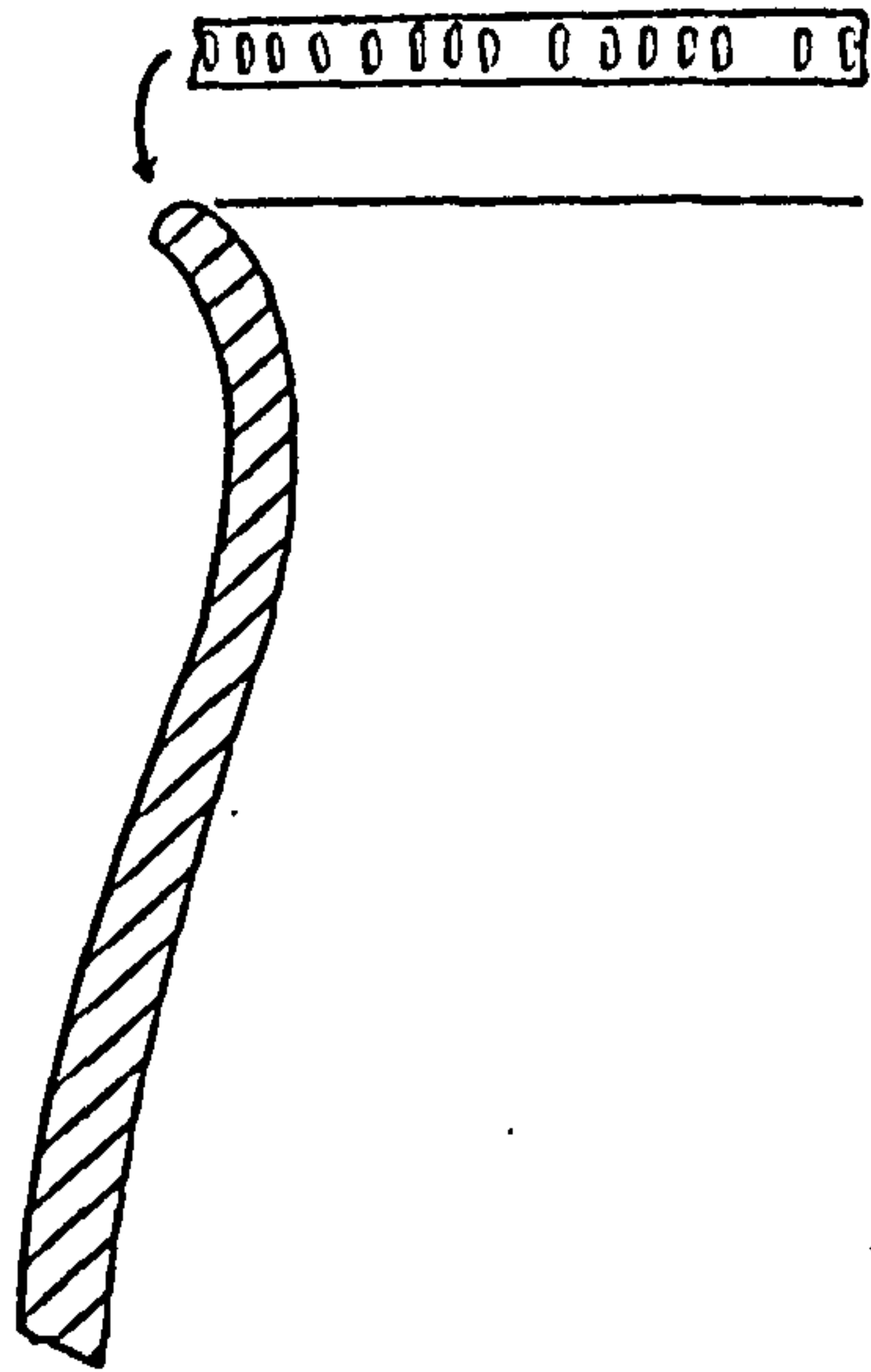

259

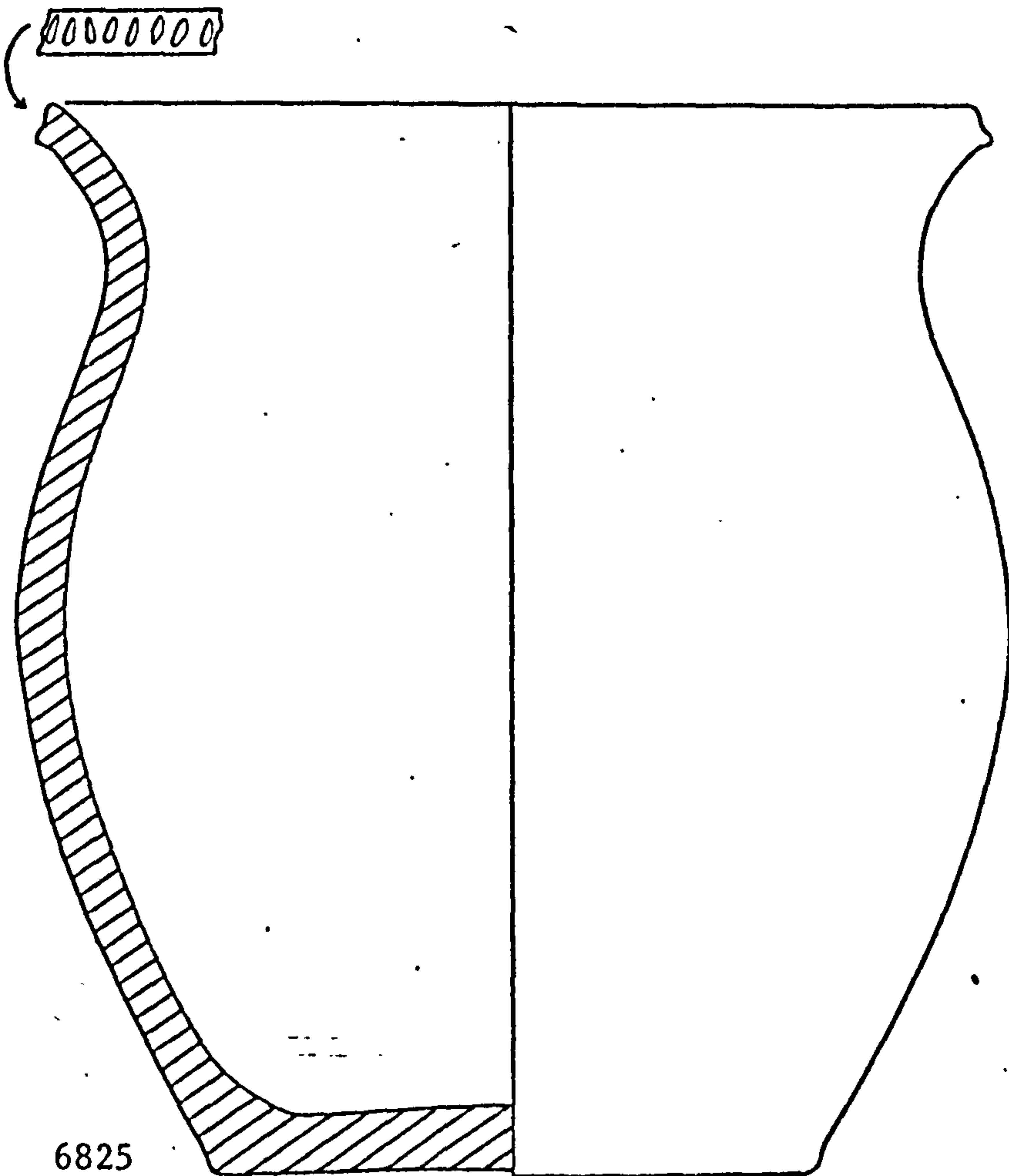

6825

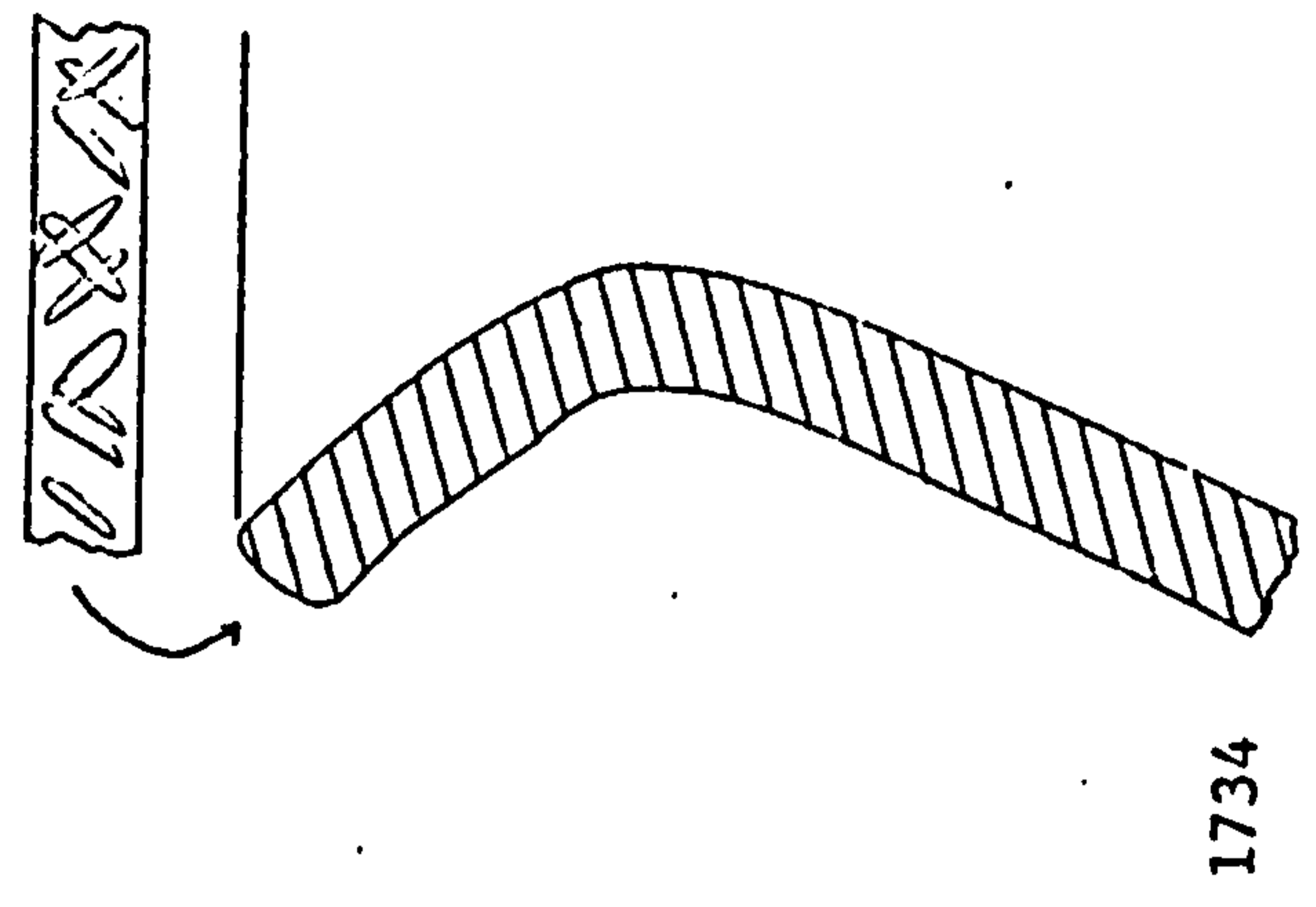
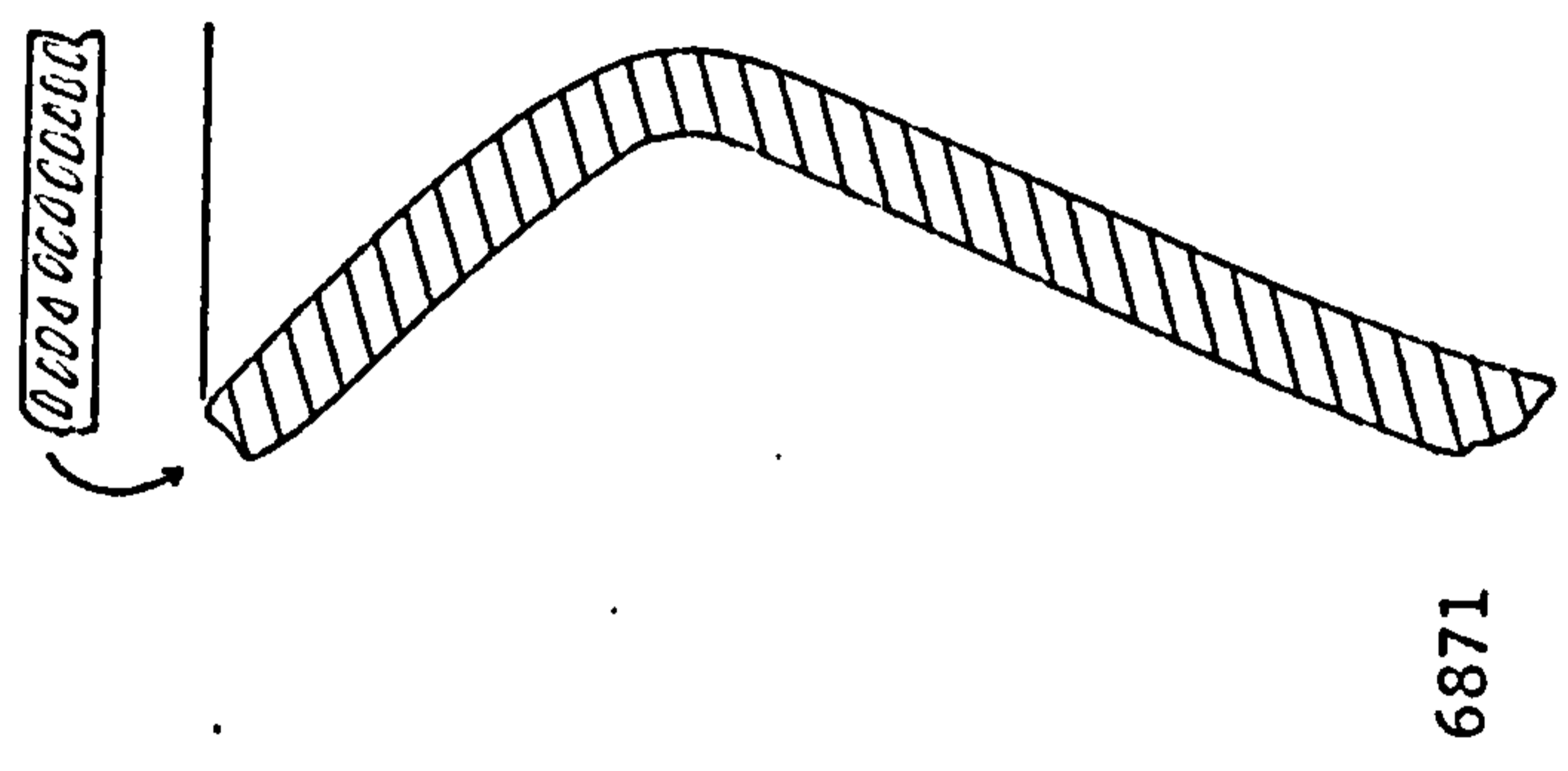
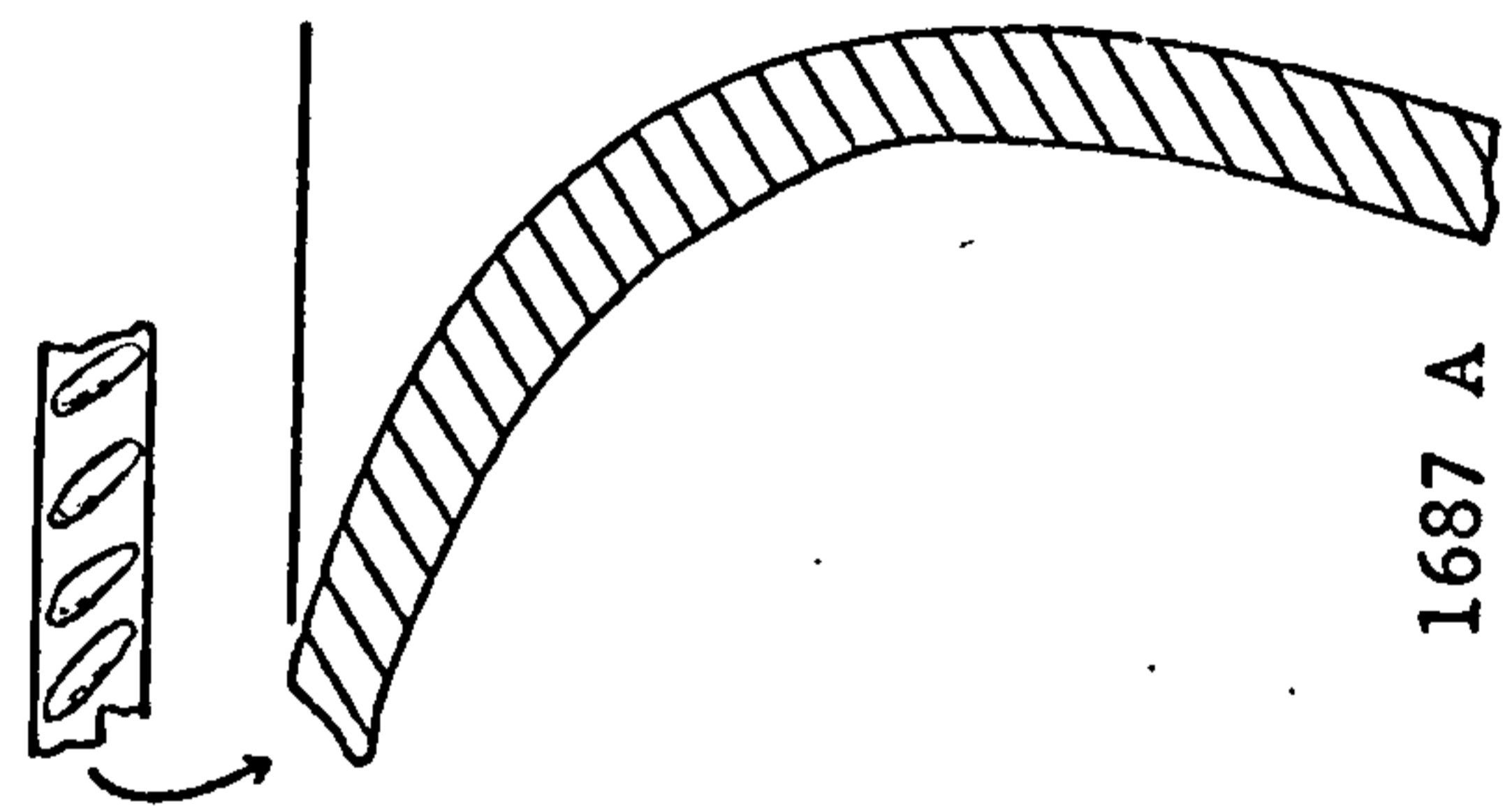
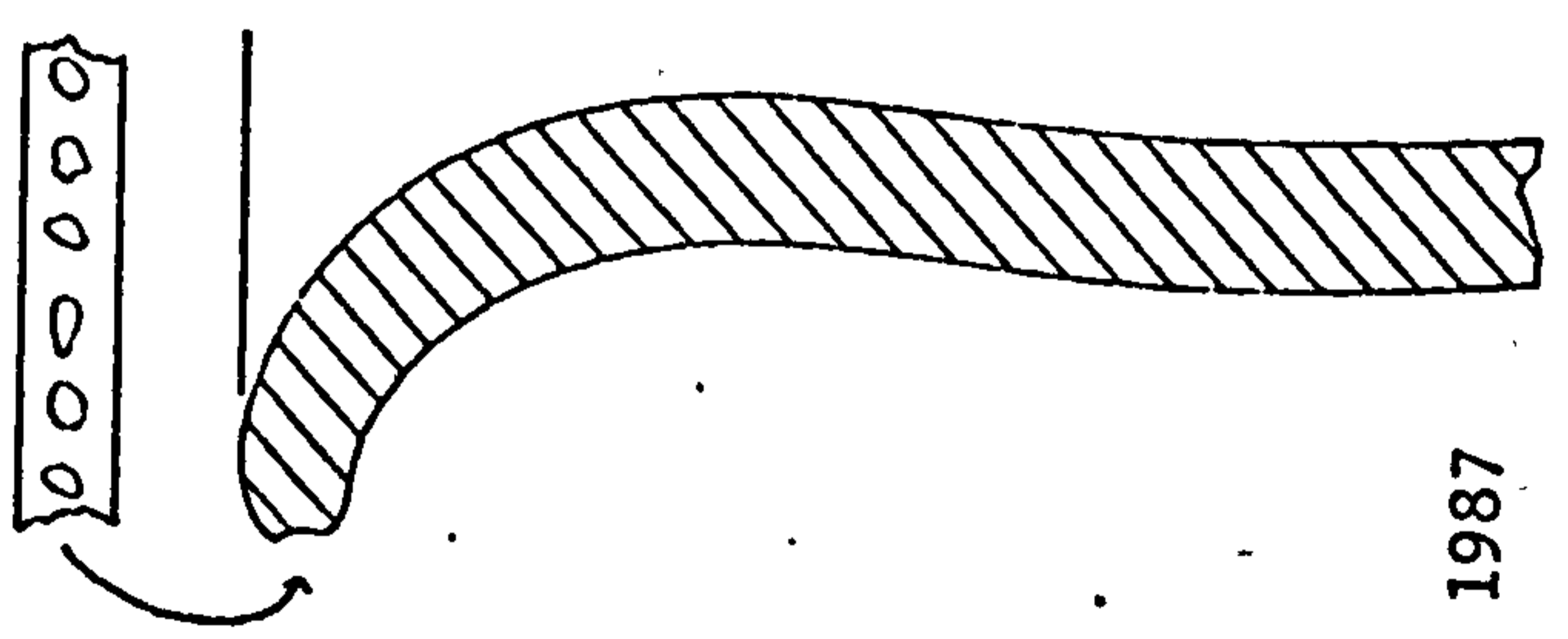
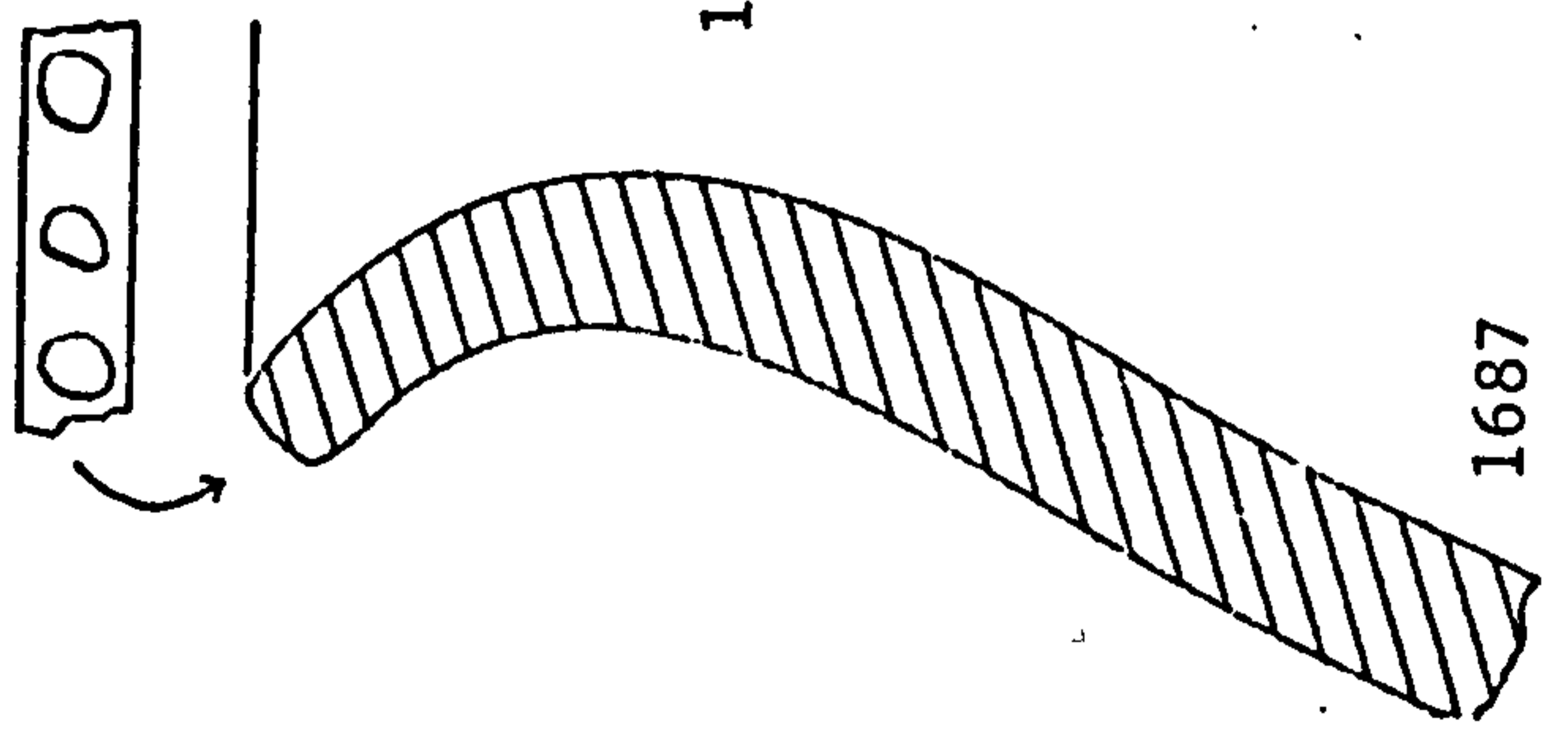
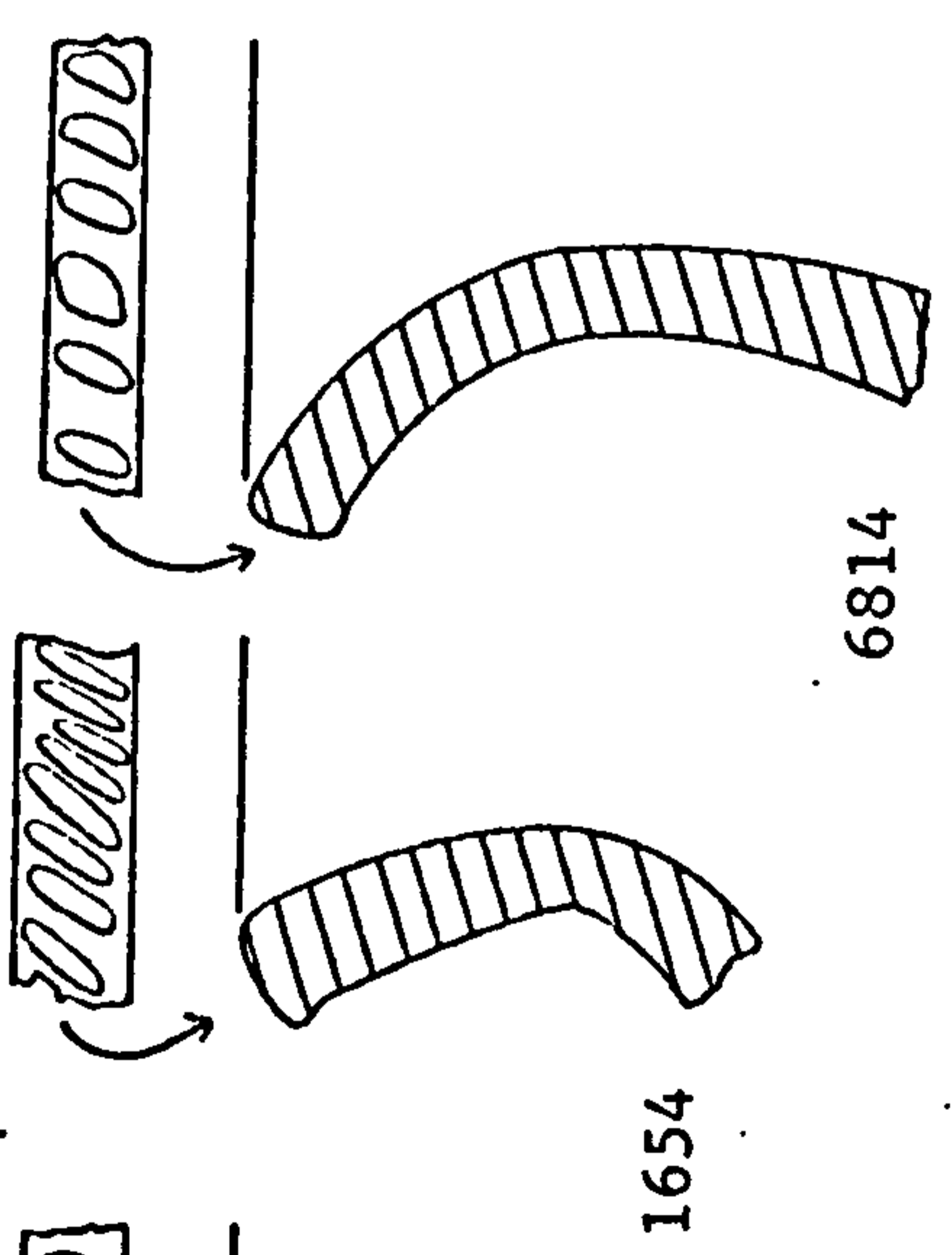
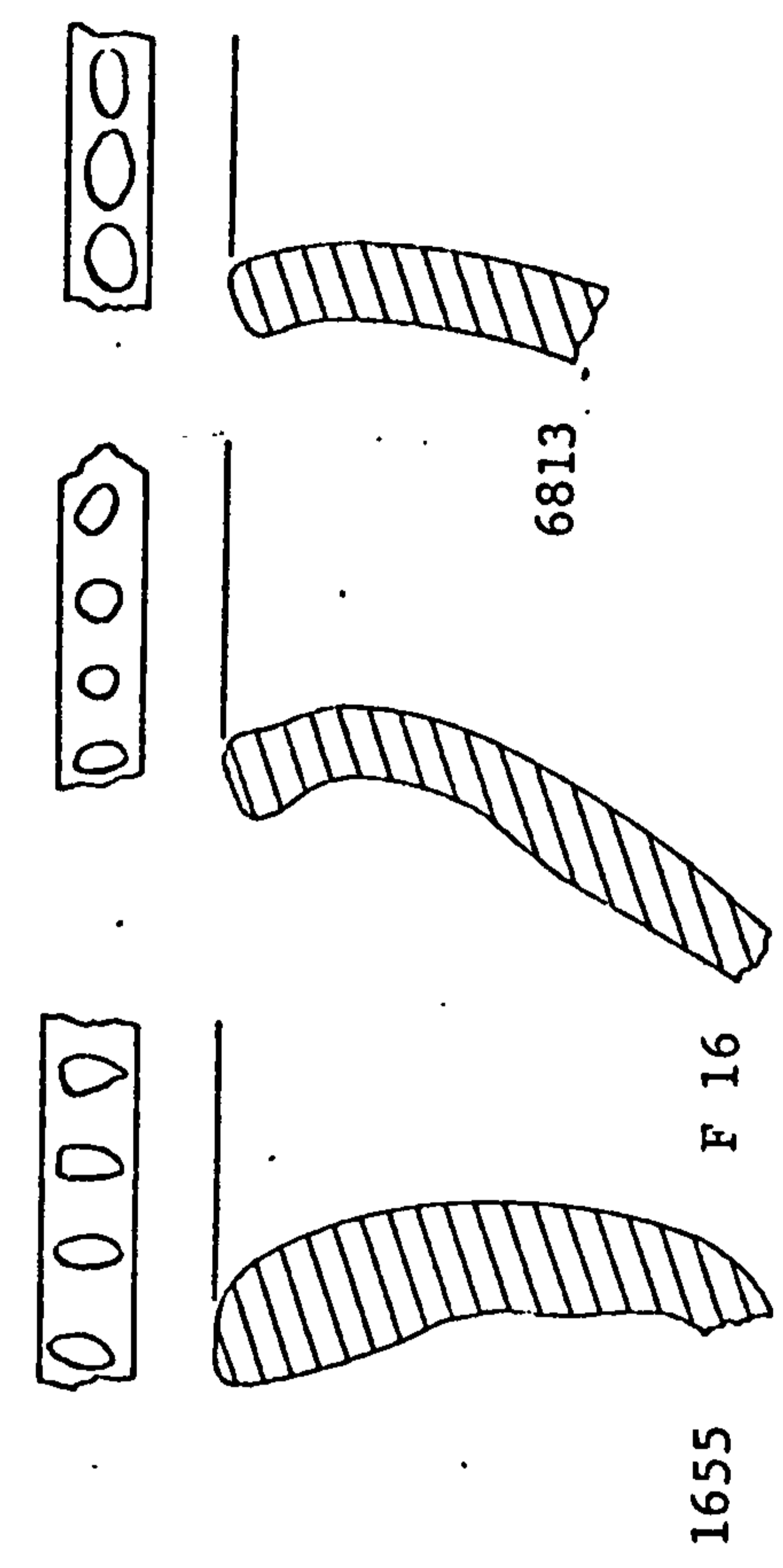

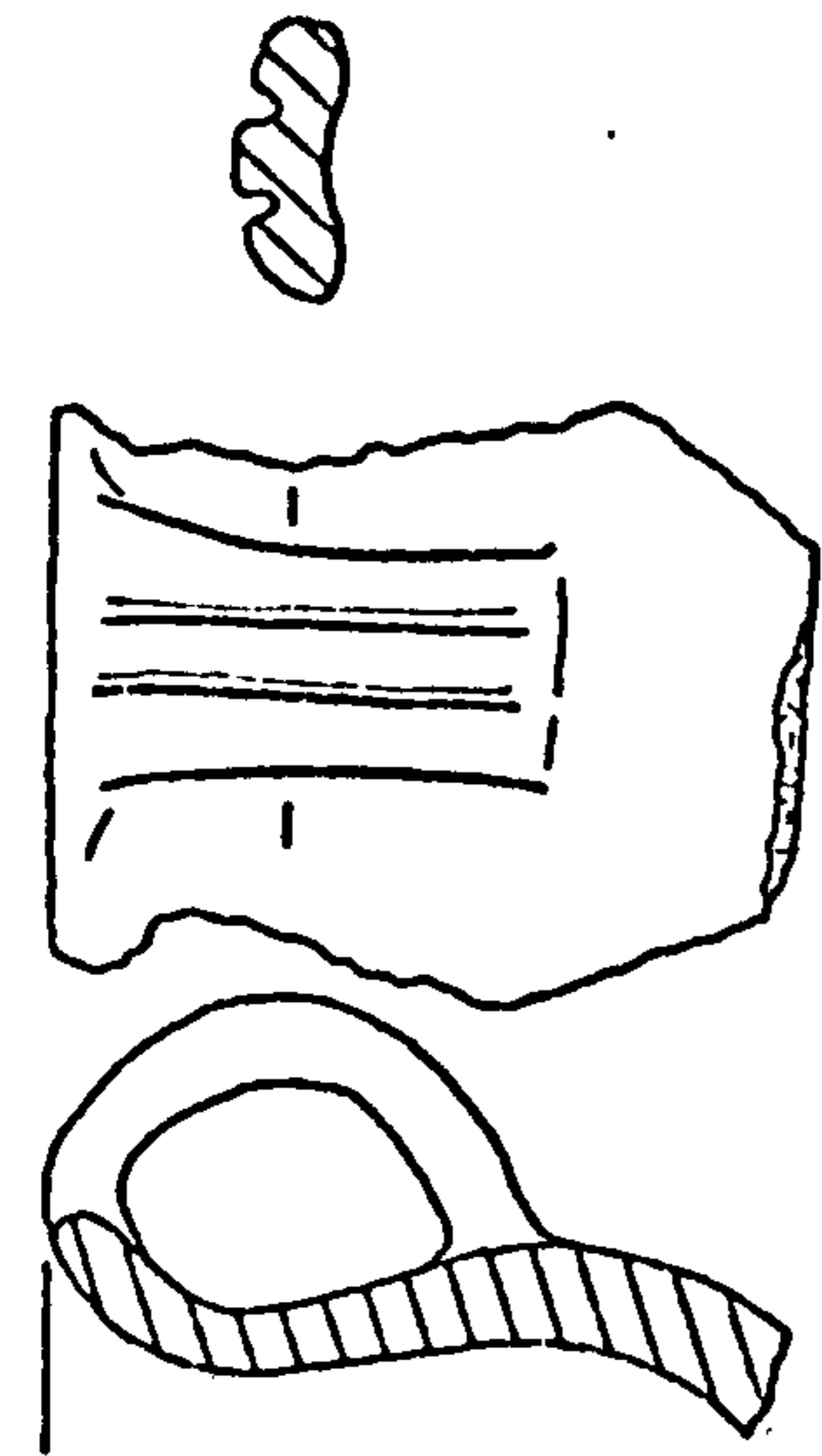

6854

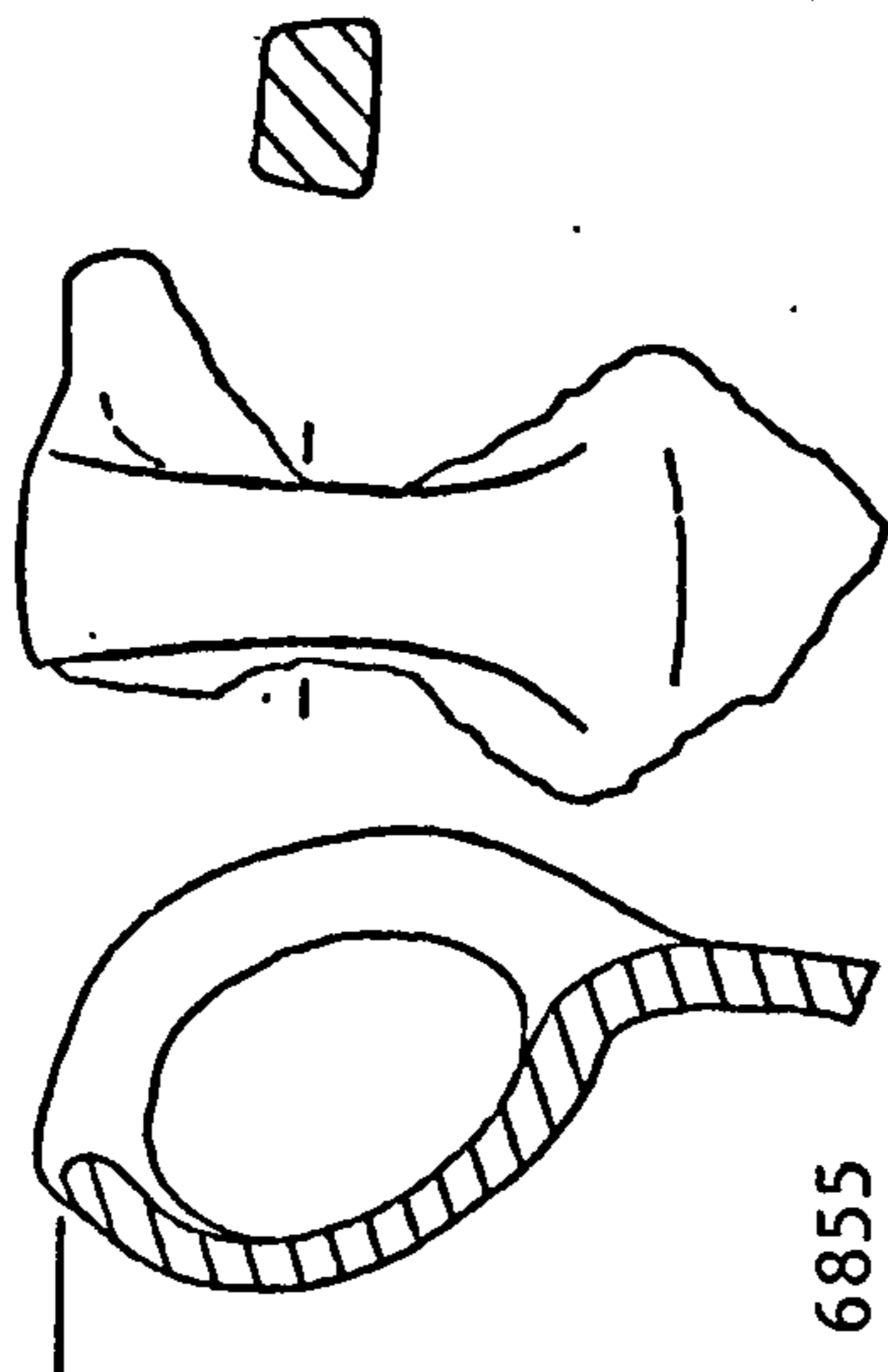

6855

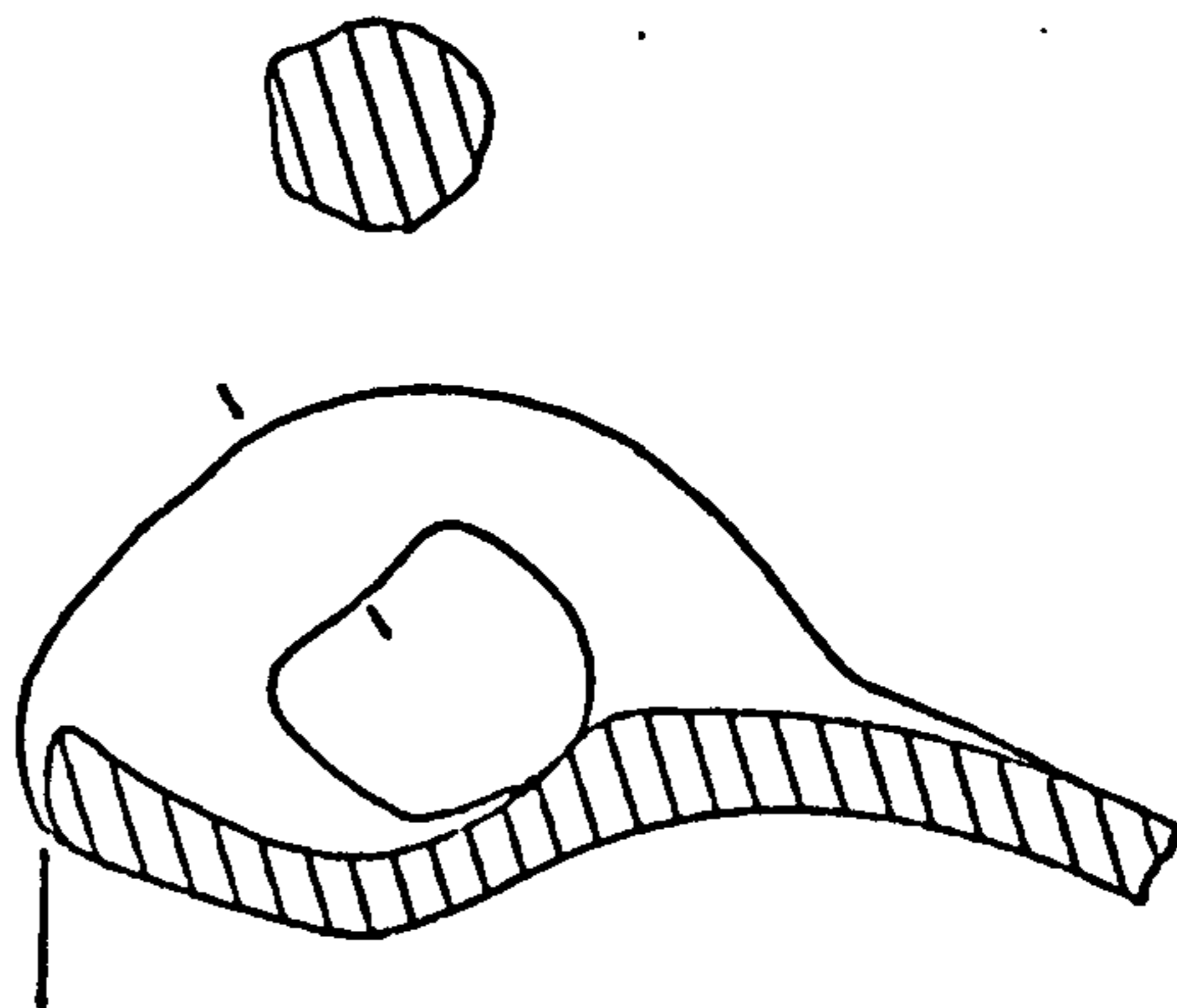

1590

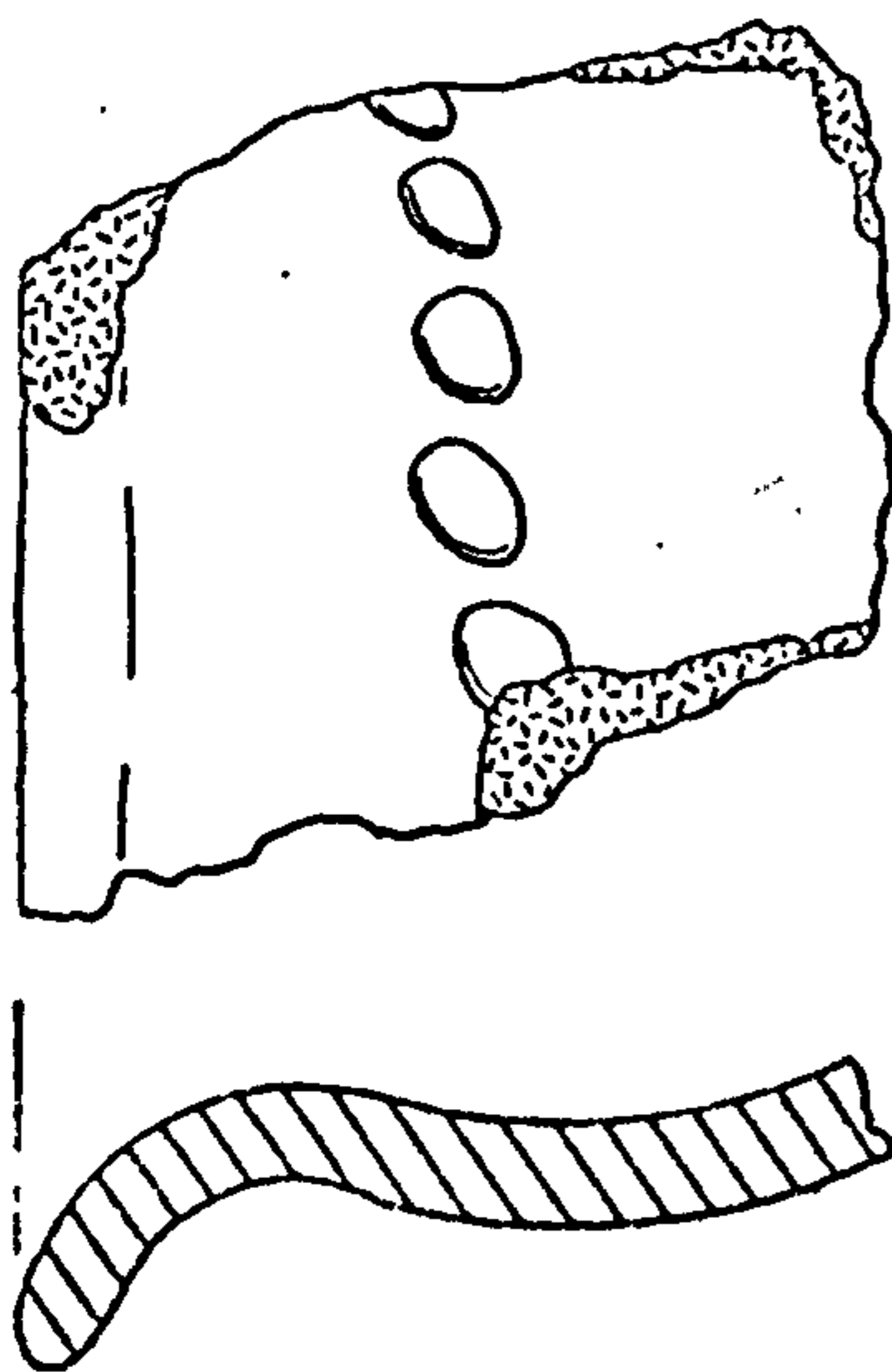

6856

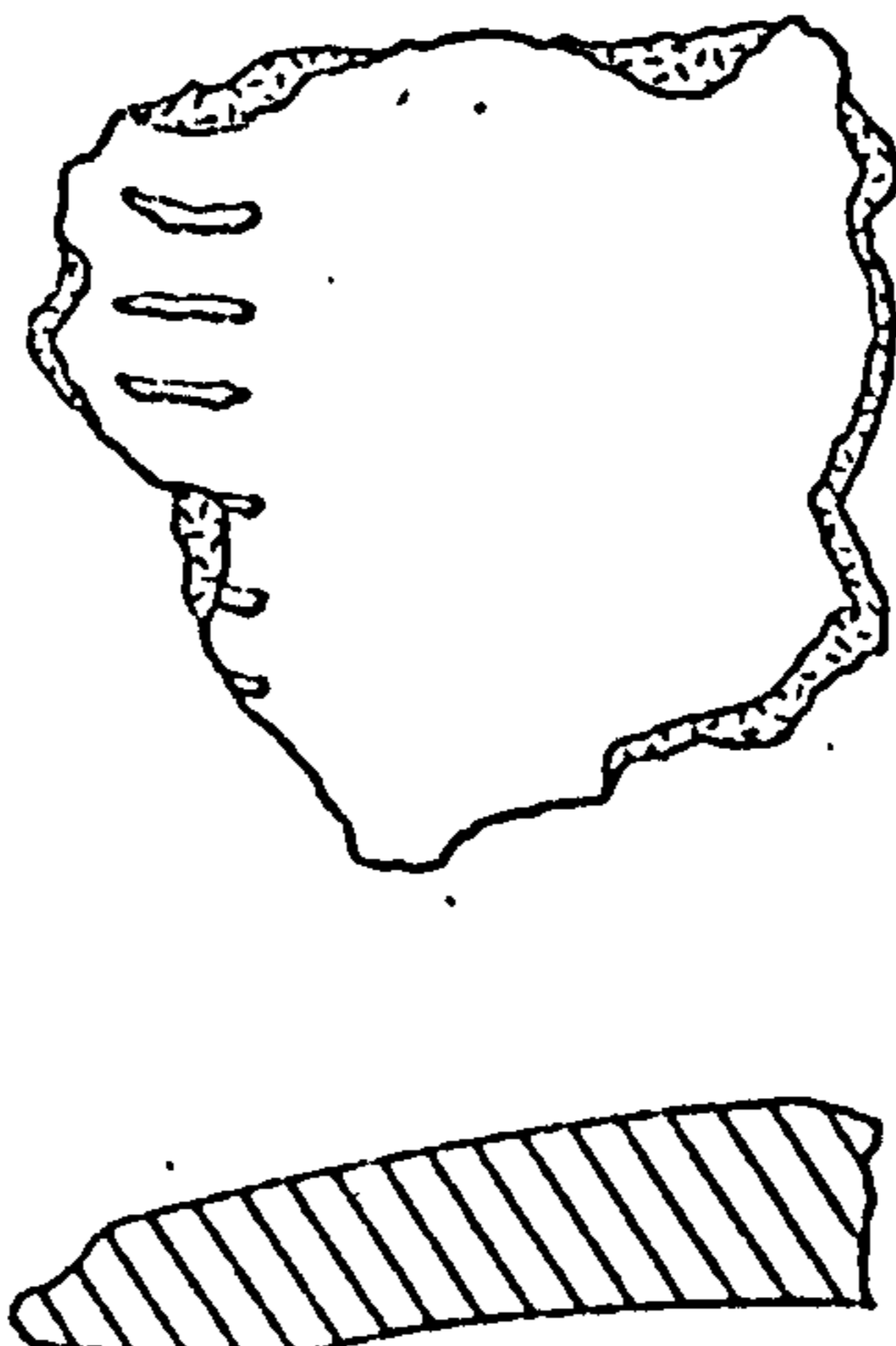

6858

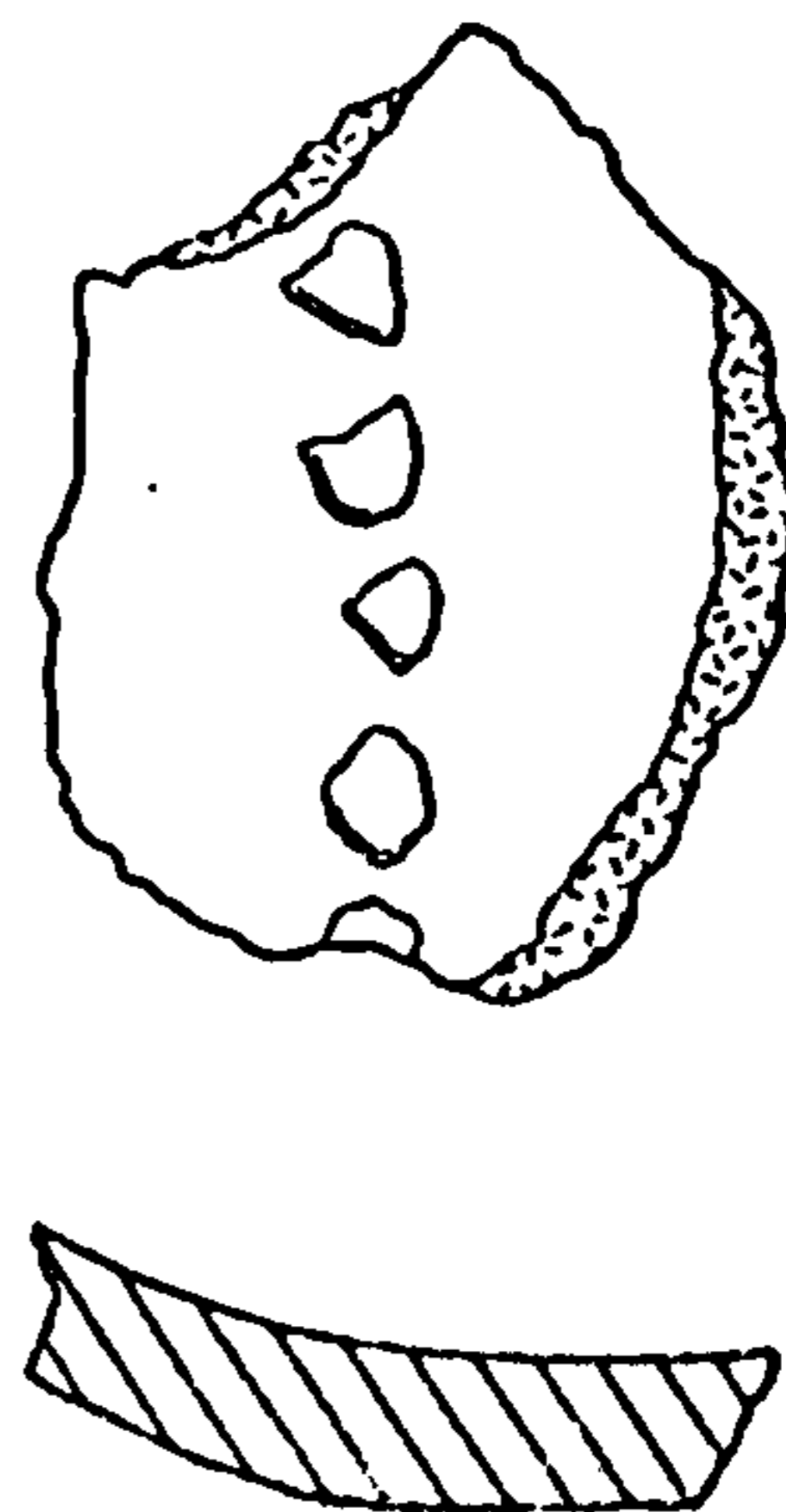

6857

Plate 7: SANTA OLAYA

0 _____ 10 cm

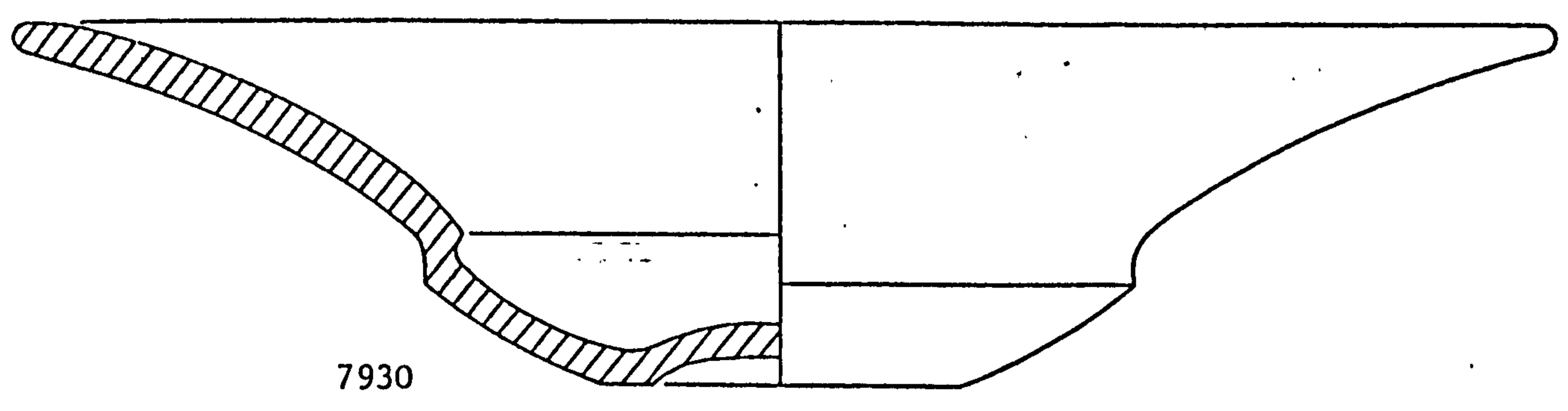

7930

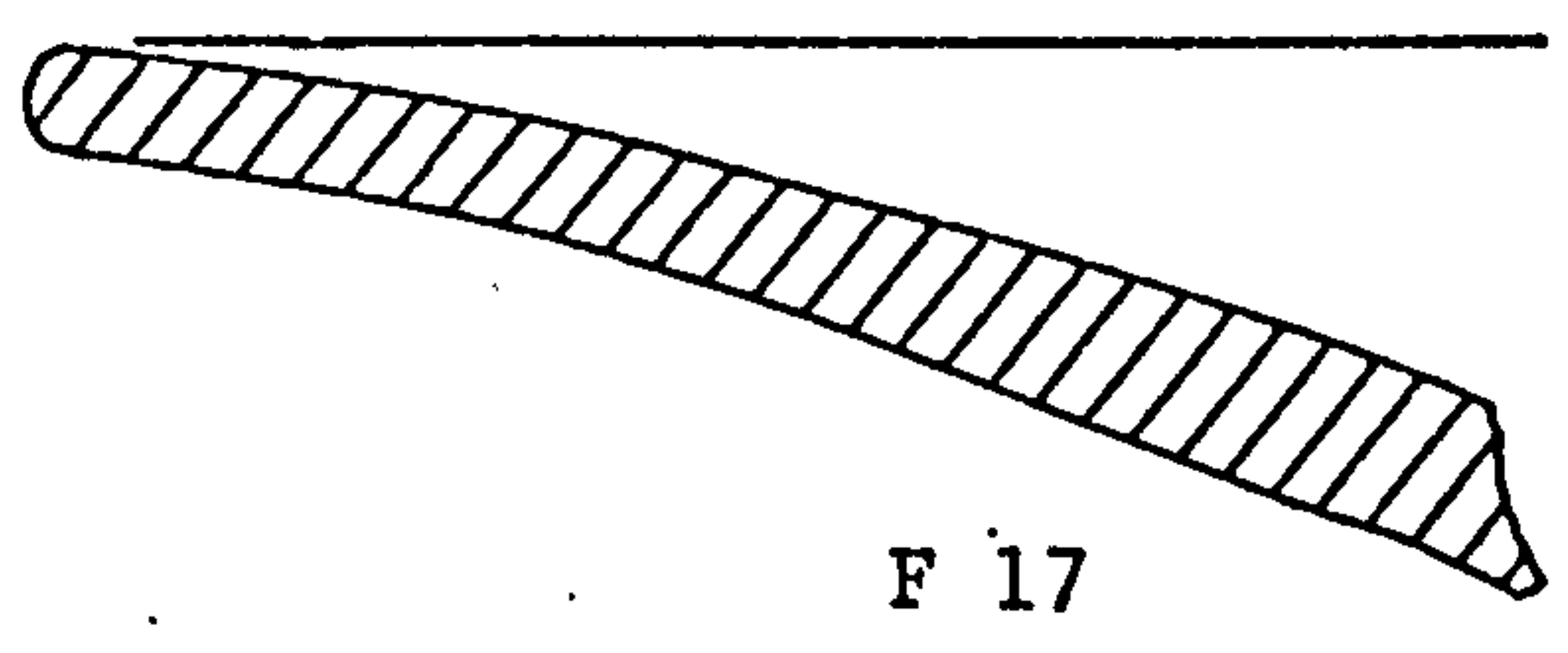

F 17

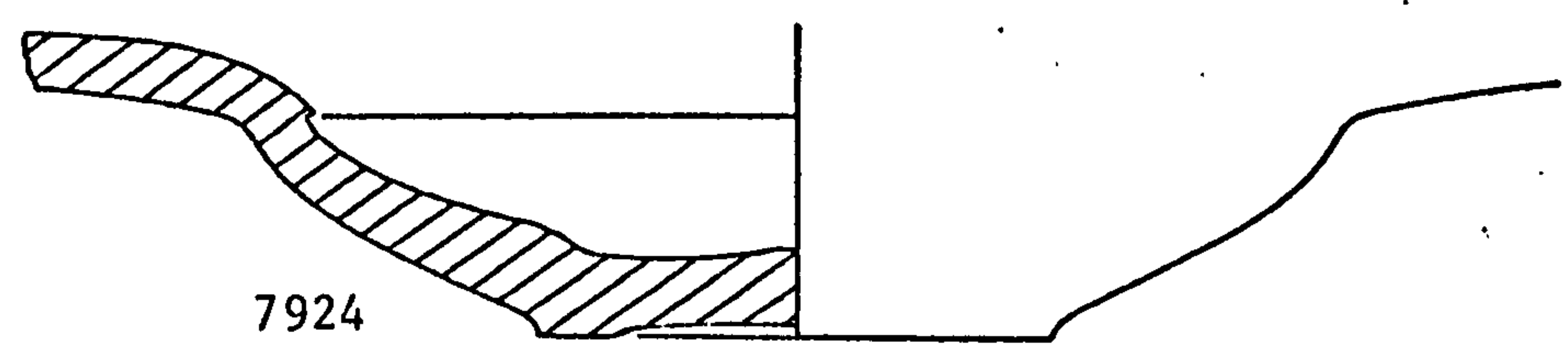

7924

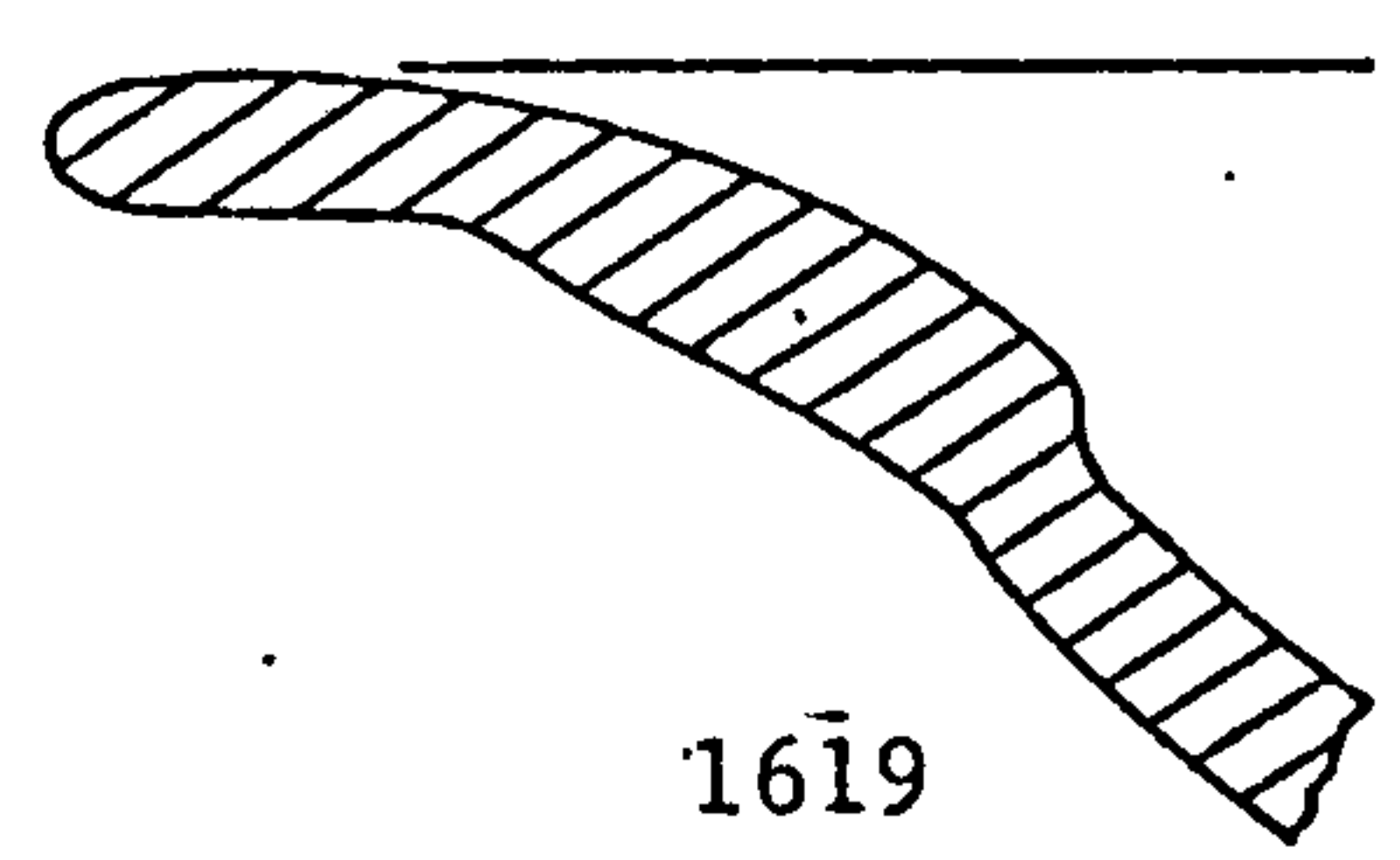

1619

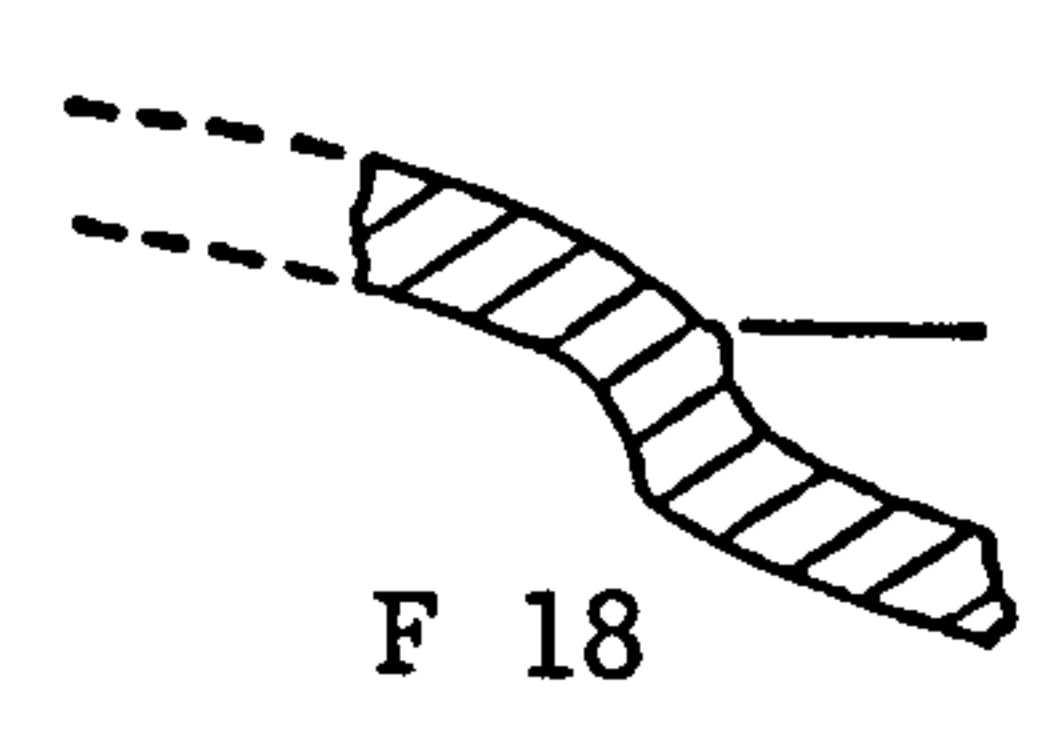

F 18

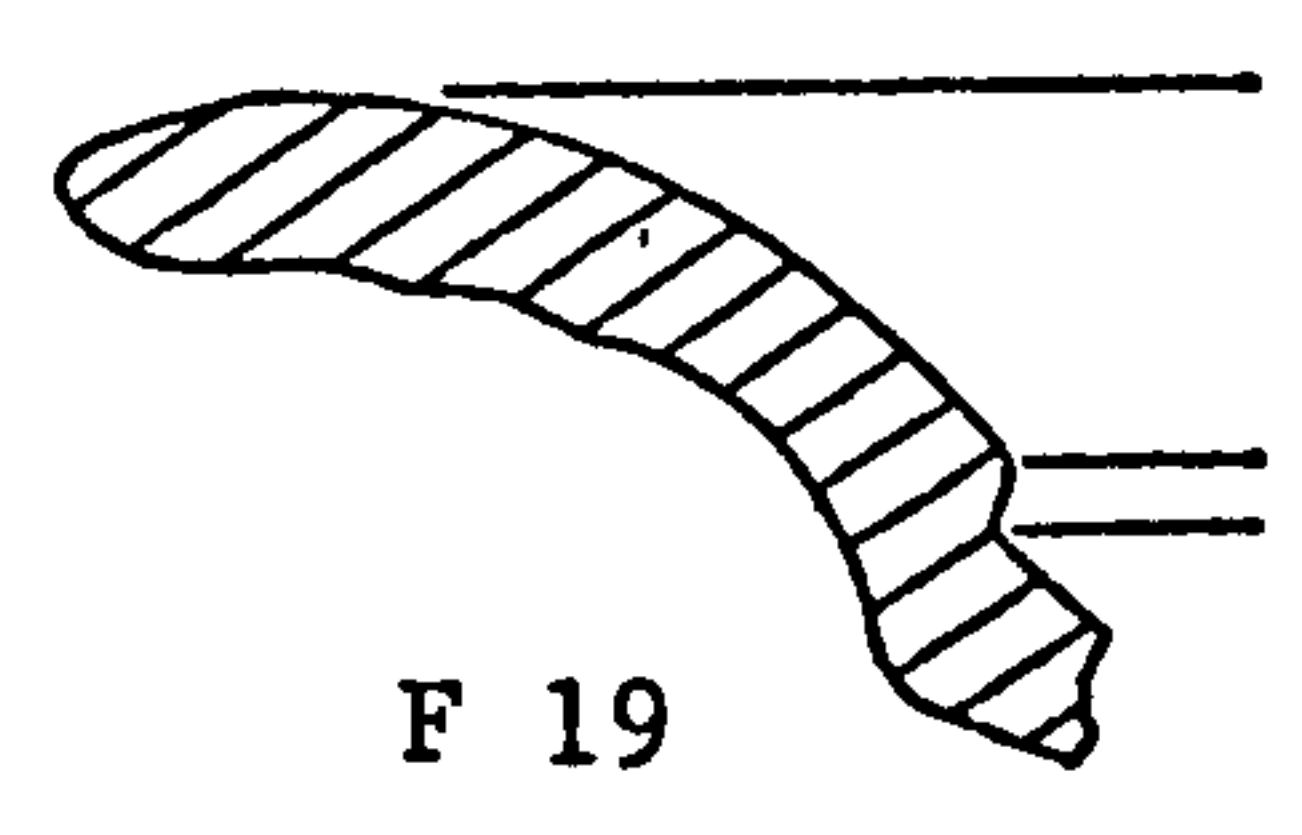

F 19

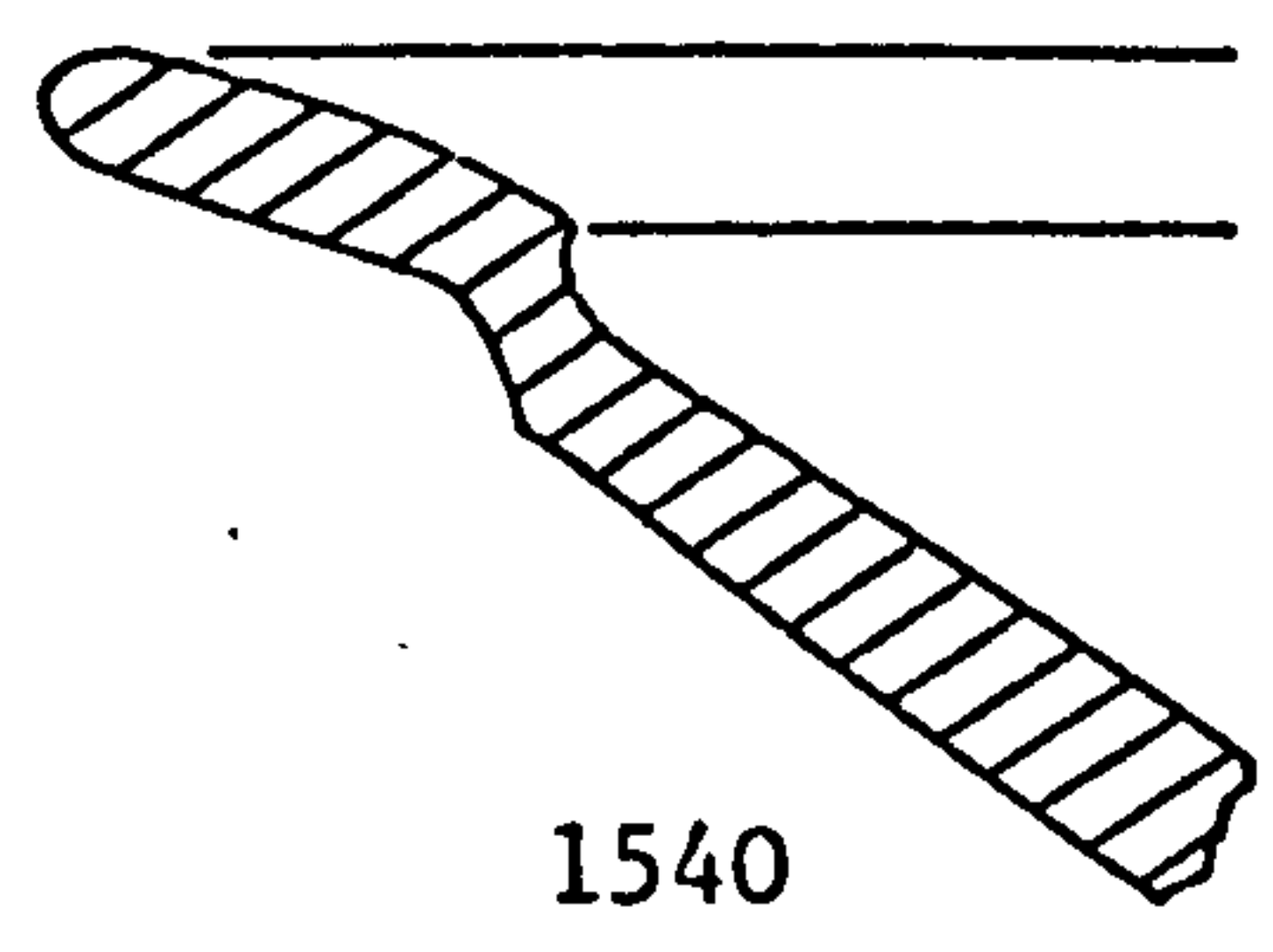

1540

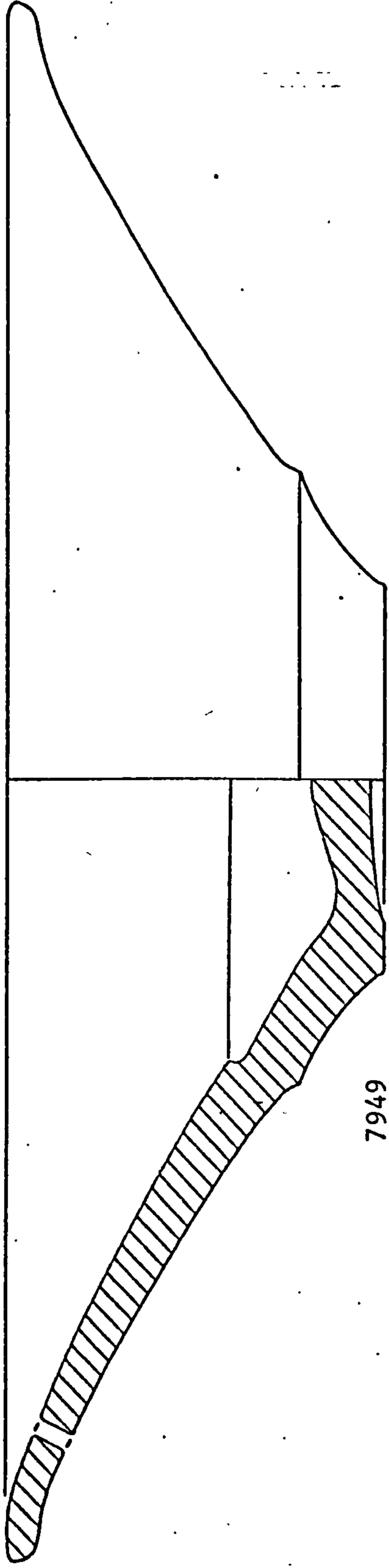

7949

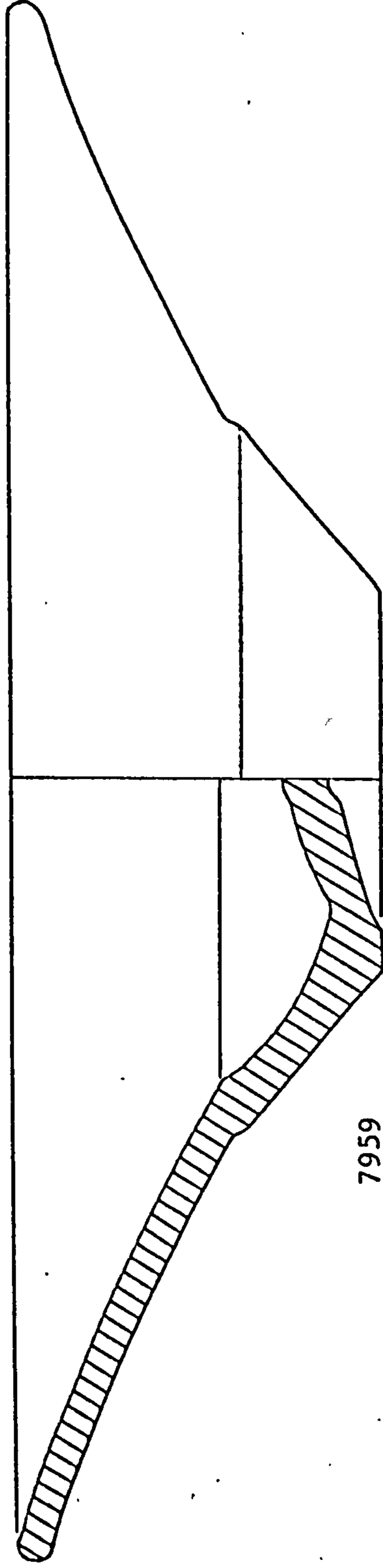

7959

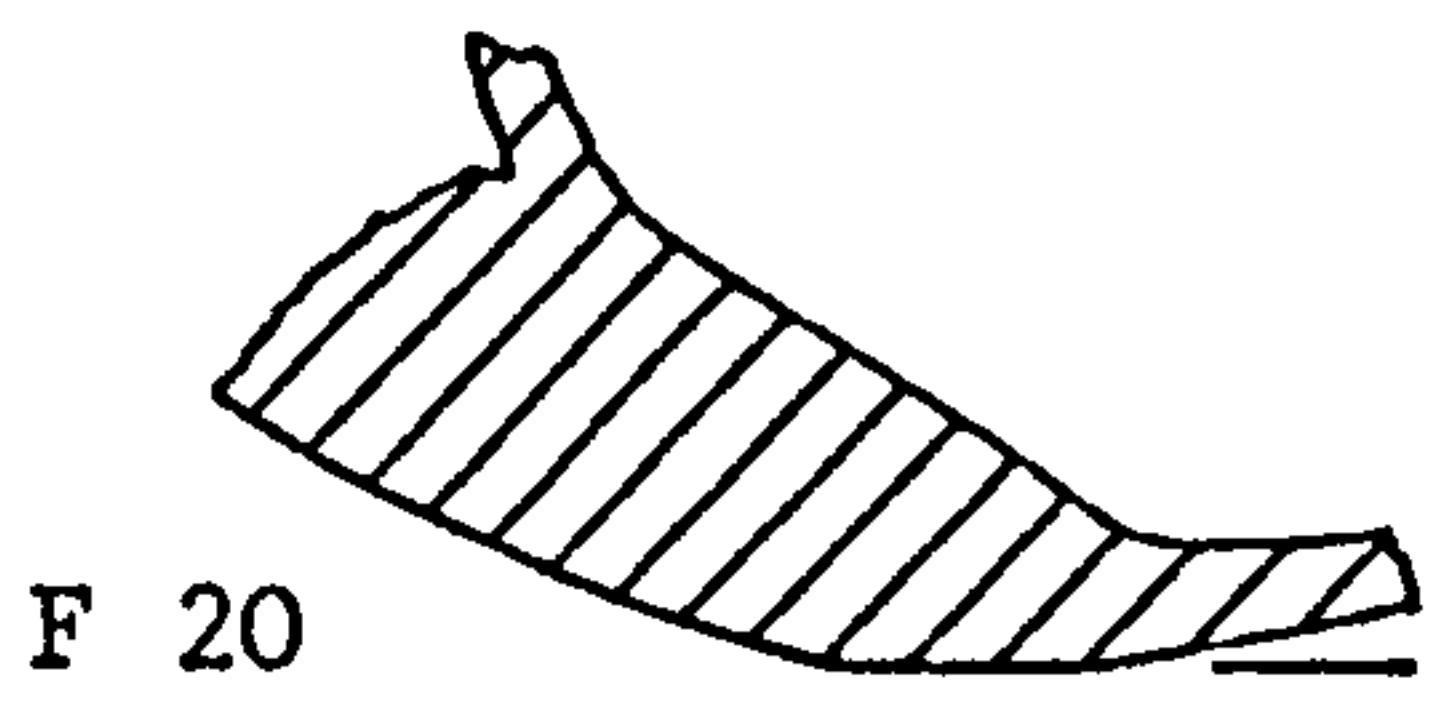
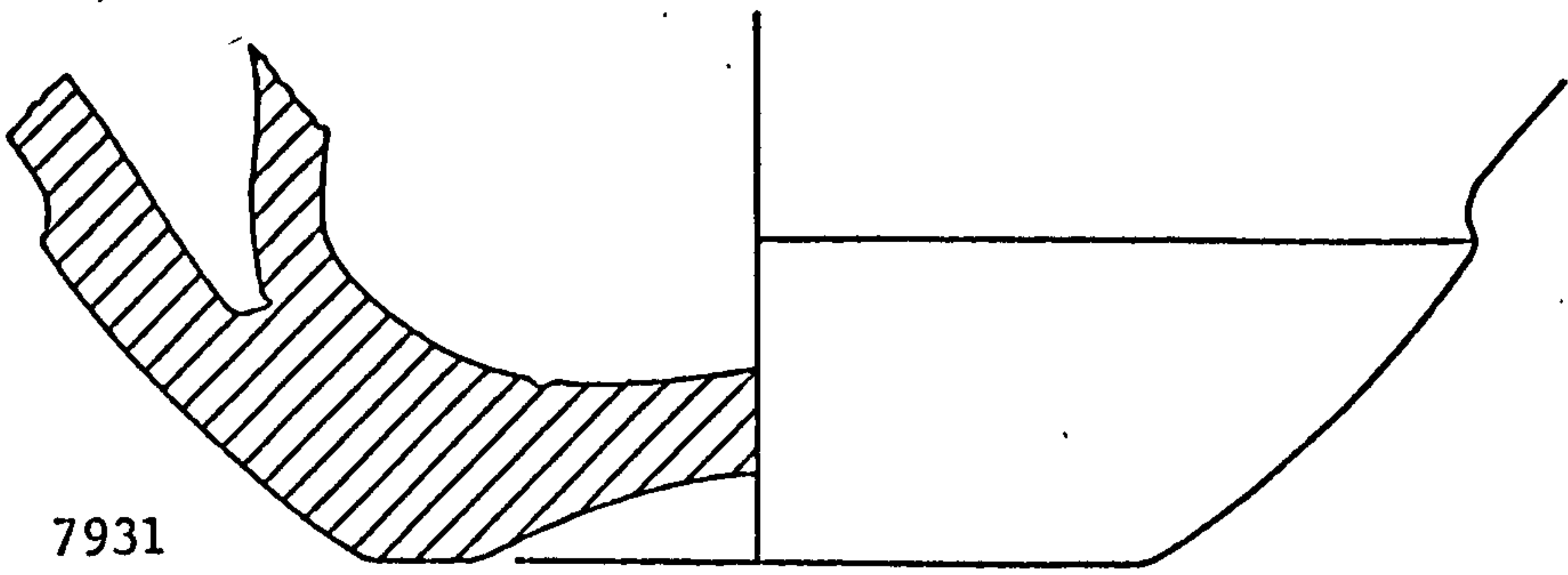
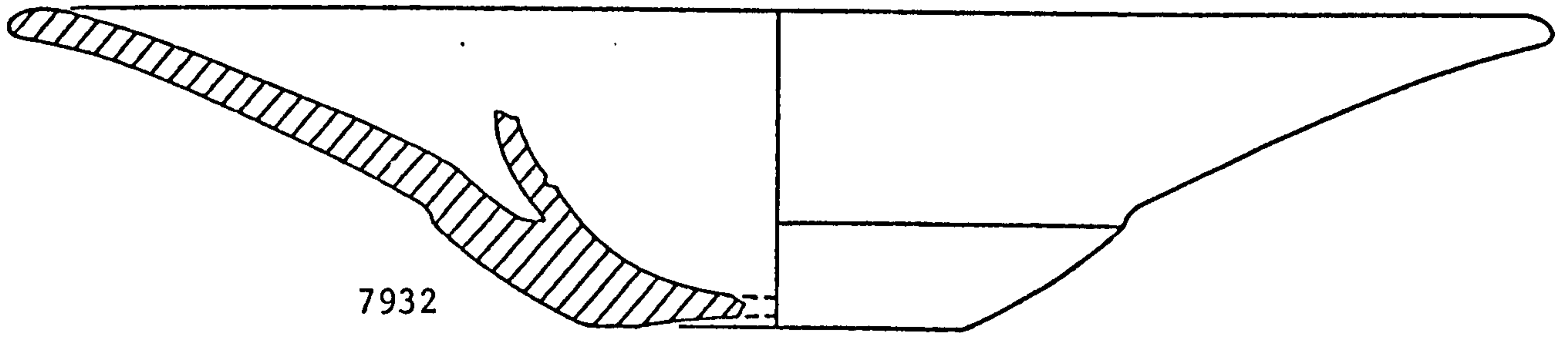

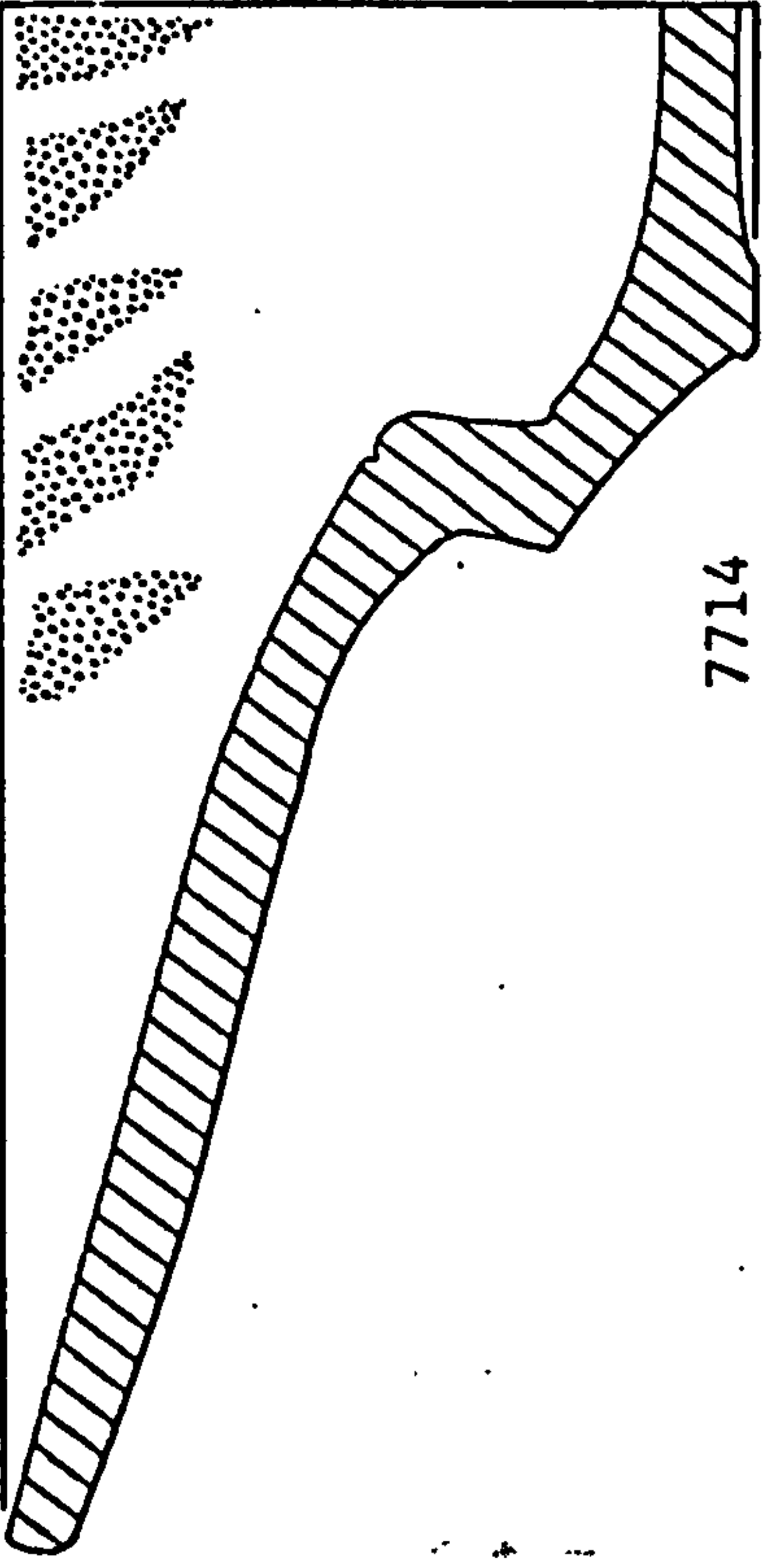

7714

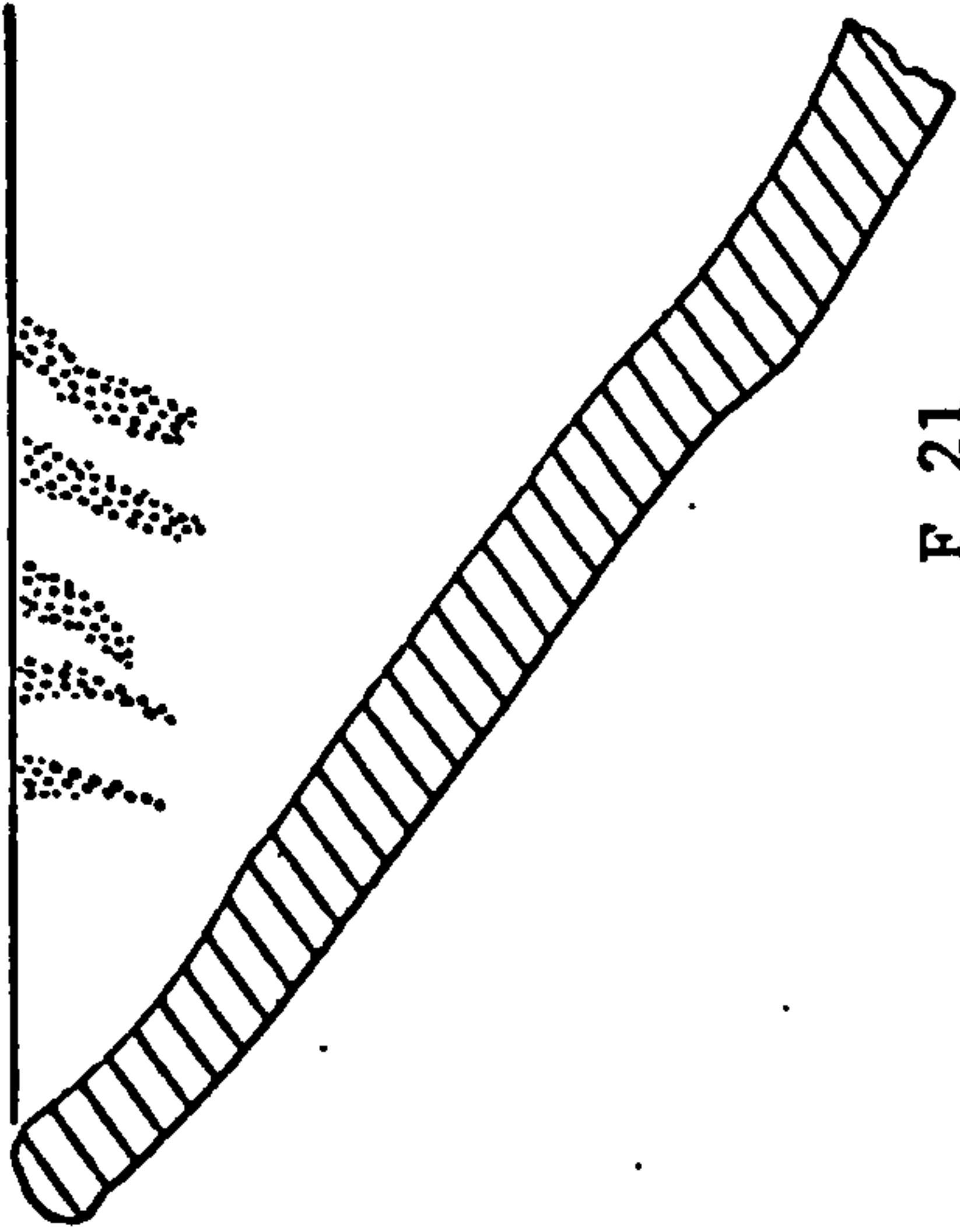

F 21

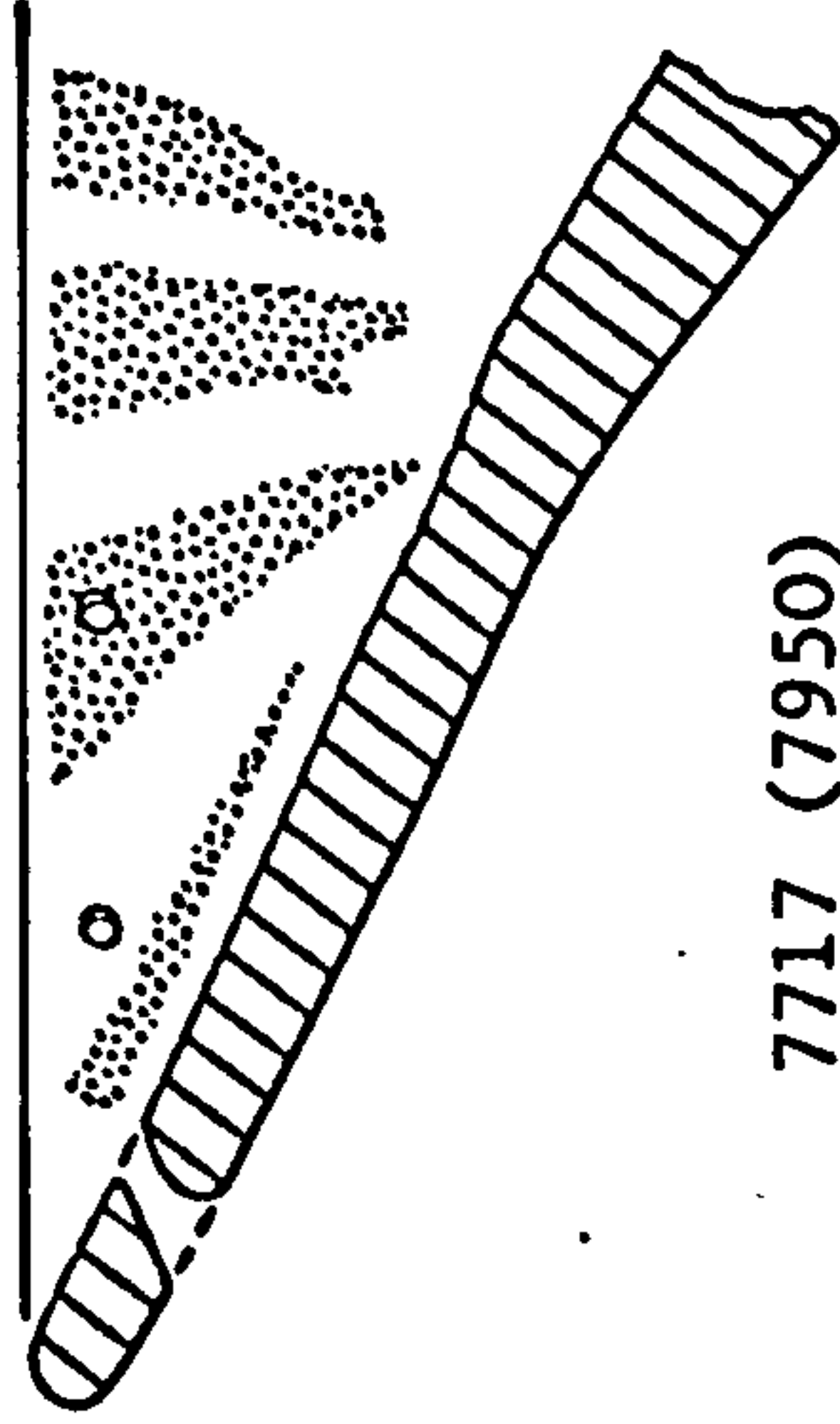

7717 (7950)

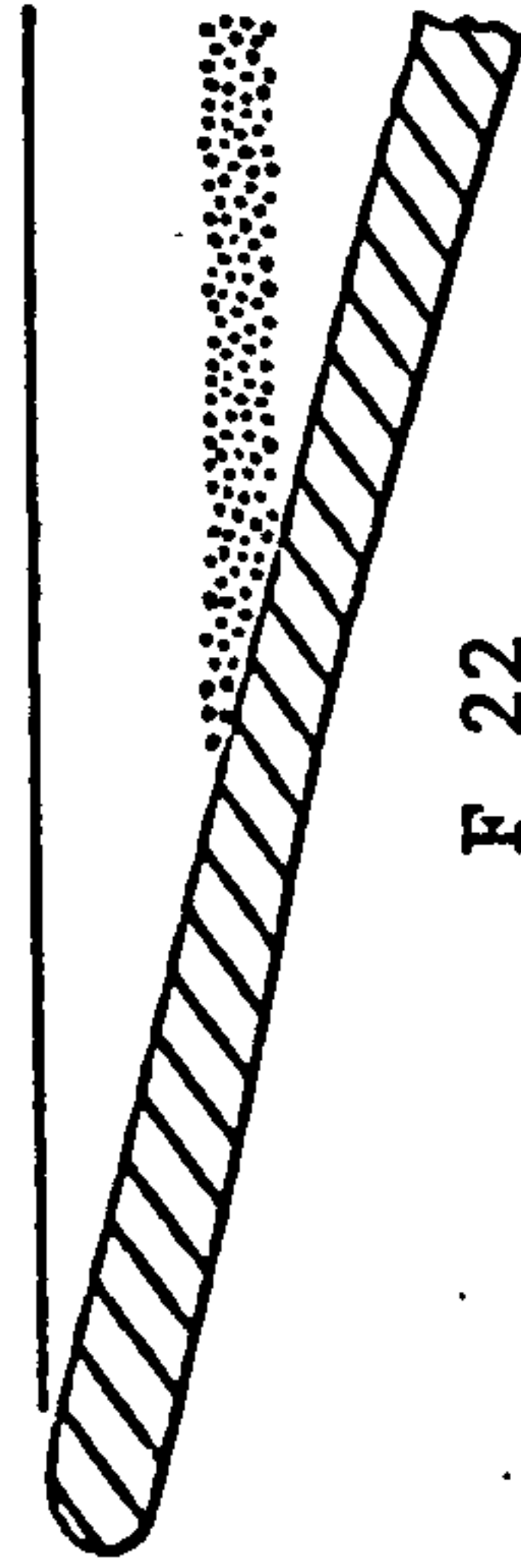

F 22

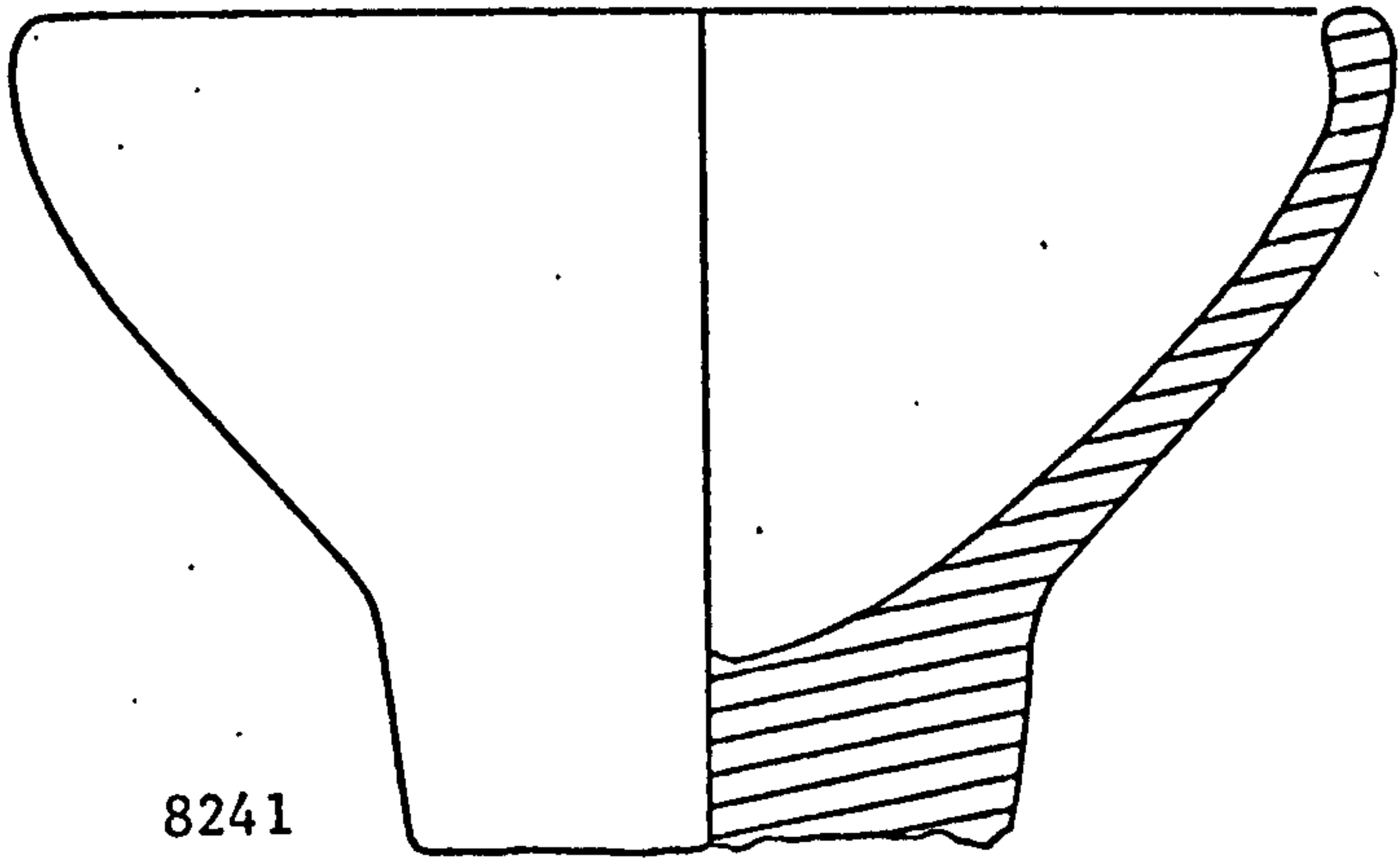

8241

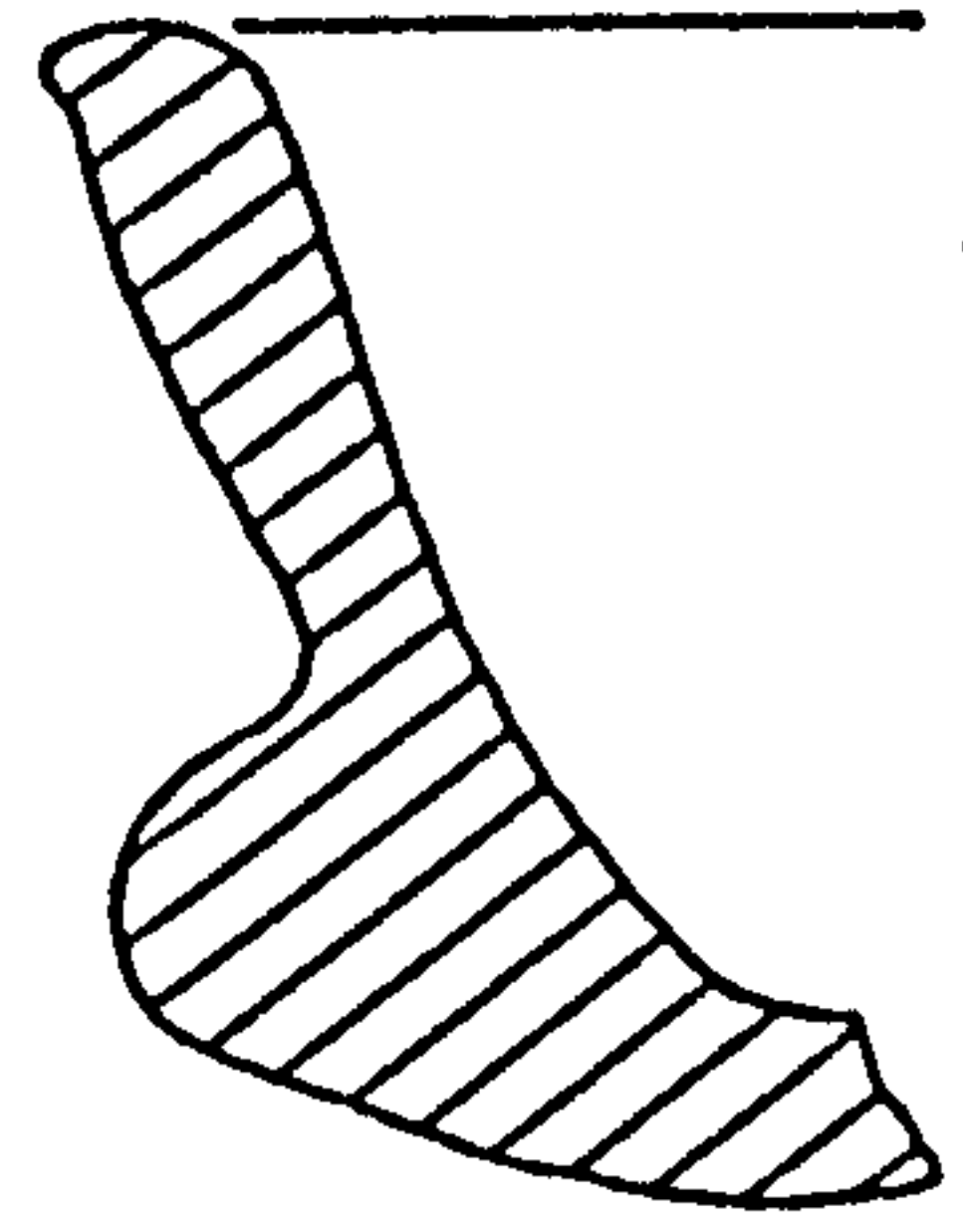

F 23

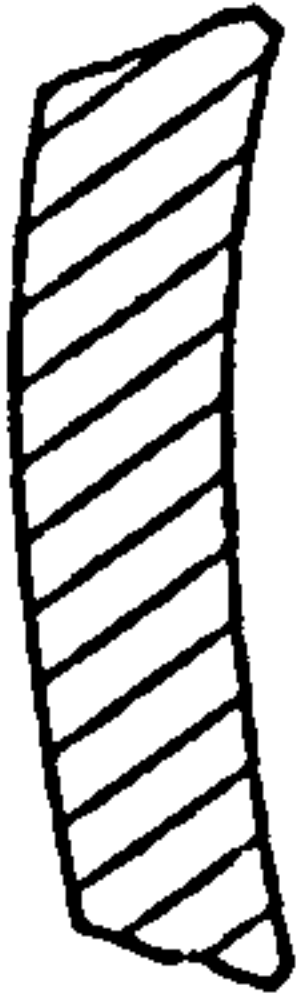

1713

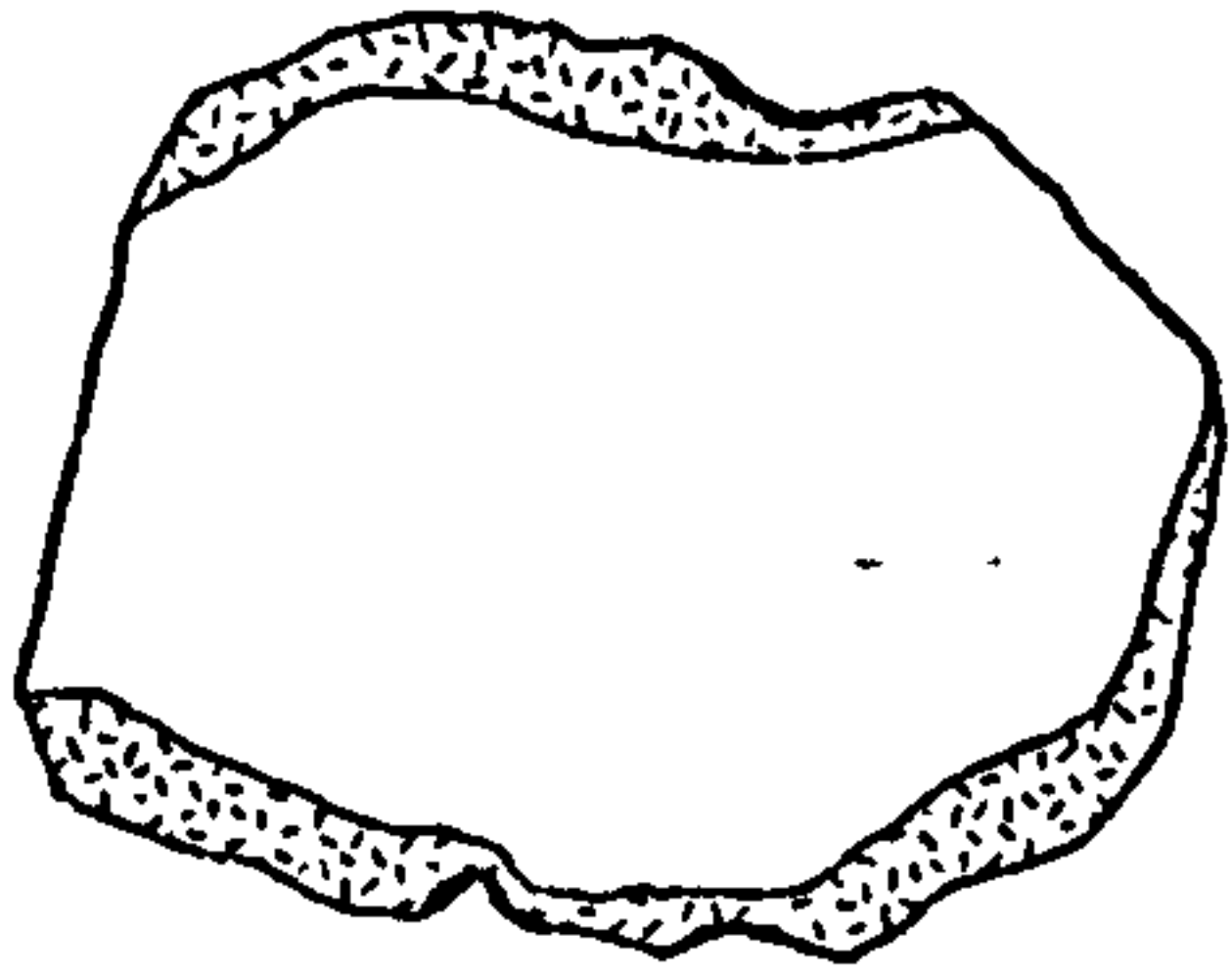

7983

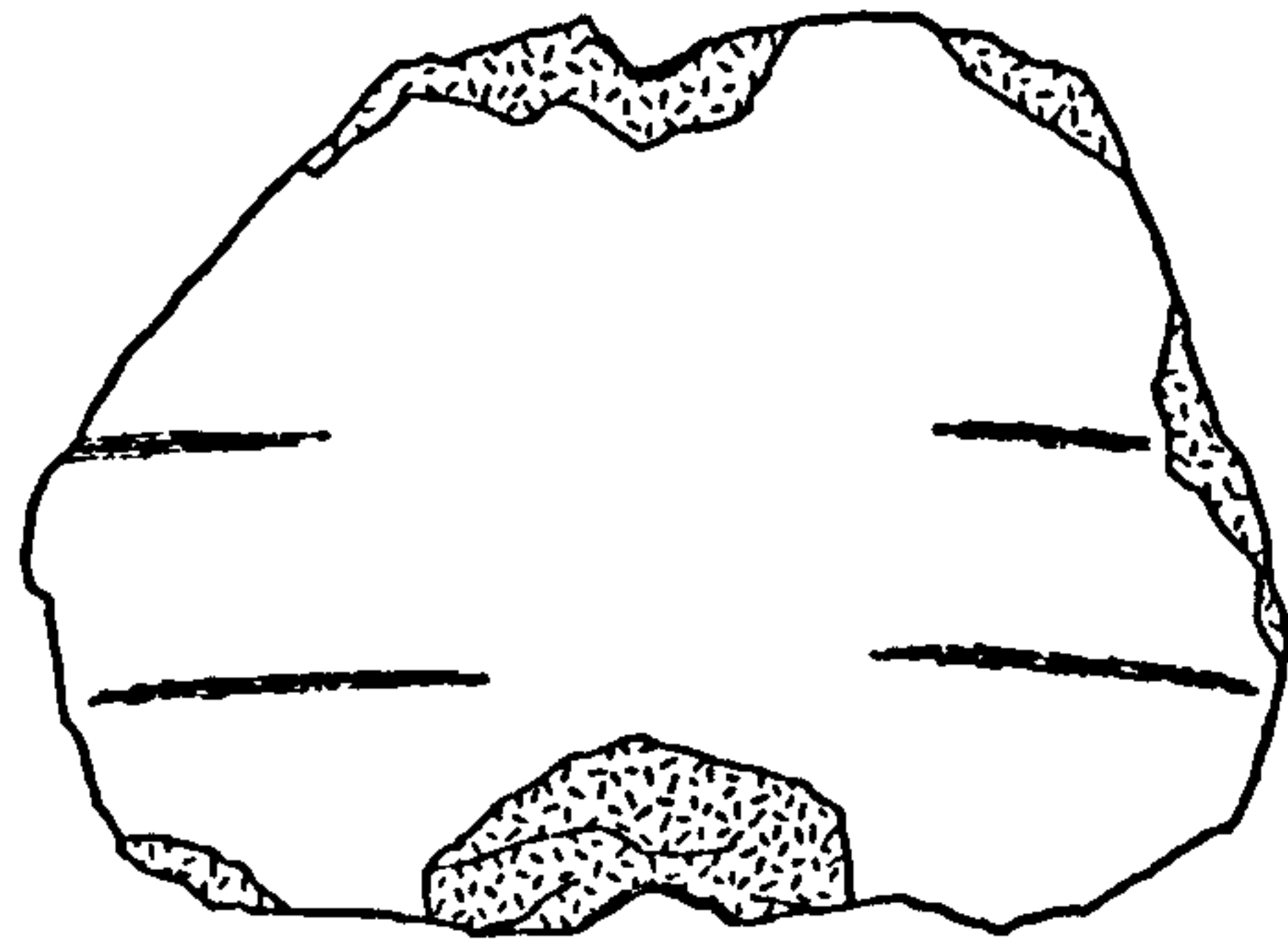
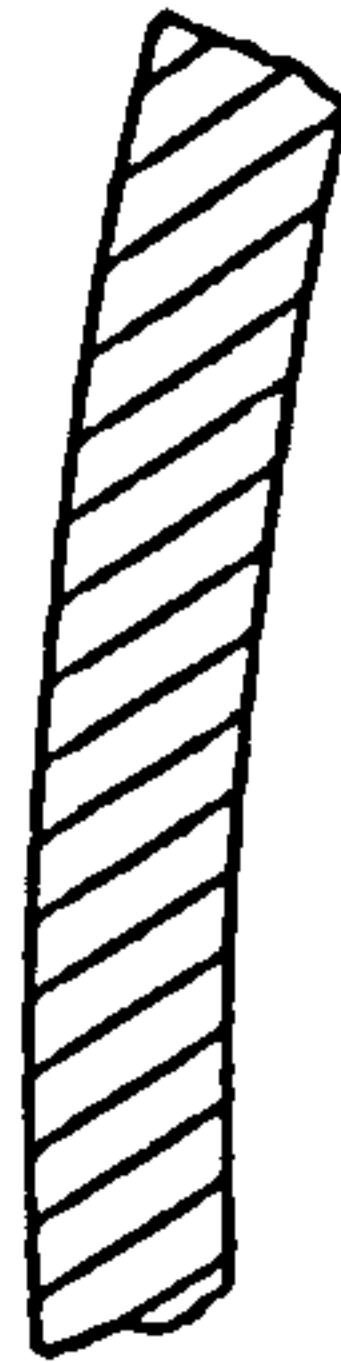

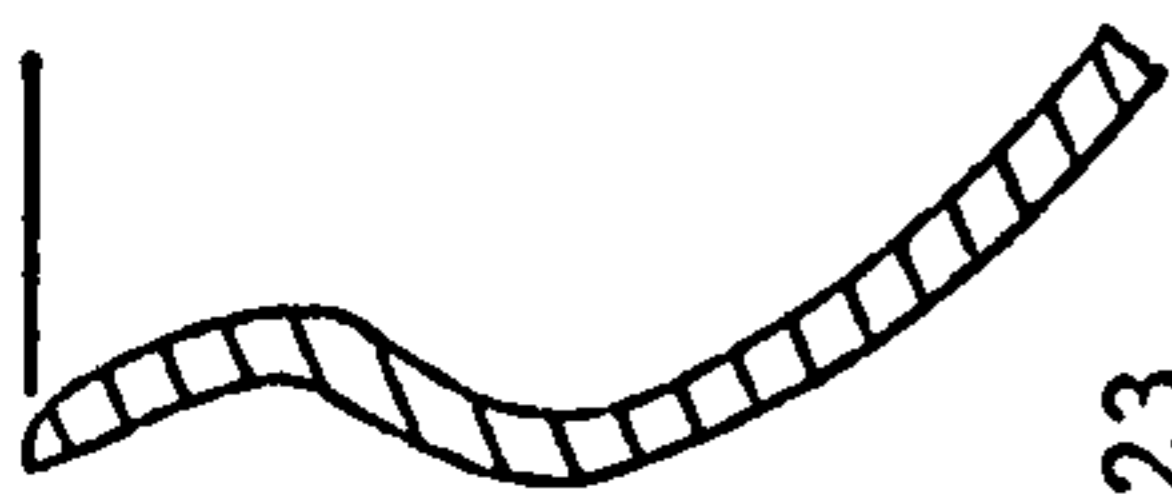
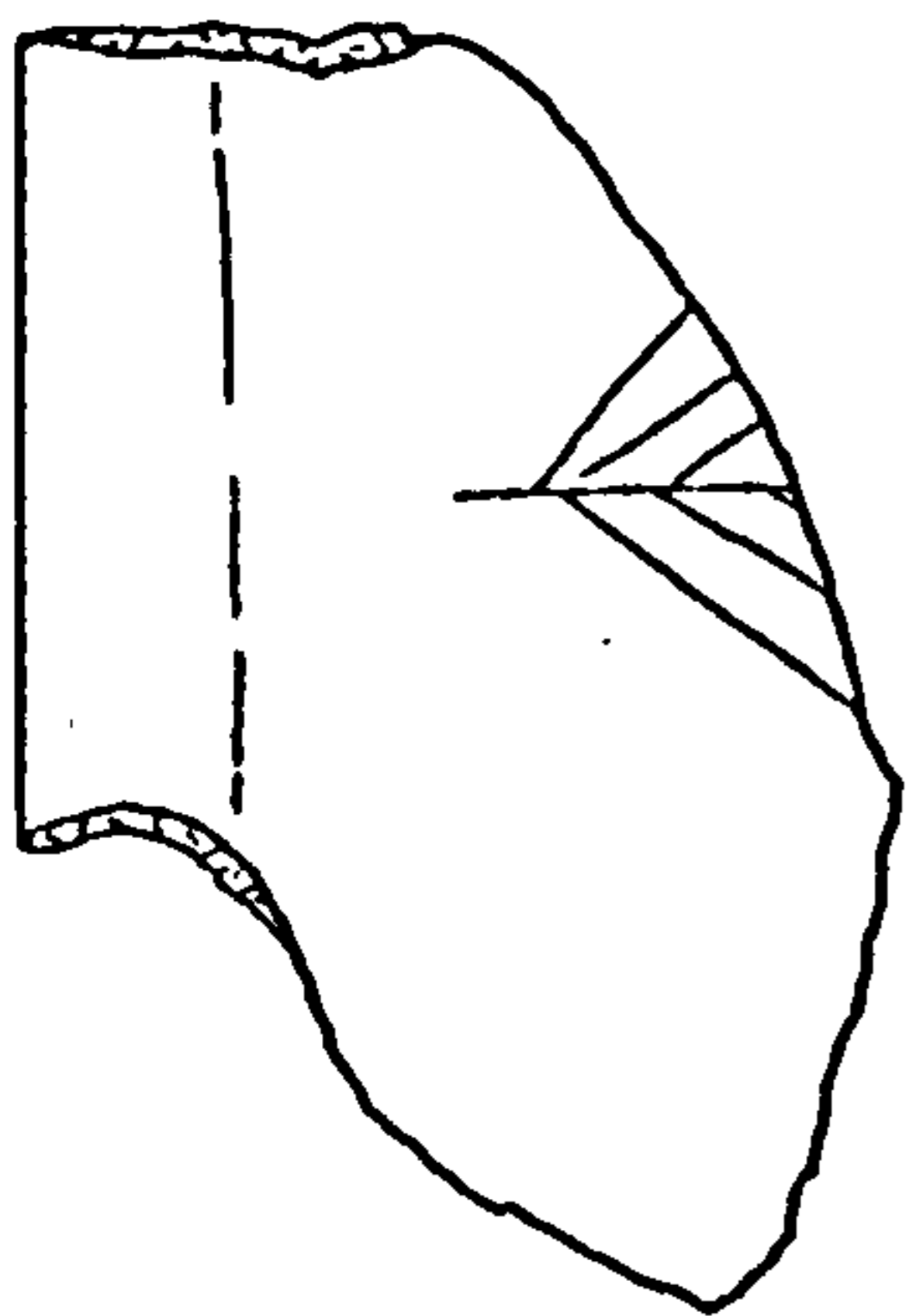

F 23

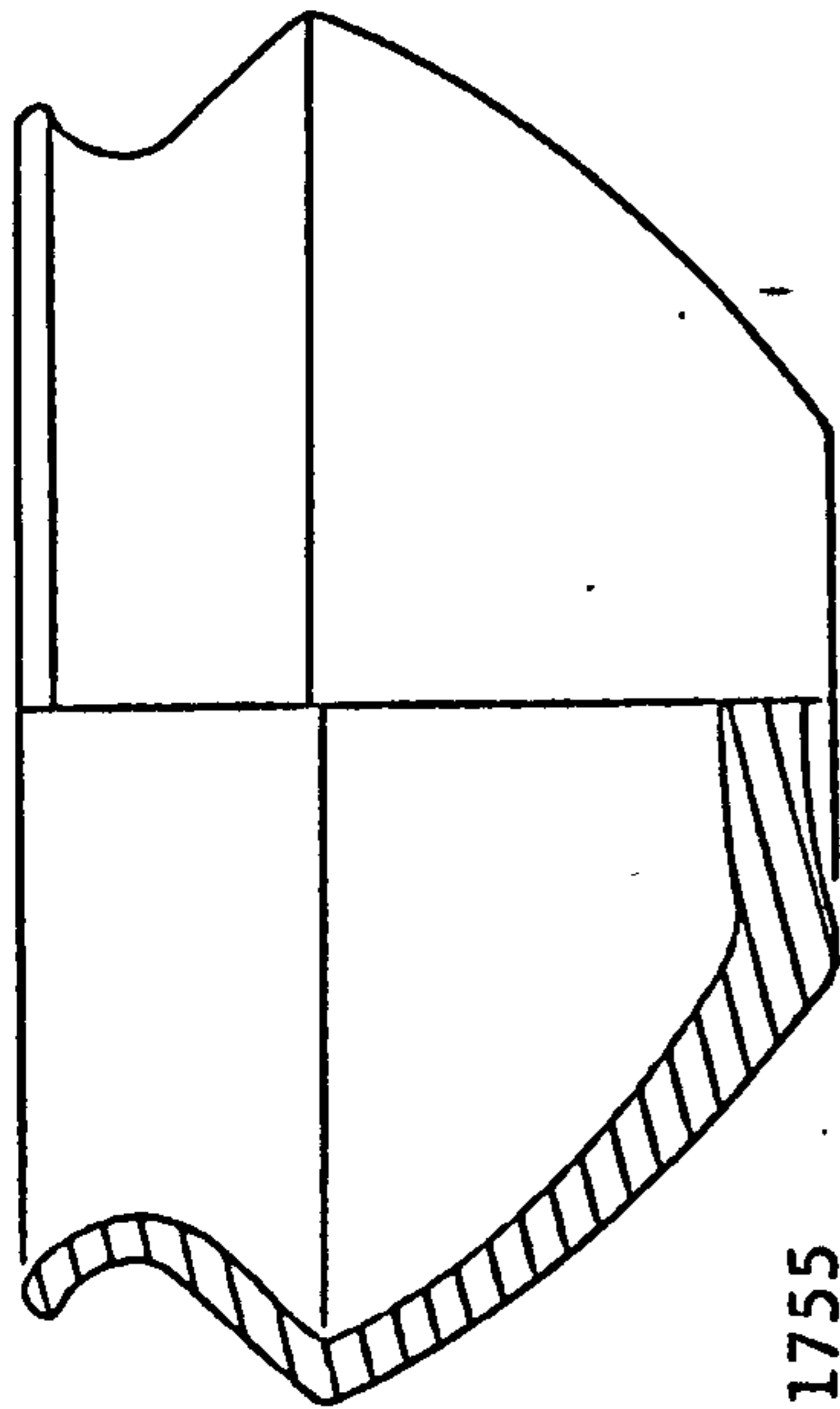

1755

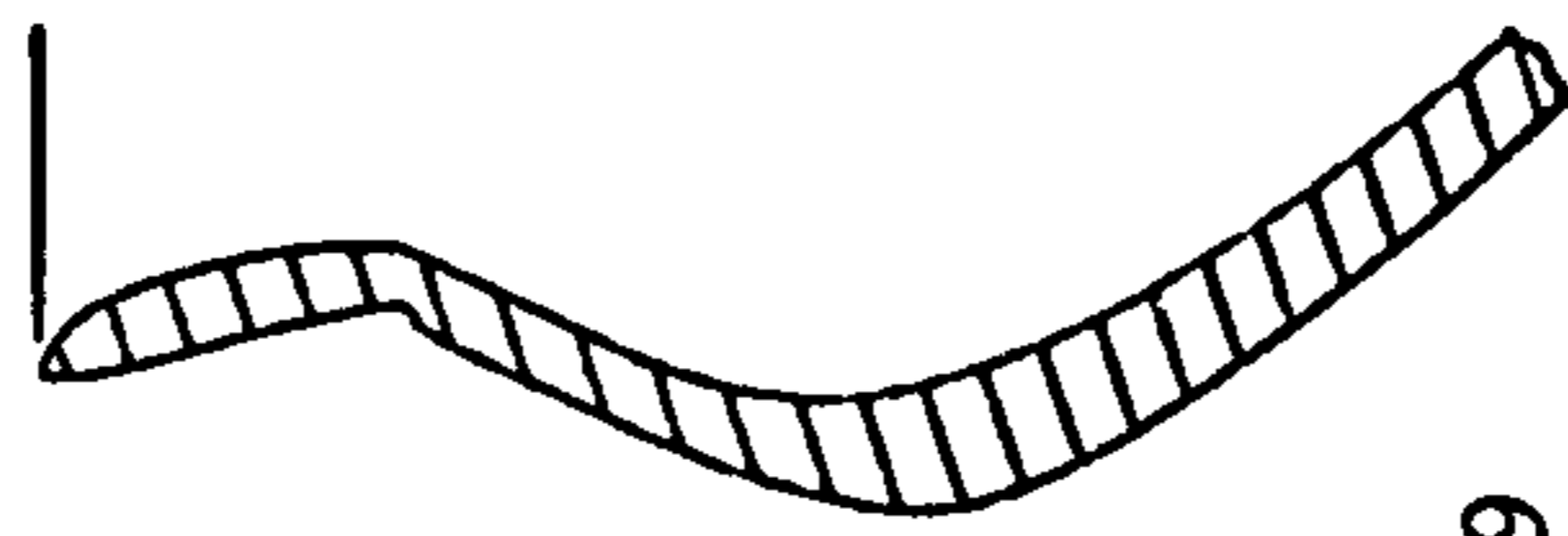

1639

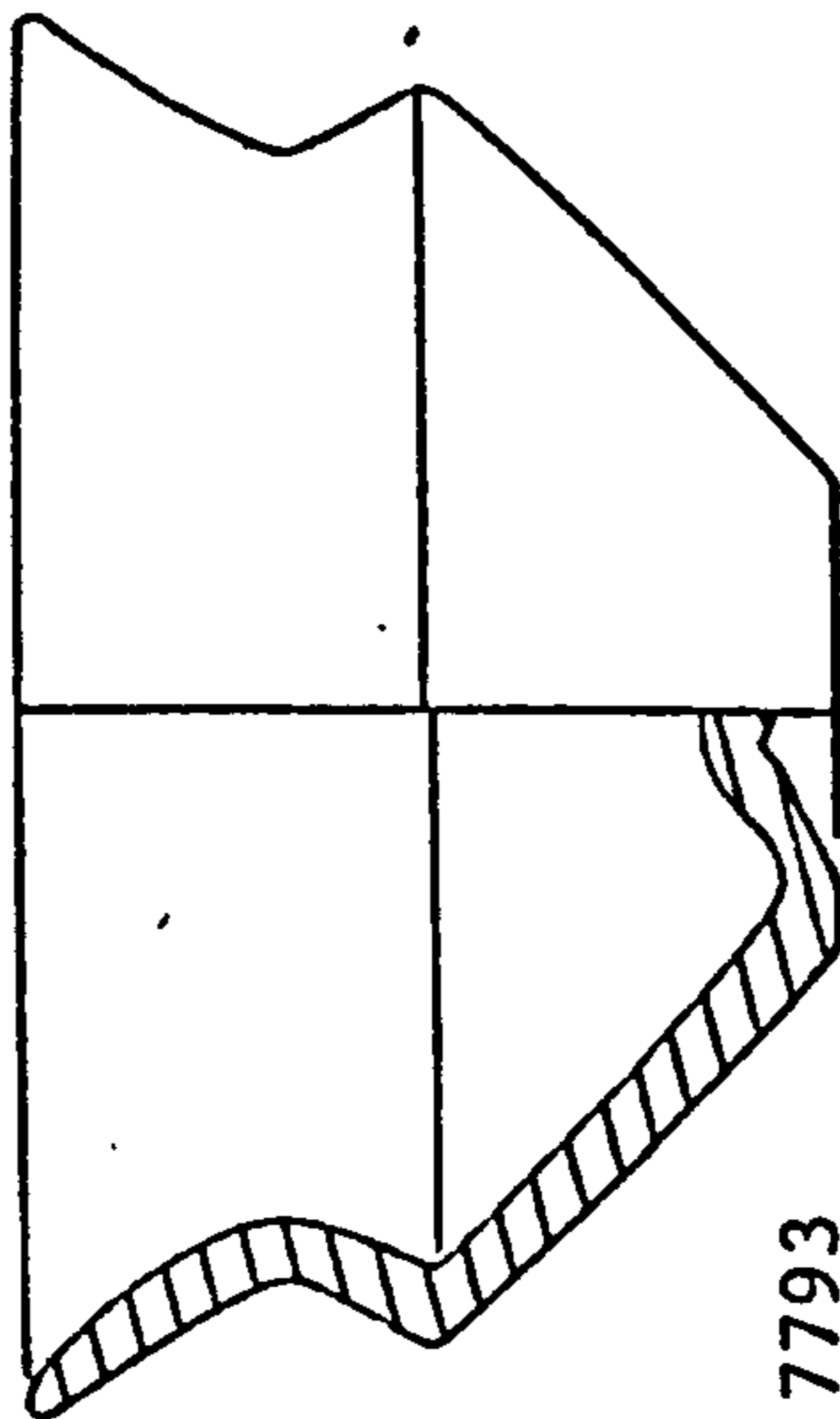

7793

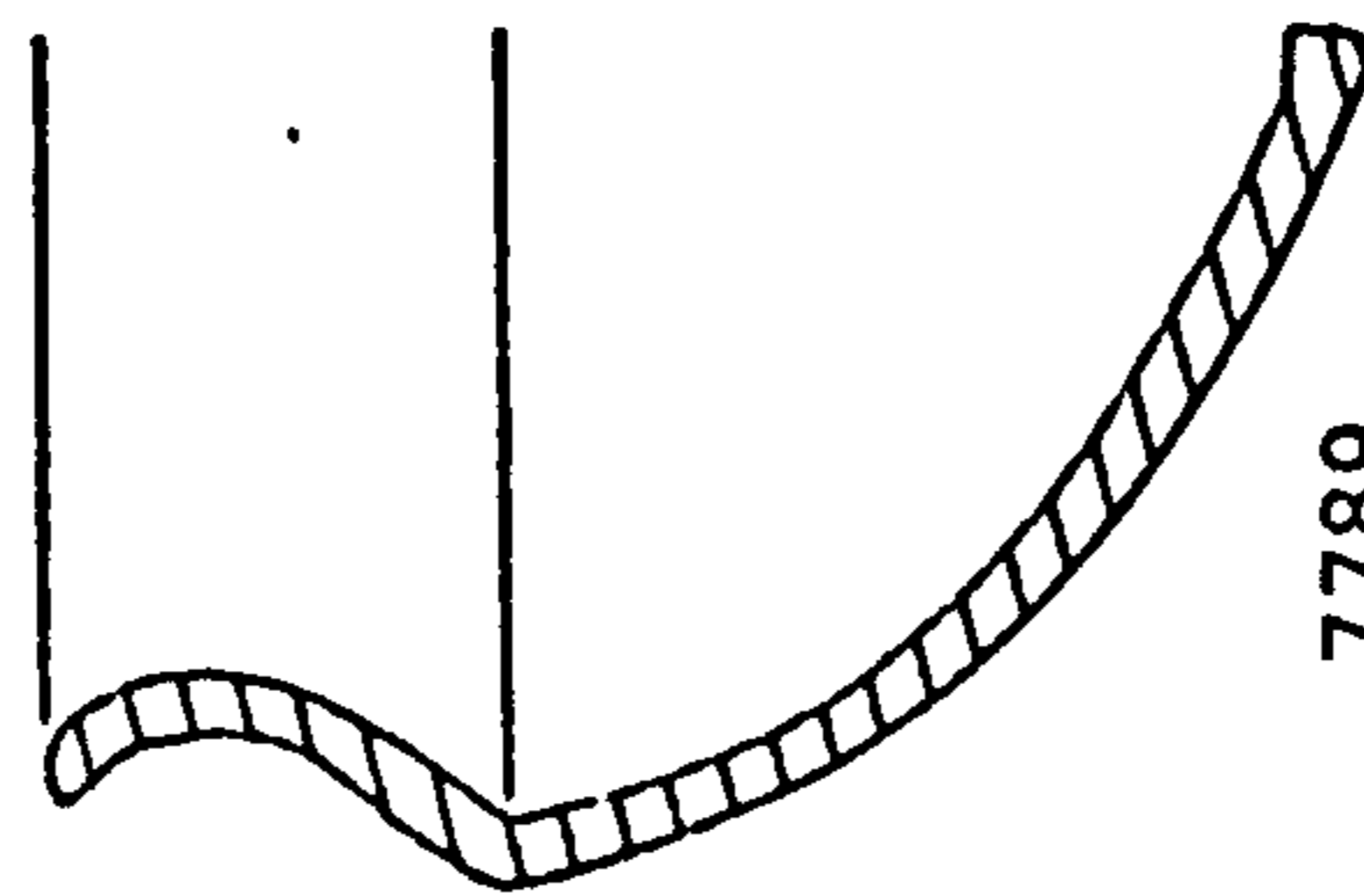

7789



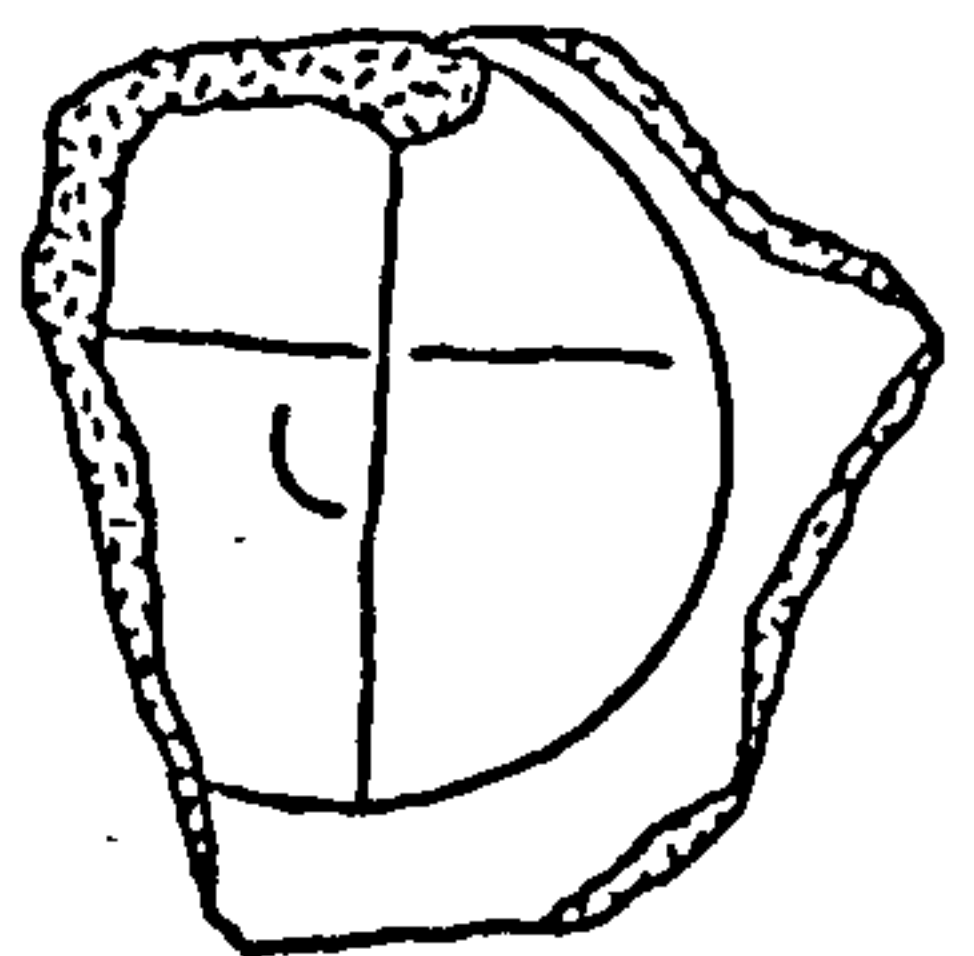
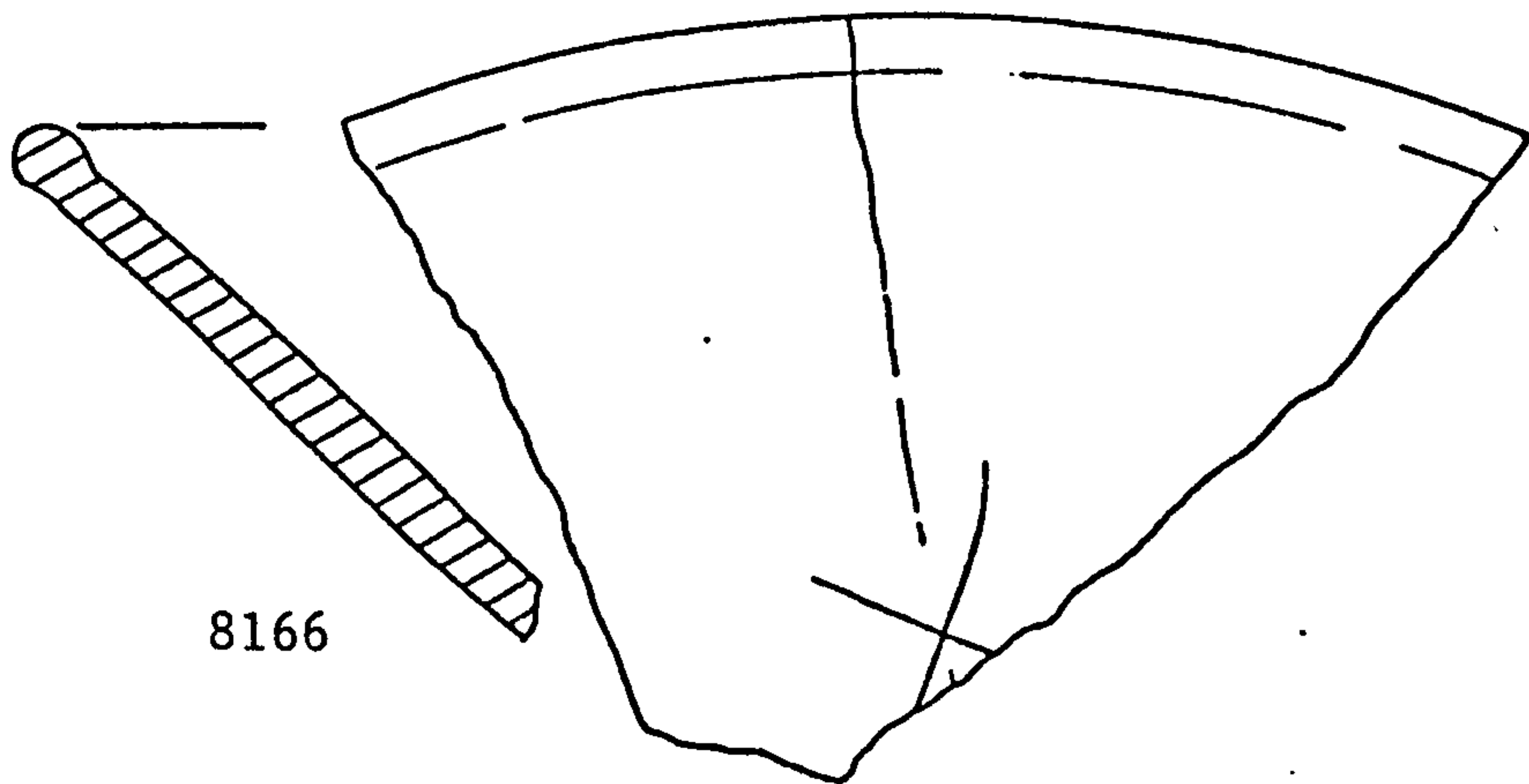
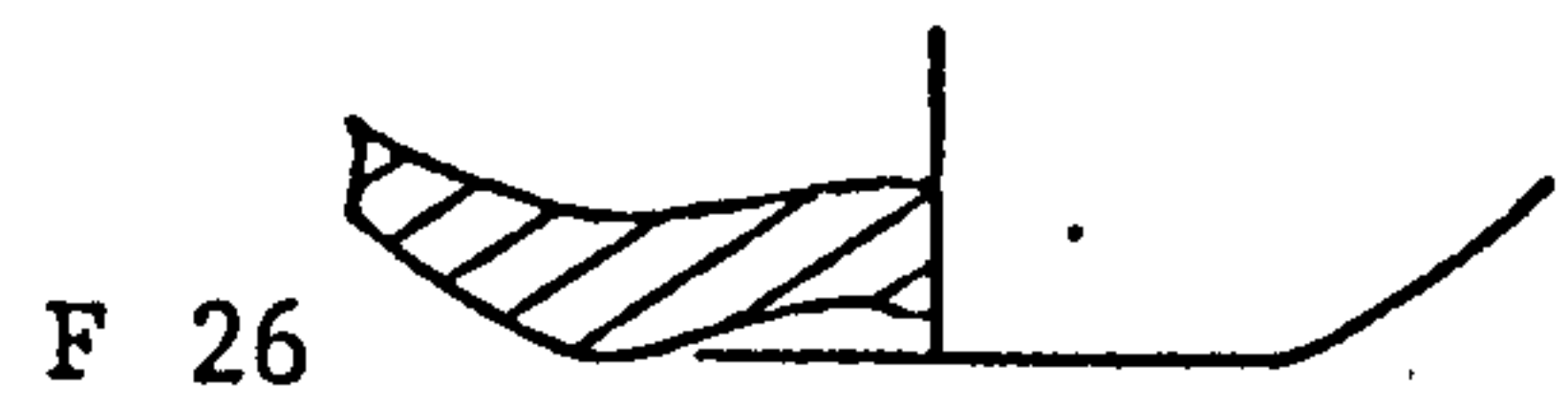
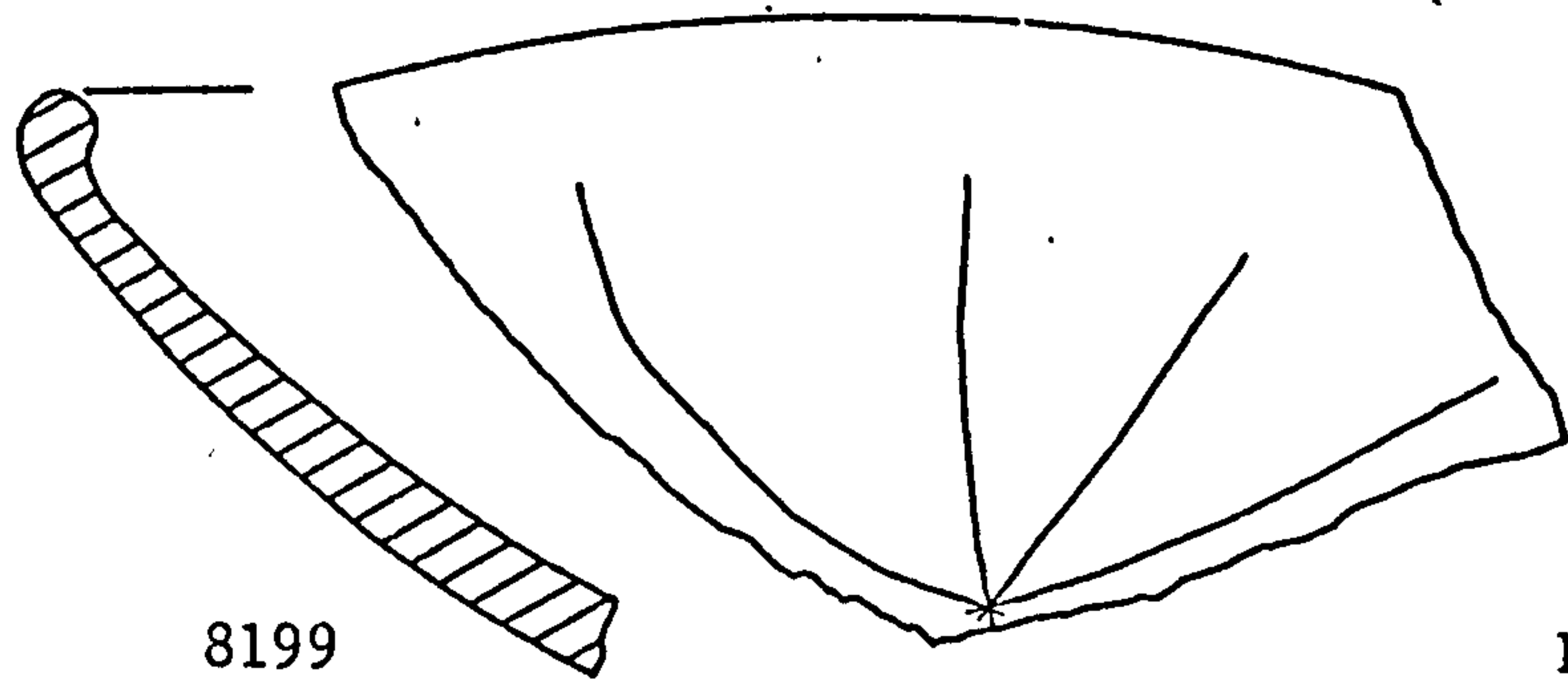
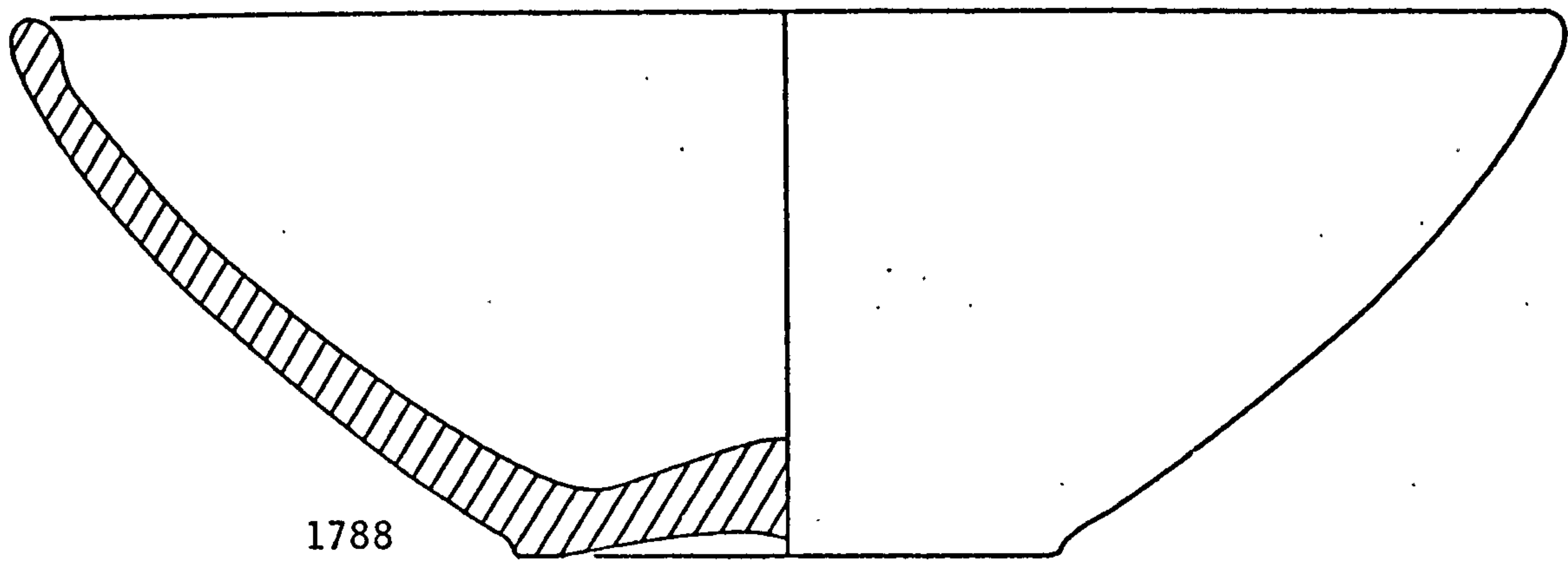
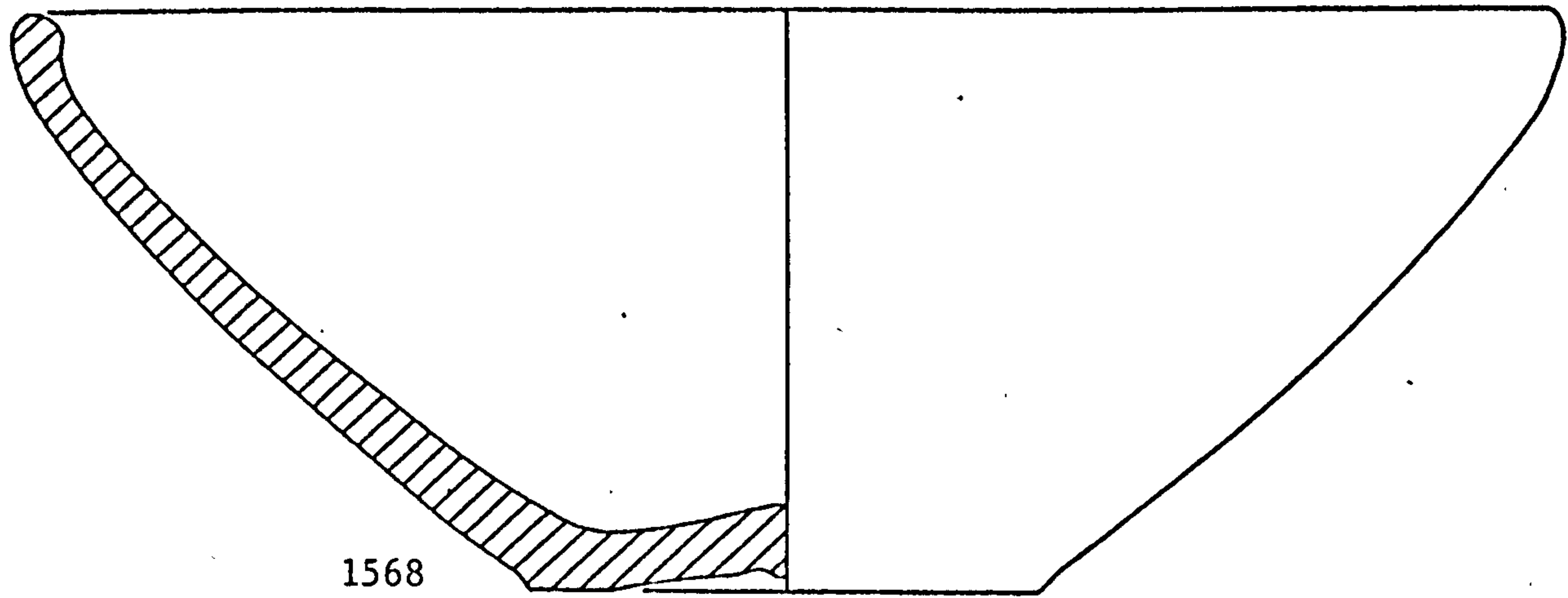

10 cm

0

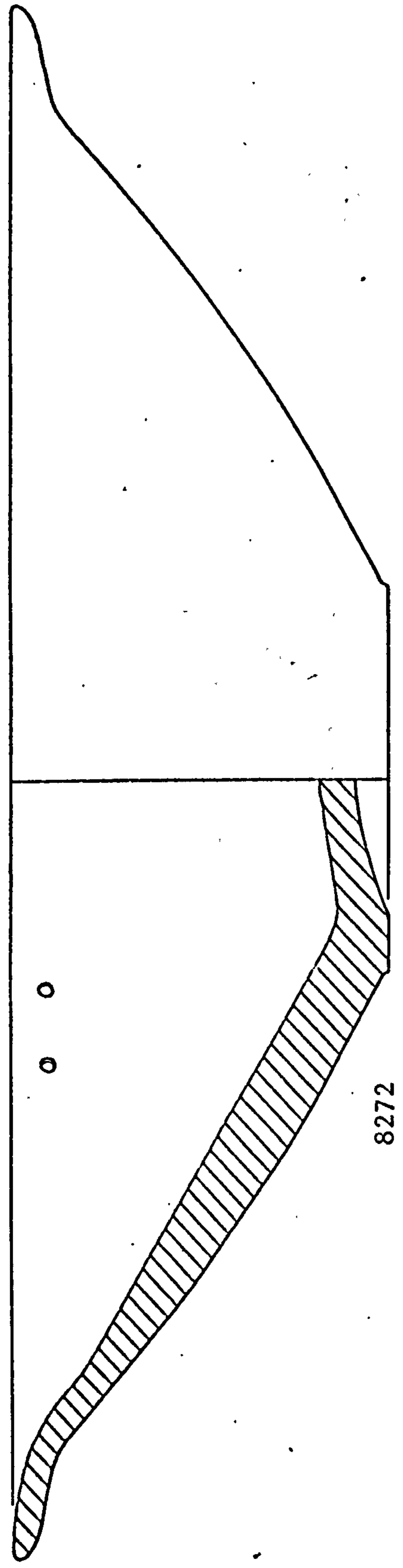

8272

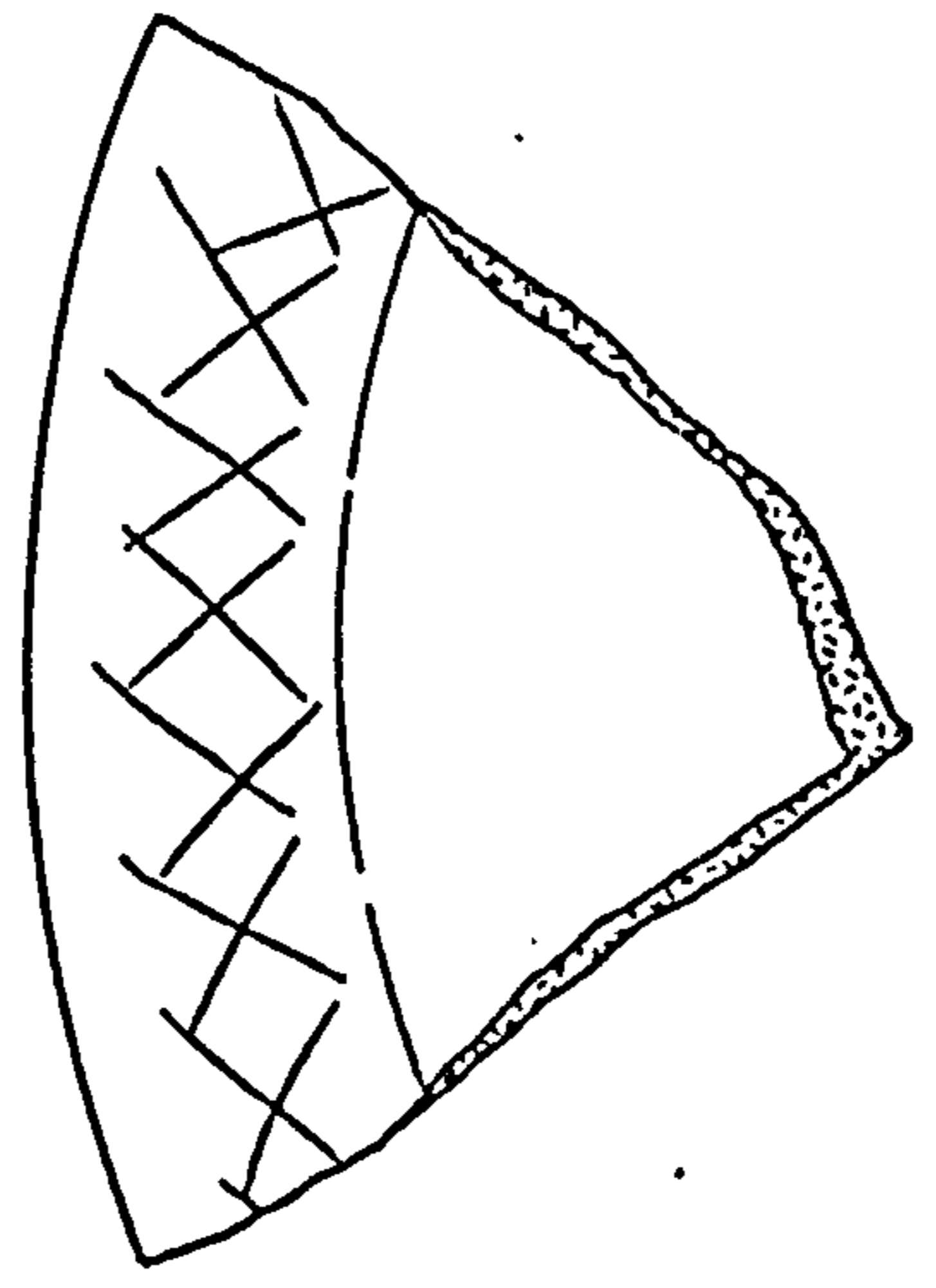

4088

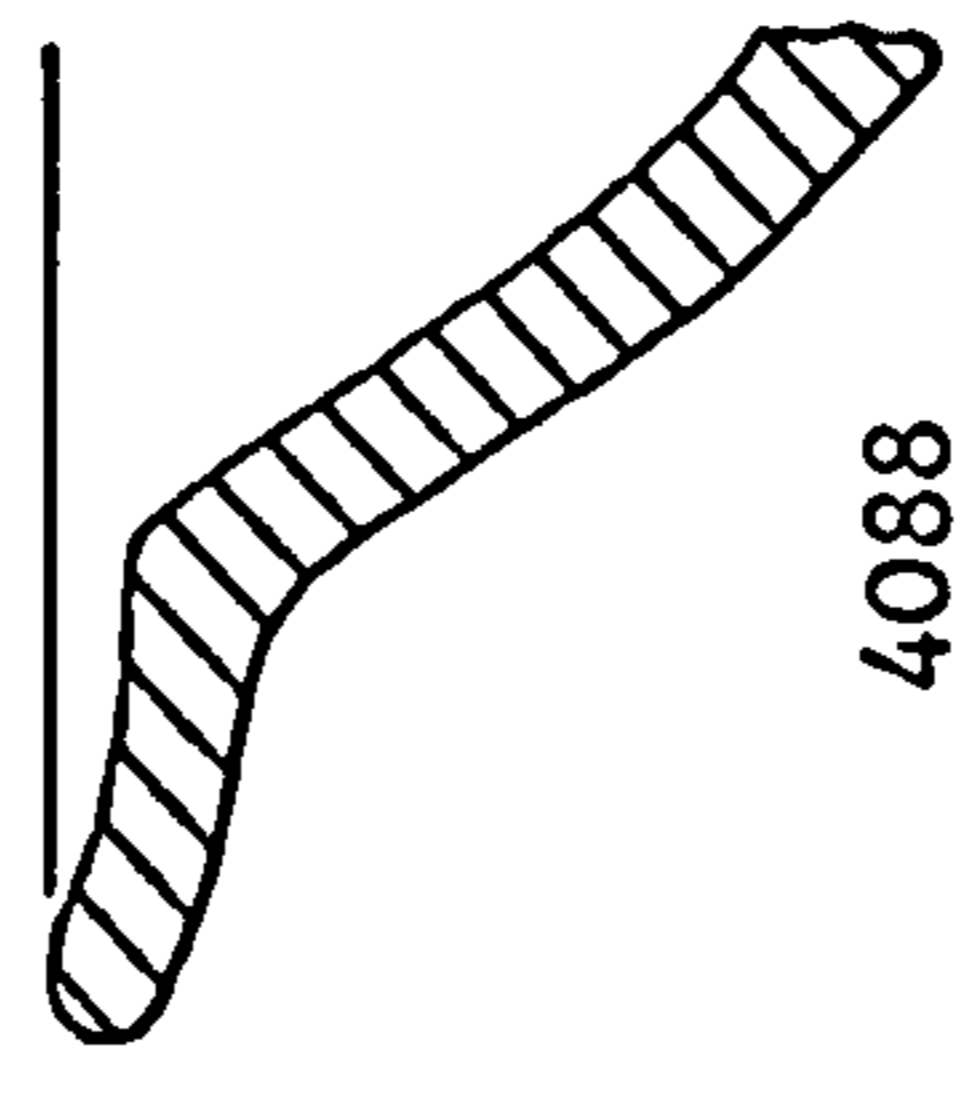

8148

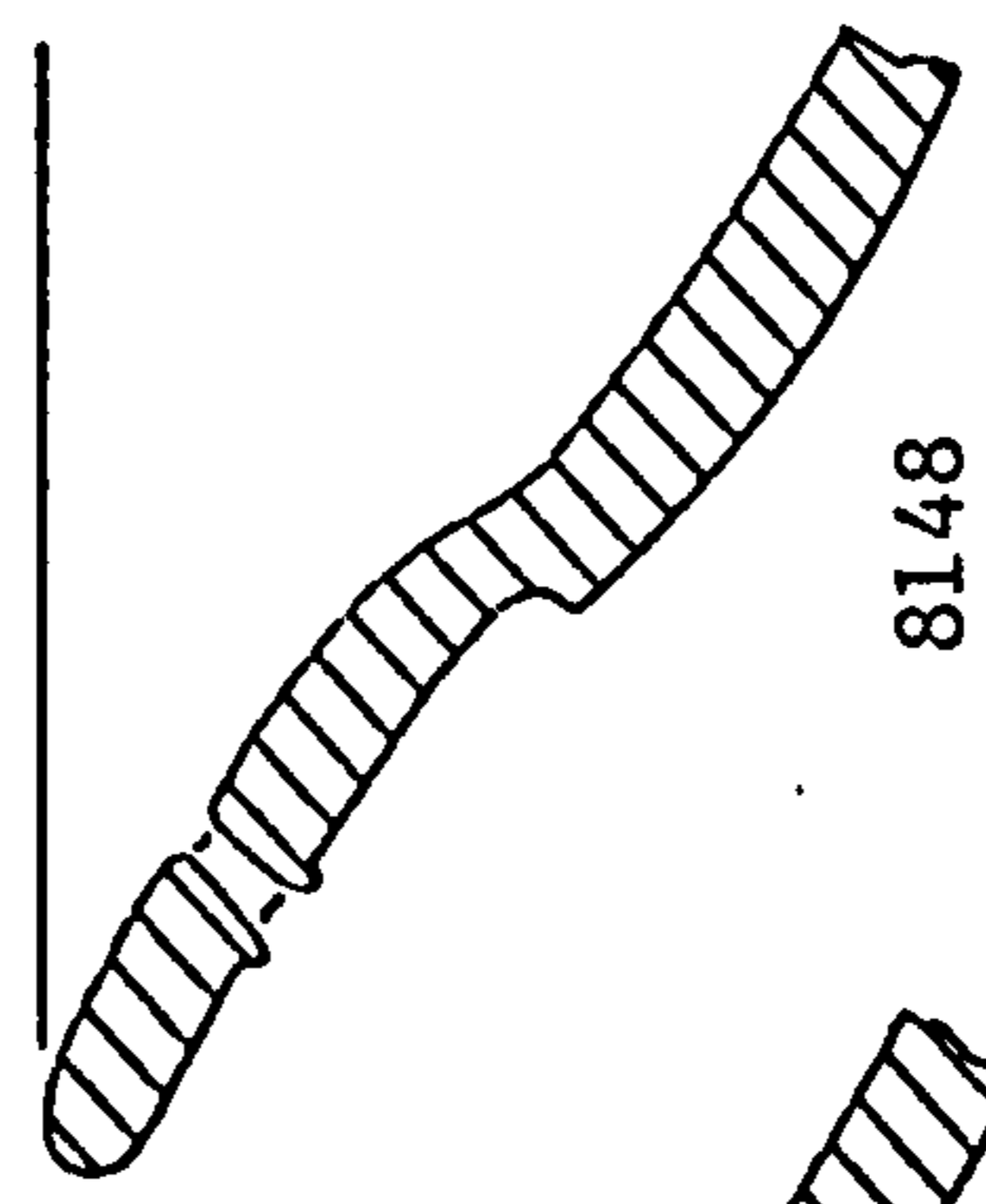

8150

Plate 15: SANTA OLAYA

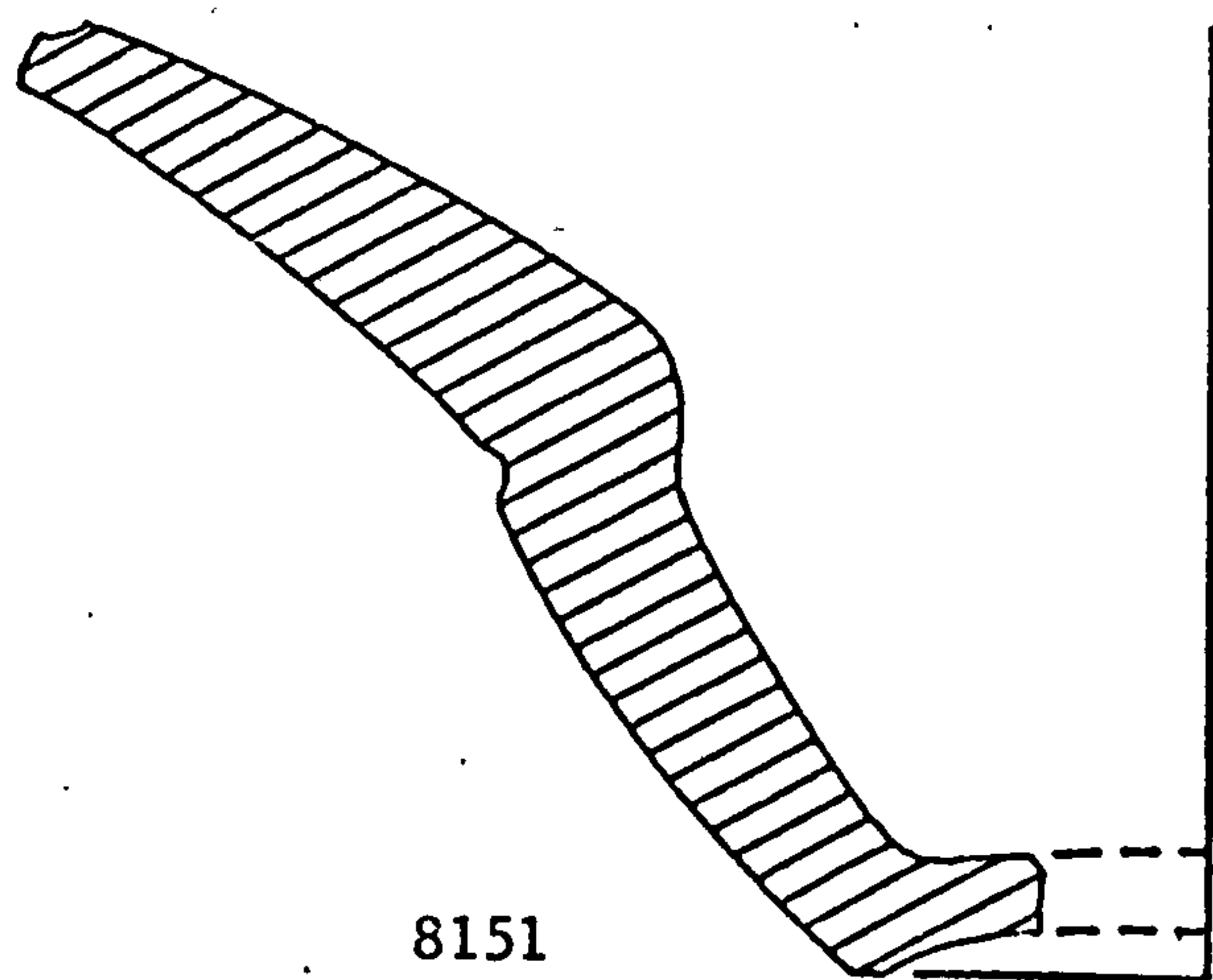
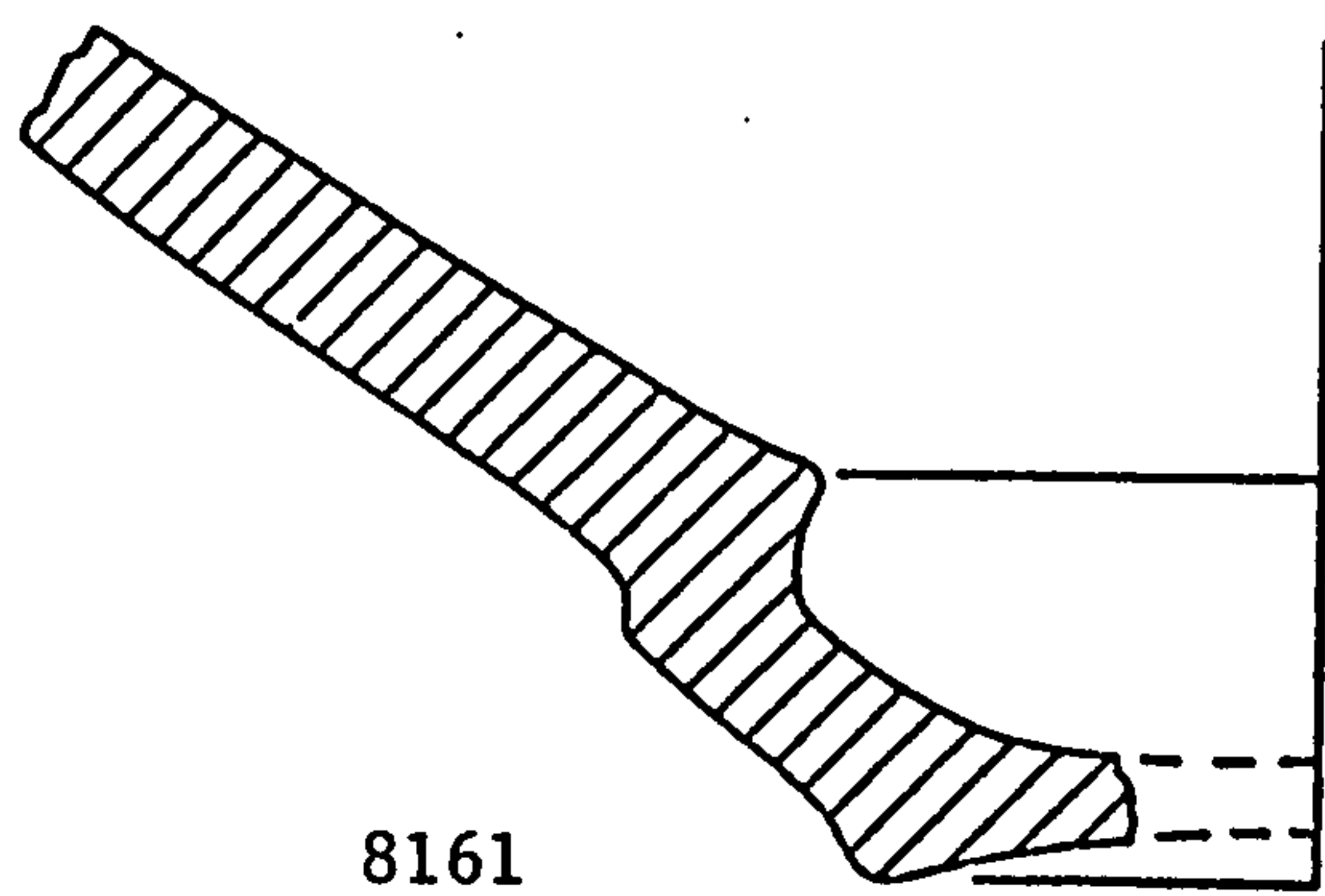
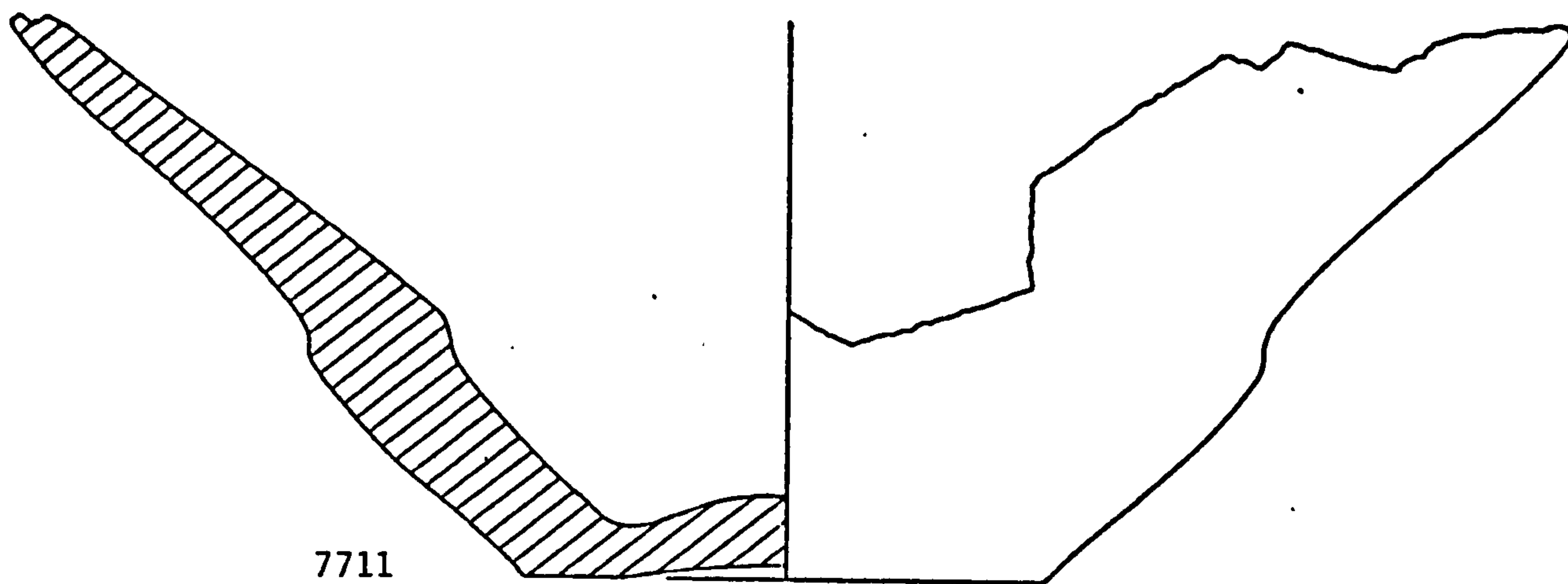

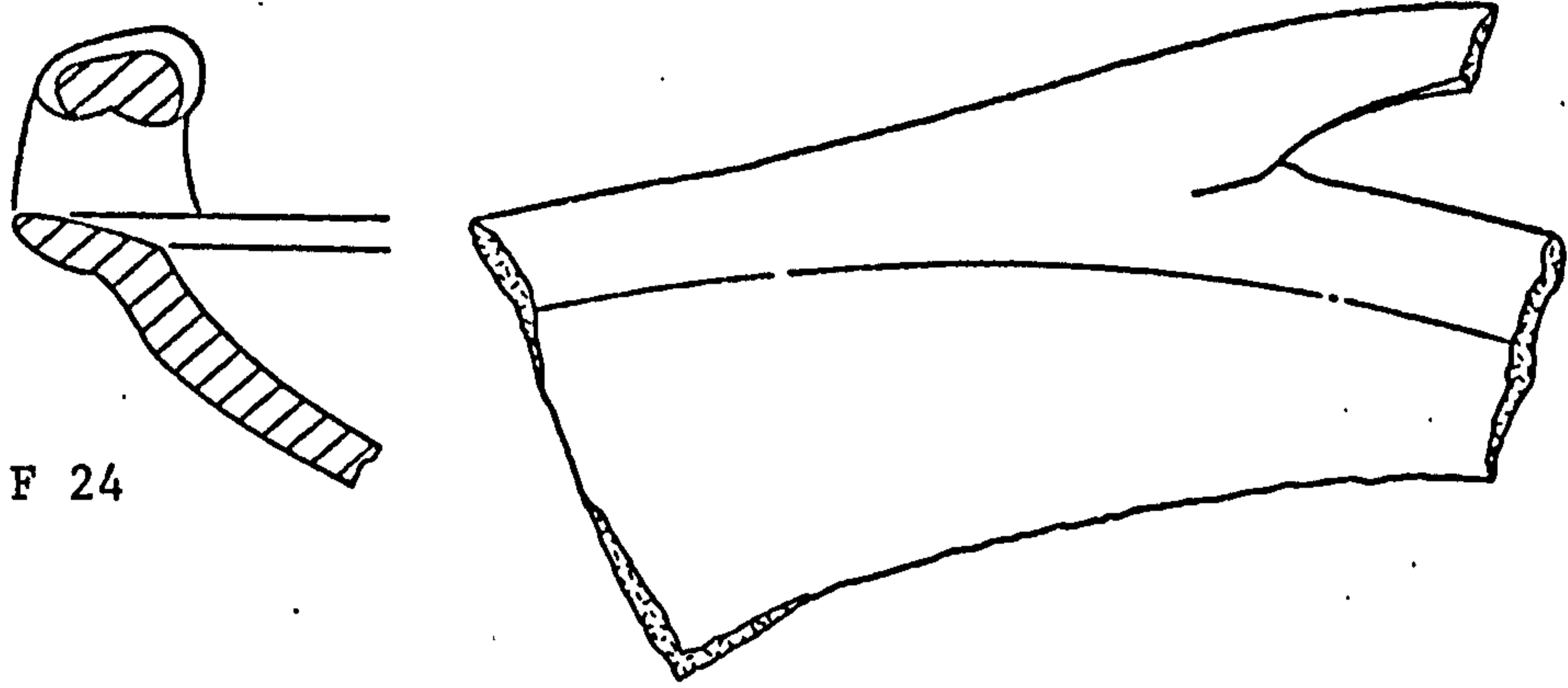

F 24

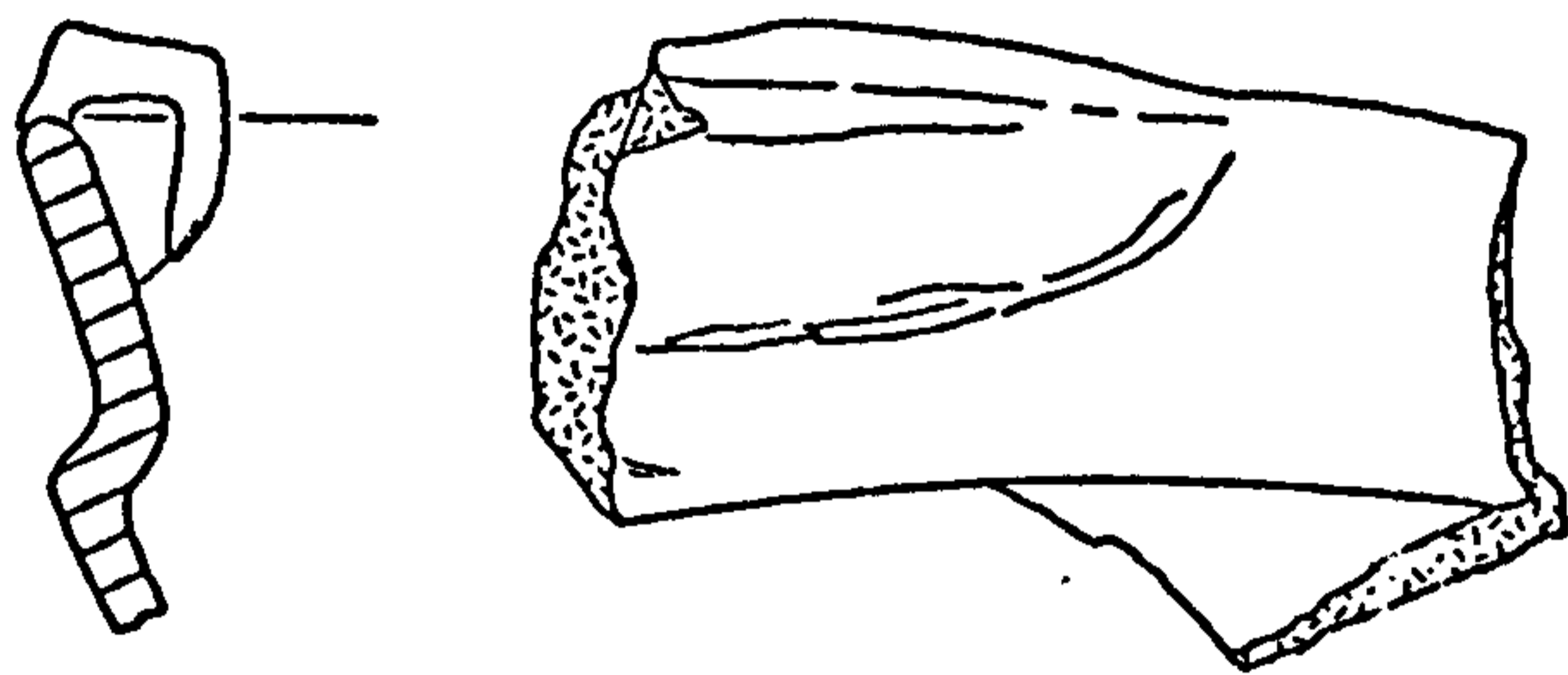

6707

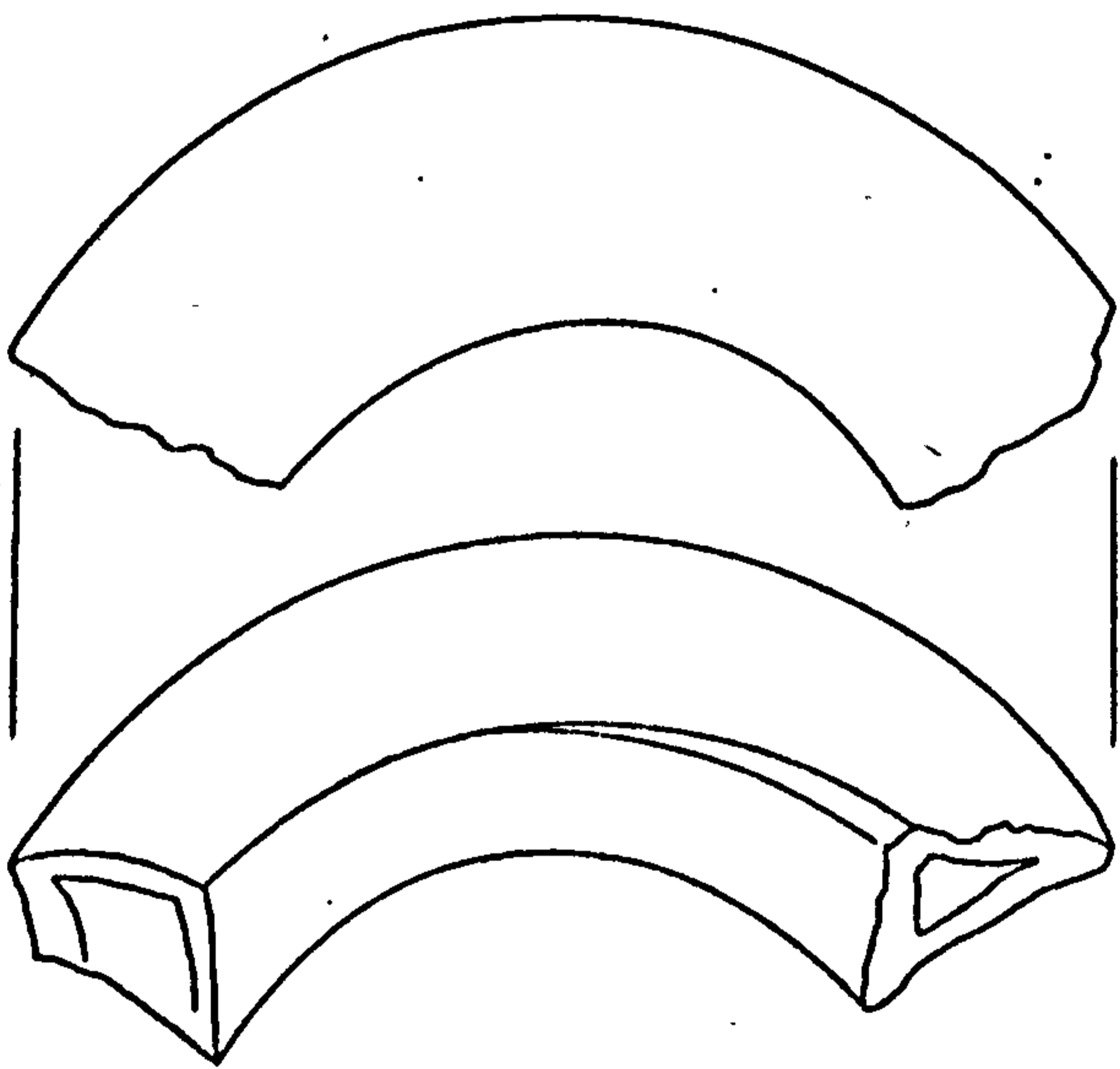

8266

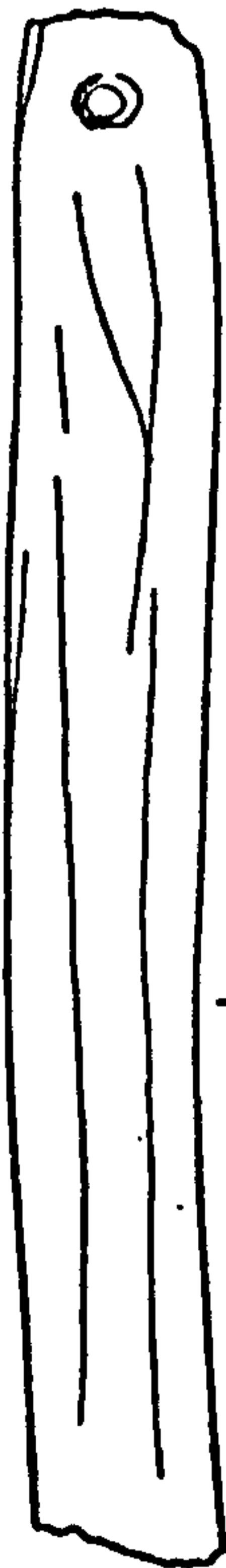
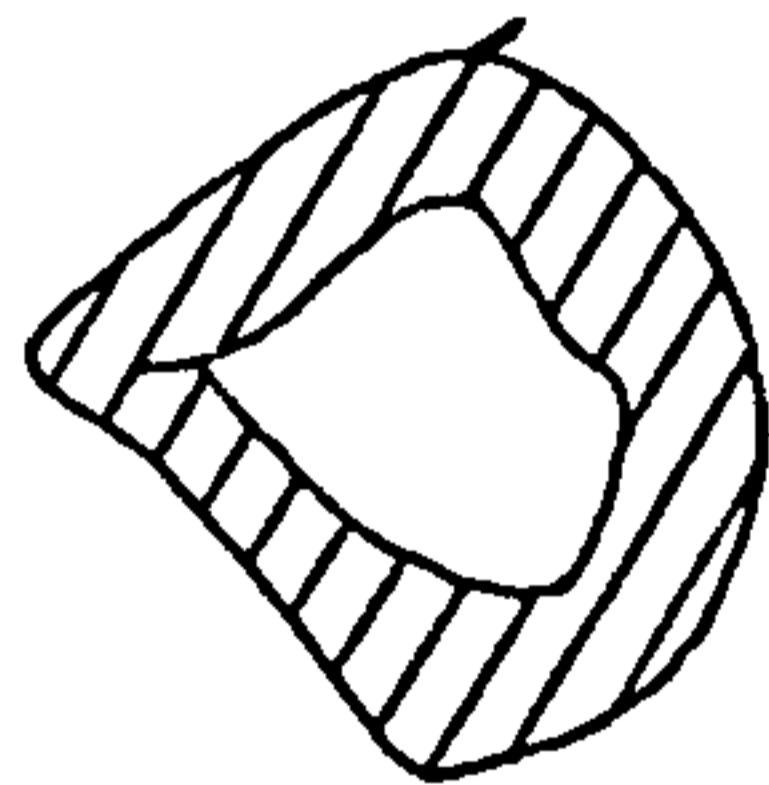

7915

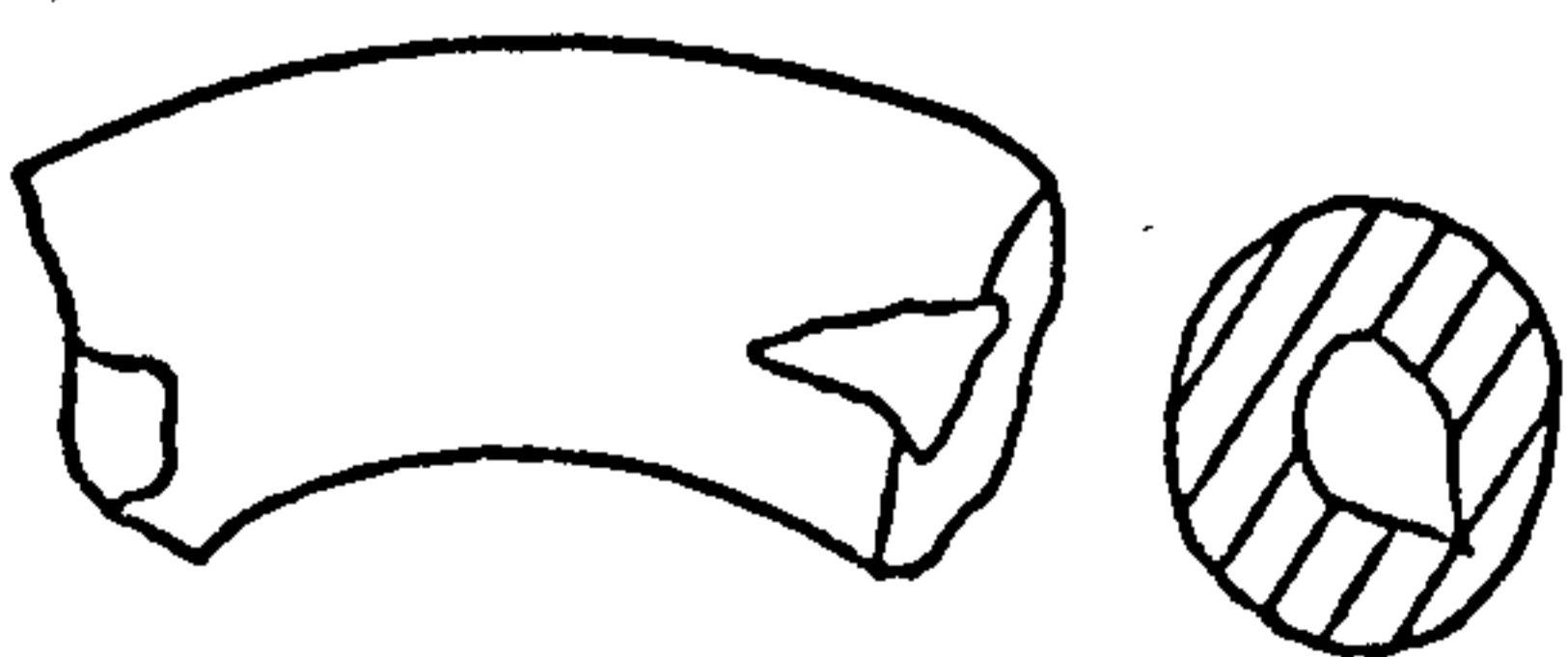
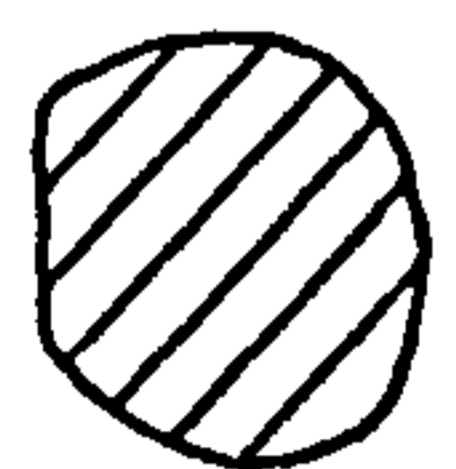

F 25

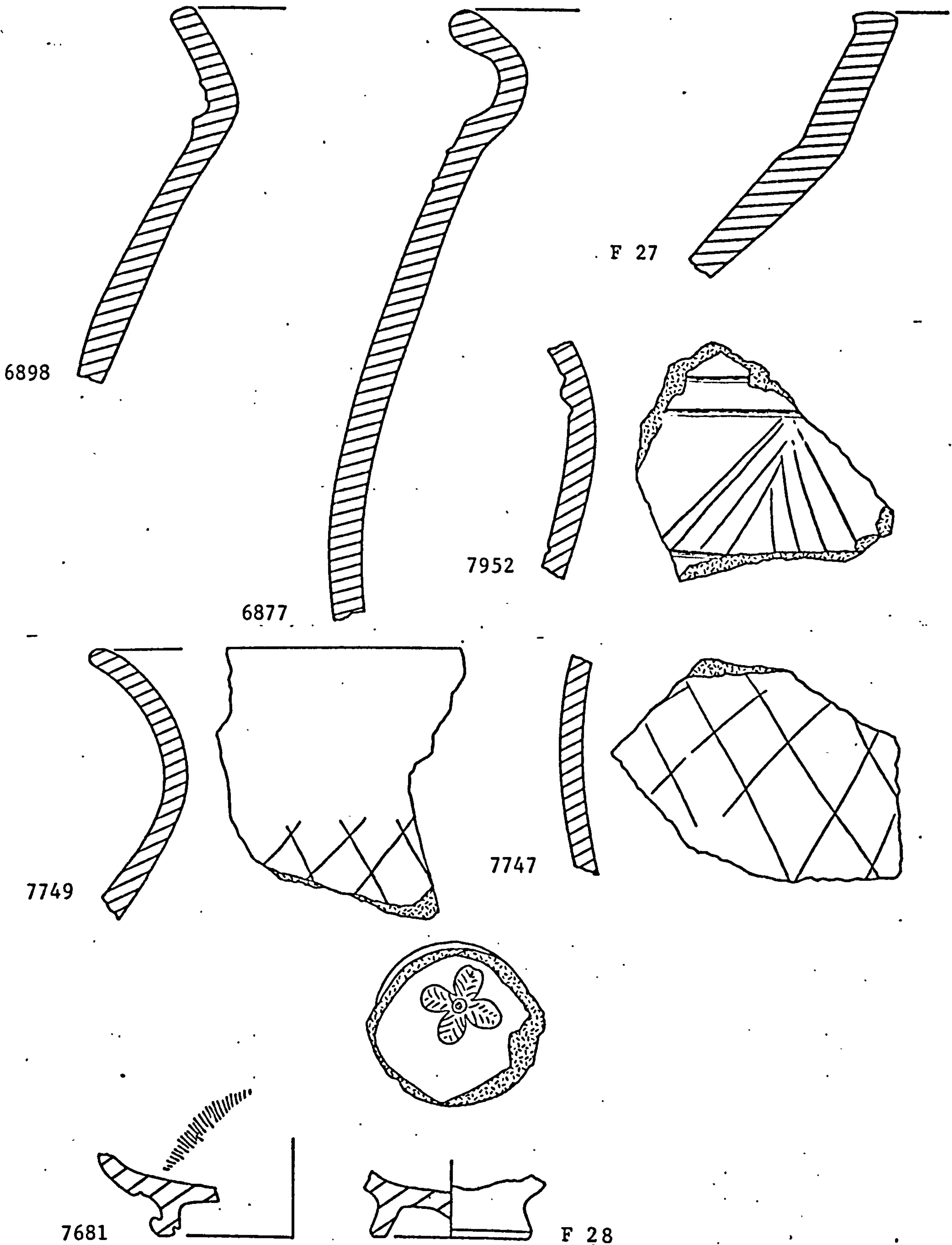
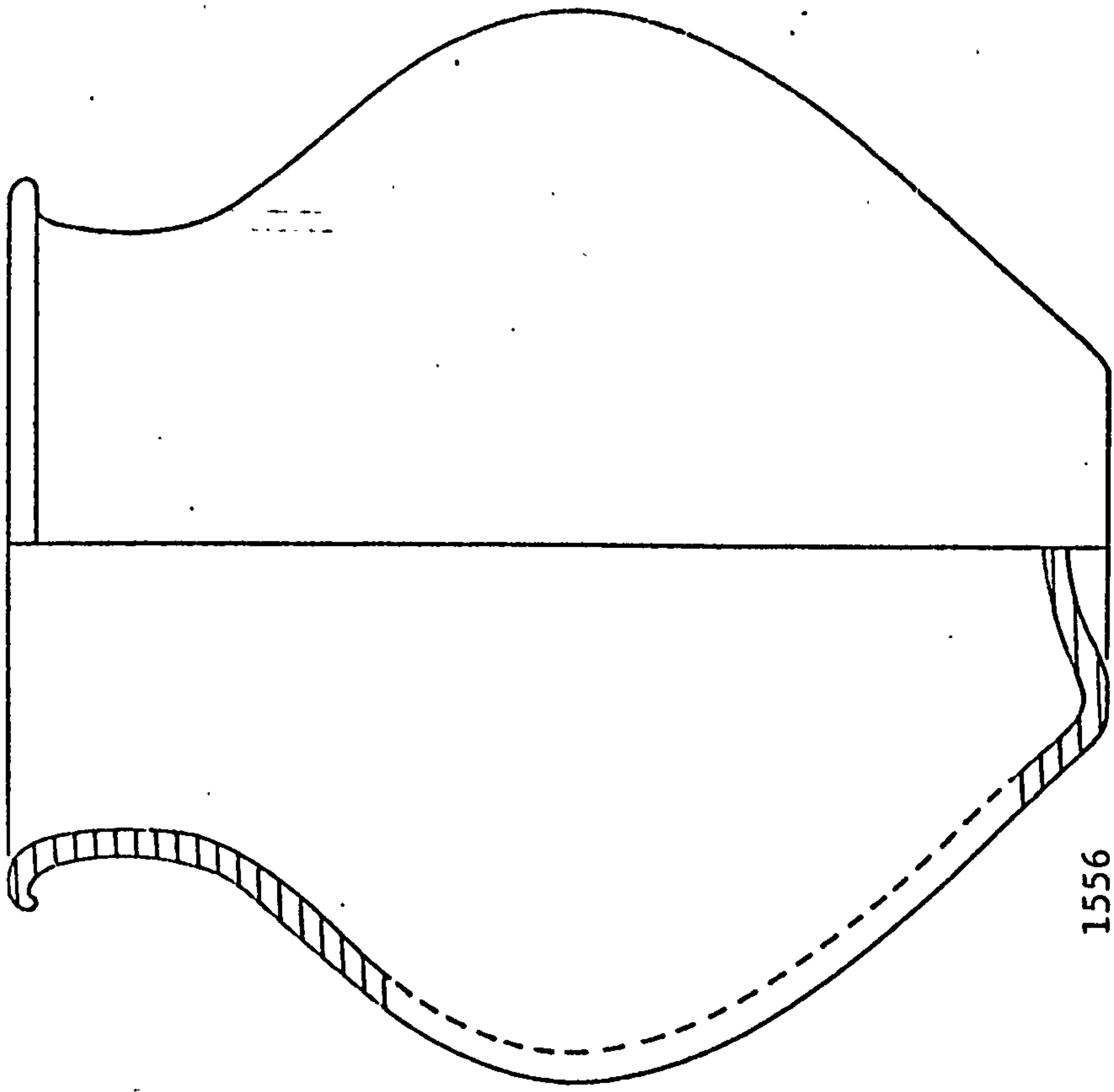
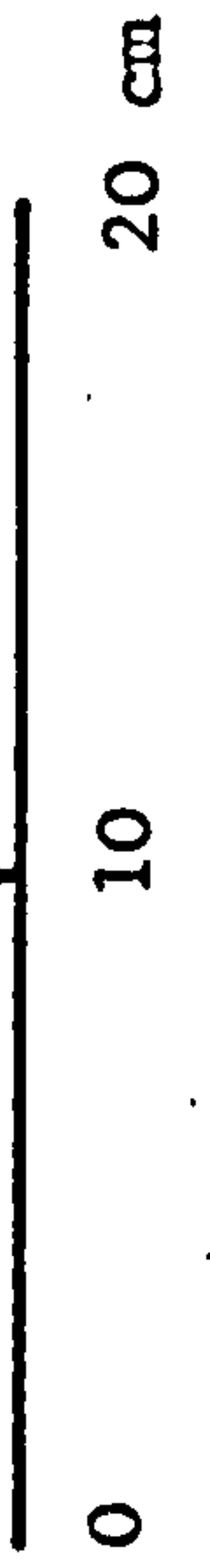
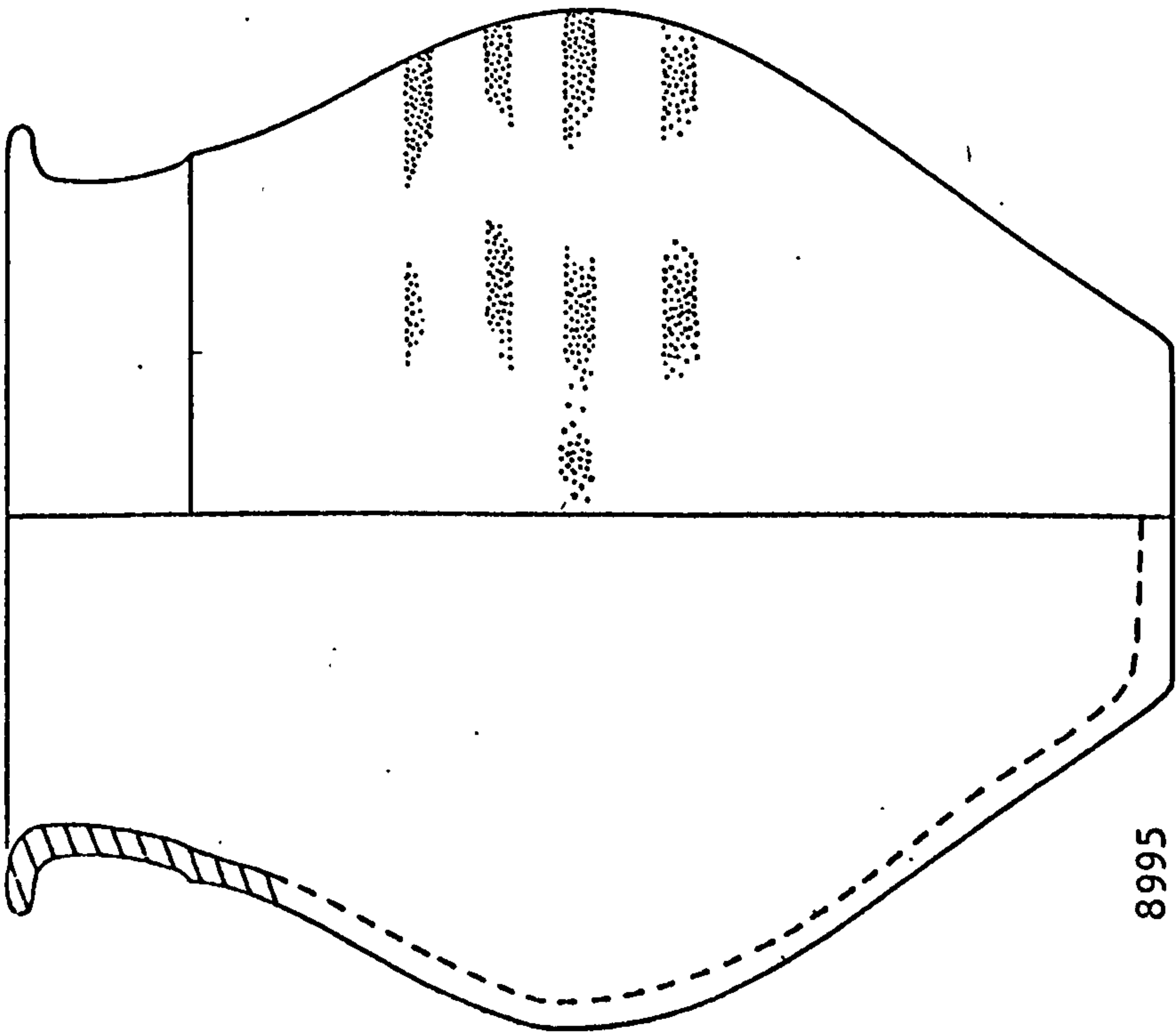

Plate 18: SANTA OLAYA

0 10 cm



1556



8995

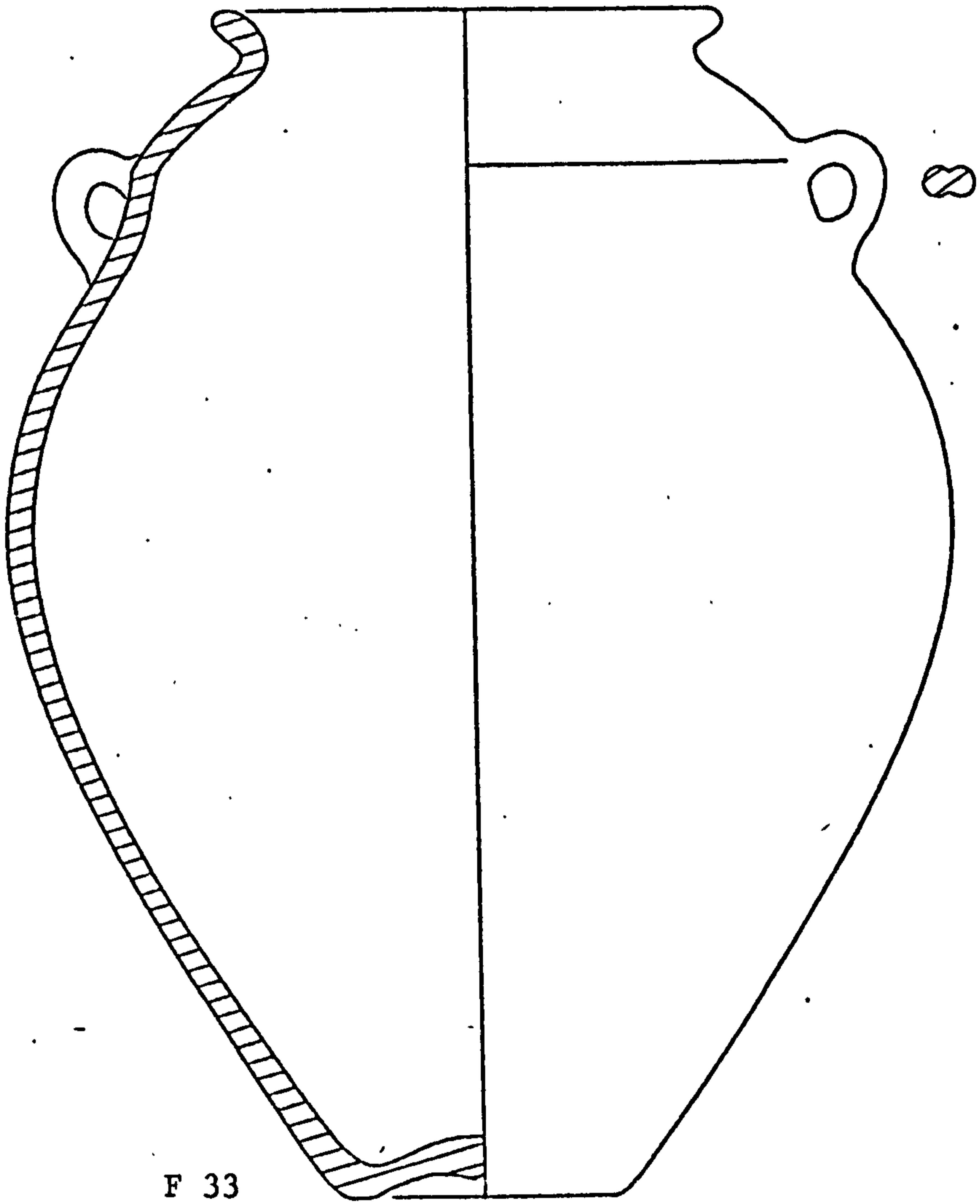

F 33

Plate 20: SANTA OLAYA

0 10 20 cm

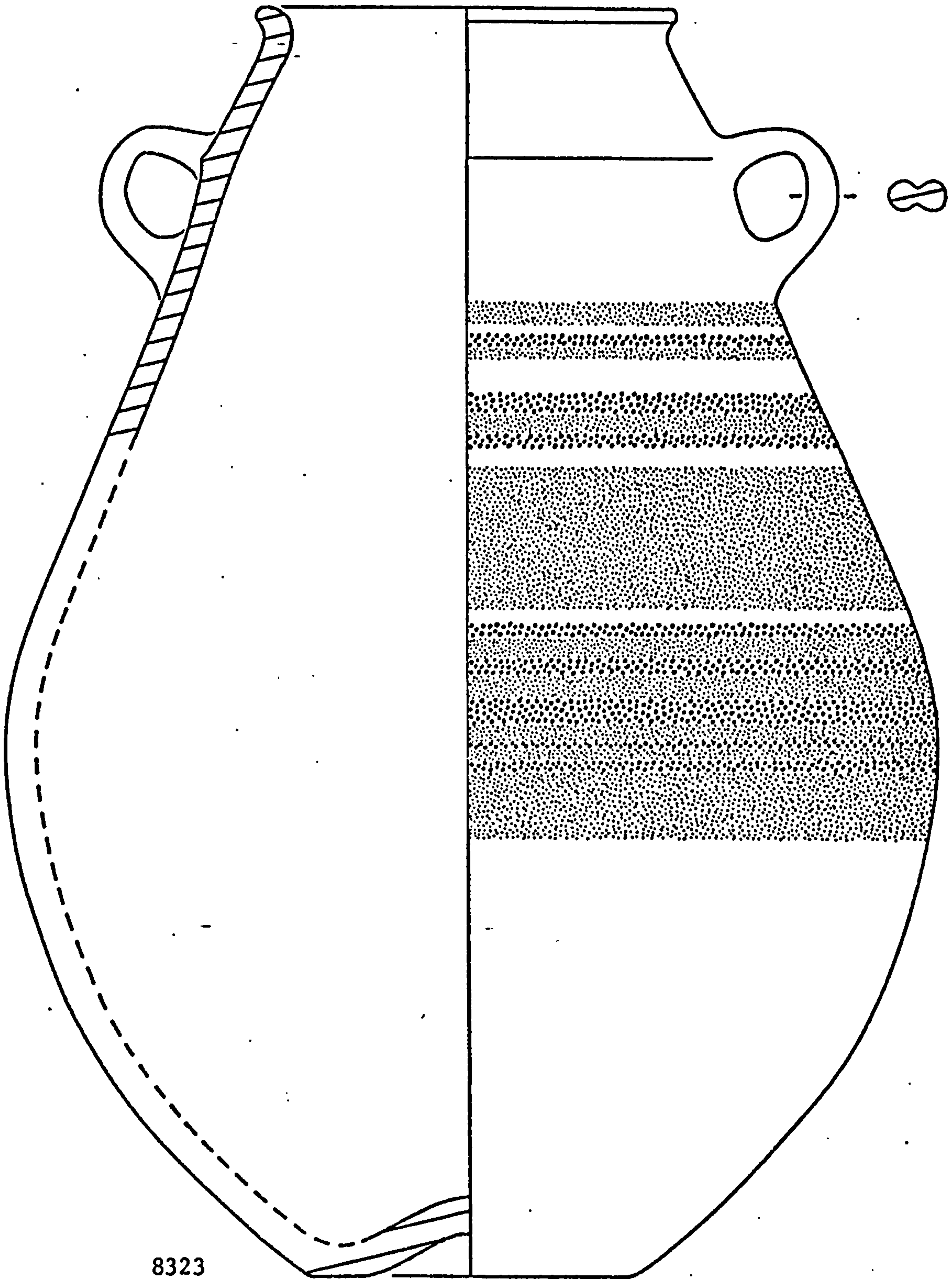

Plate 21: SANTA OLAYA

0 10 20 cm

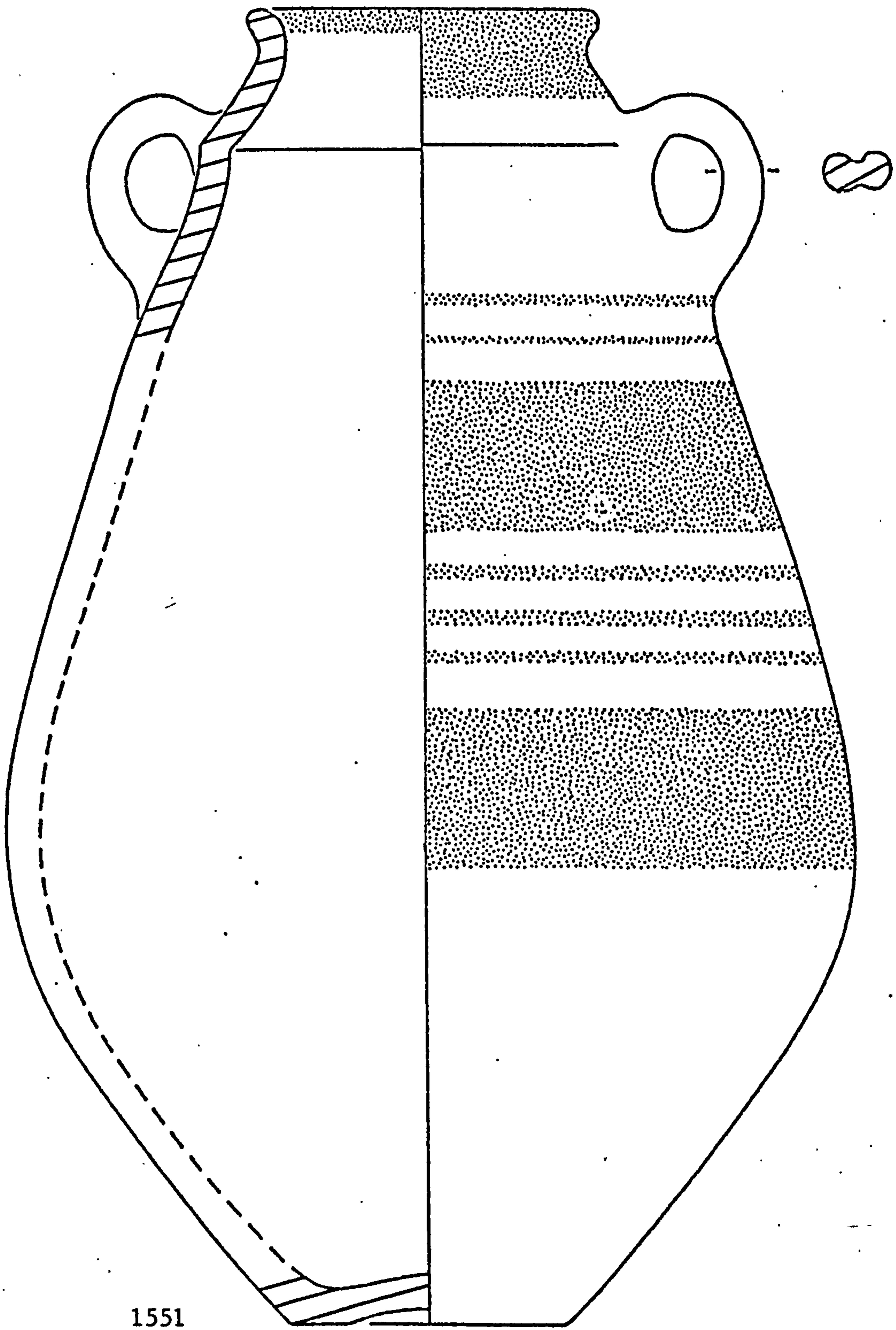
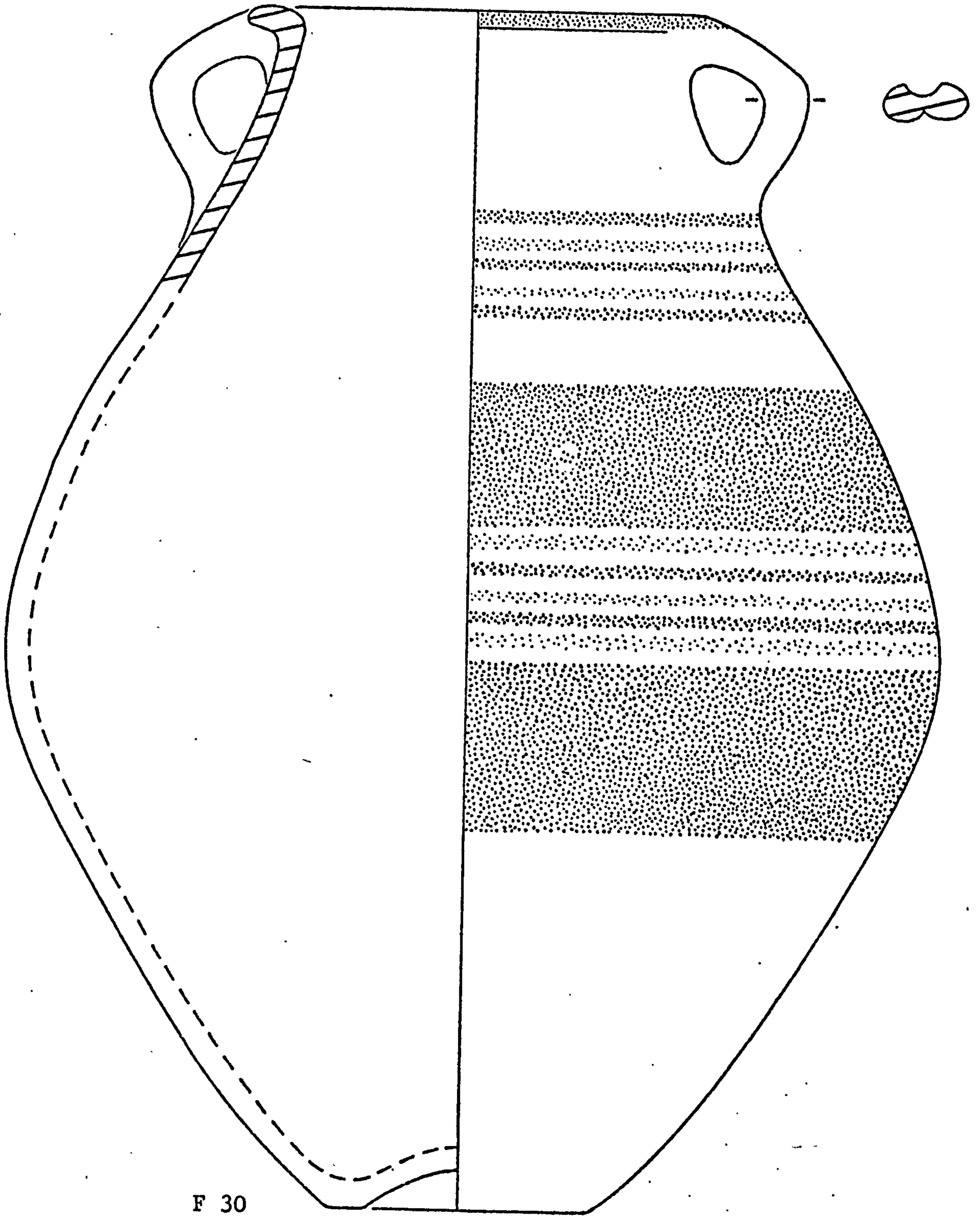

Plate 22: SANTA OLAYA

0 10 20 cm



F 30

Plate 23: SANTA OLAYA

0 10 20 cm

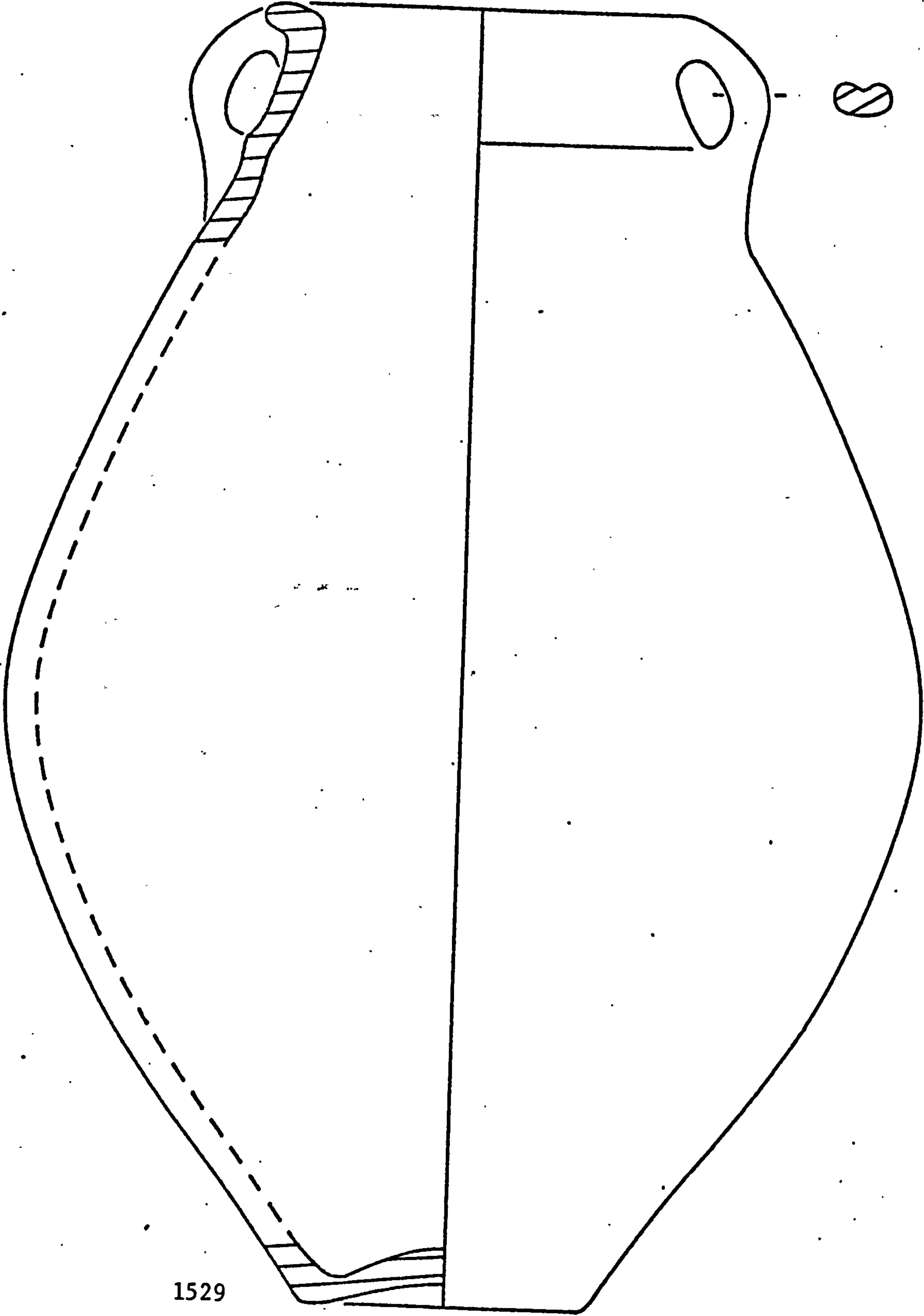

1529

Plate 24: SANTA OLAYA

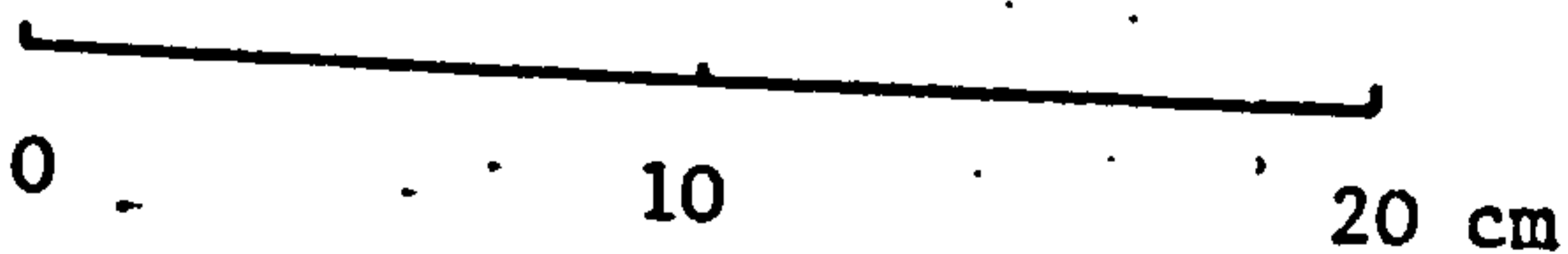

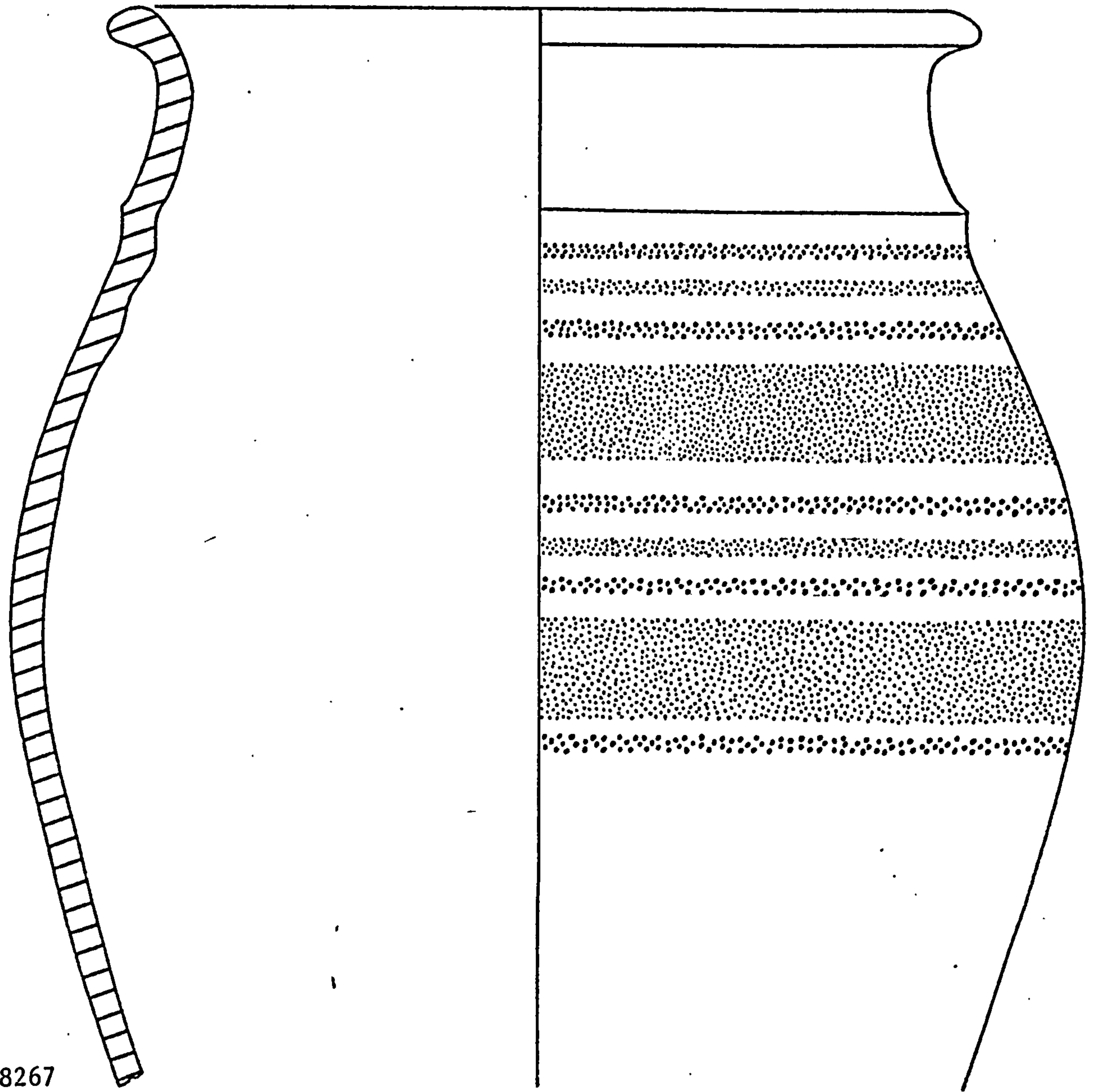

8267

Plate 25: SANTA OLAYA

0

10 cm

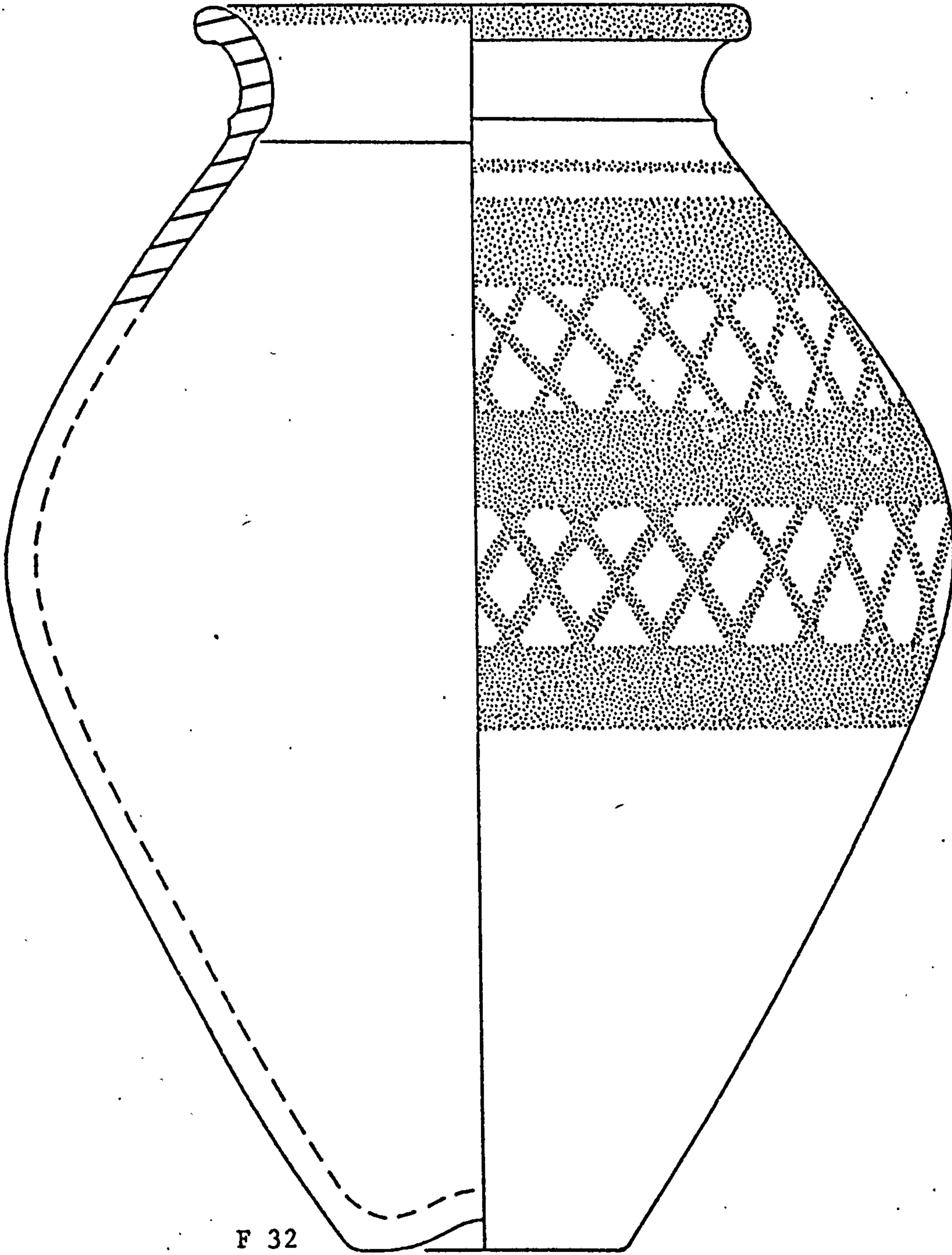
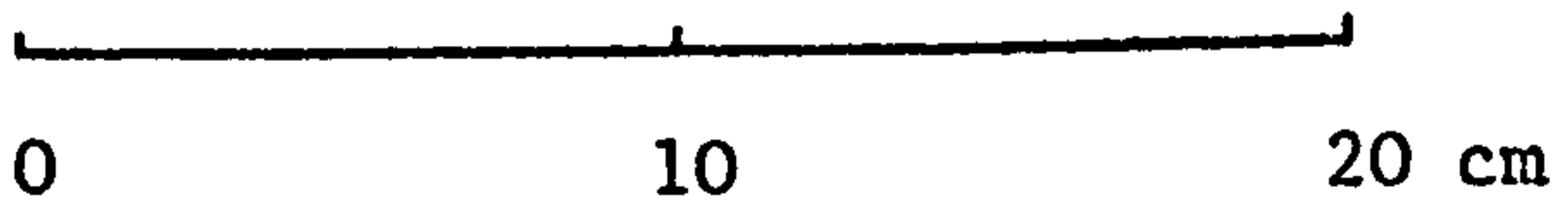
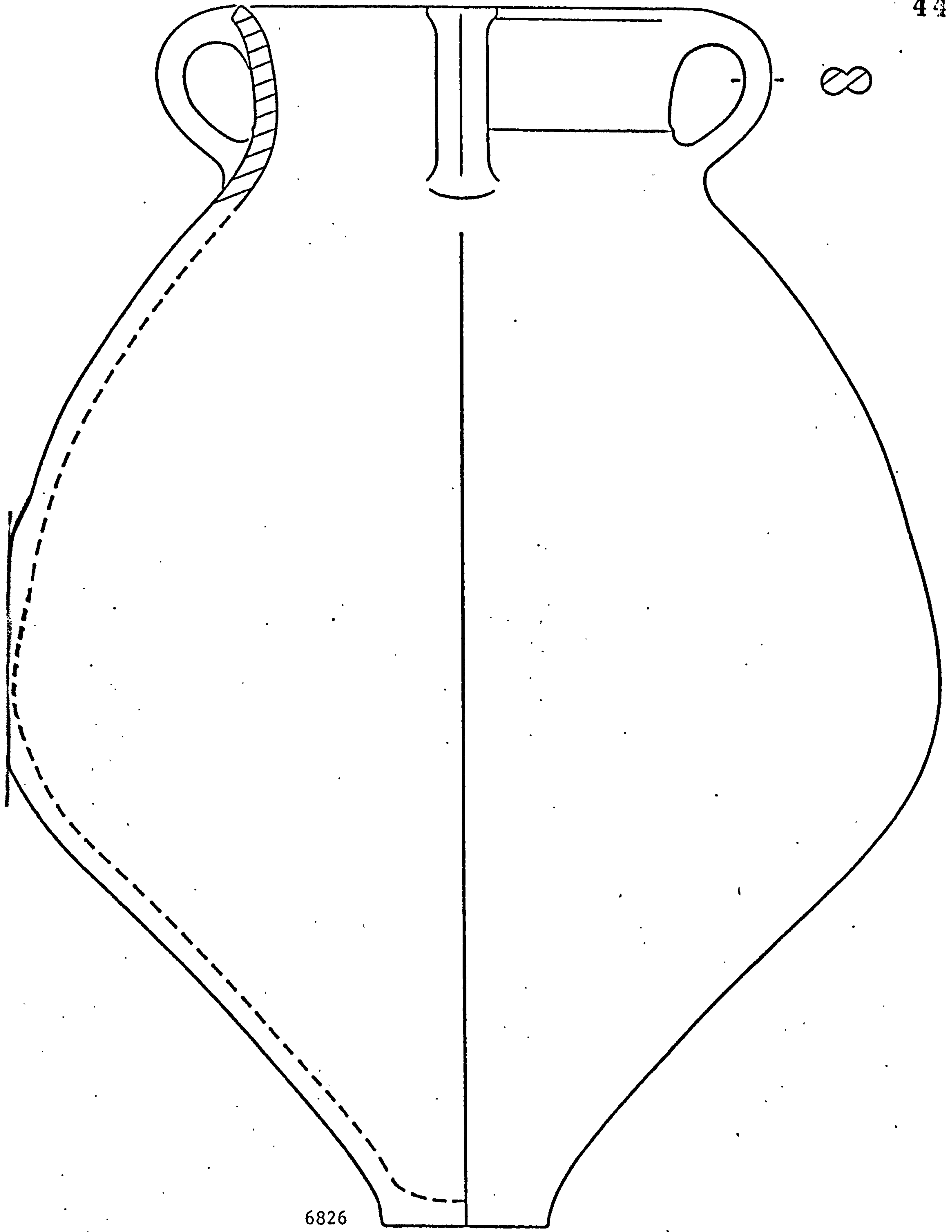

Plate 26: SANTA OLAYA





6826

Plate 27: SANTA OLAYA

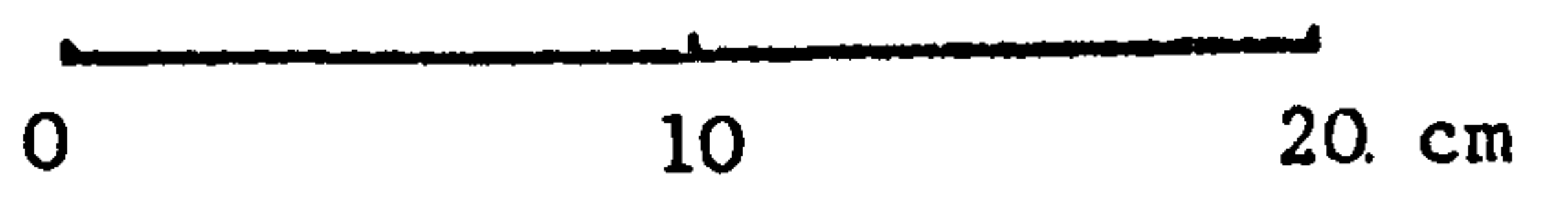

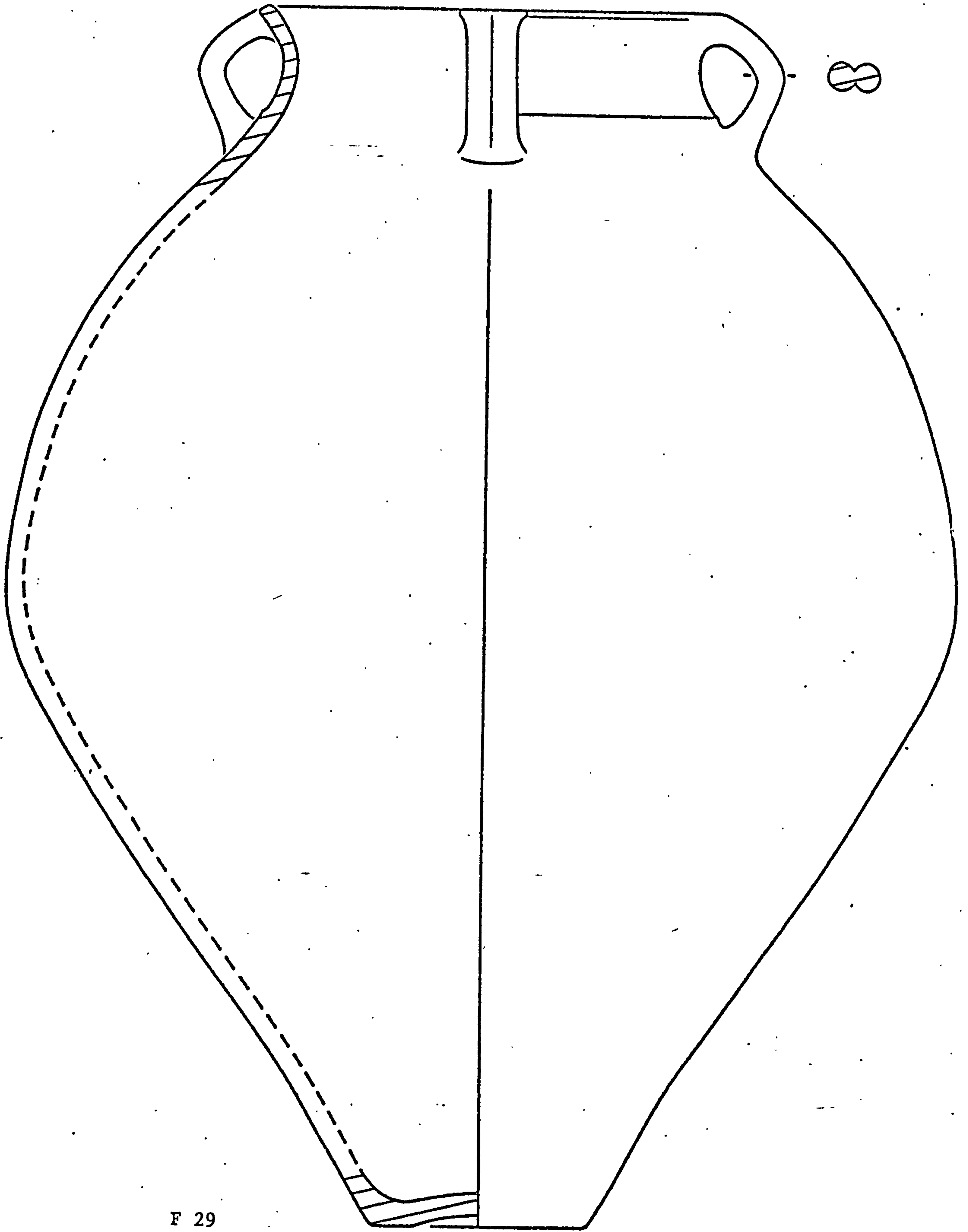

F 29

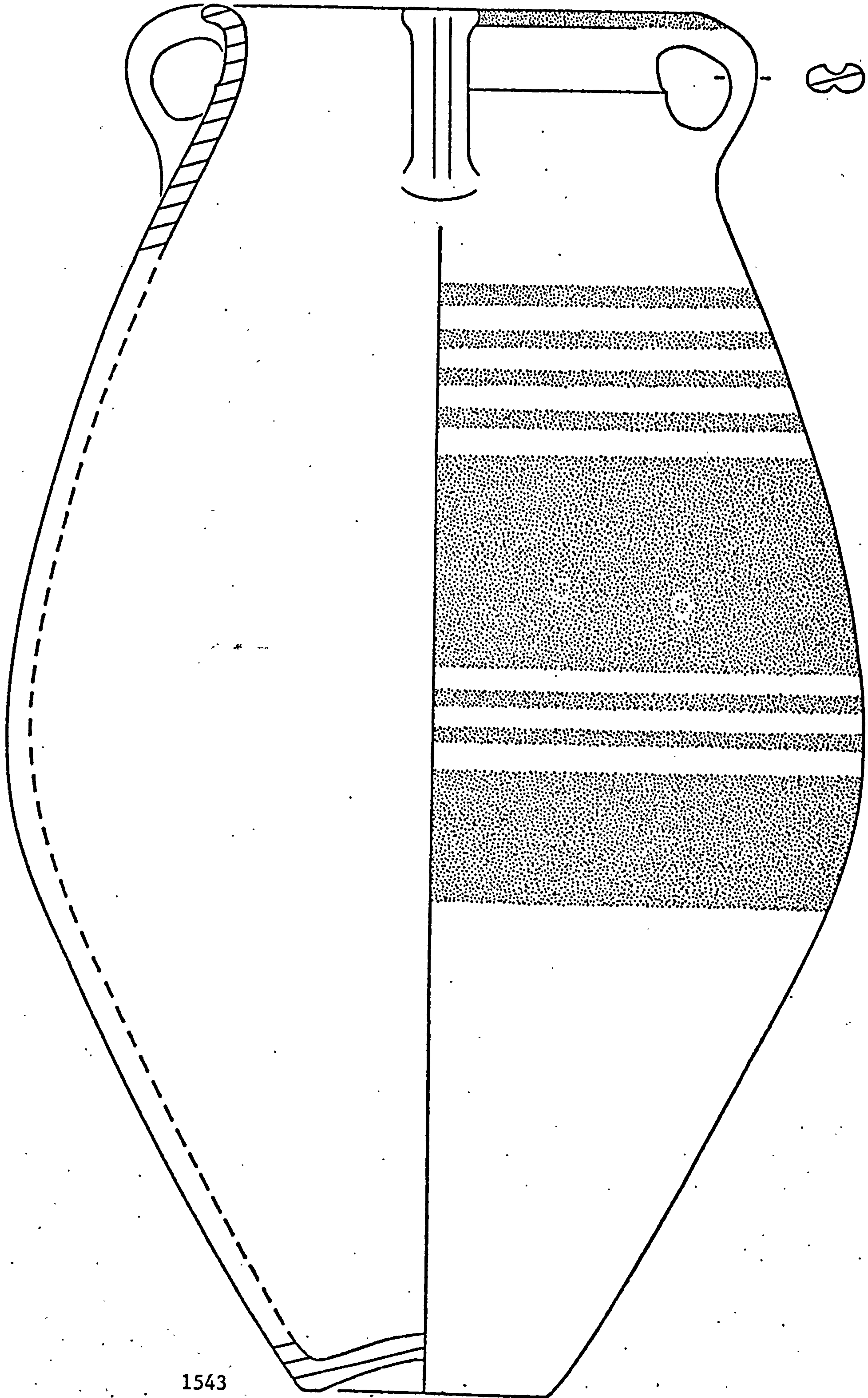

1543

Plate 29: SANTA OLAYA

0 10 20 cm

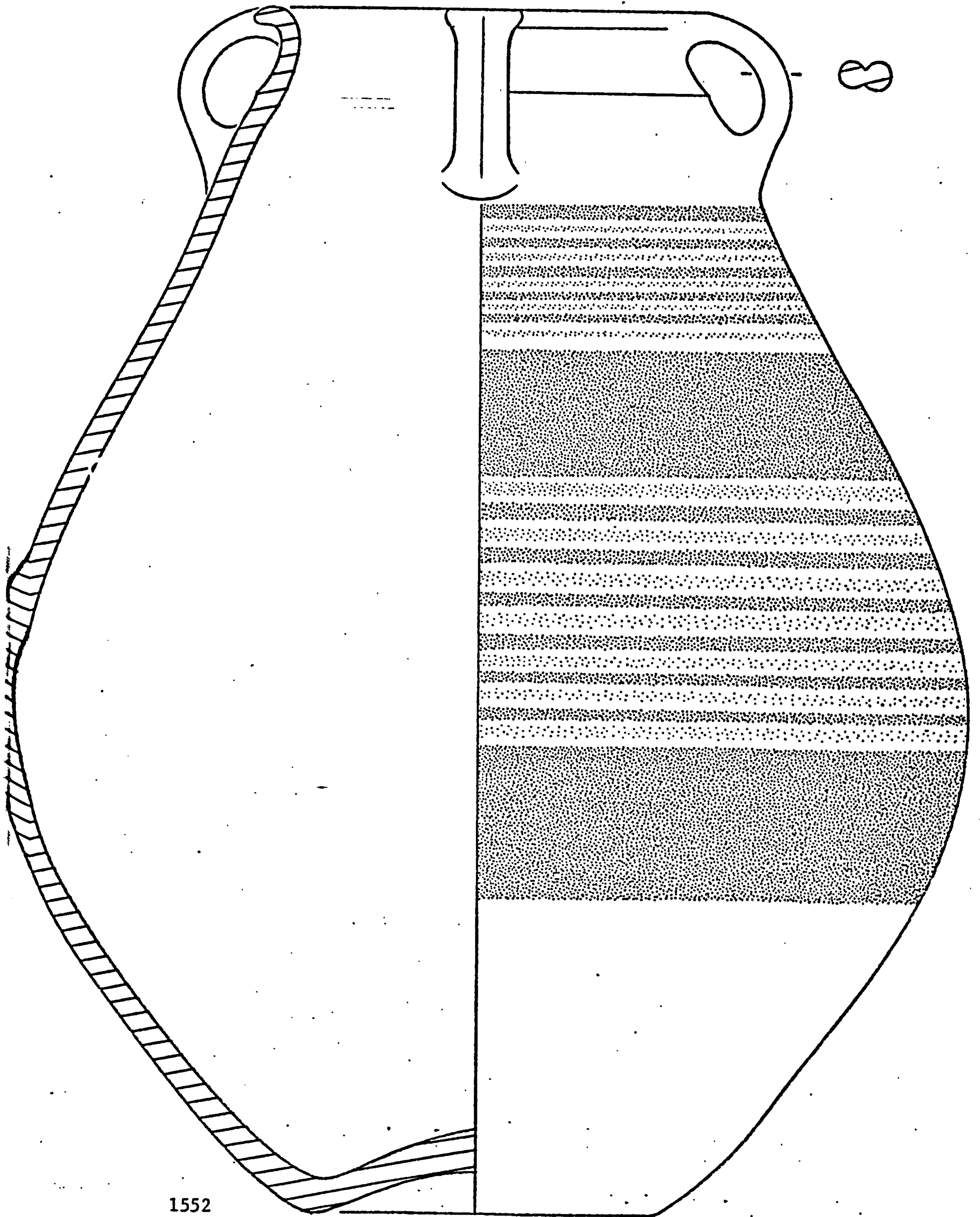

1552

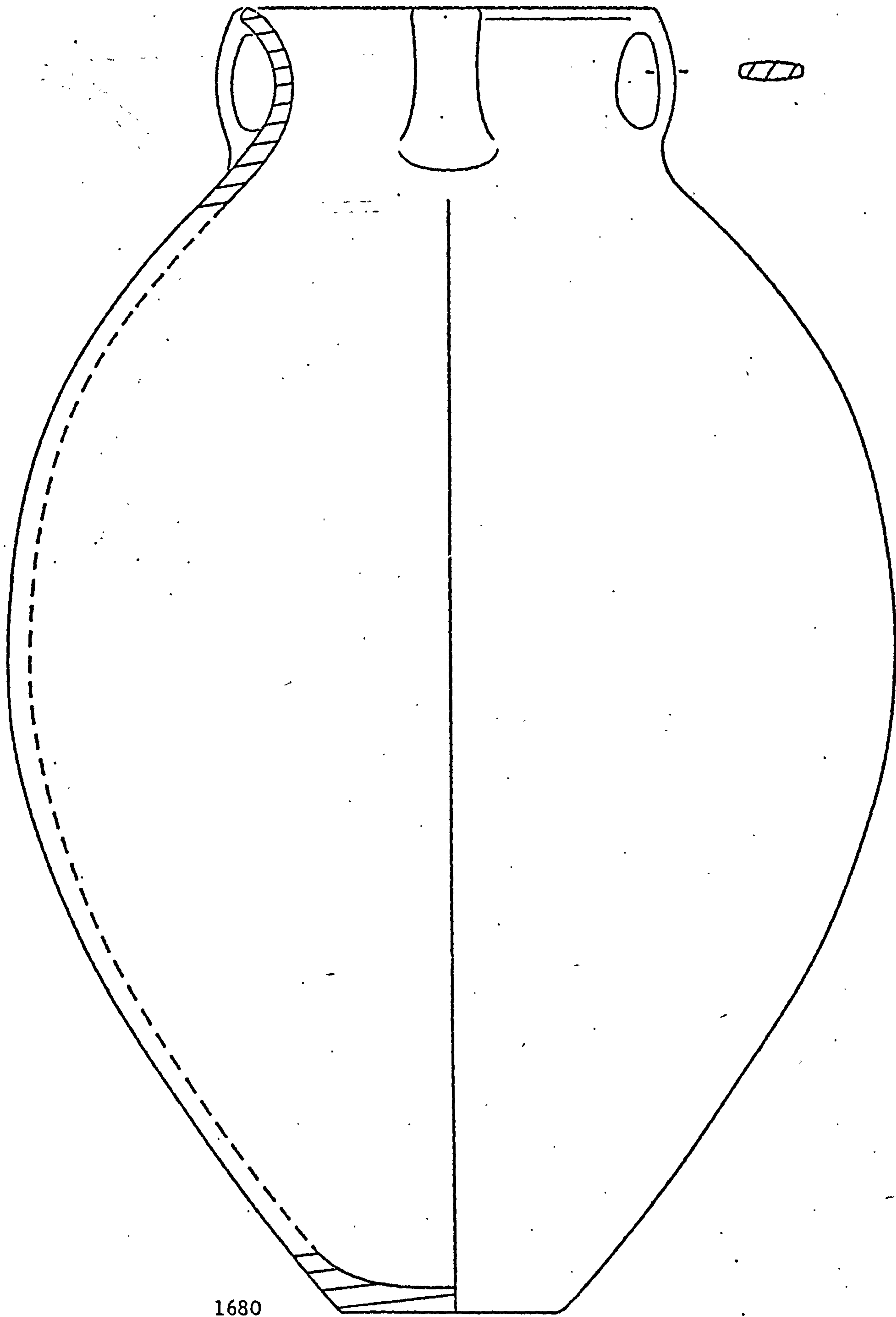

1680

Plate 31: SANTA OLAYA

0 10 20 cm

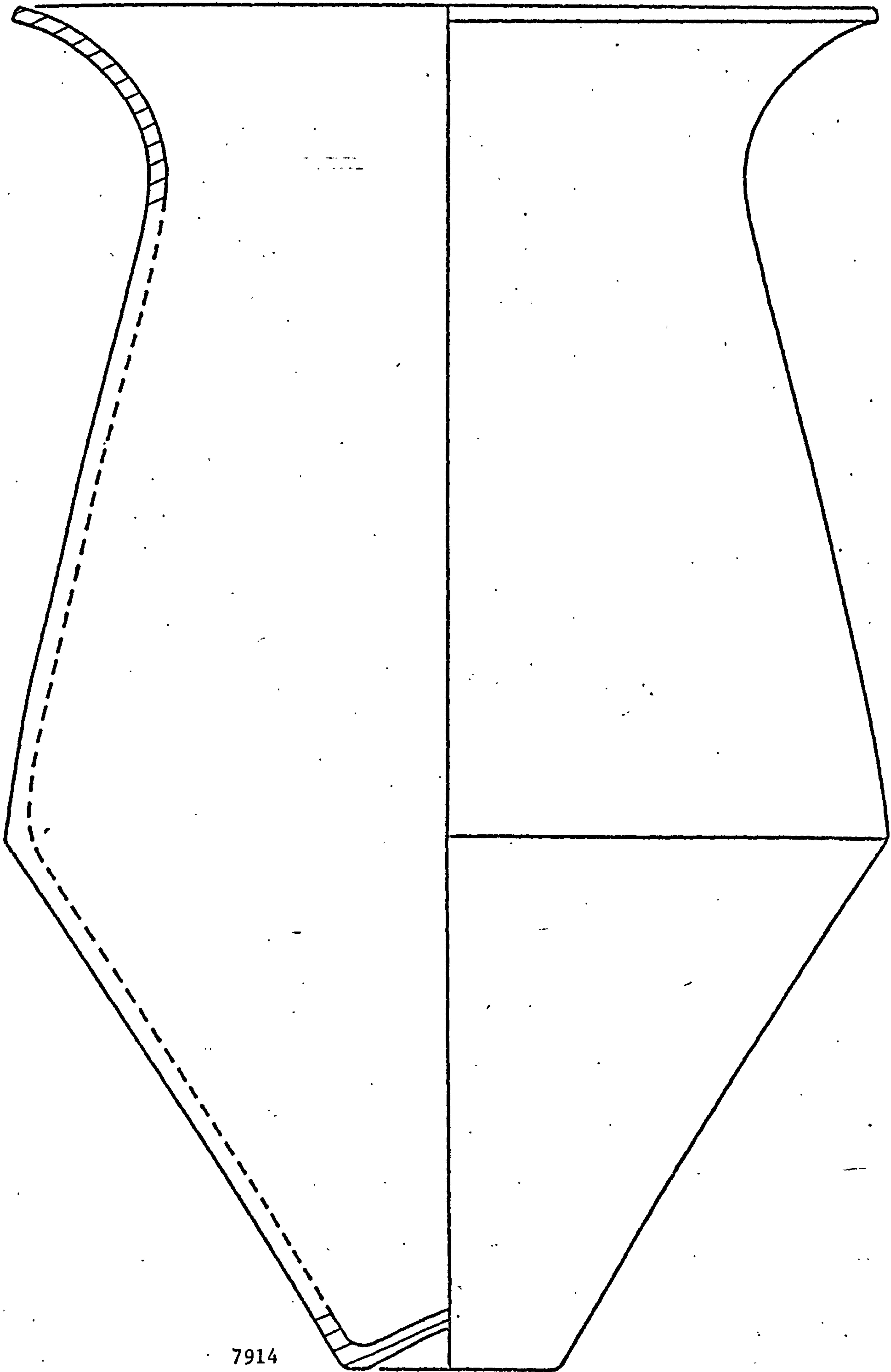

7914

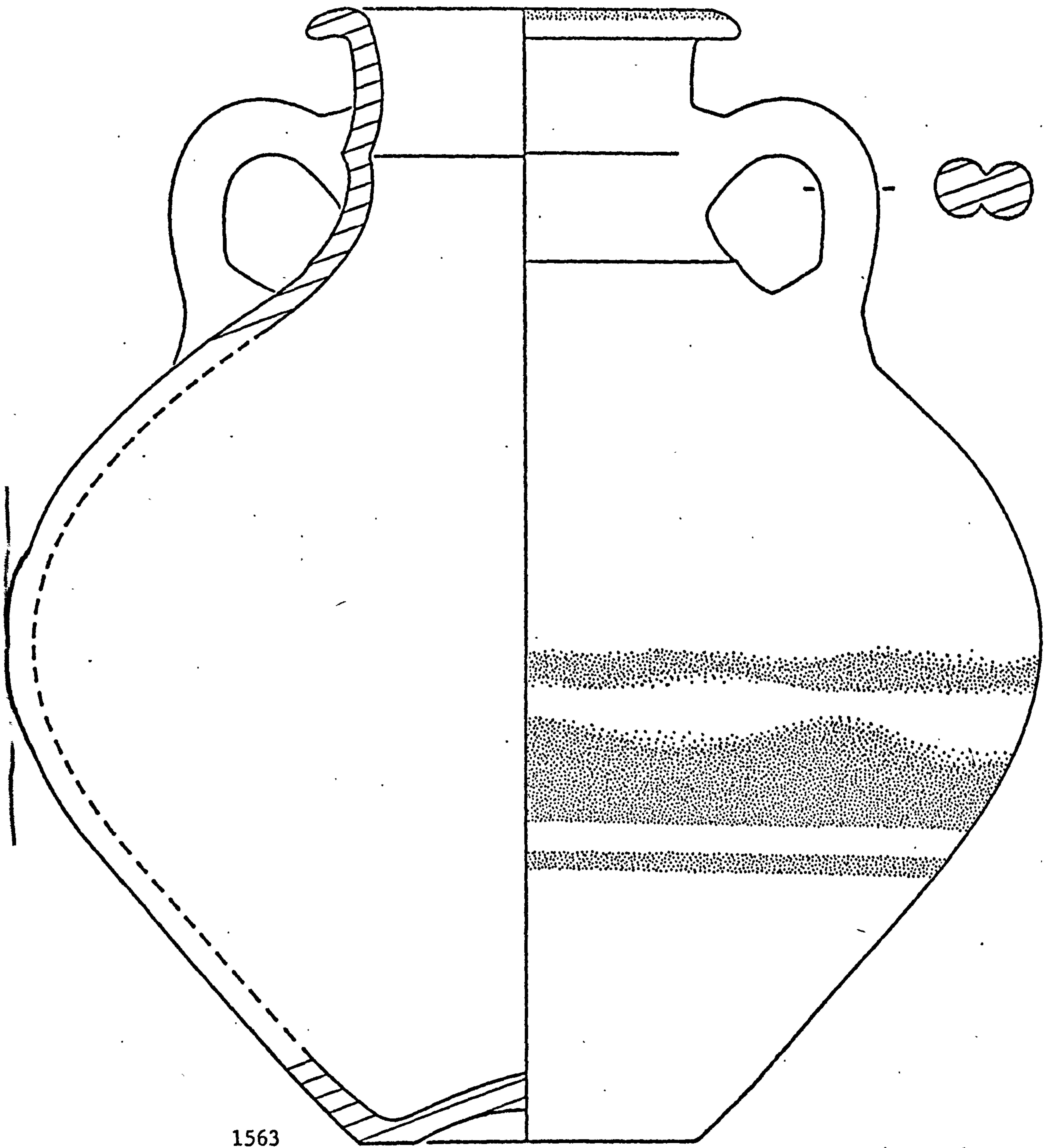

1563

Plate 33: SANTA OLAYA

0 10 cm

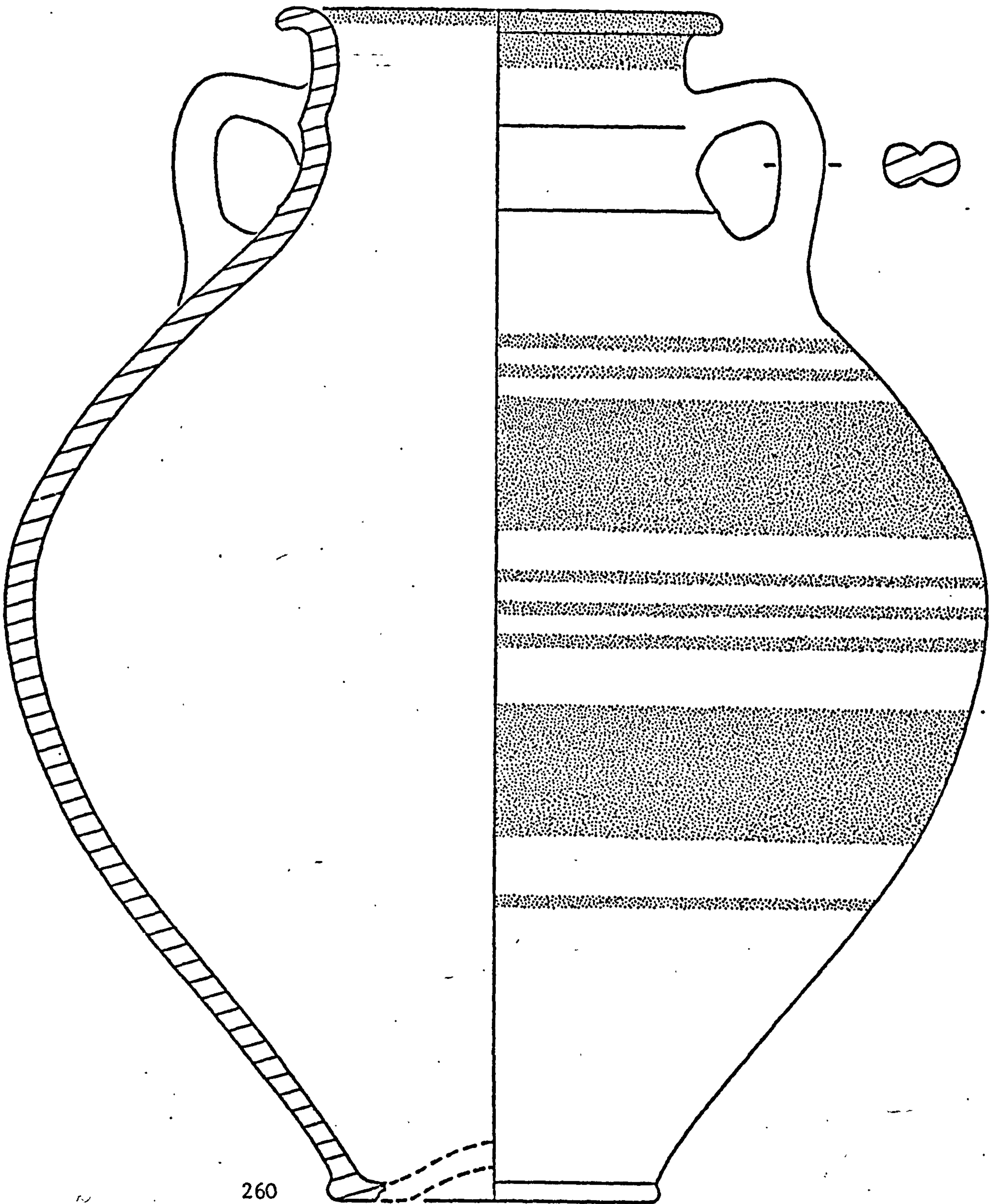

260

Plate 34: SANTA OLAYA

0 10 cm

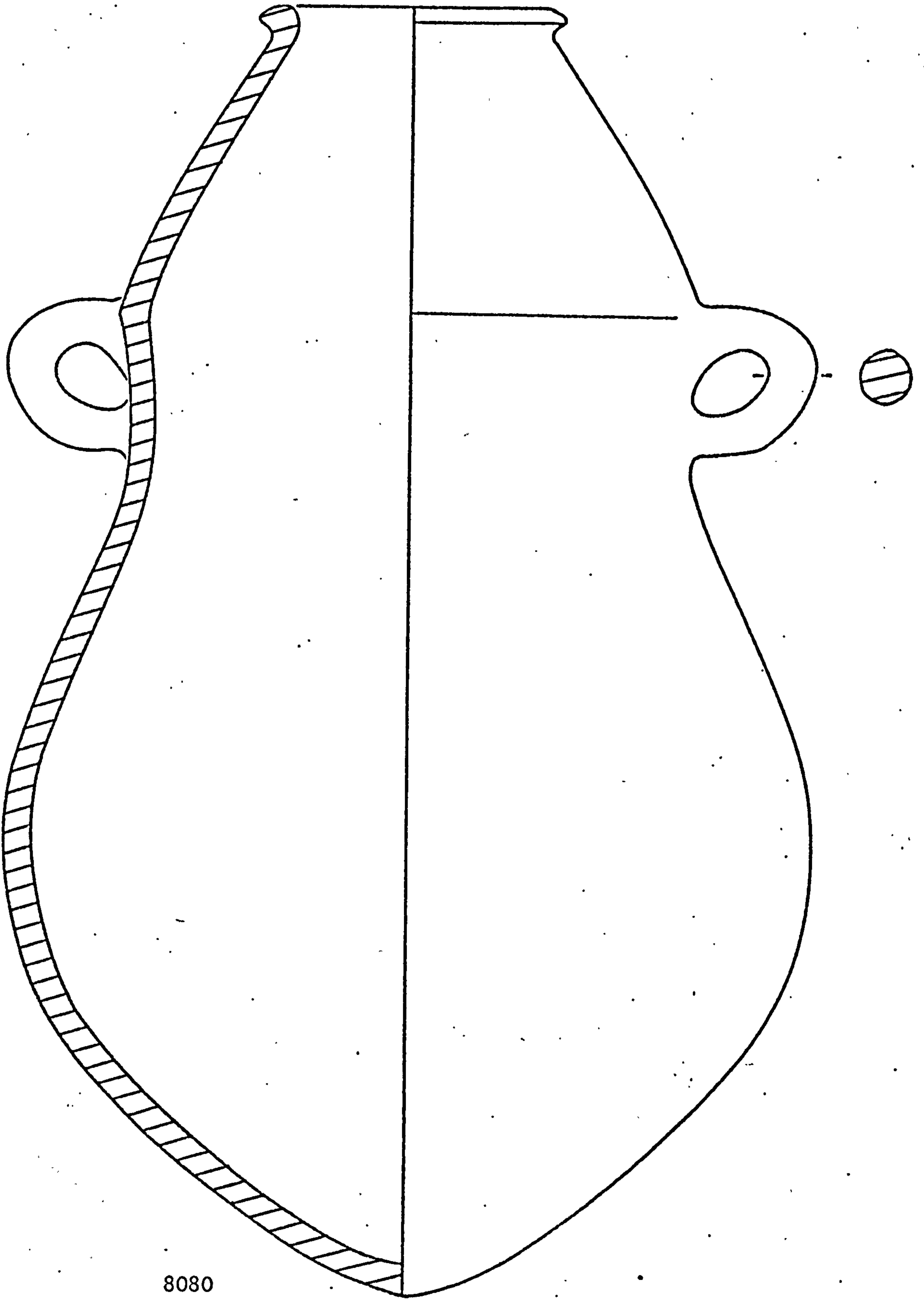

8080

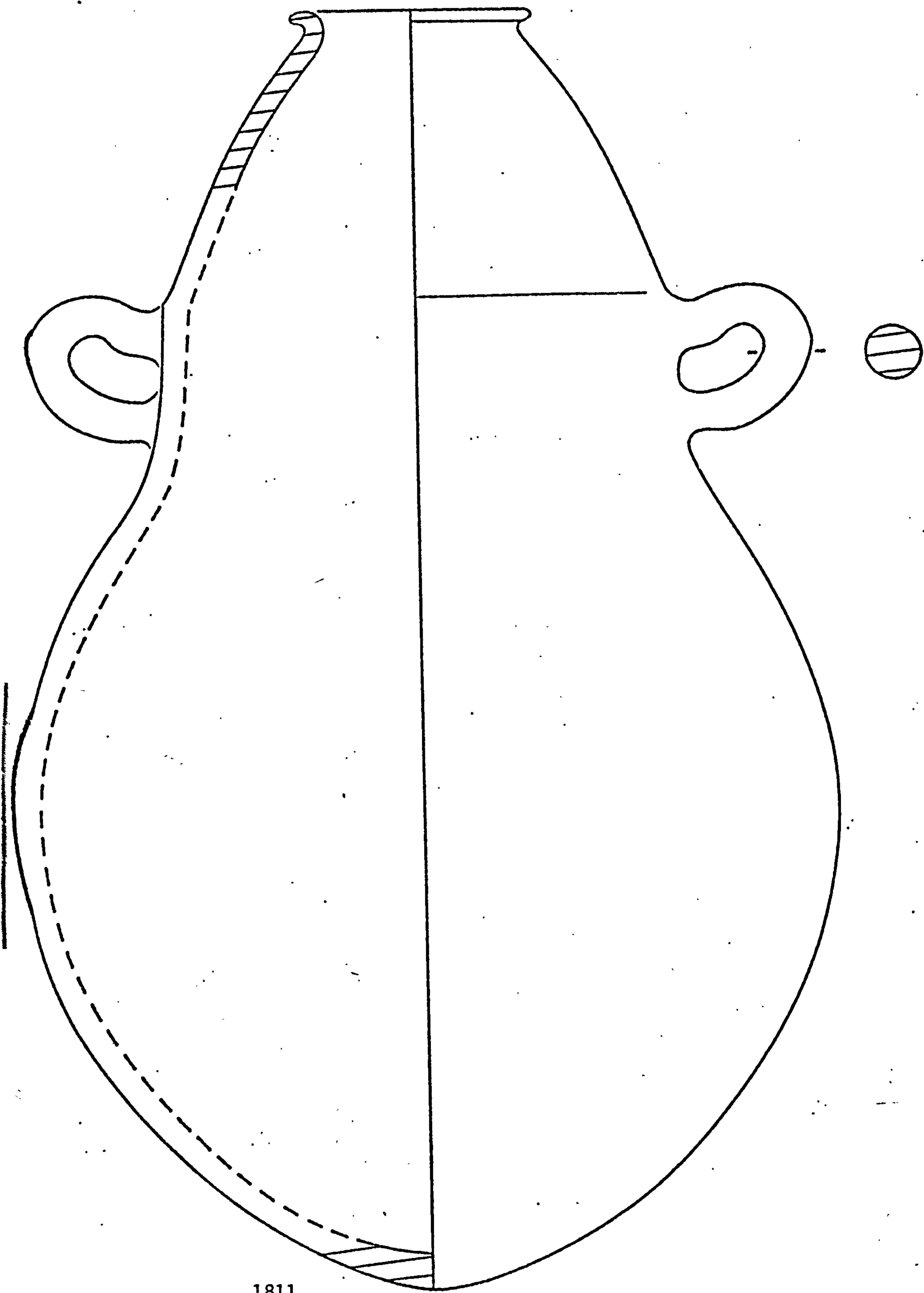

1811

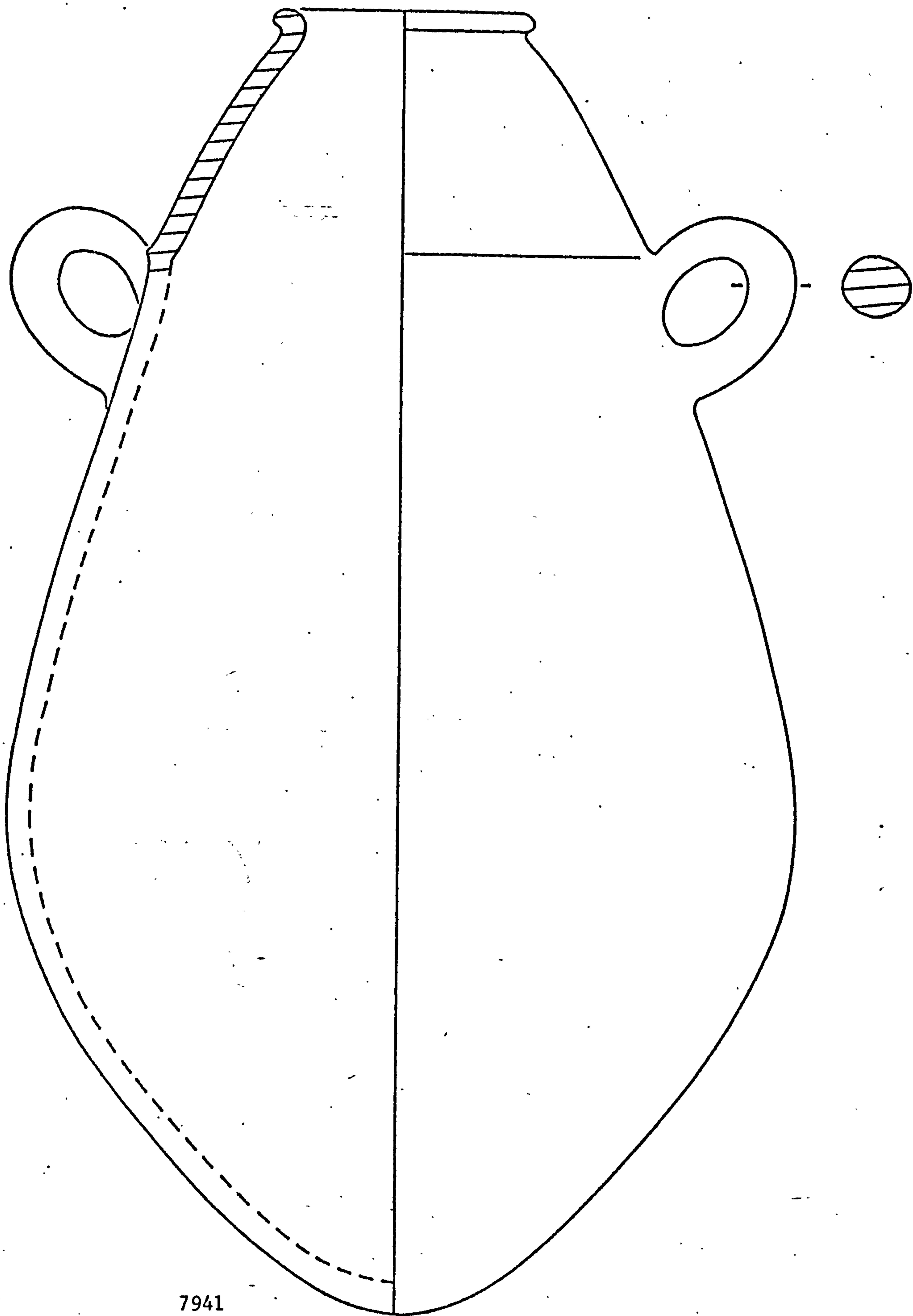

7941

Plate 37: SANTA OLAYA

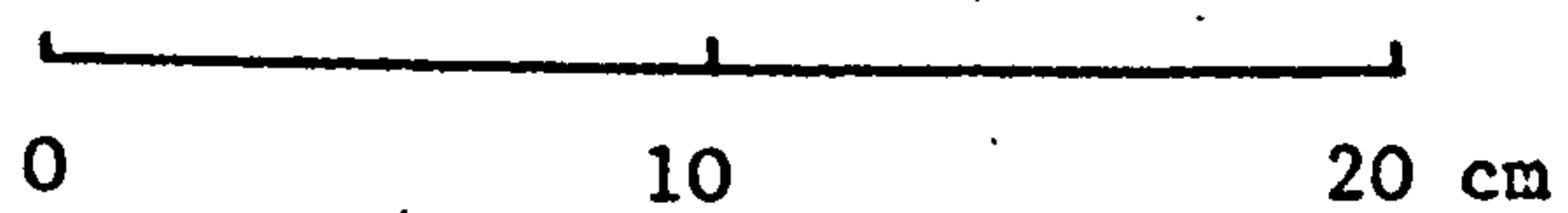

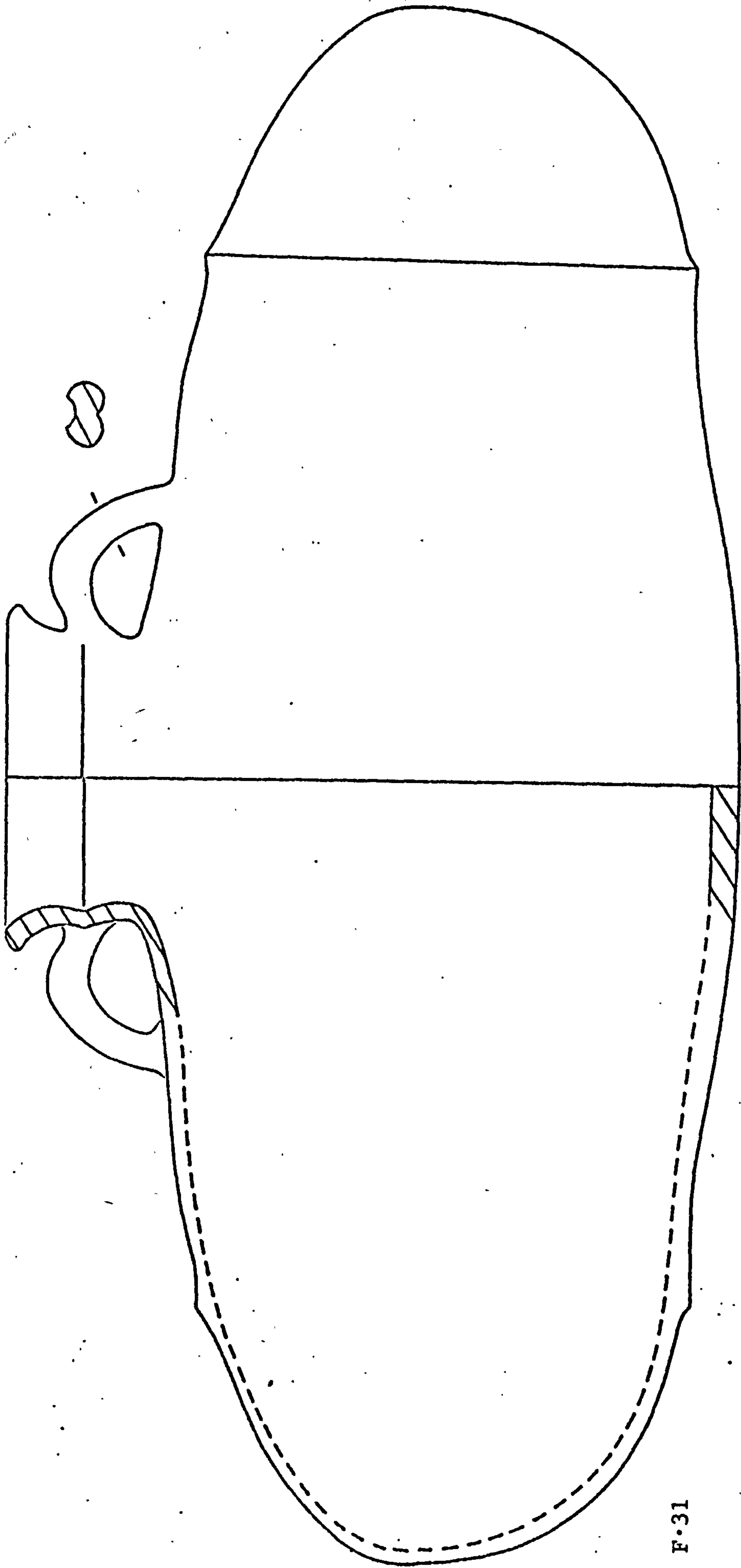

F.31



Plate 38: SANTA OLAYA

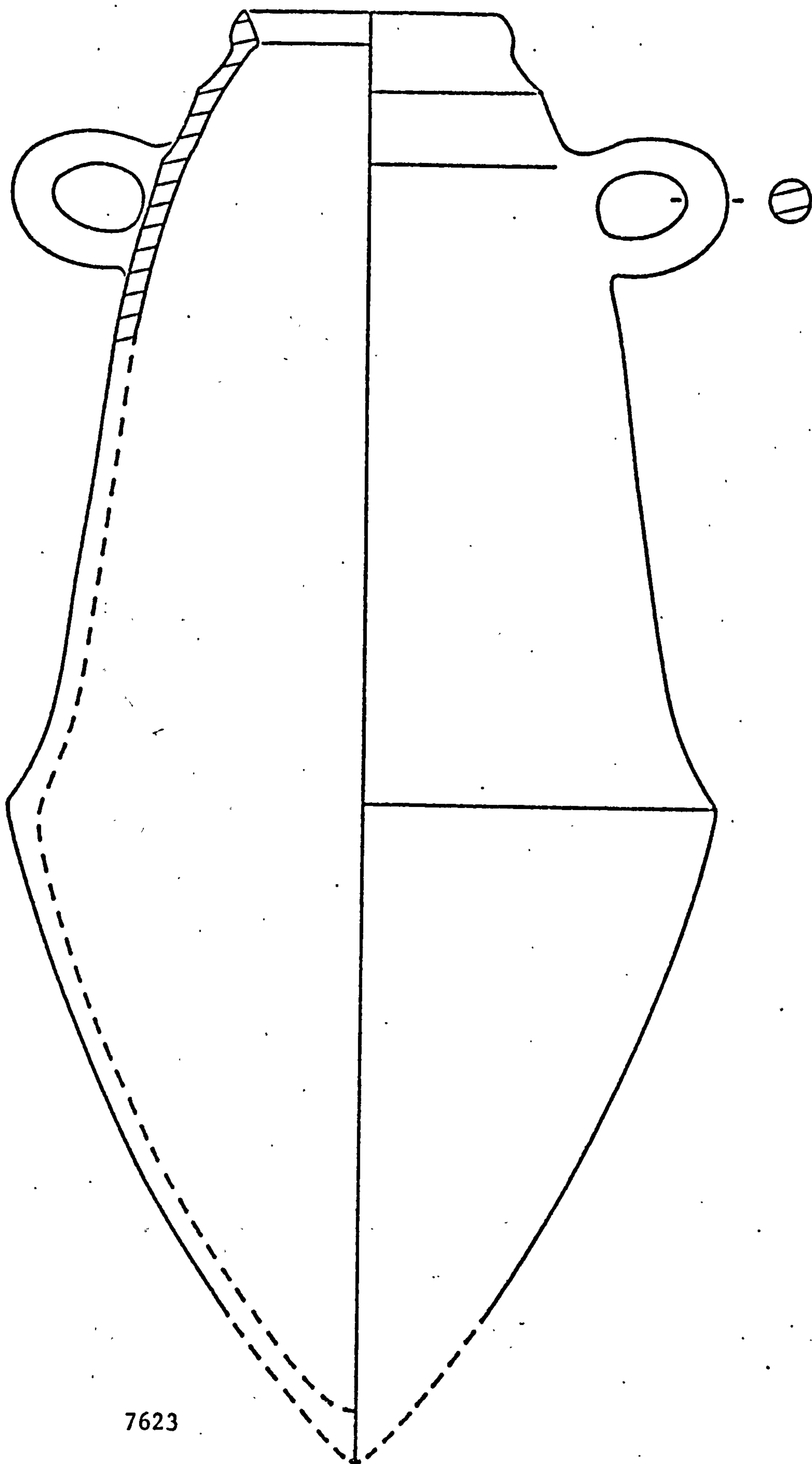

7623

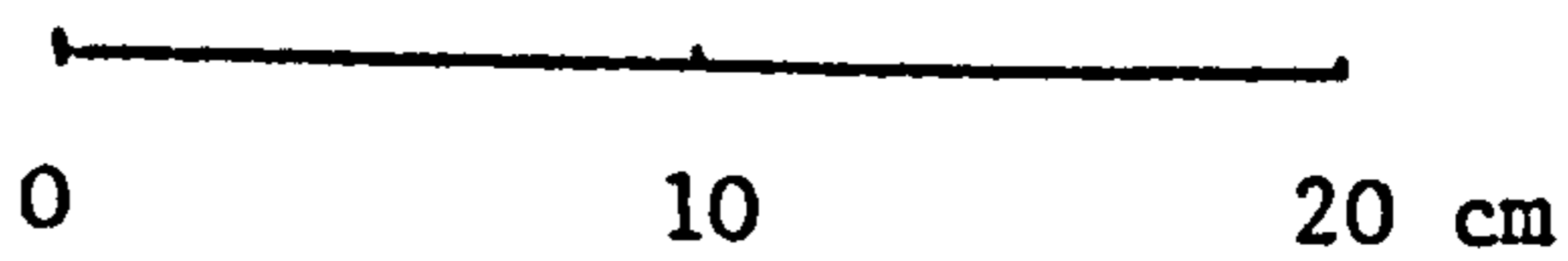
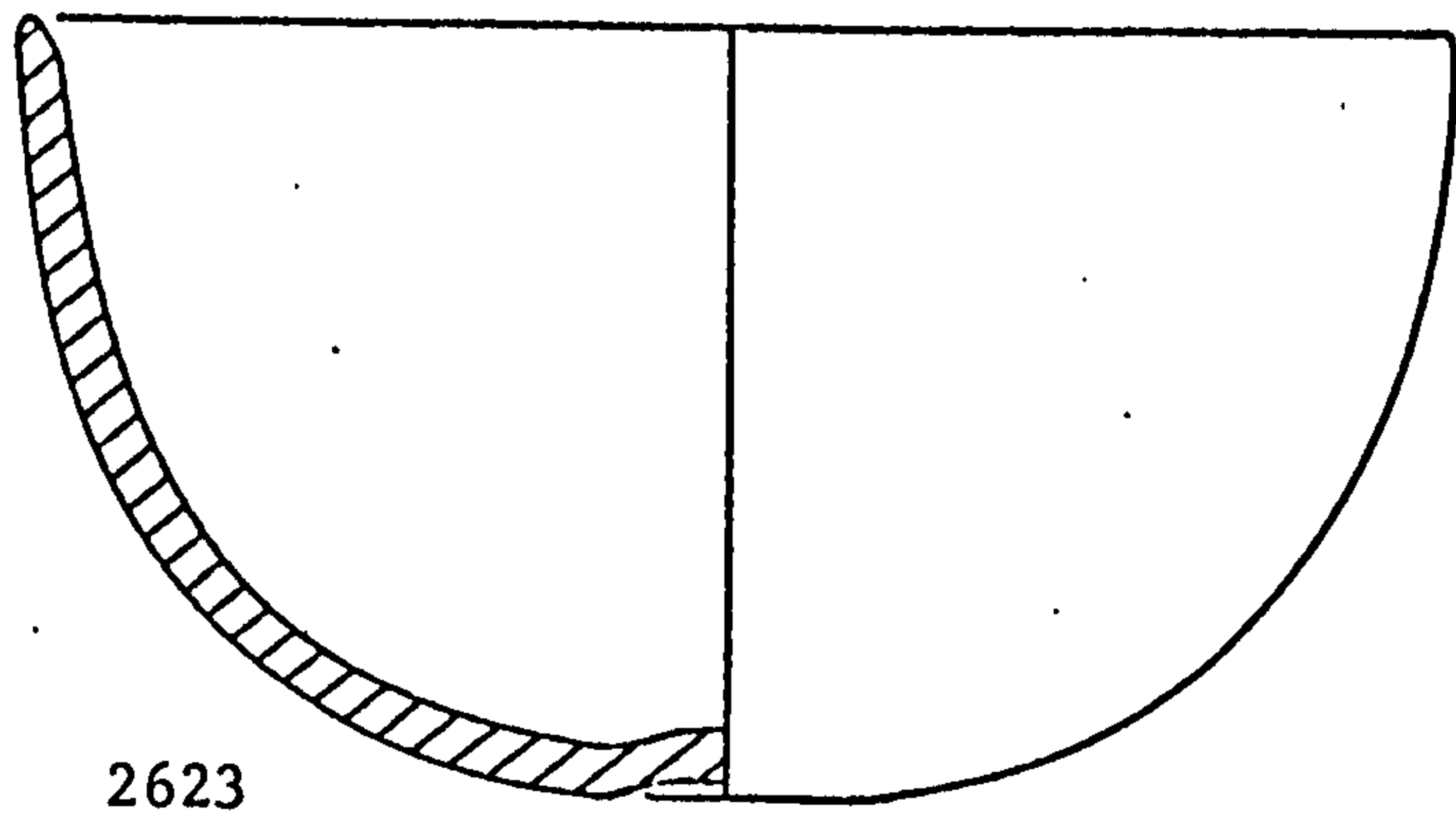
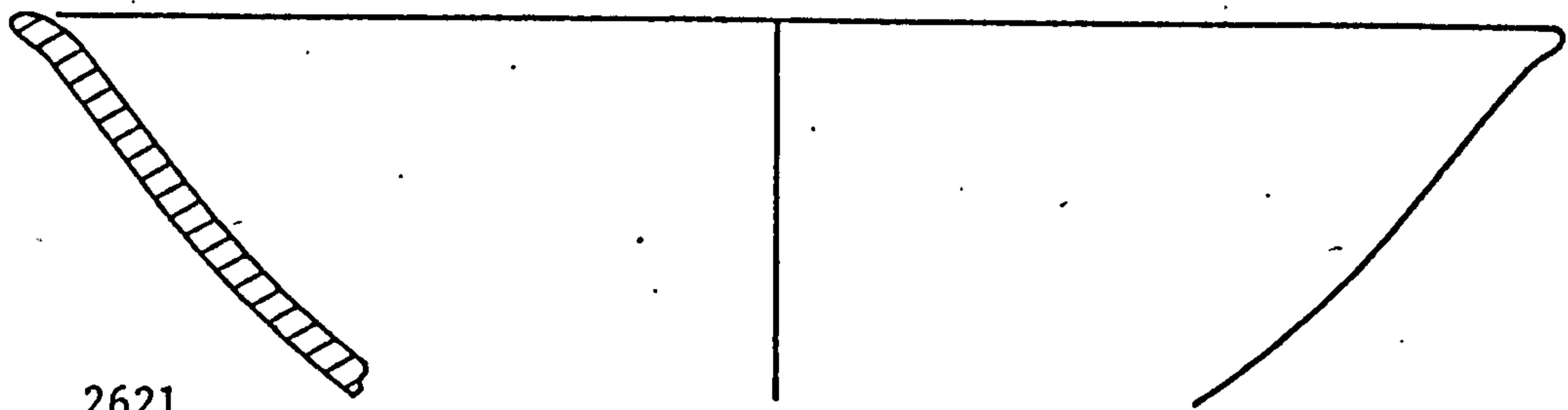

Plate 39: SANTA OLAYA



2623



2621

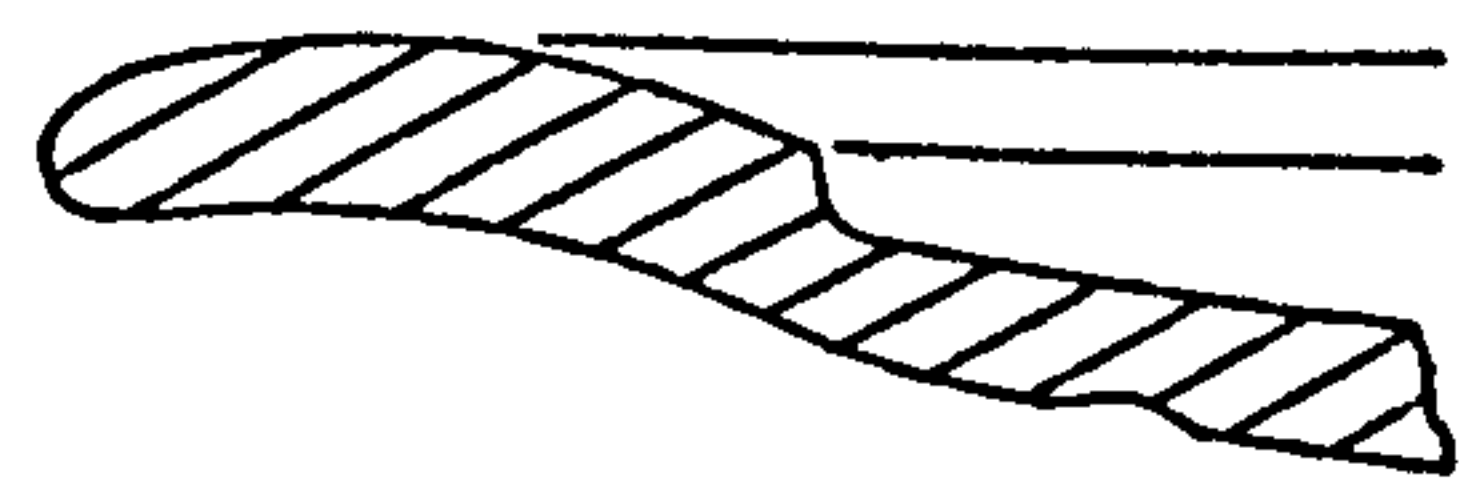

2566

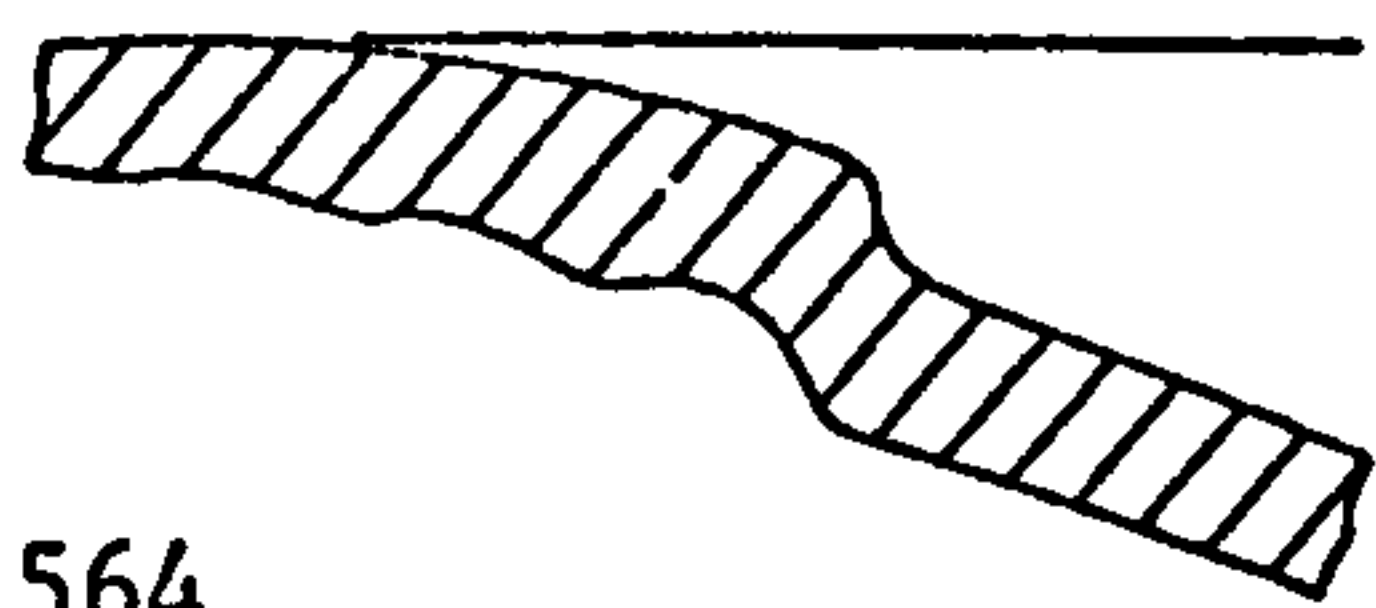

2564

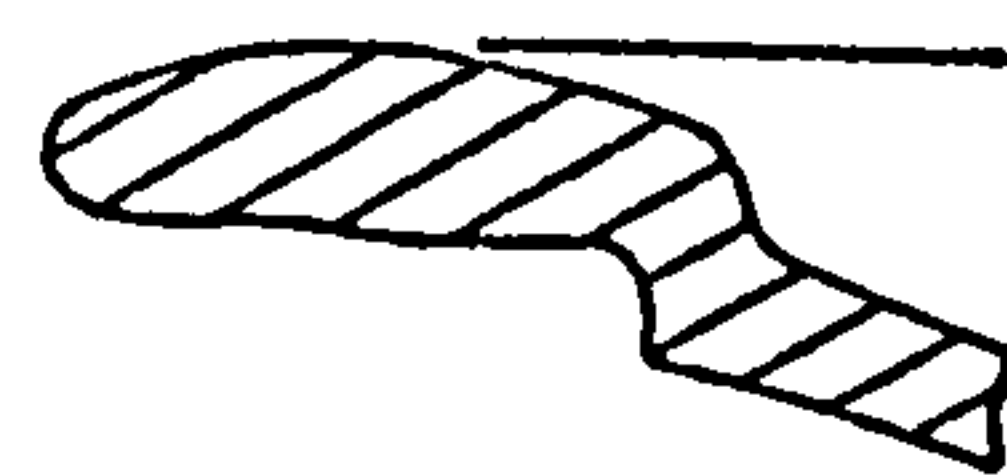

2567

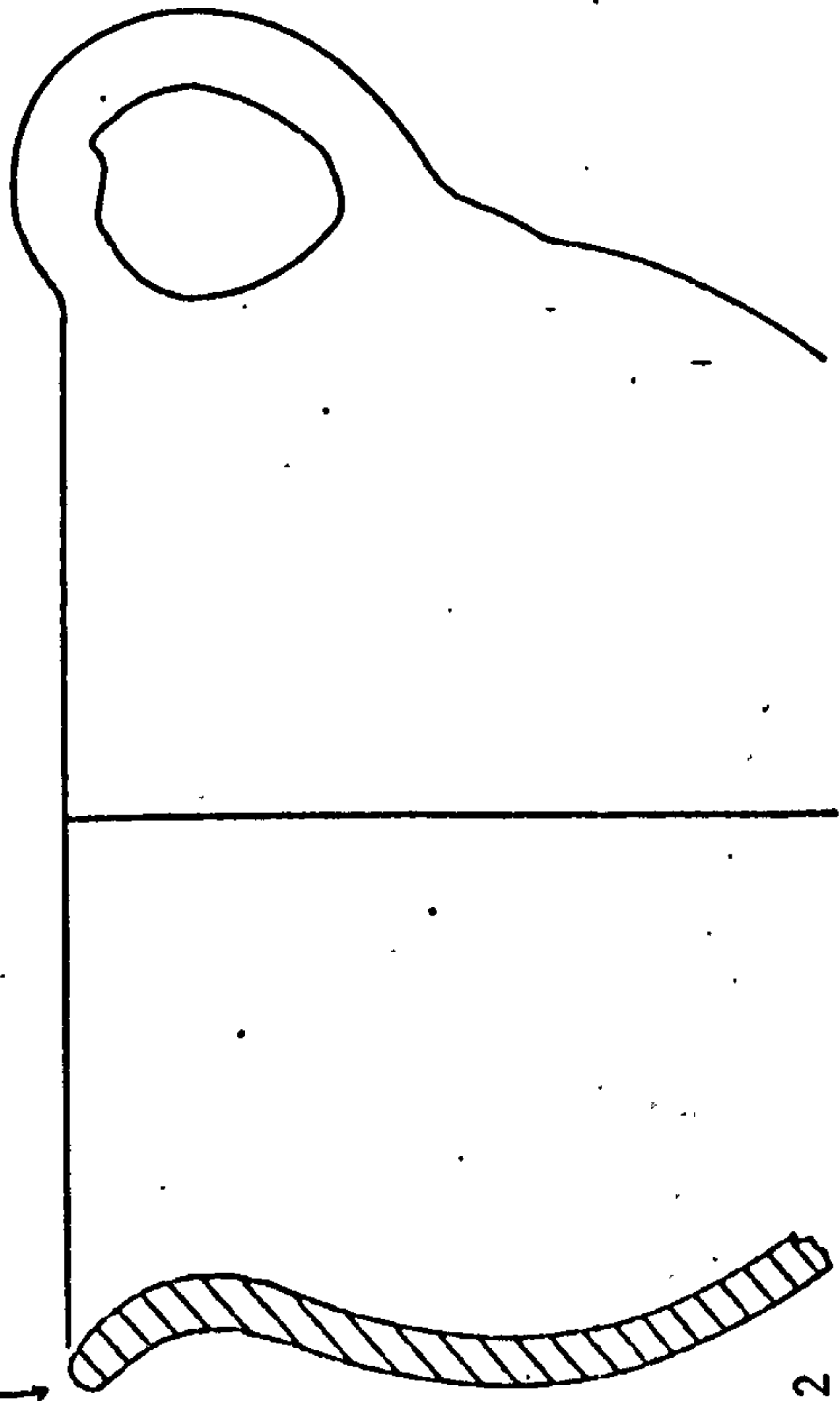

2282

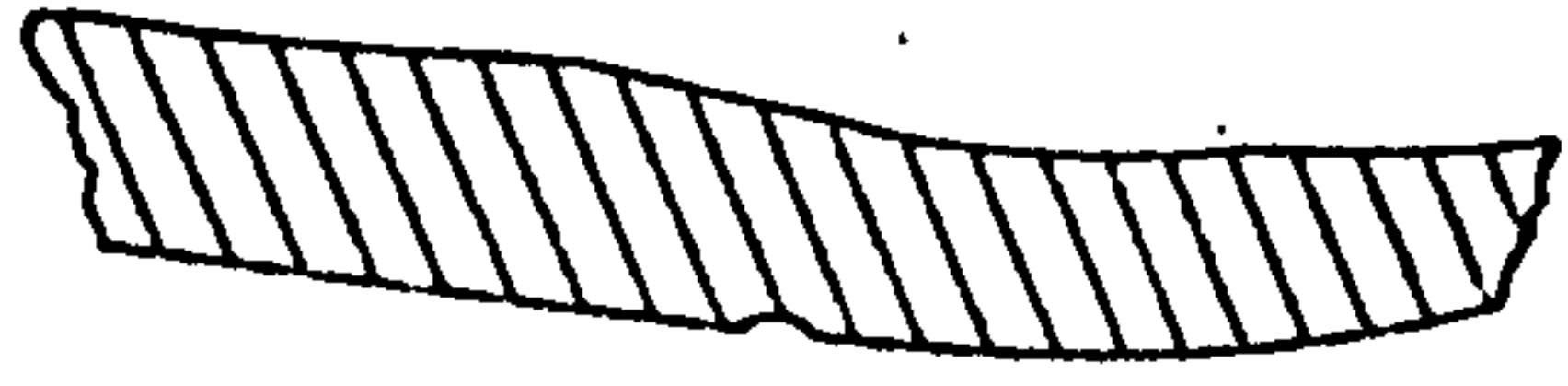
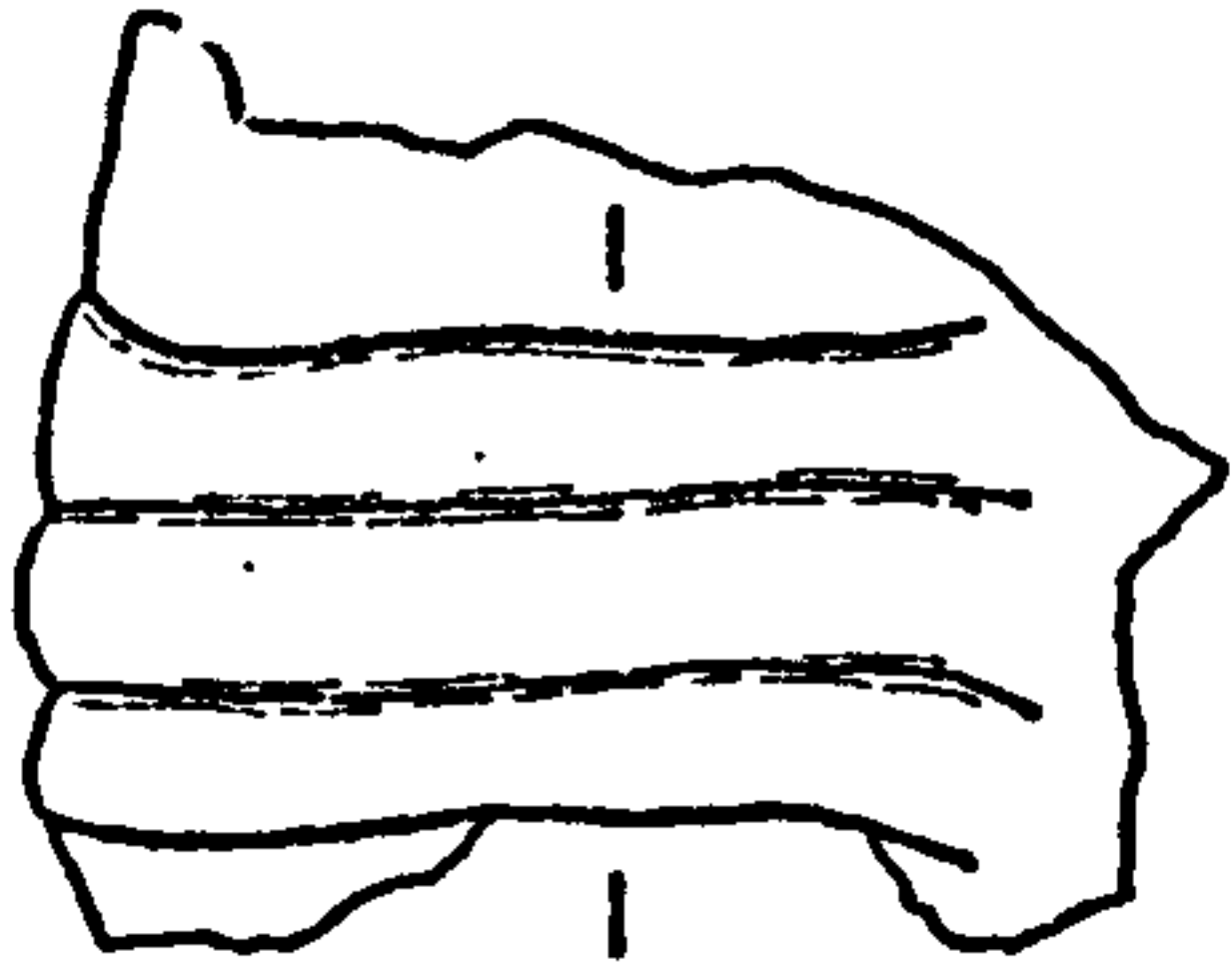

2277

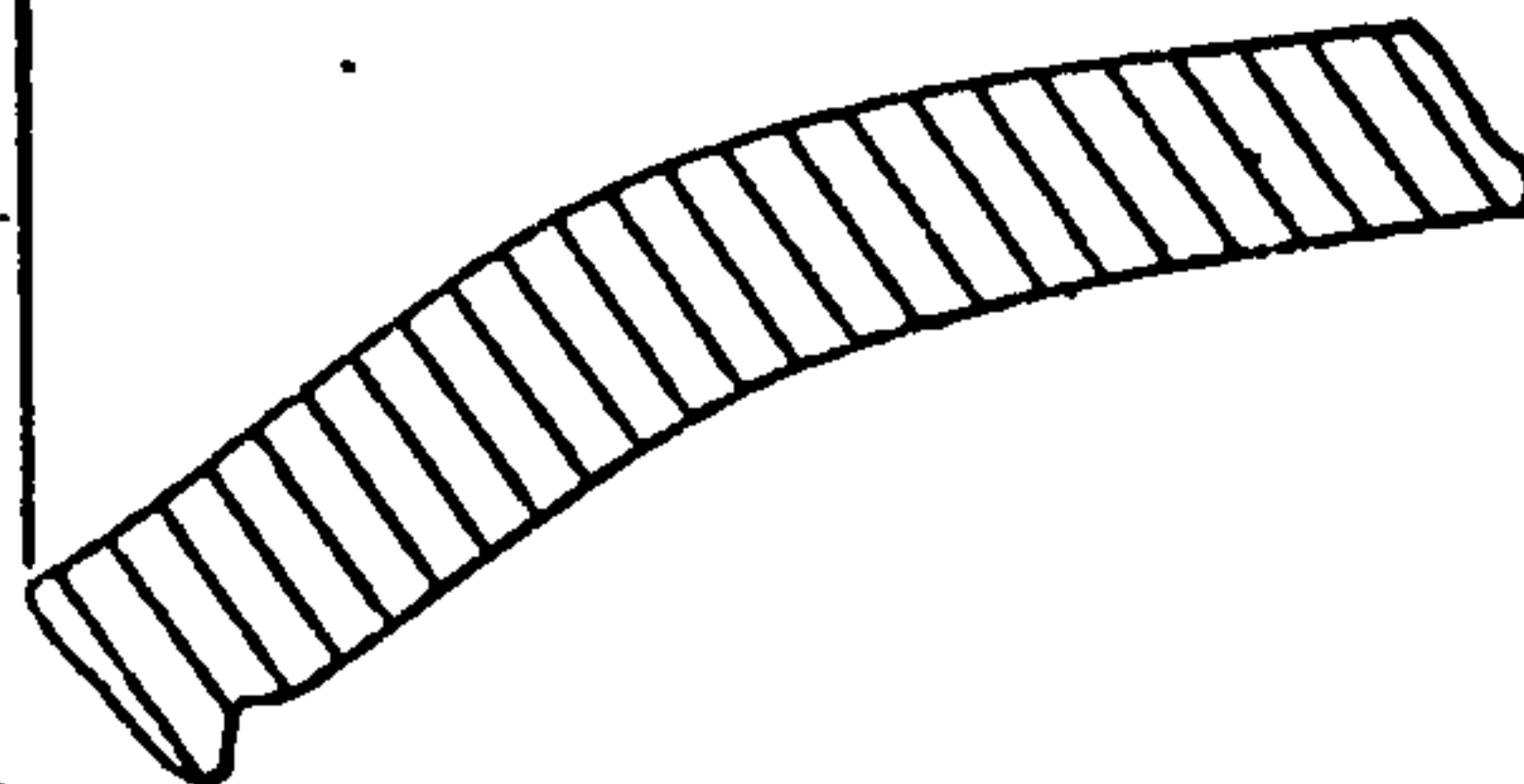
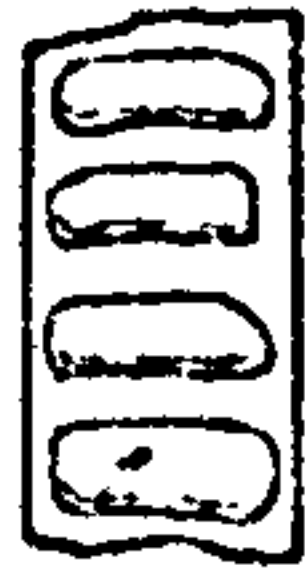
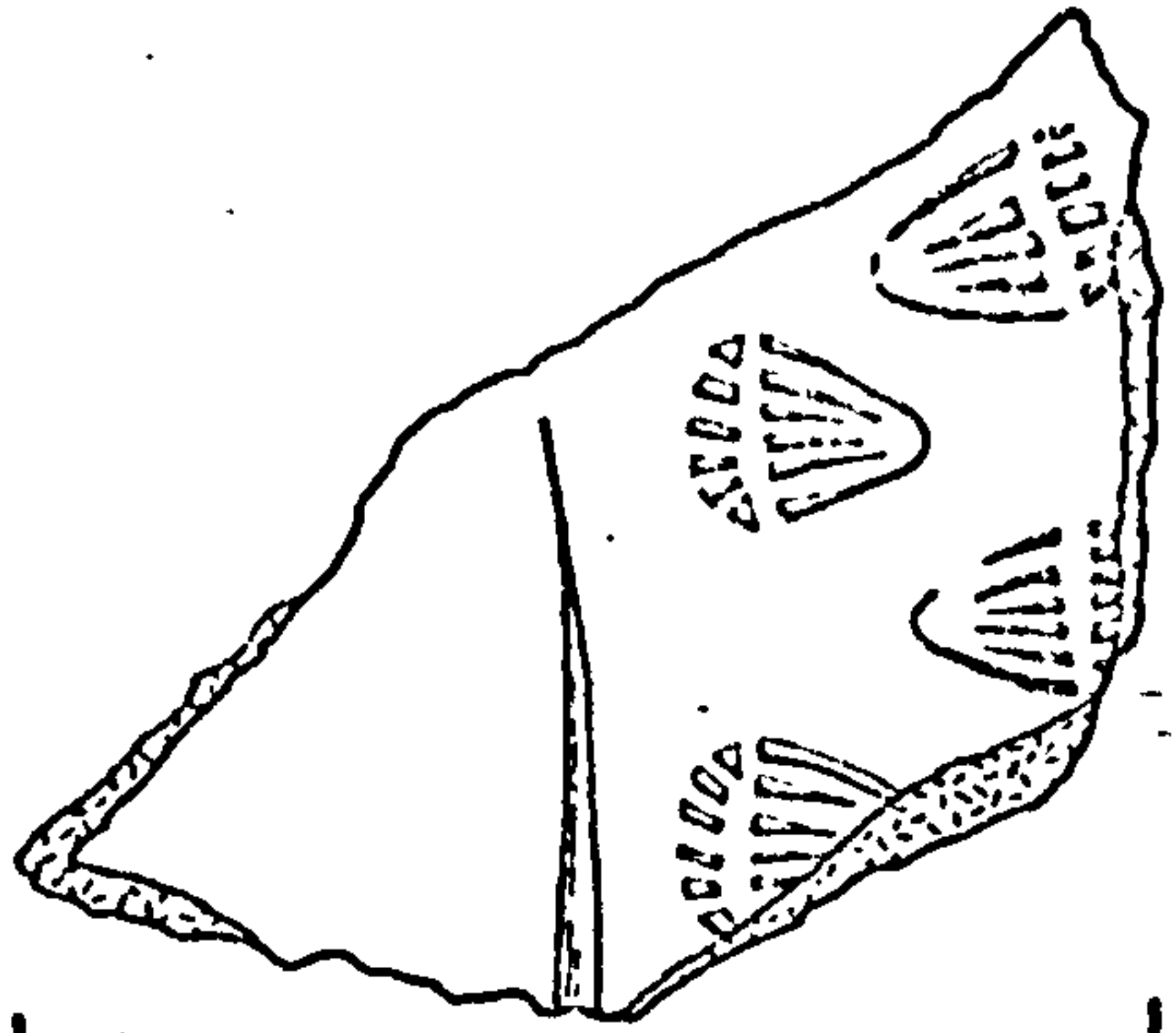

2596

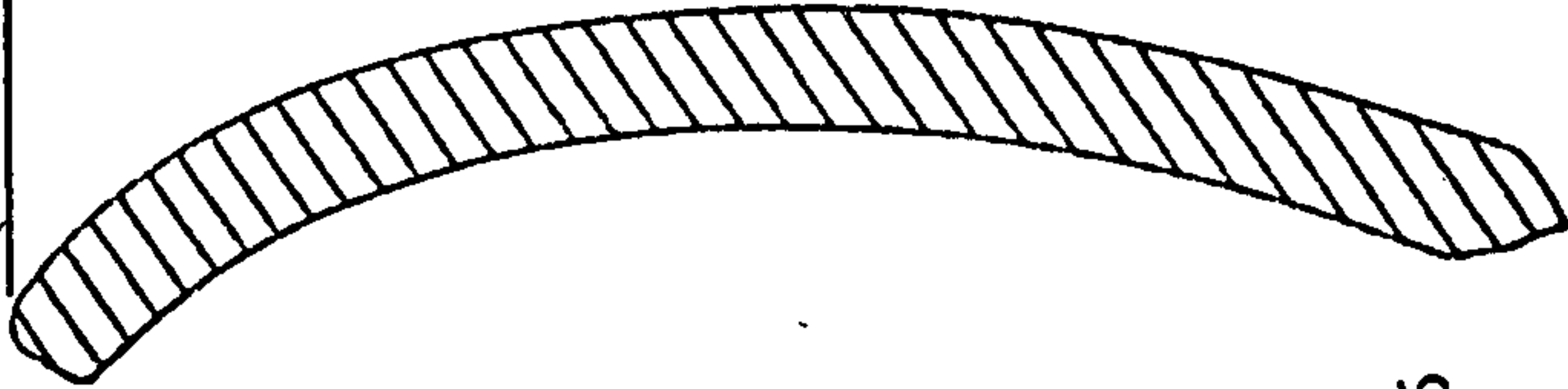

6376



2597

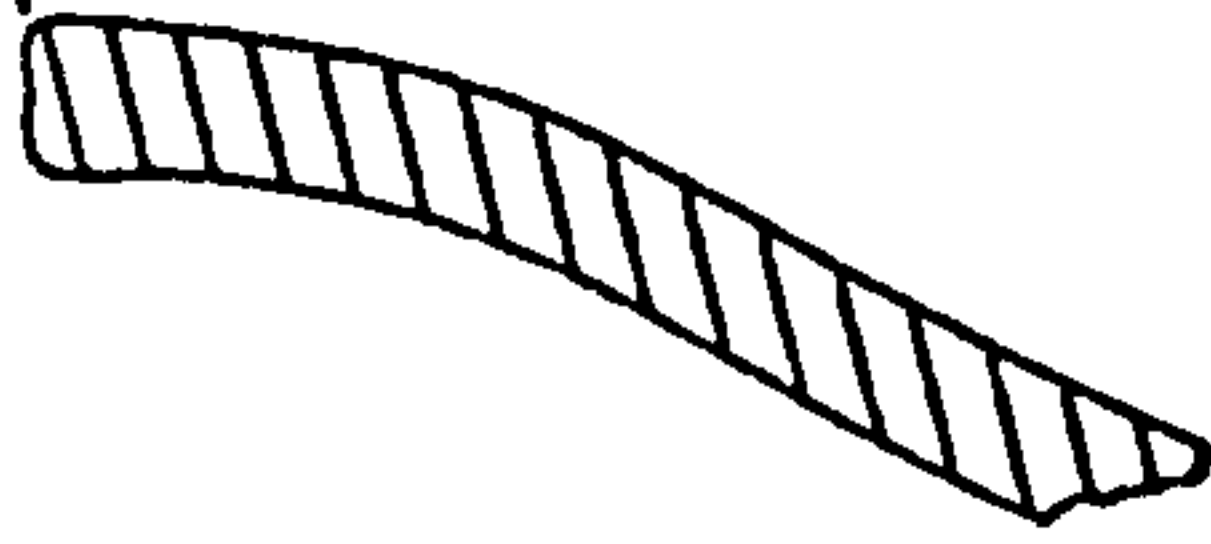

2398

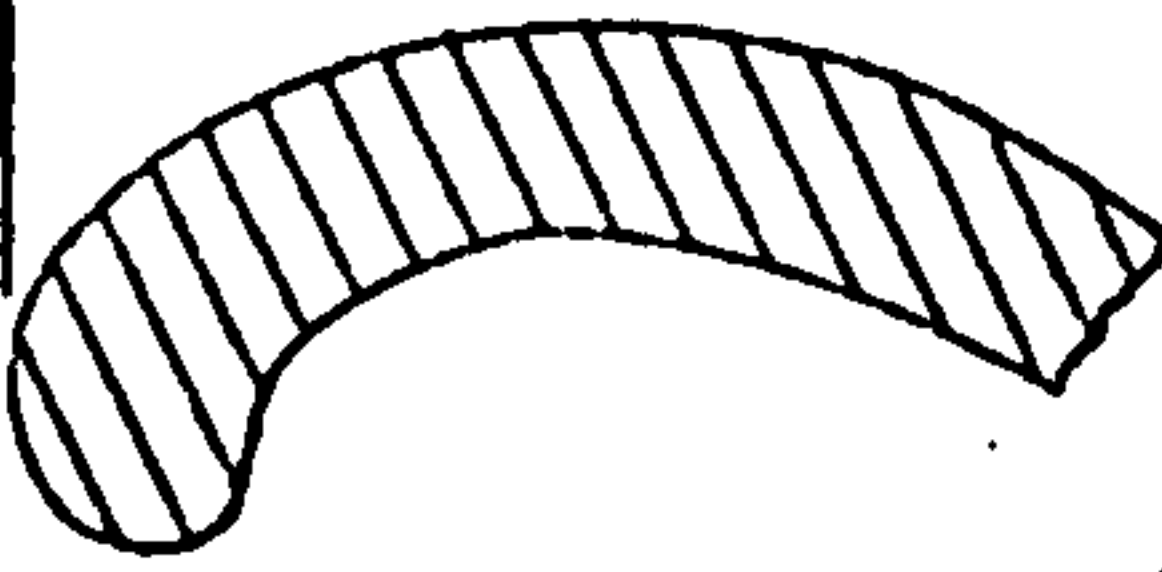

2358

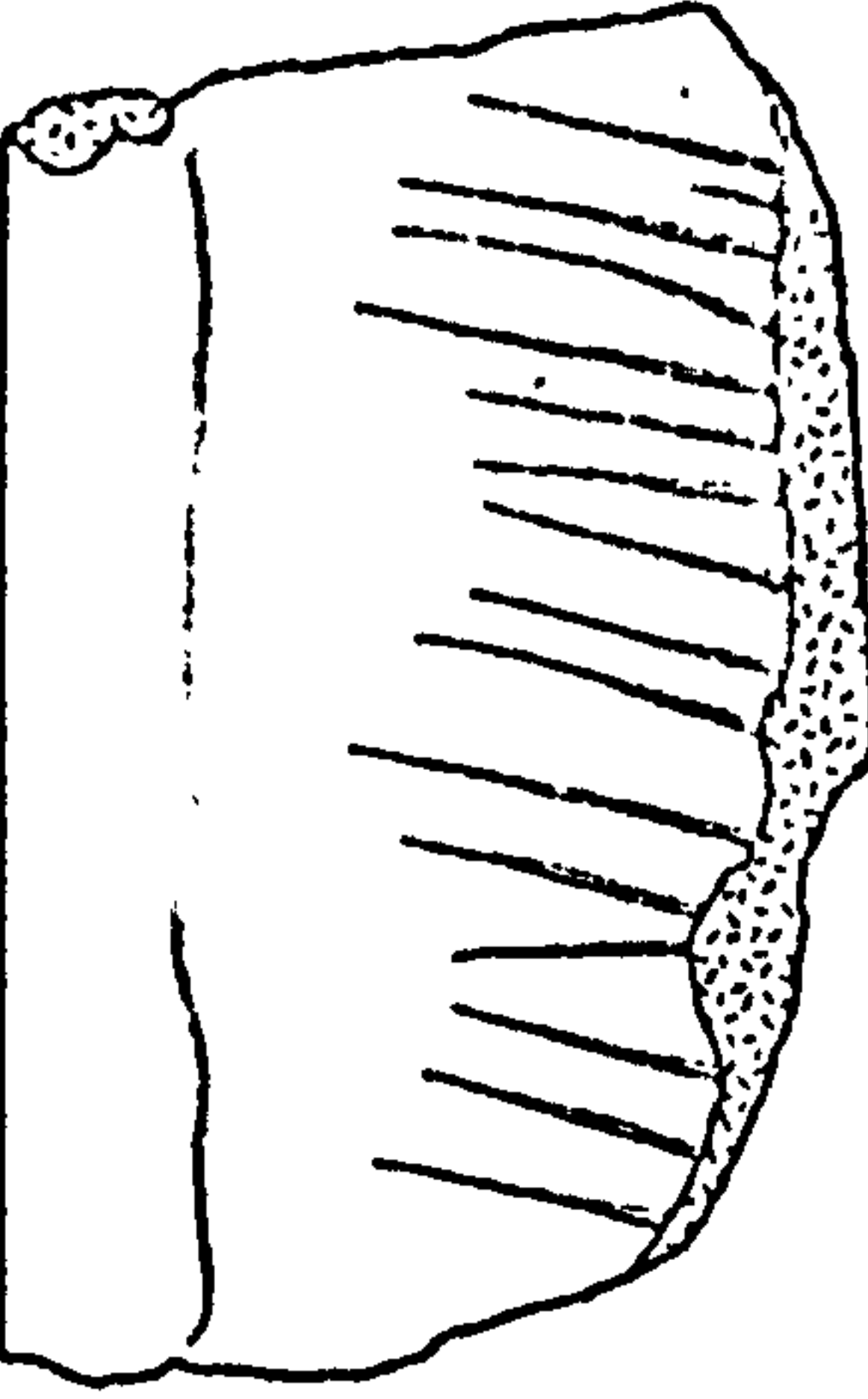

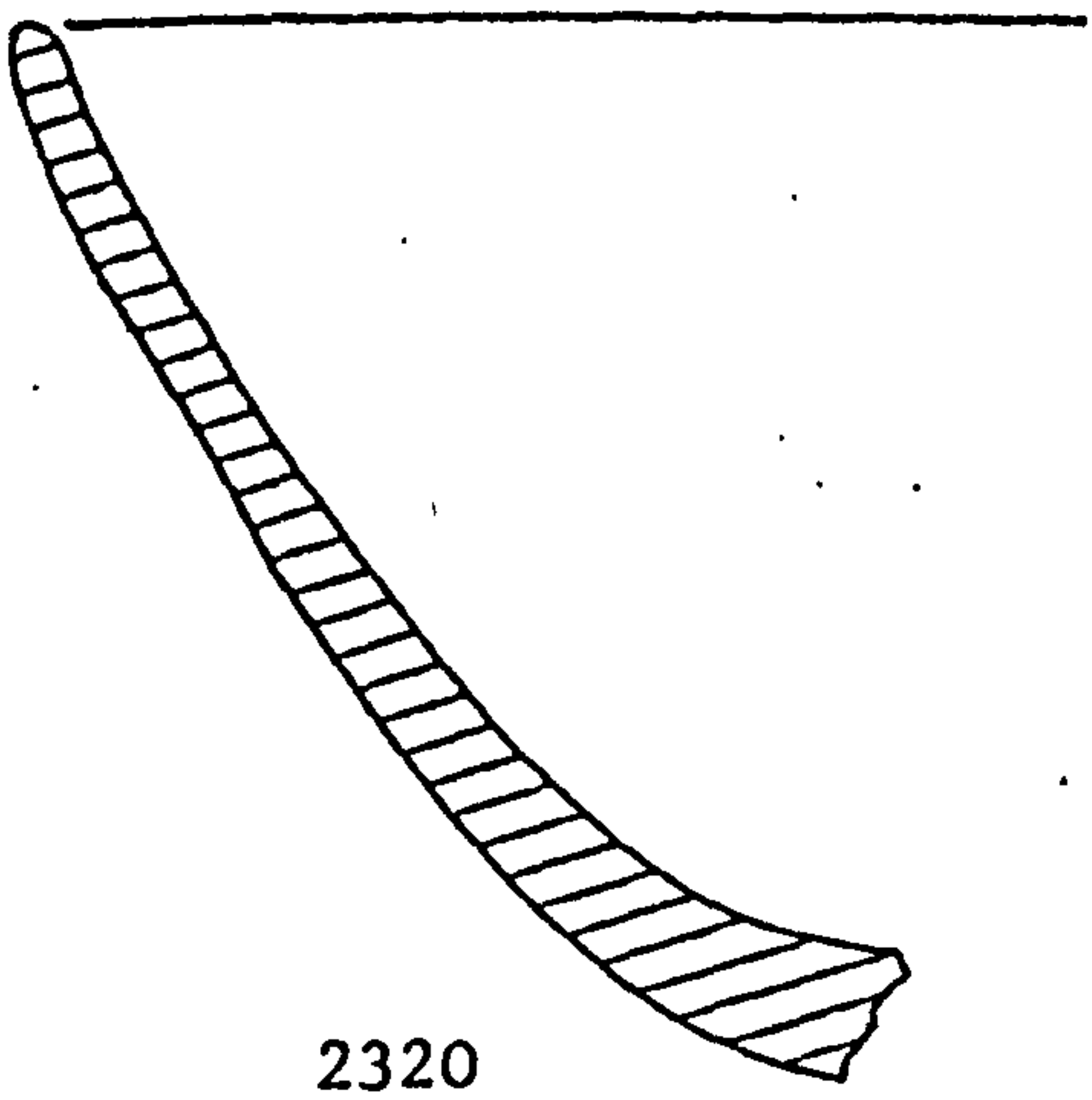

2320

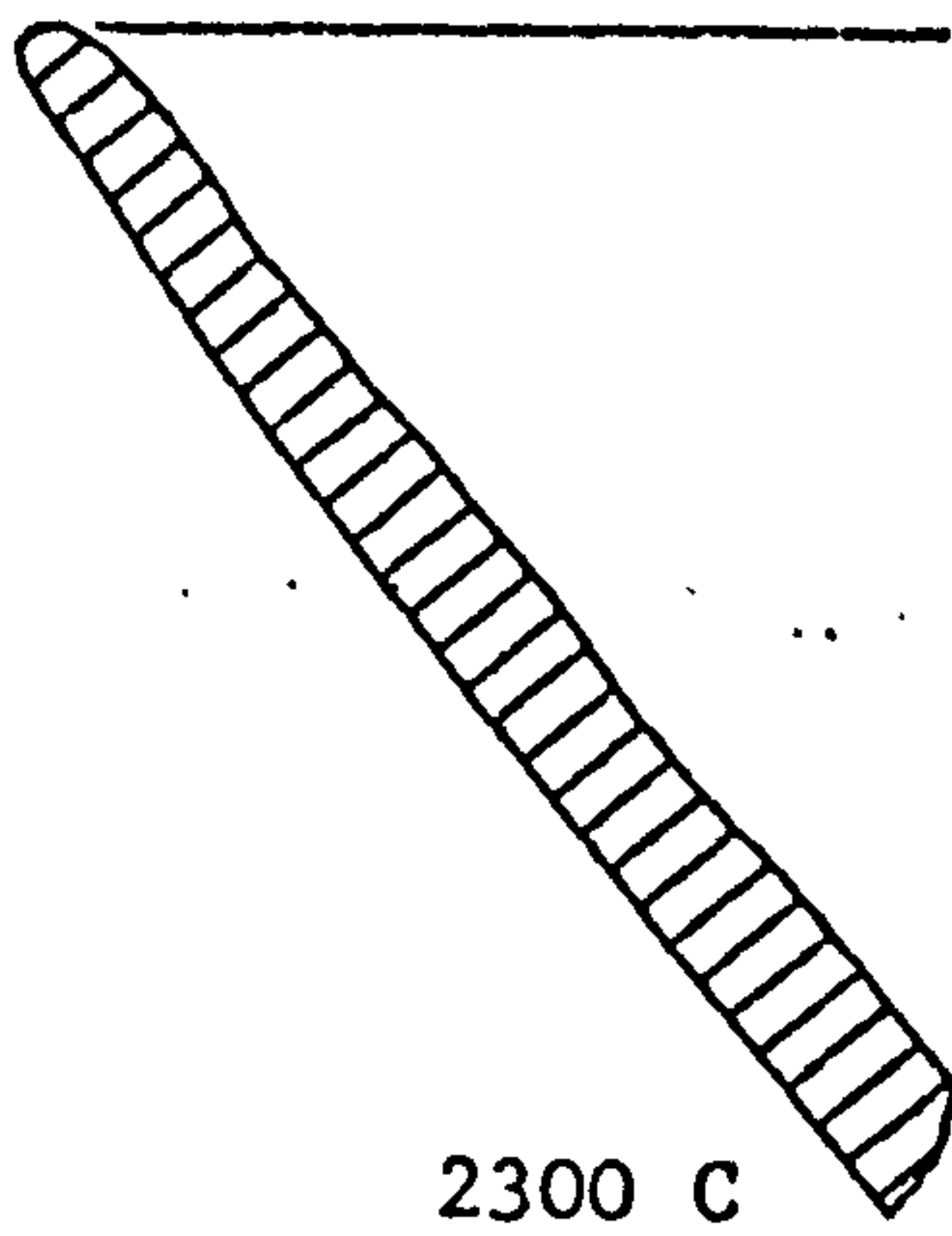

2300 C

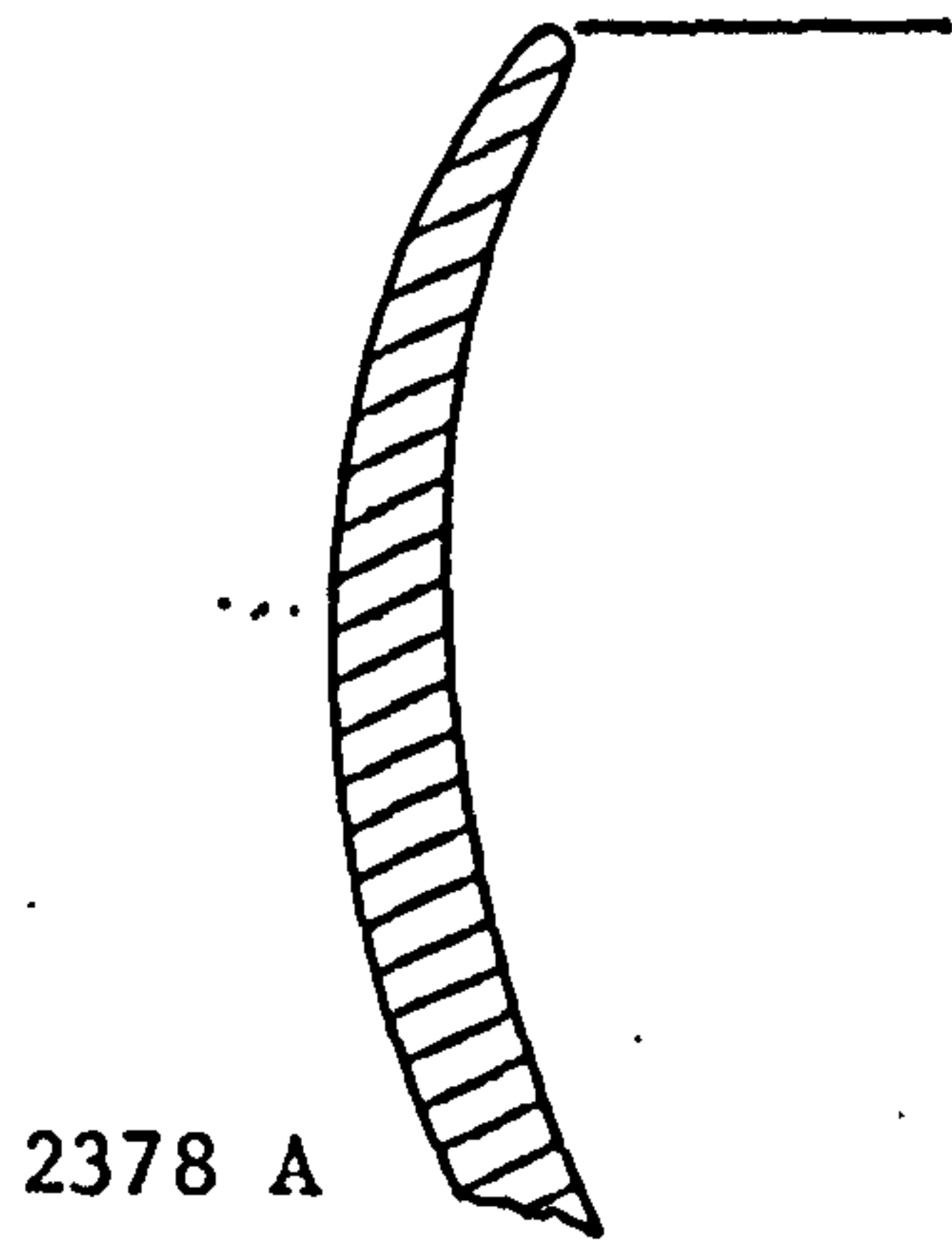

2378 A

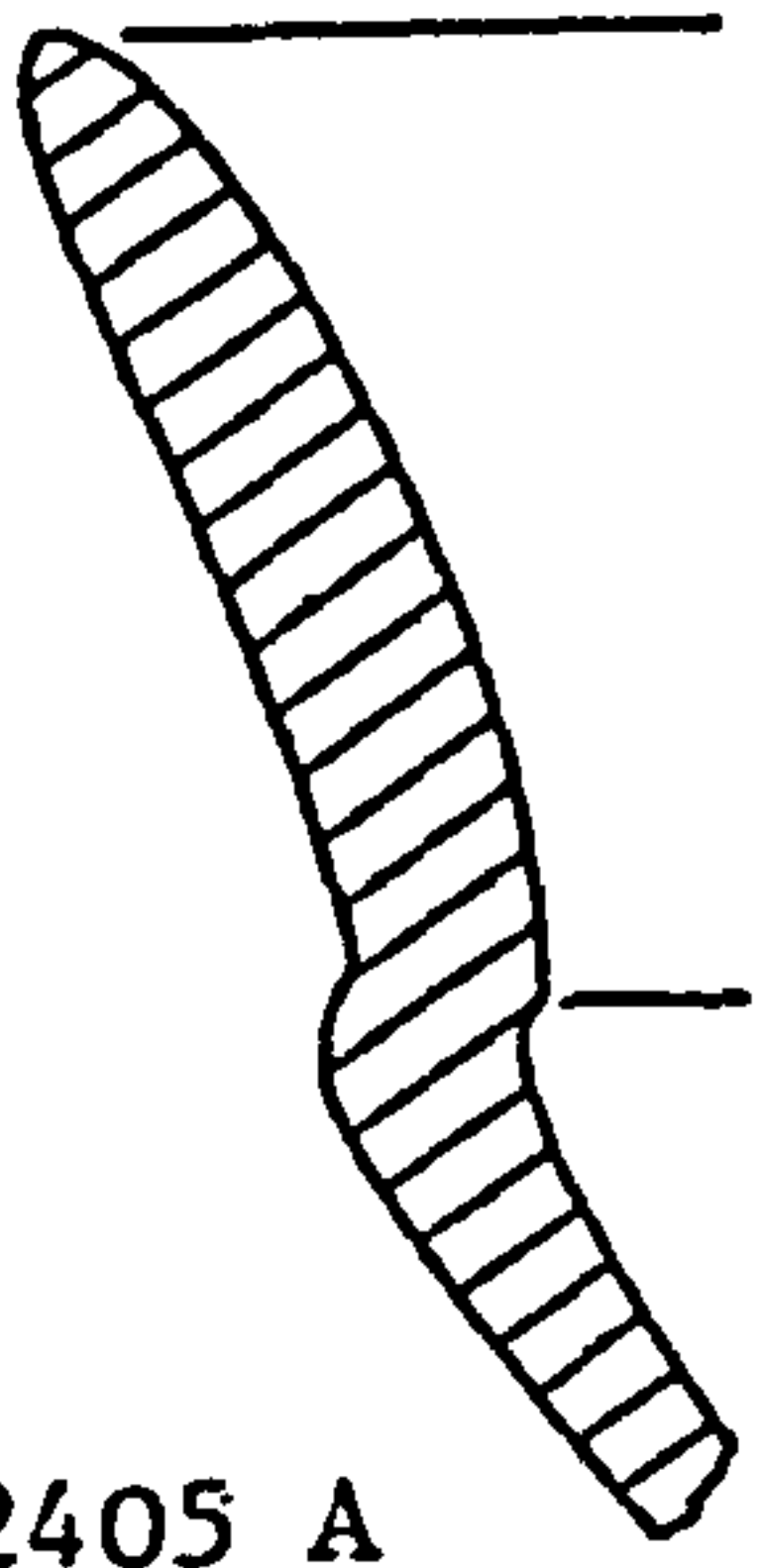

2405 A

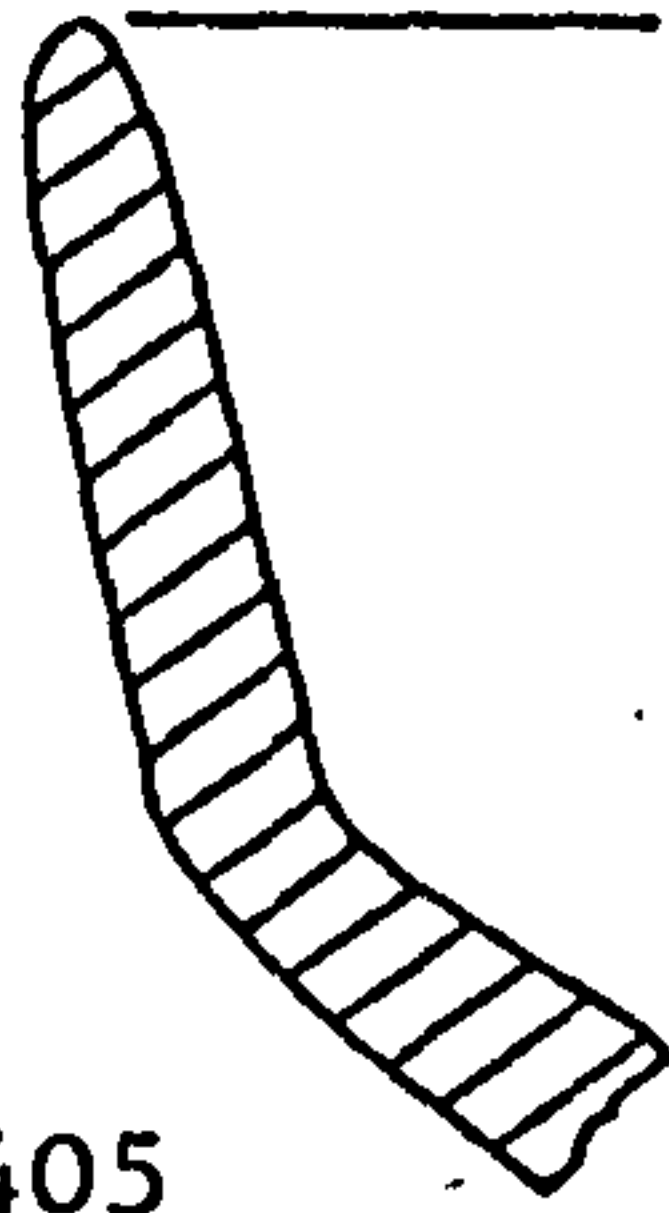

2405

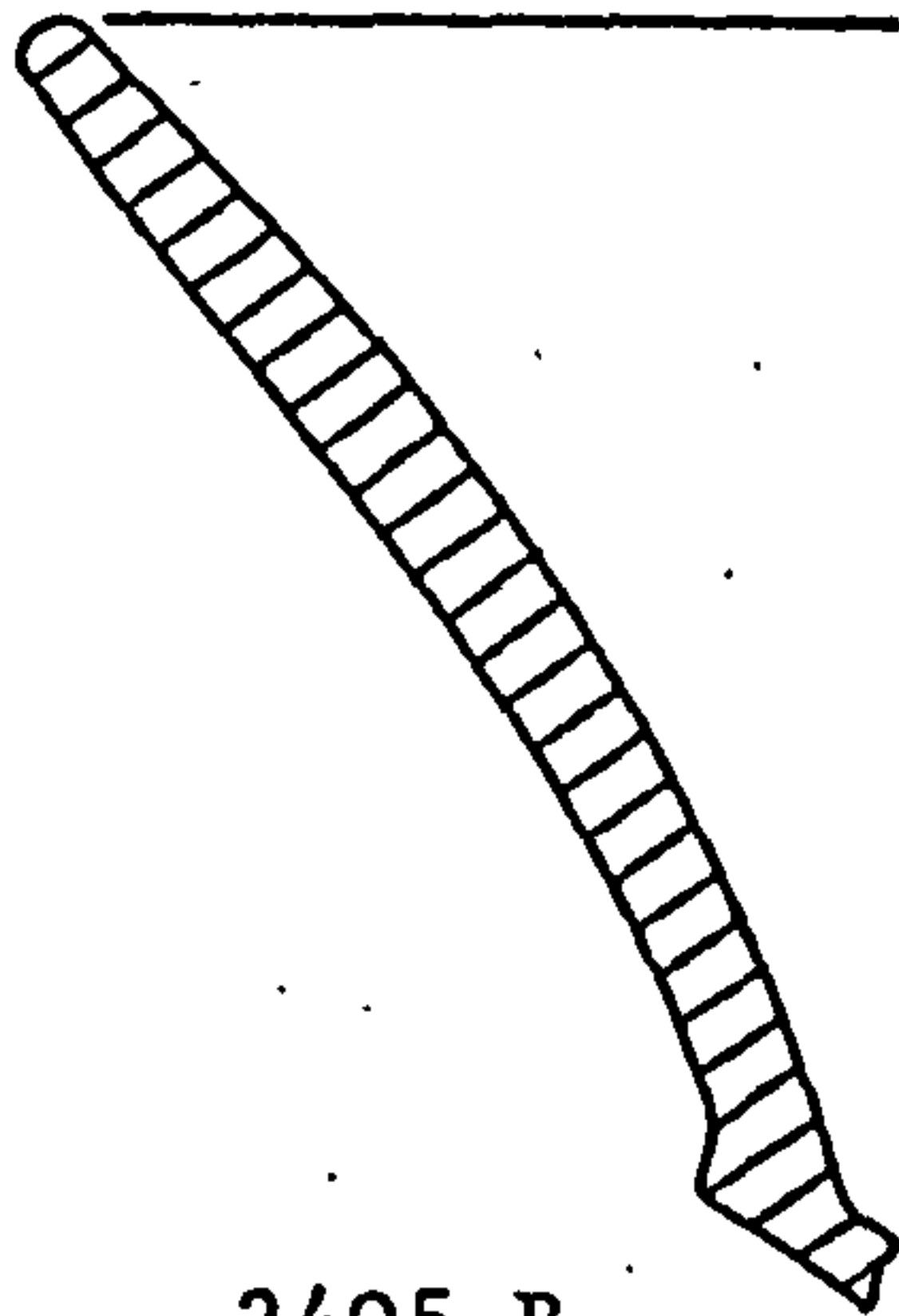

2405 B

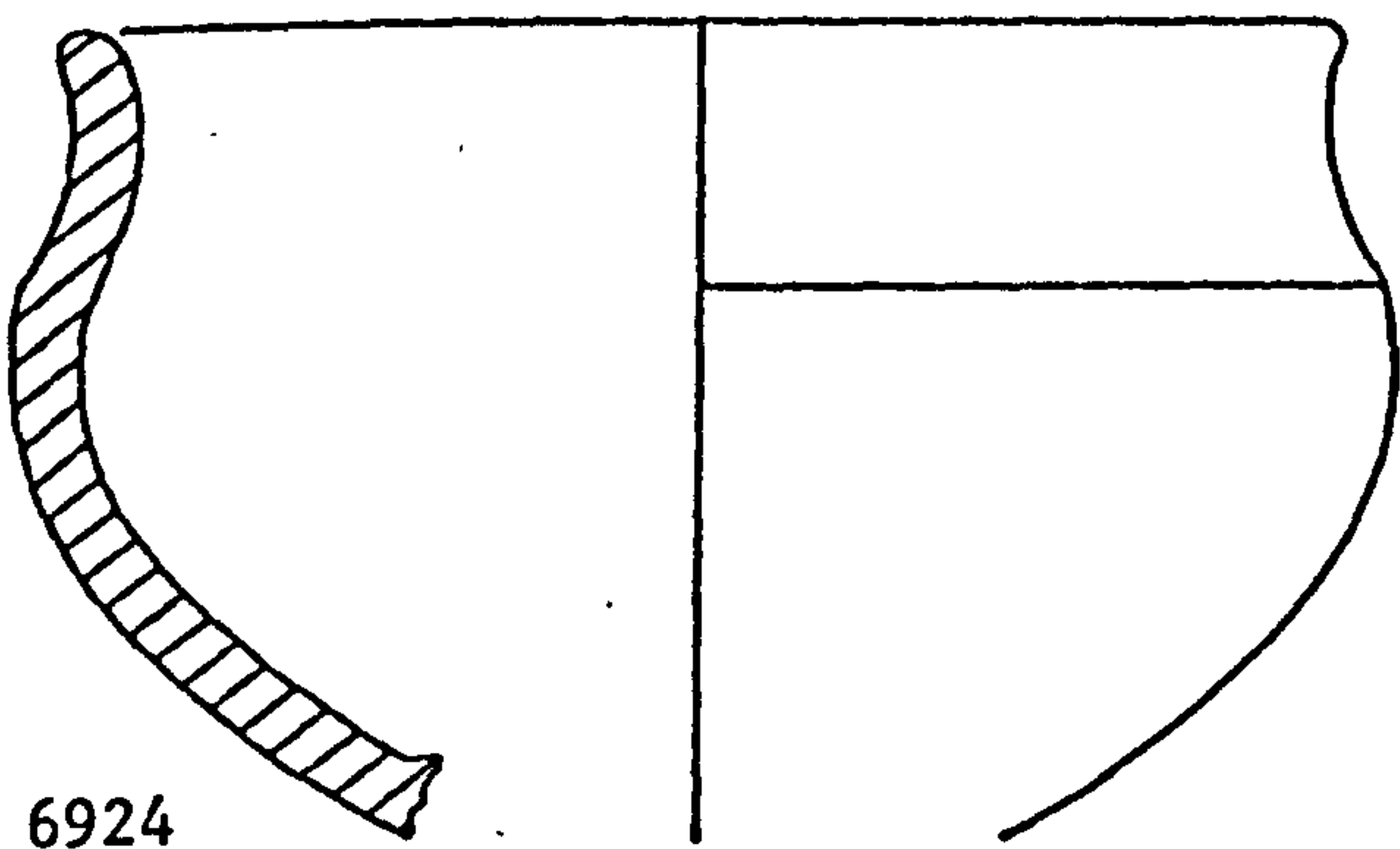

6924

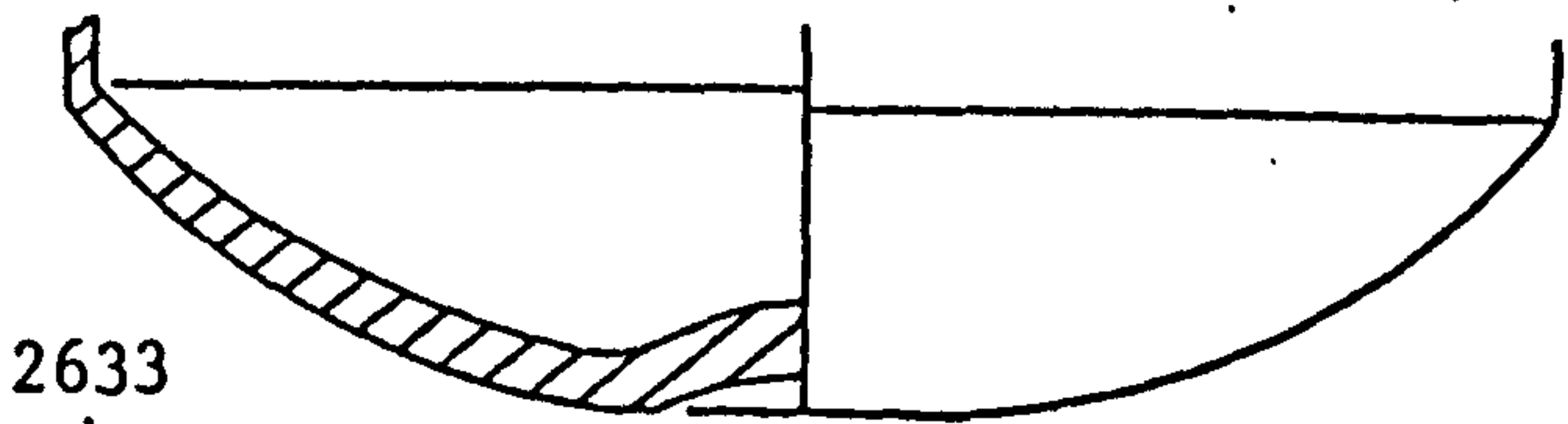

2633

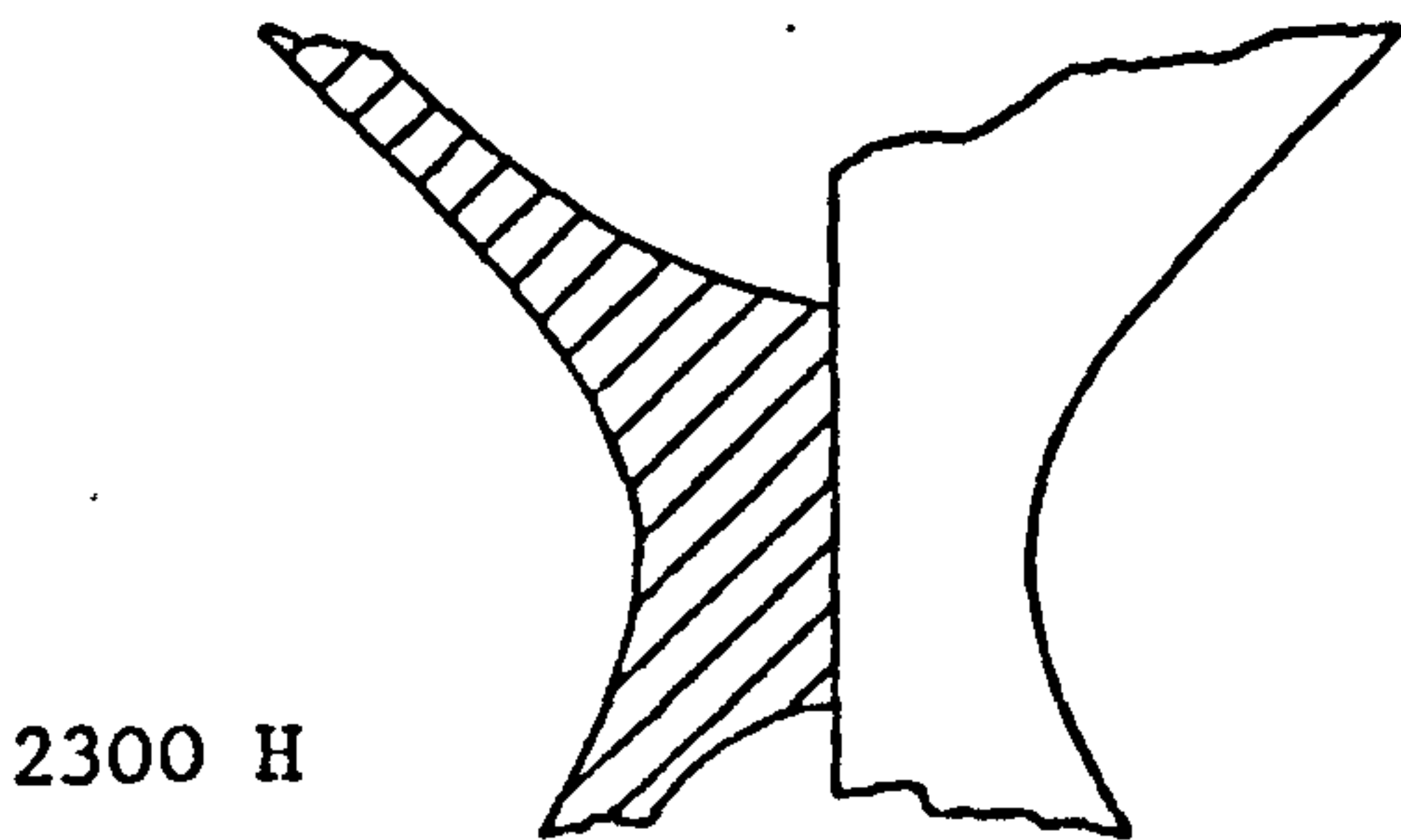

2300 H

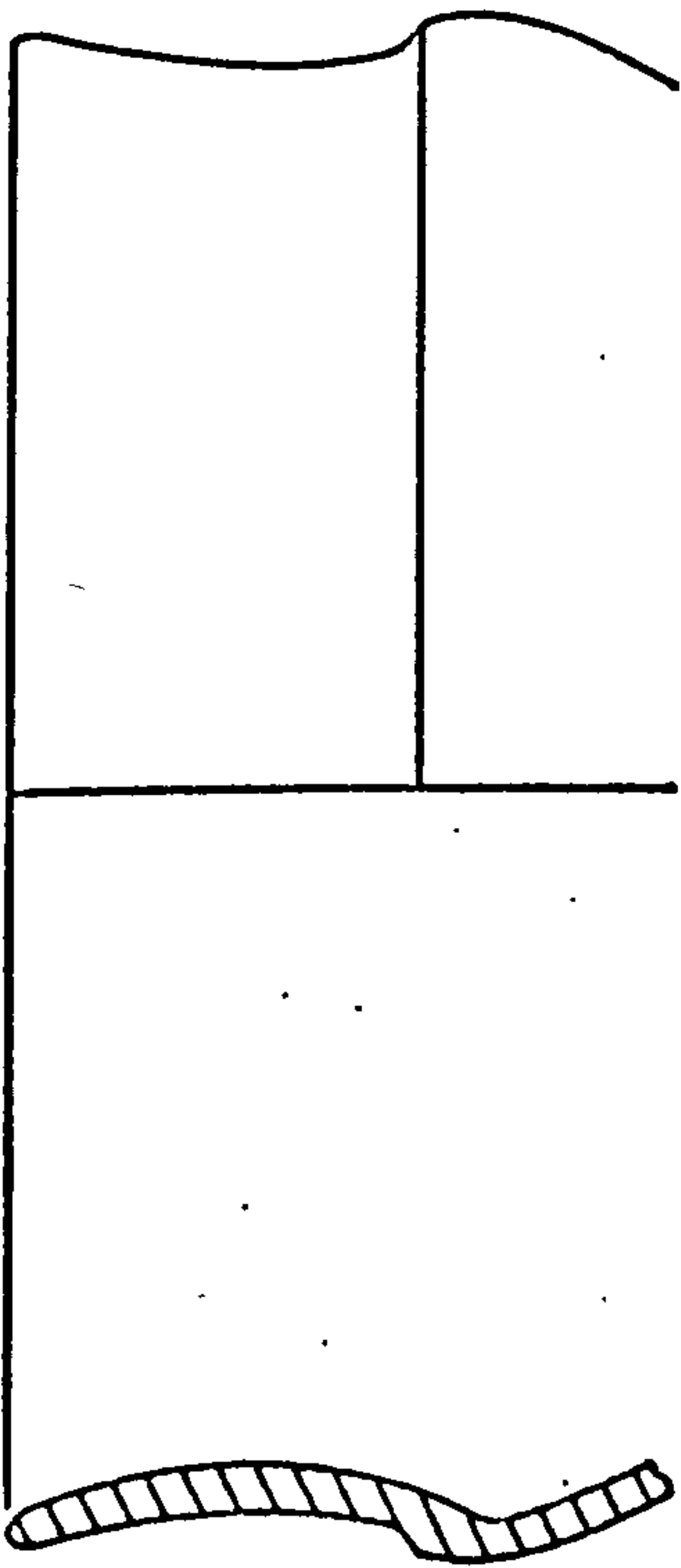

2428

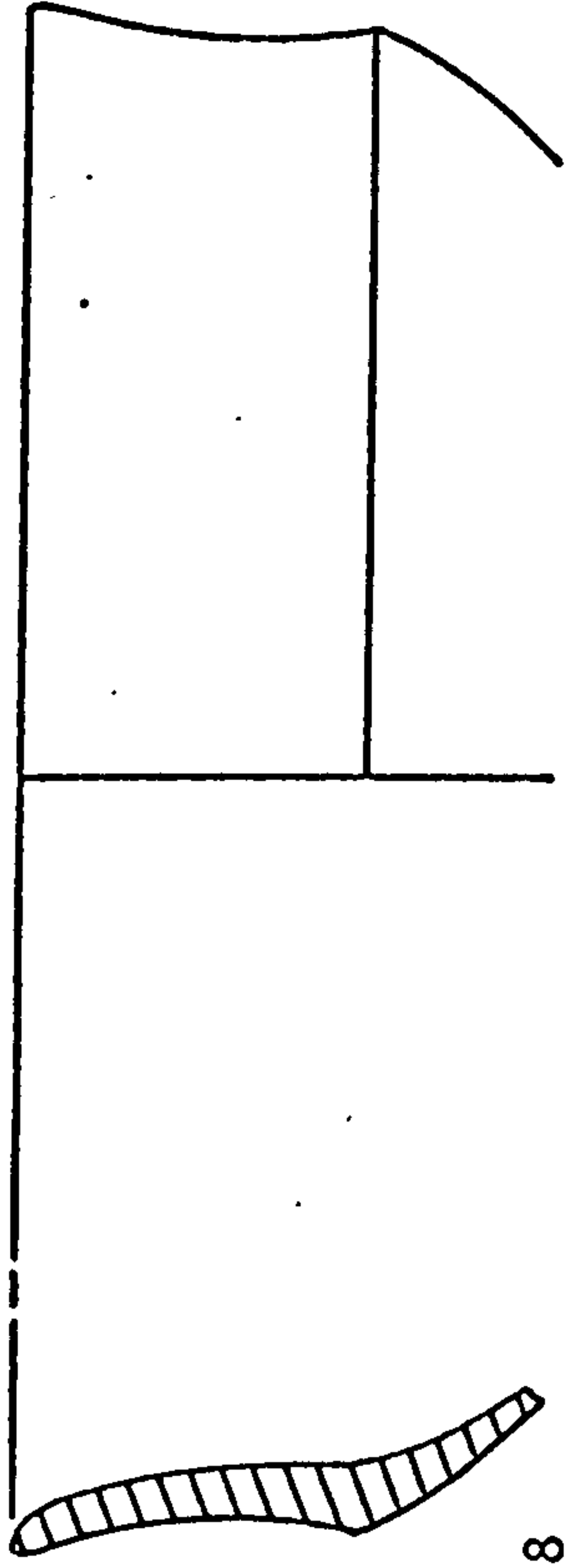

8308

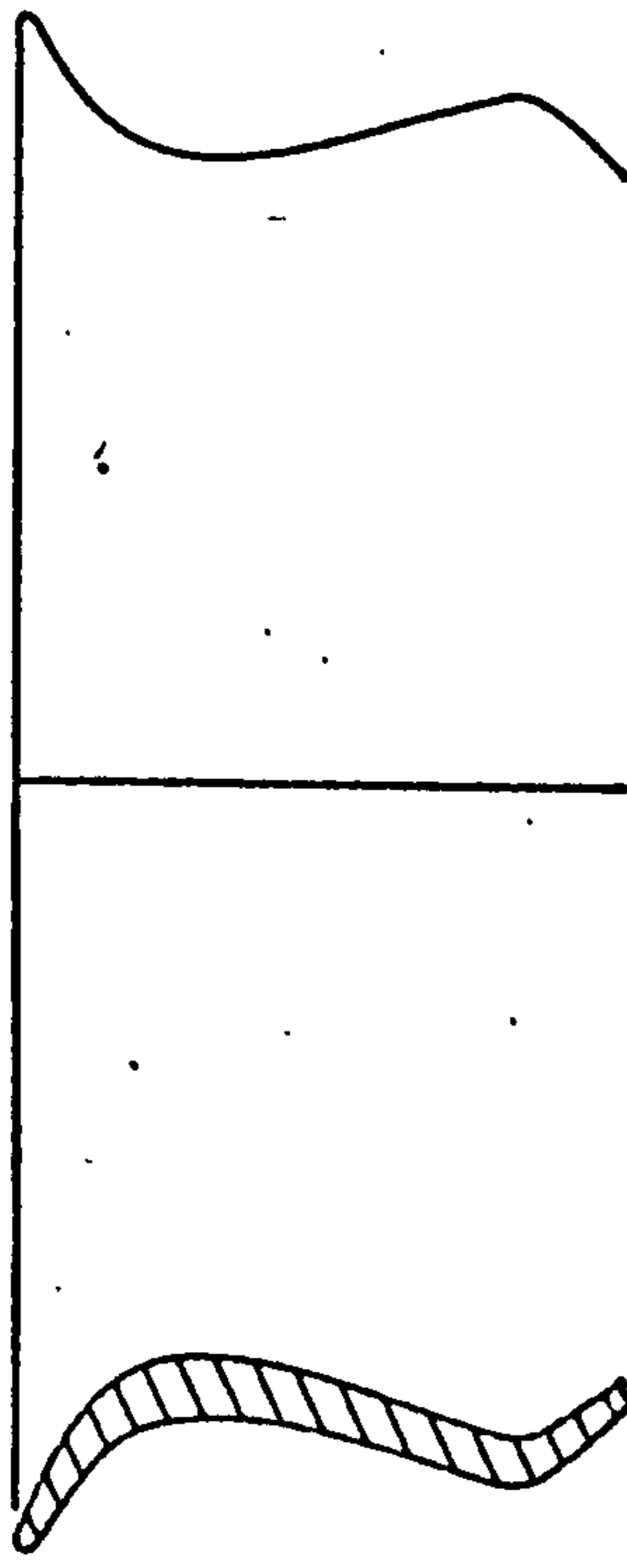

C 1

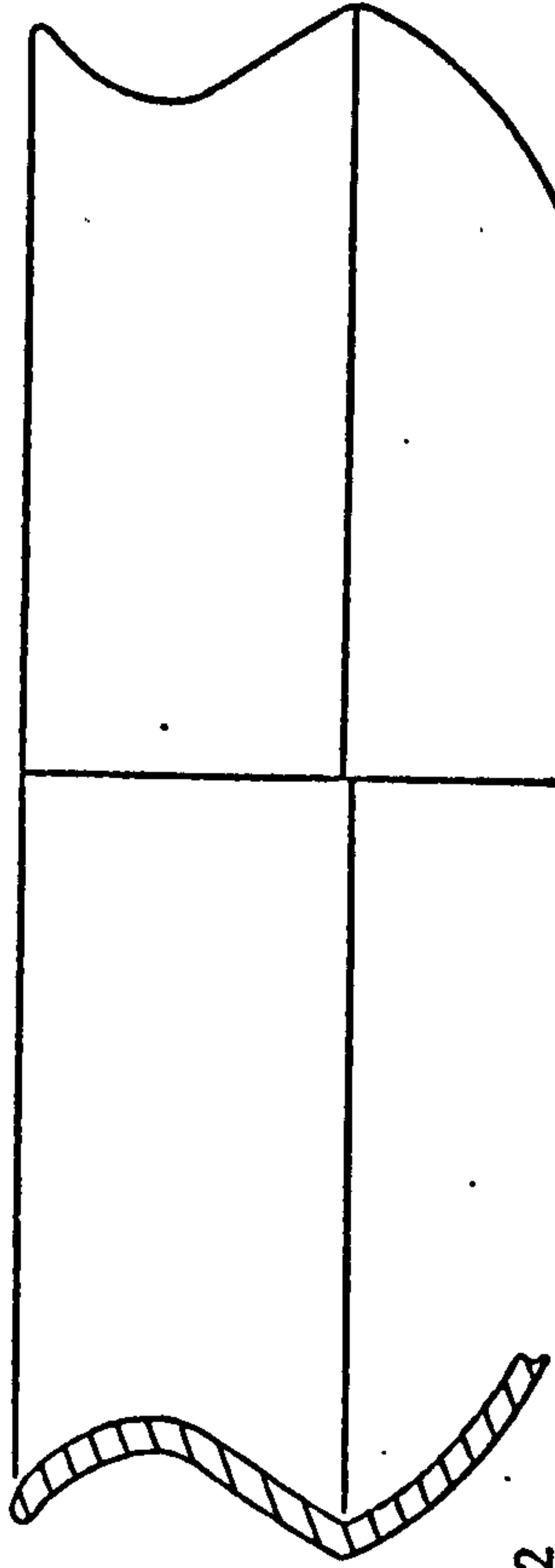

2432

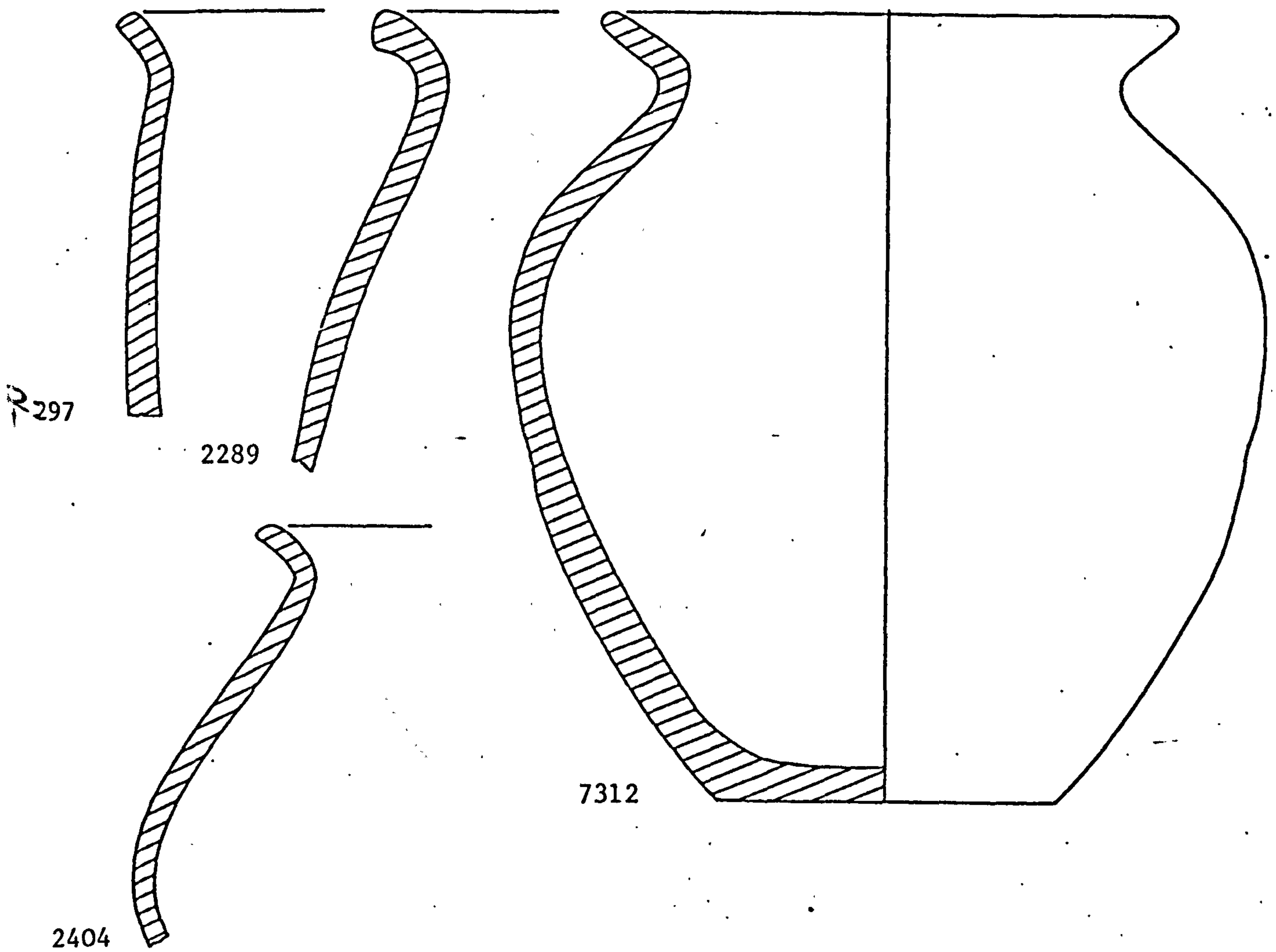
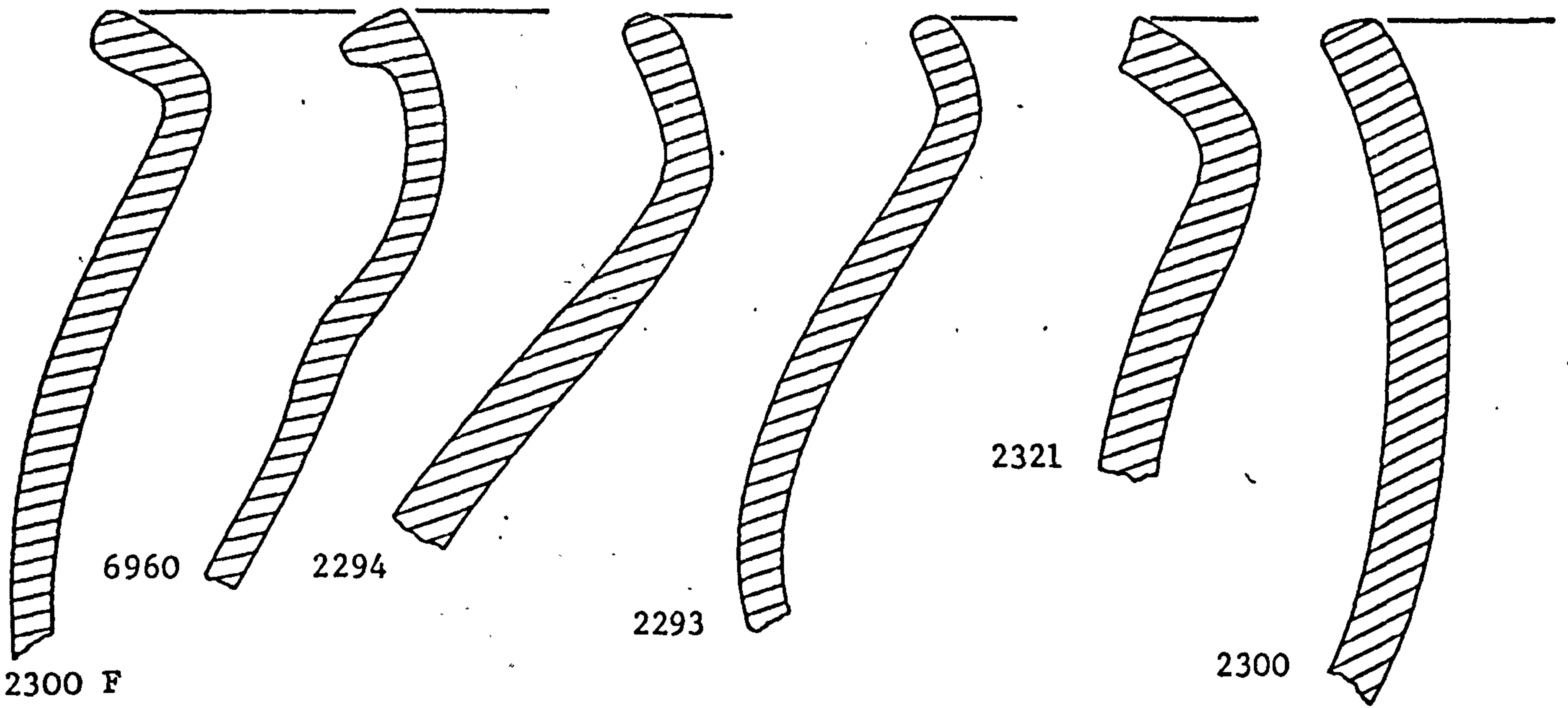

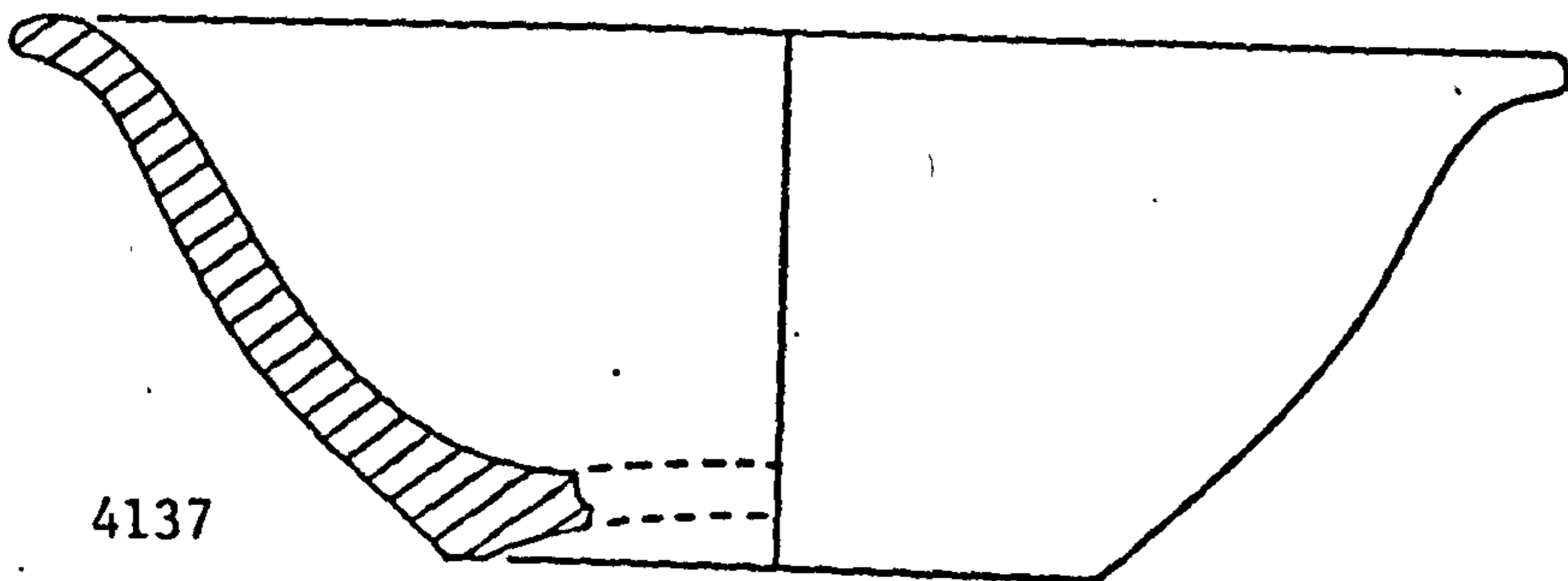
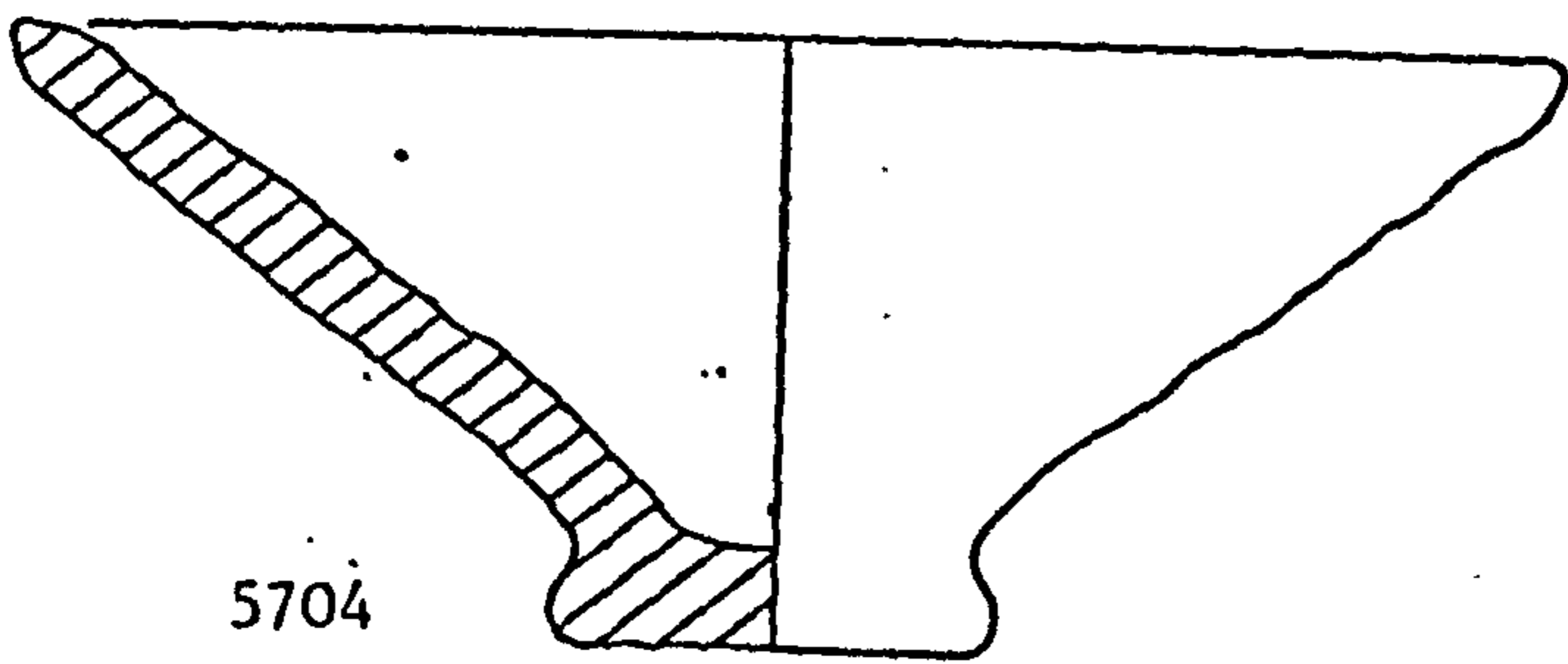
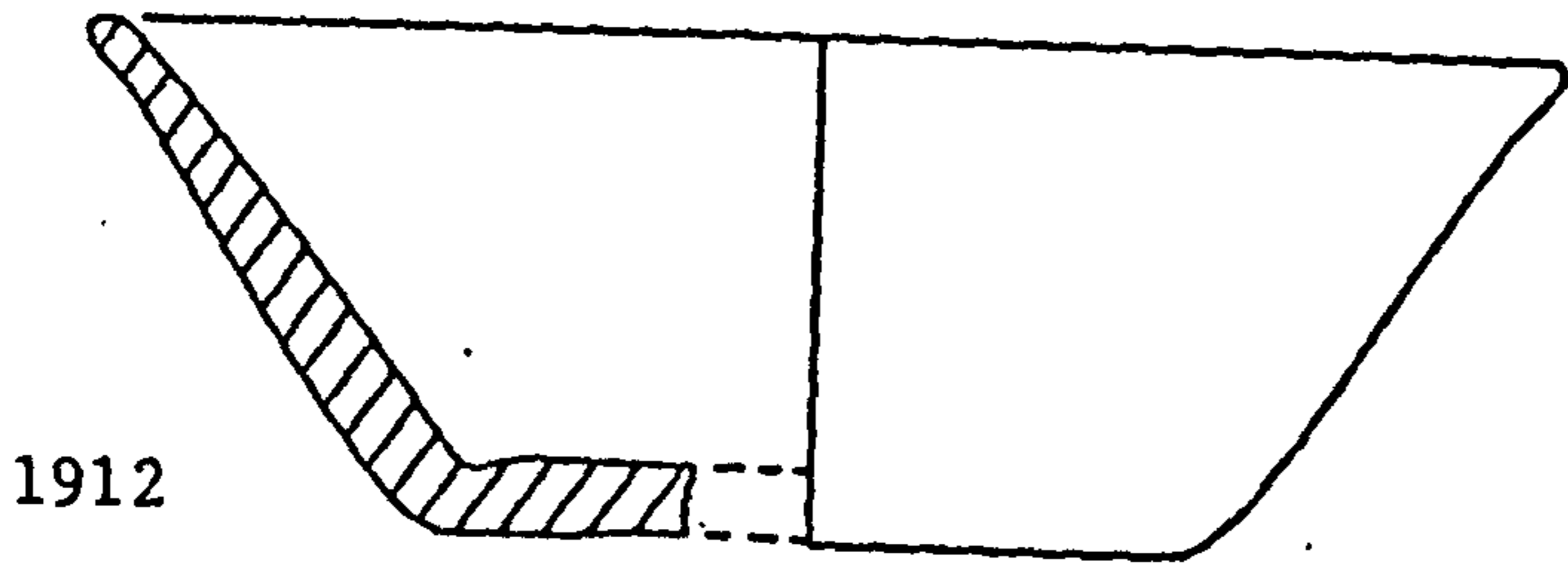
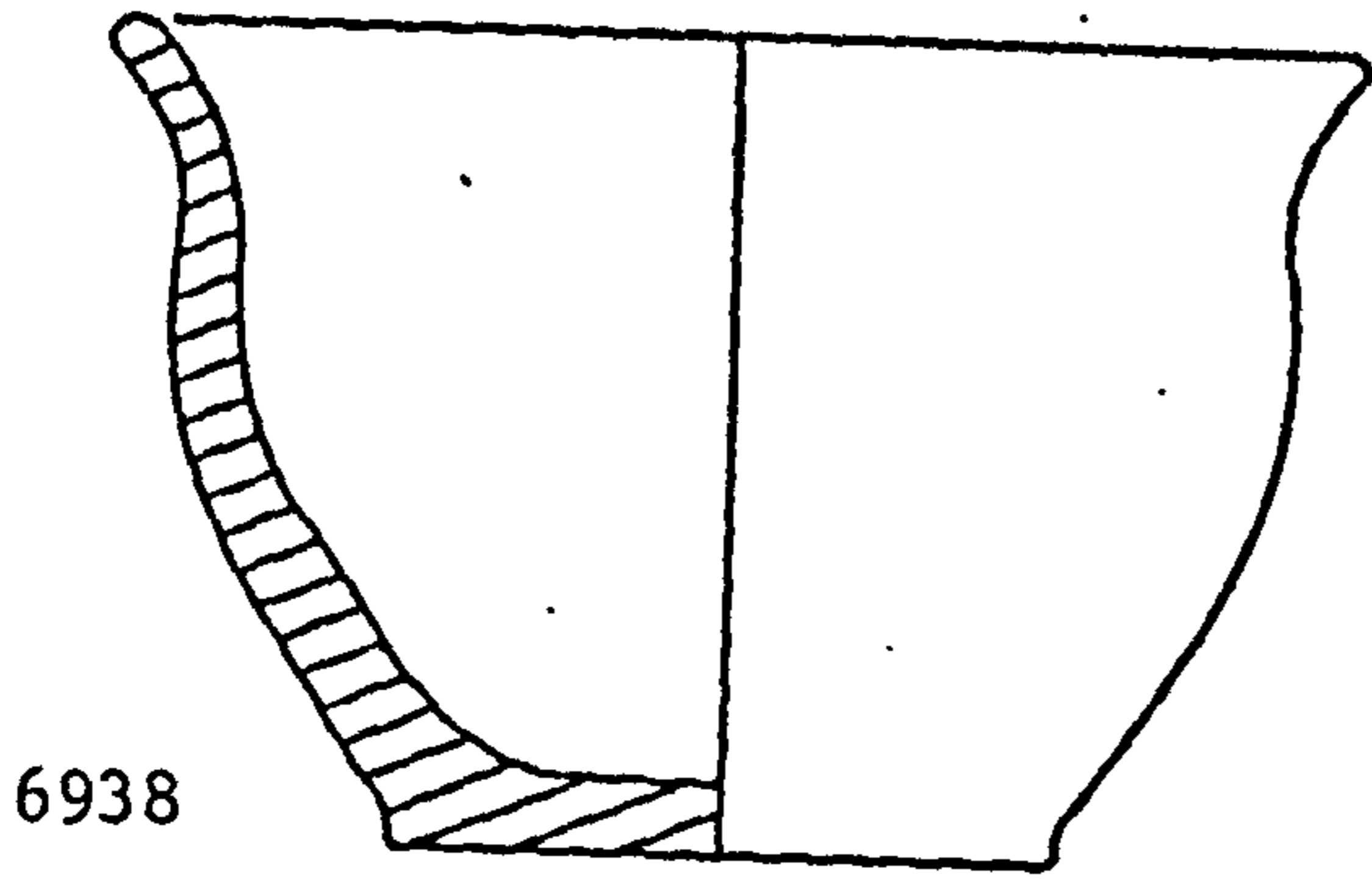

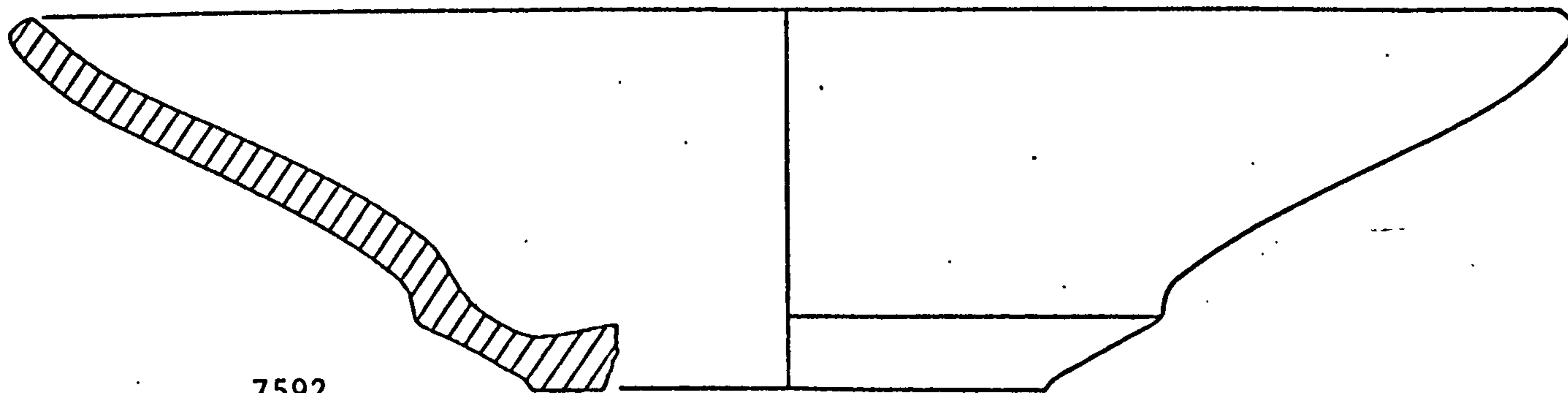
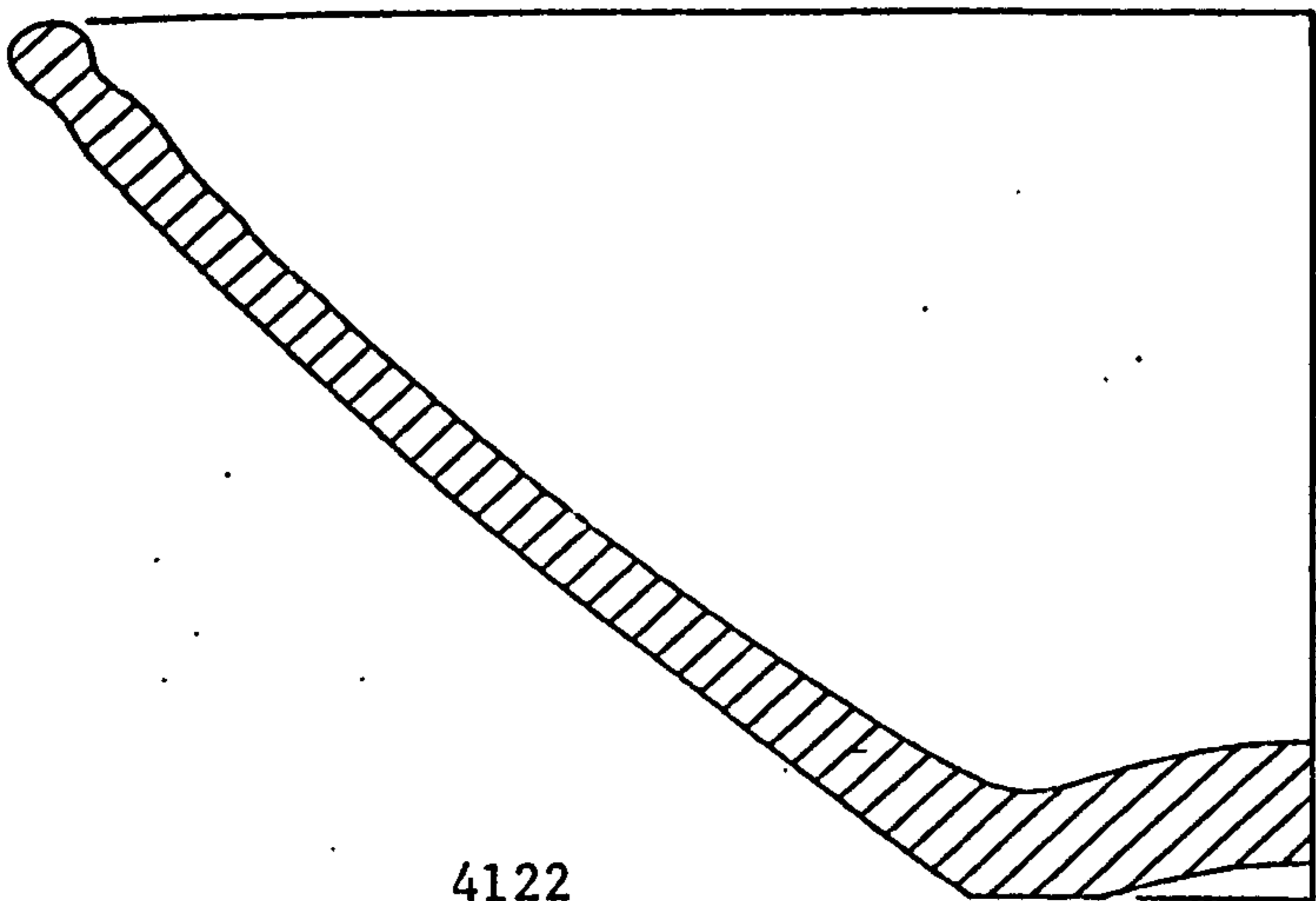
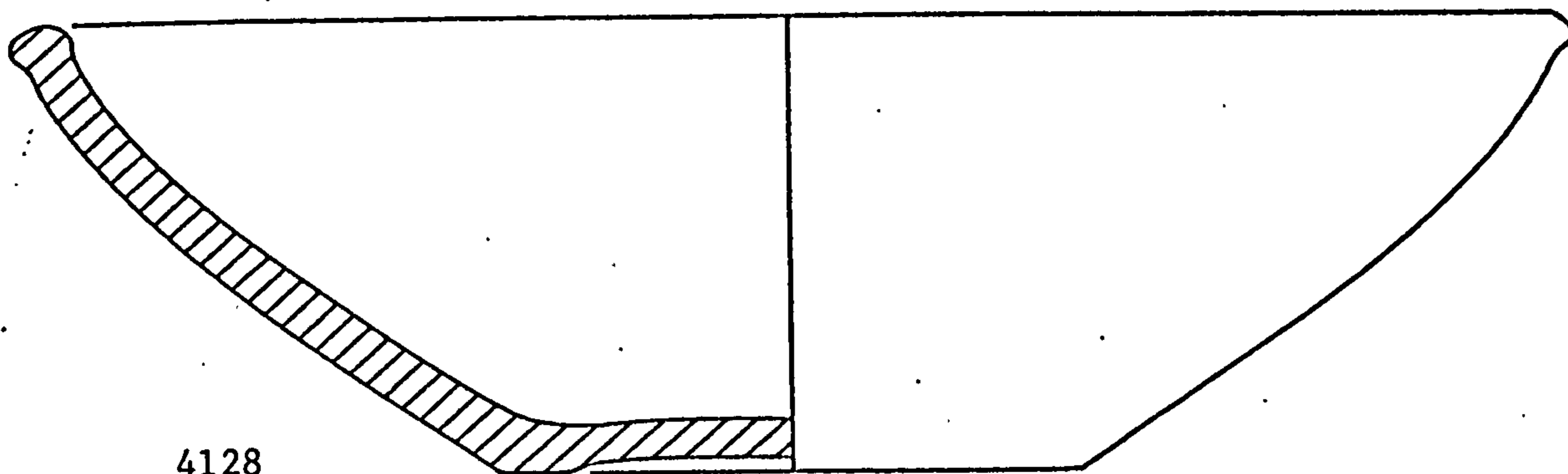
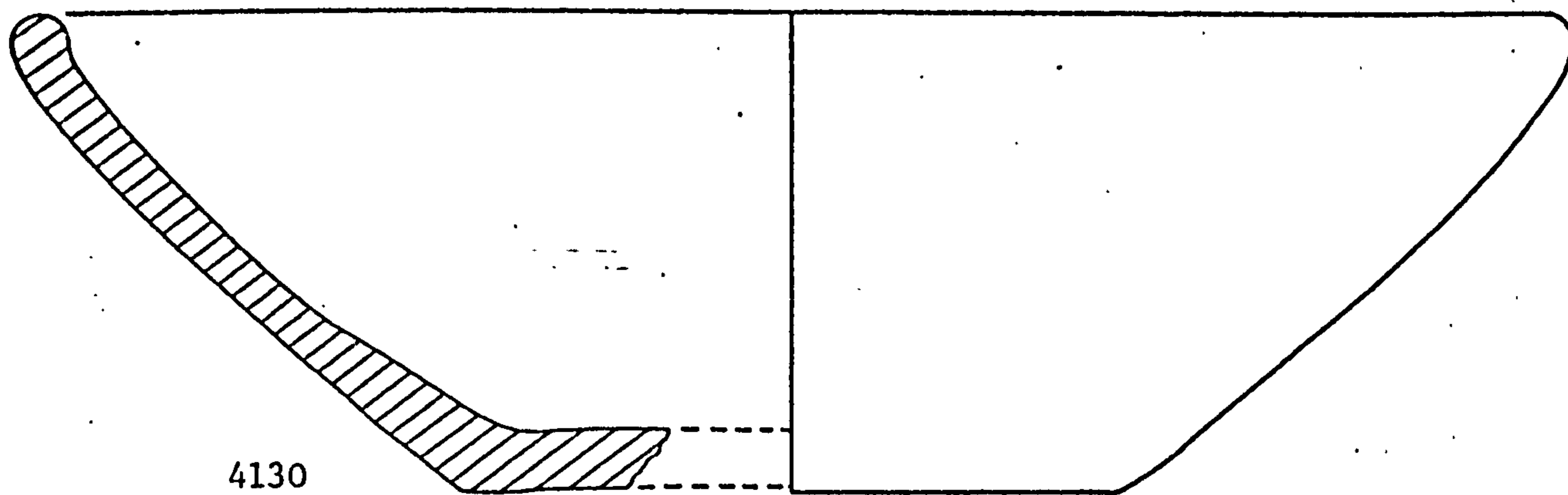

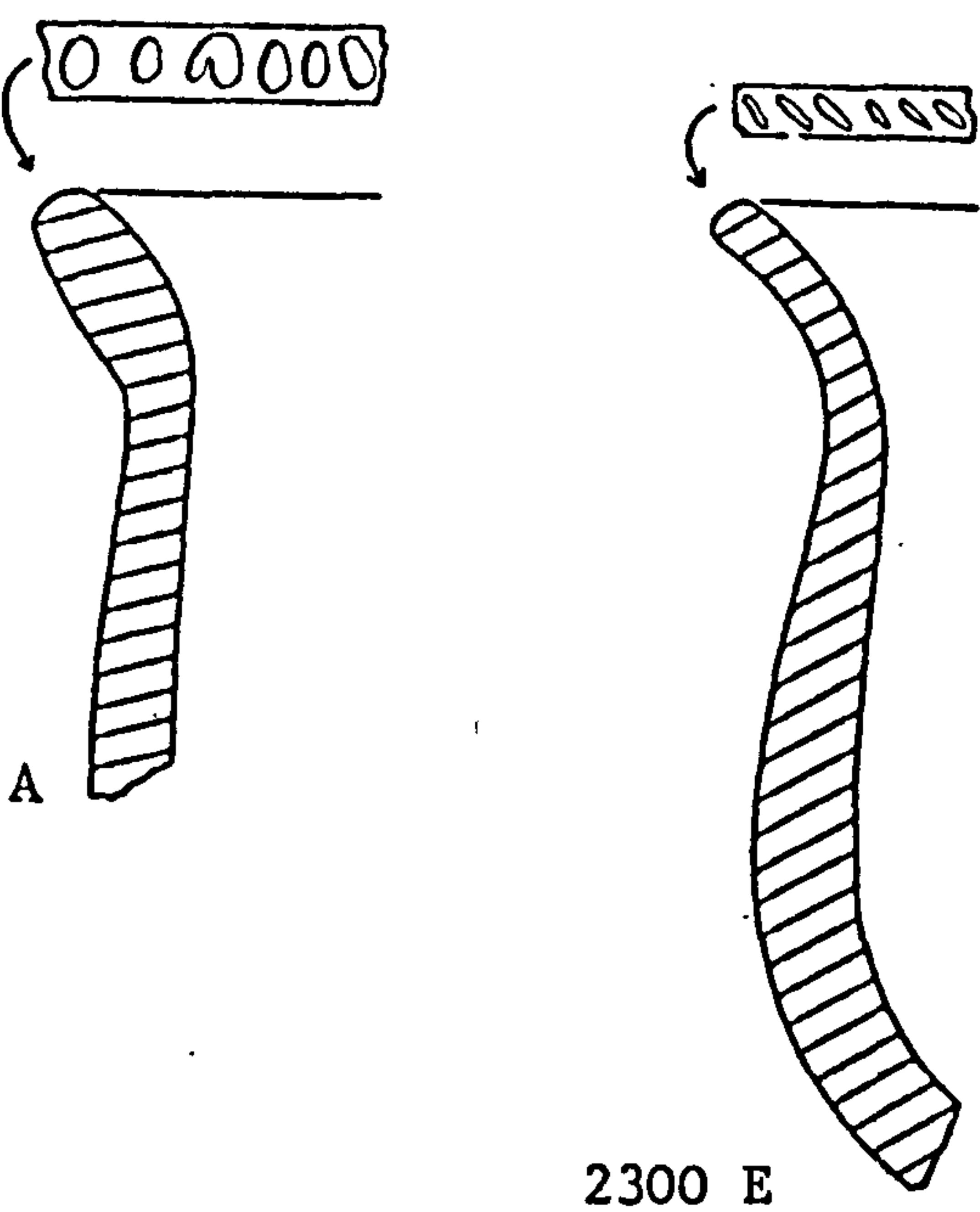
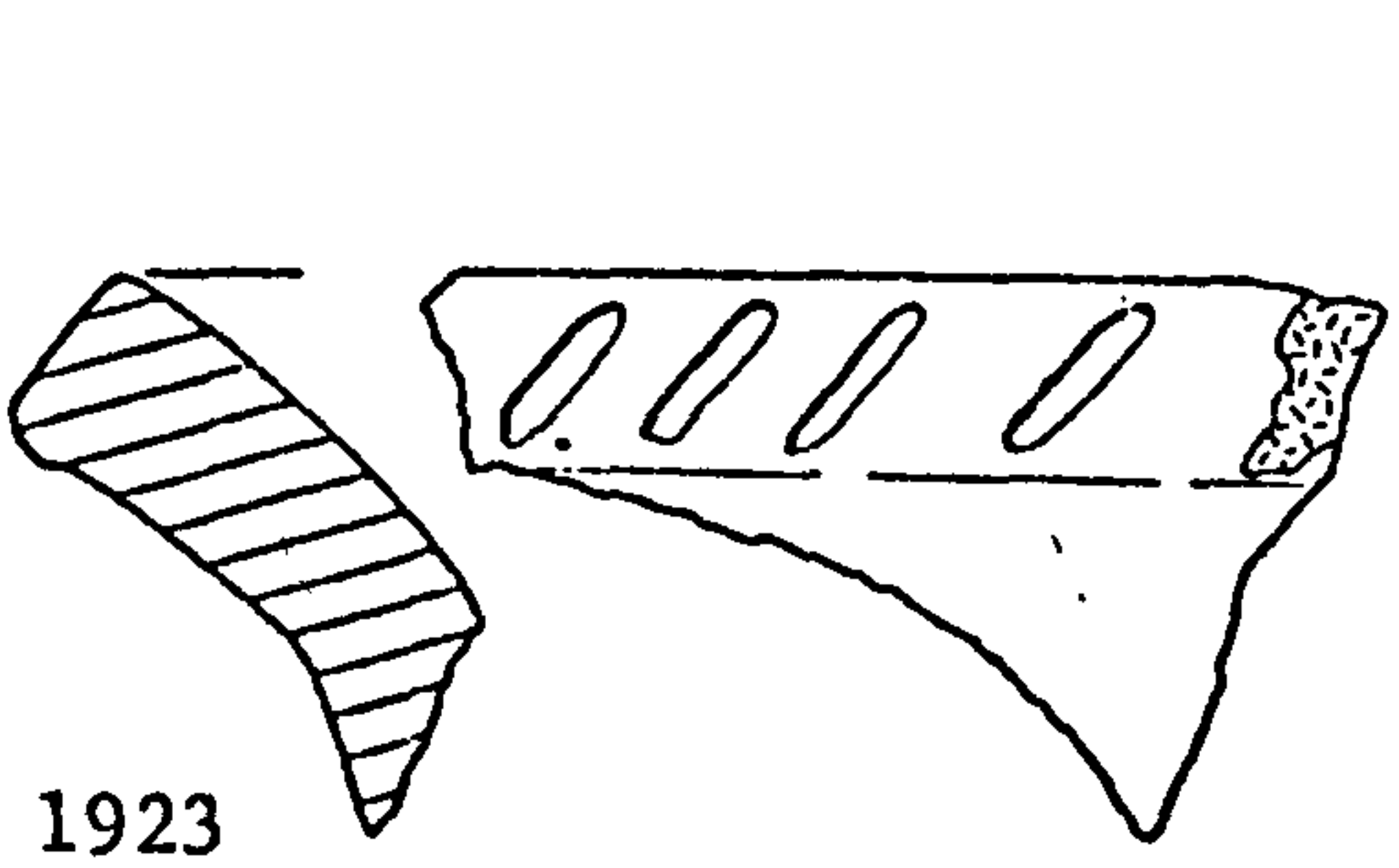
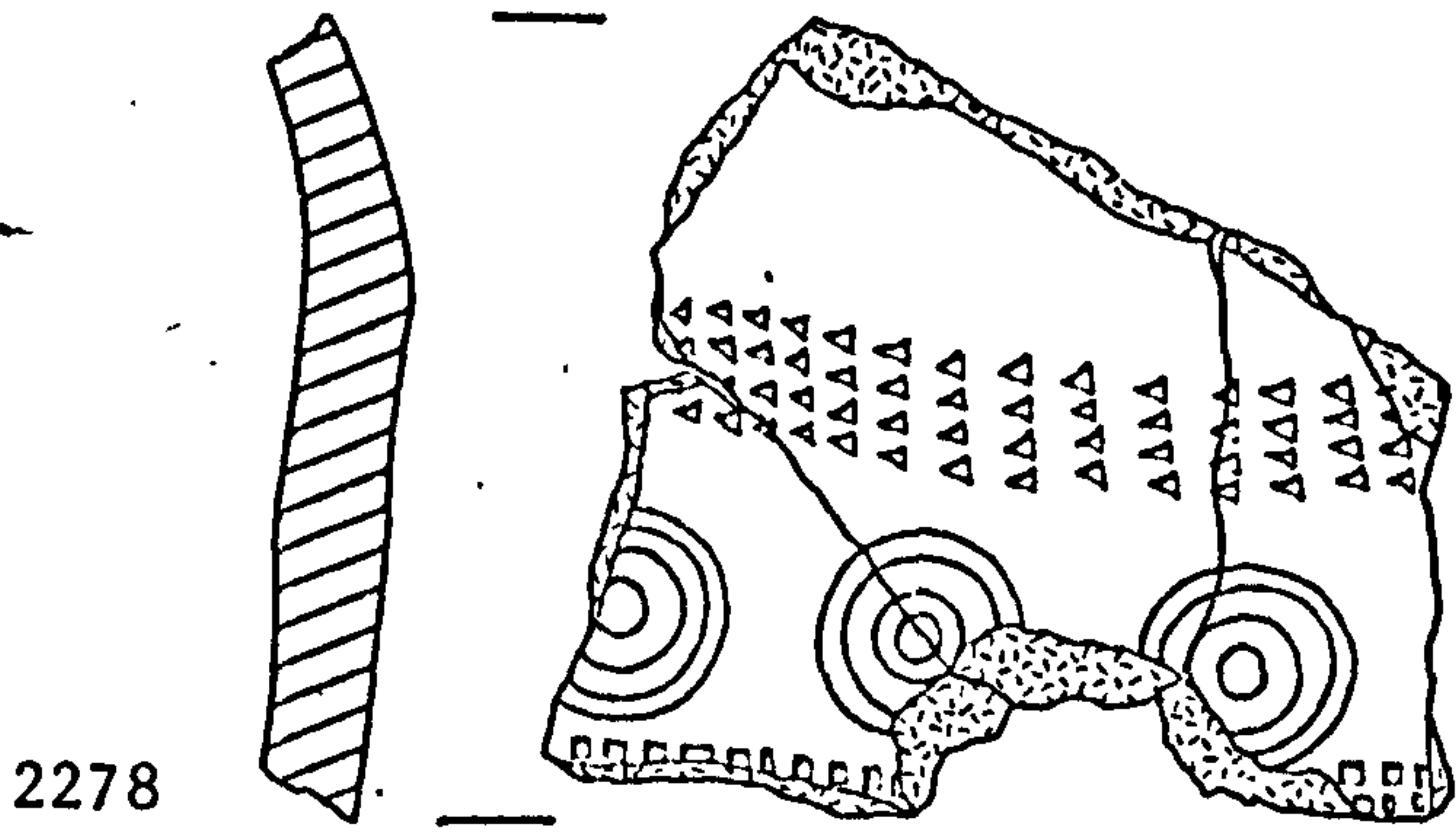
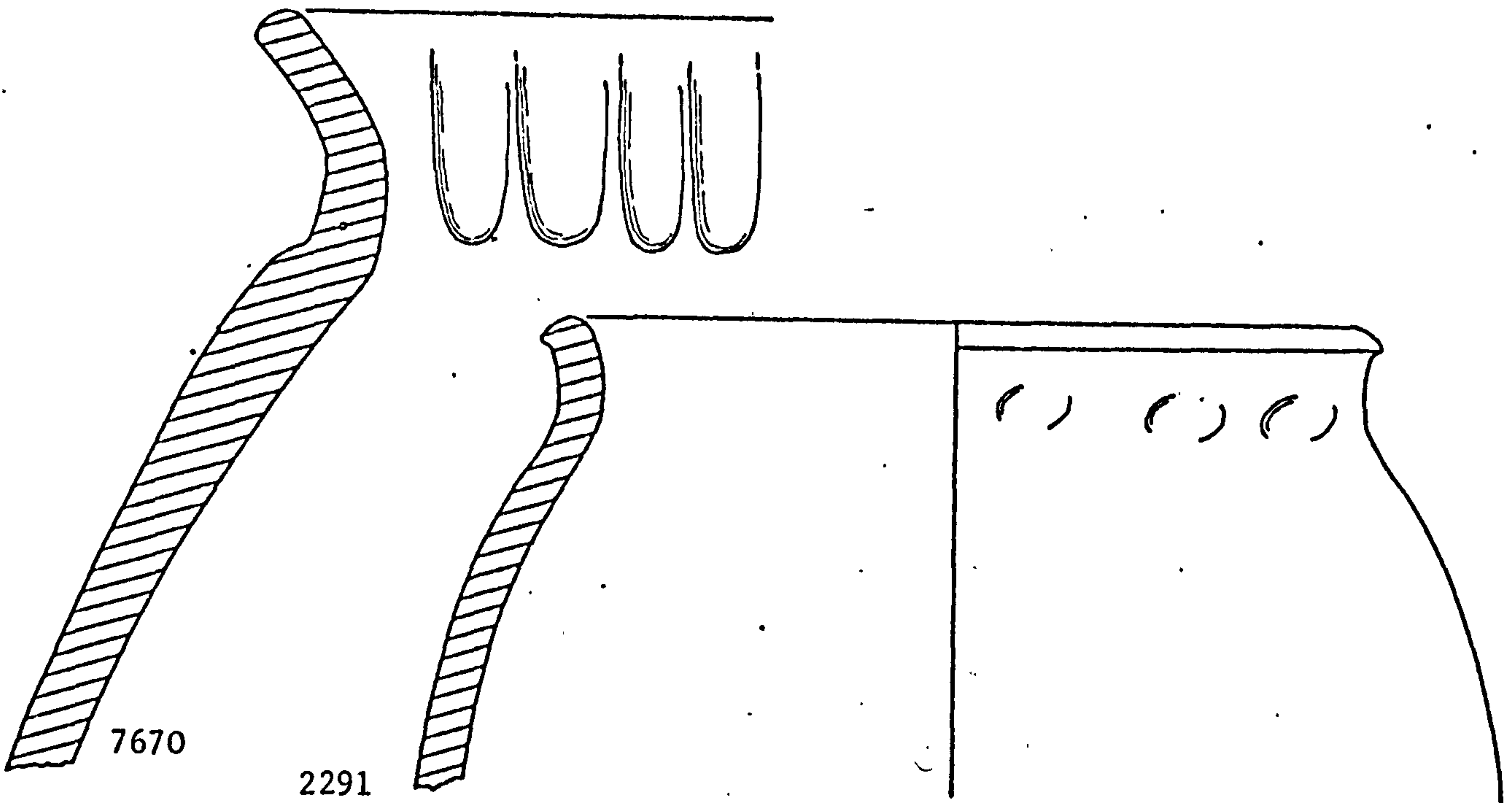

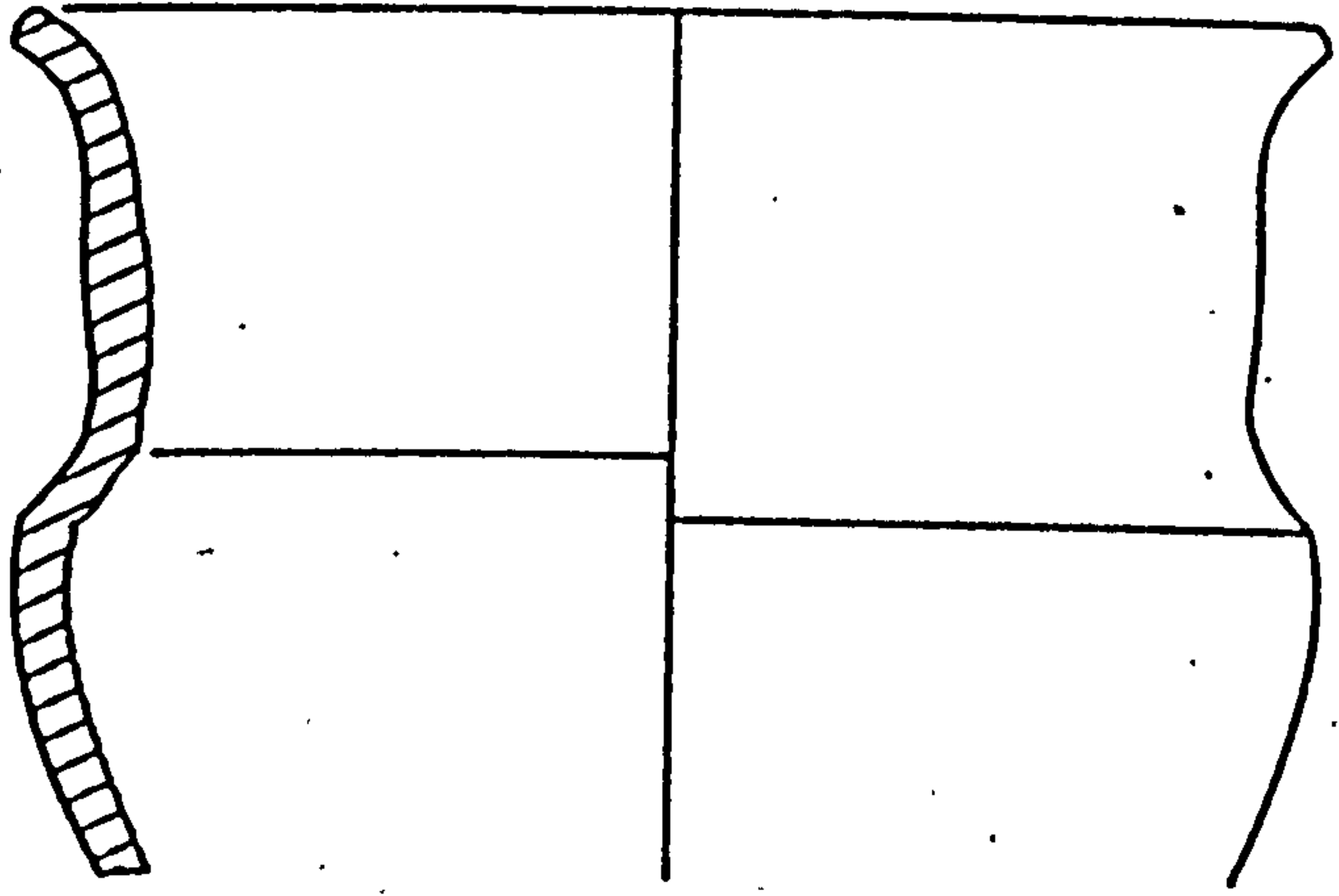

2379 D

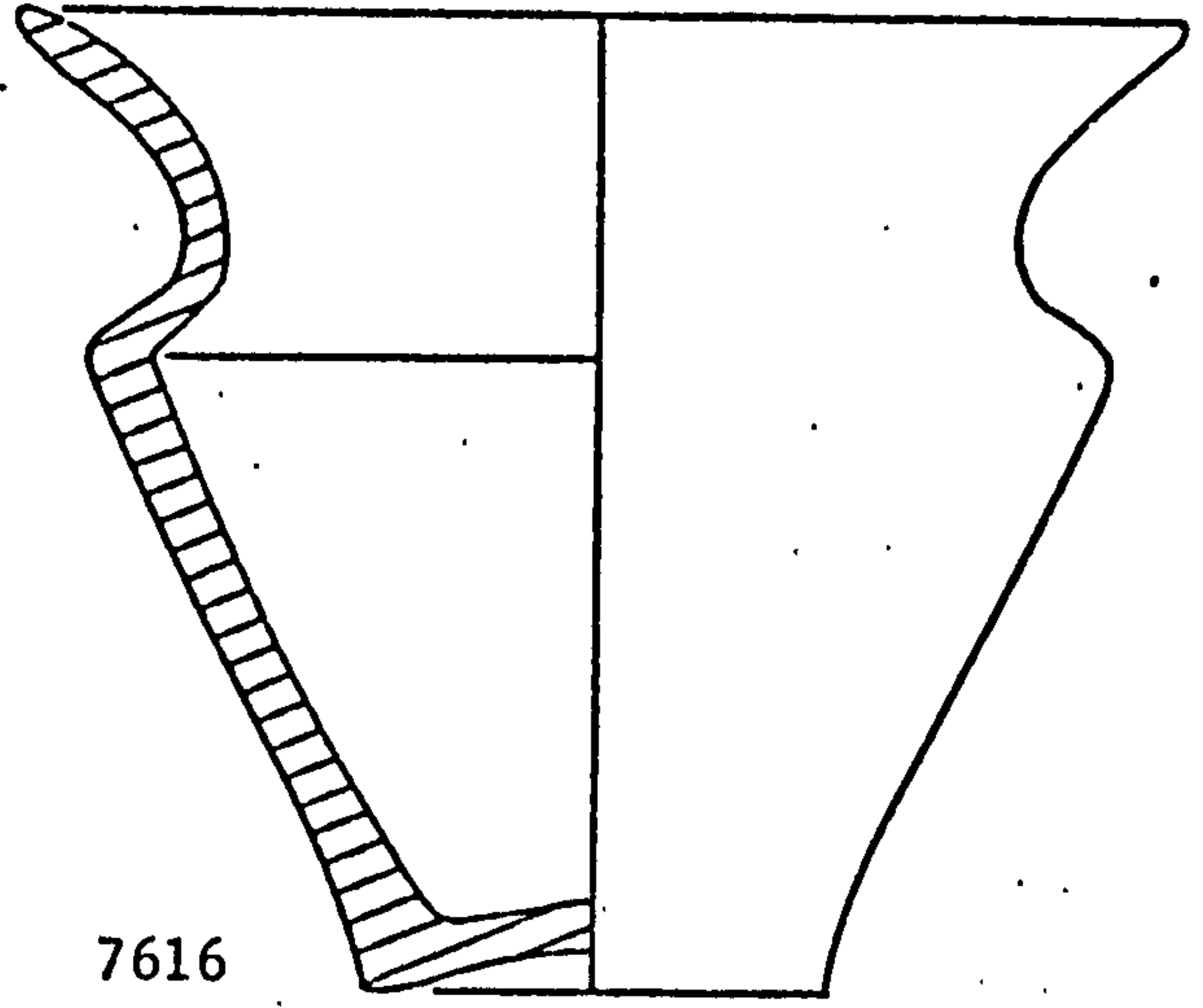

7616

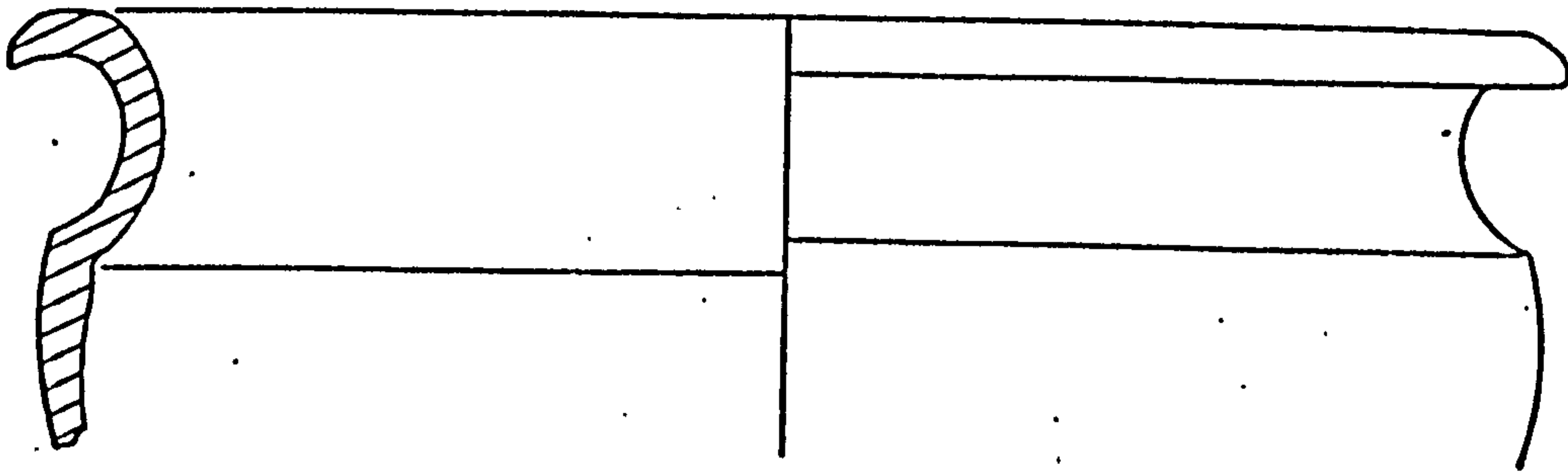

2338

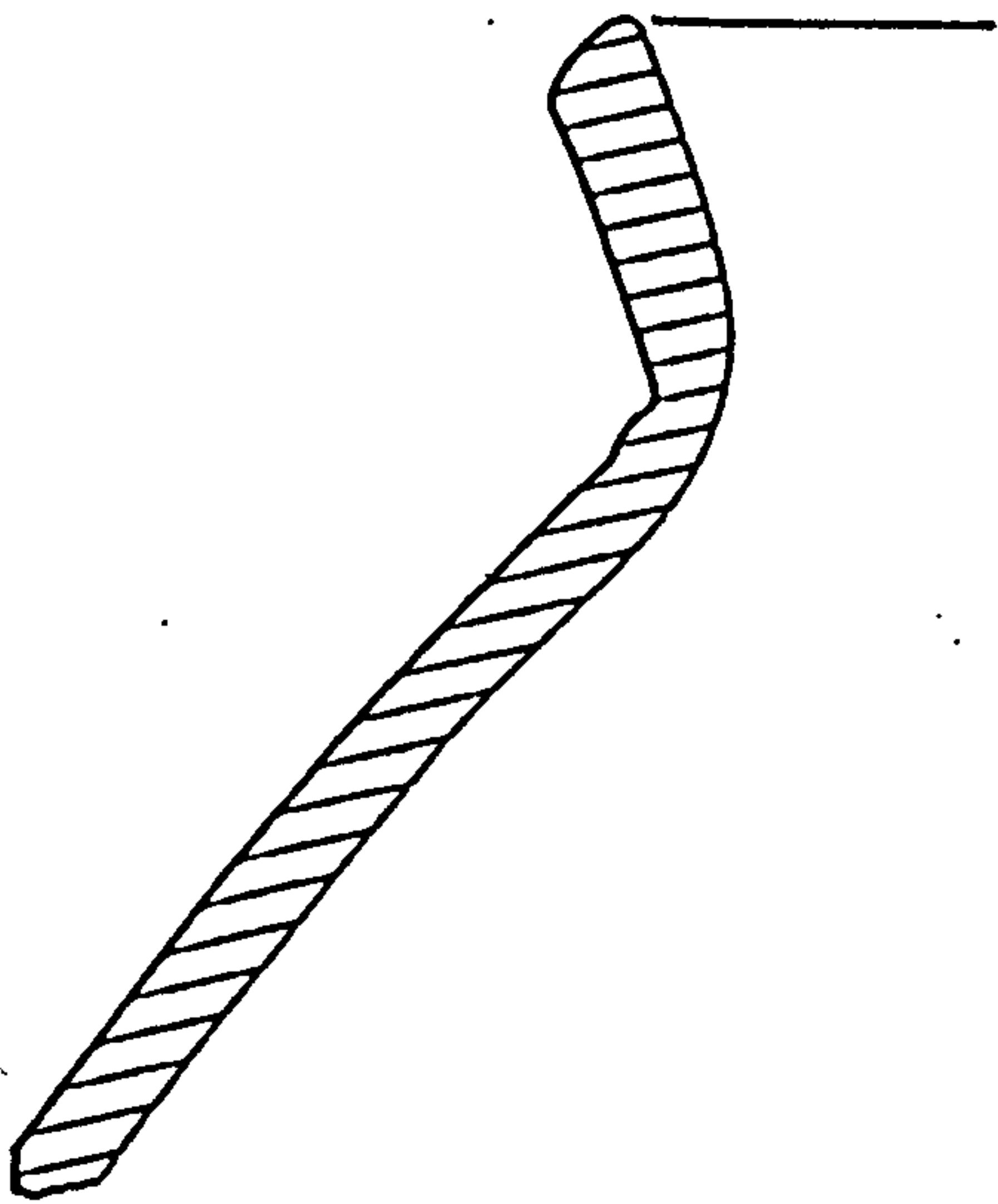

2415

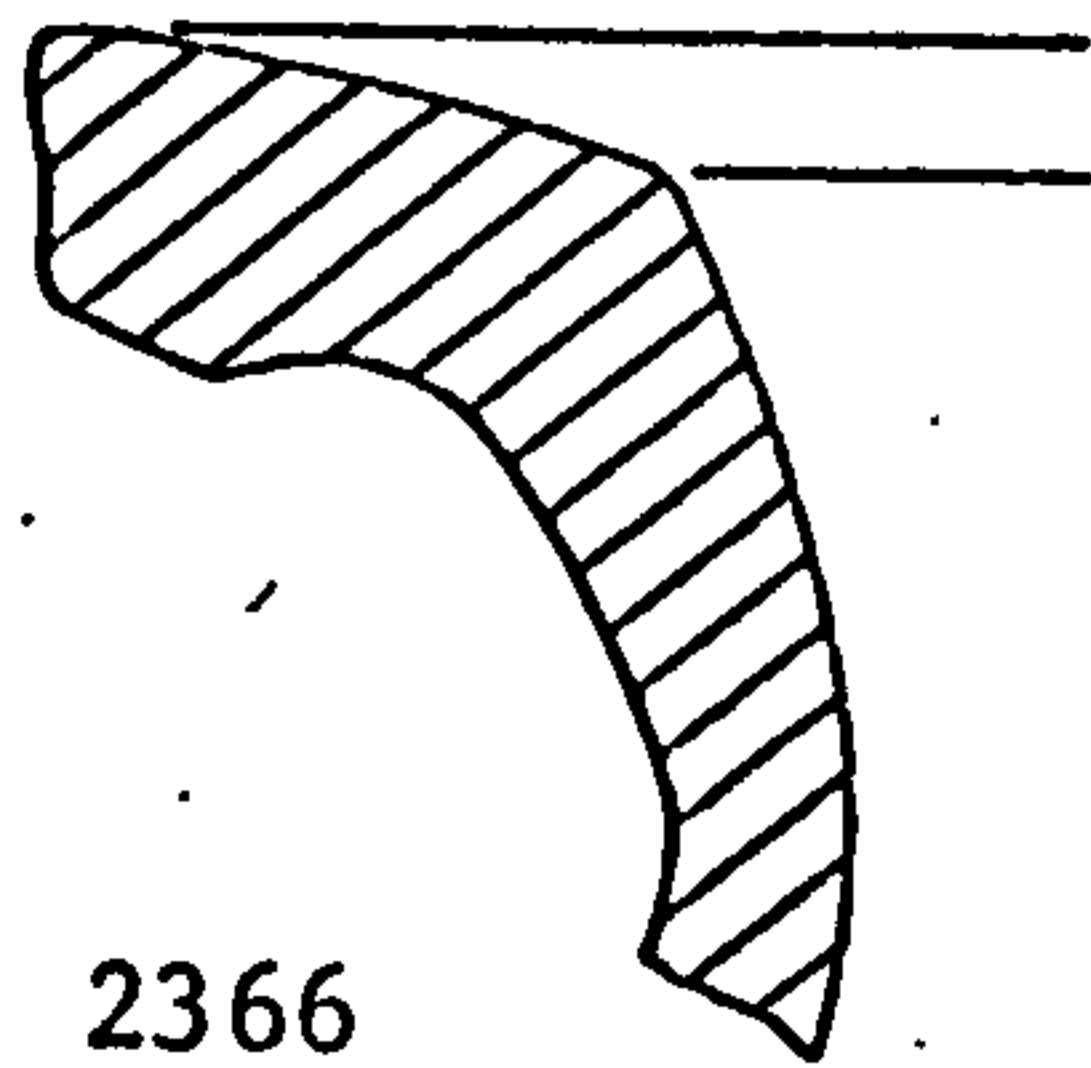

2366

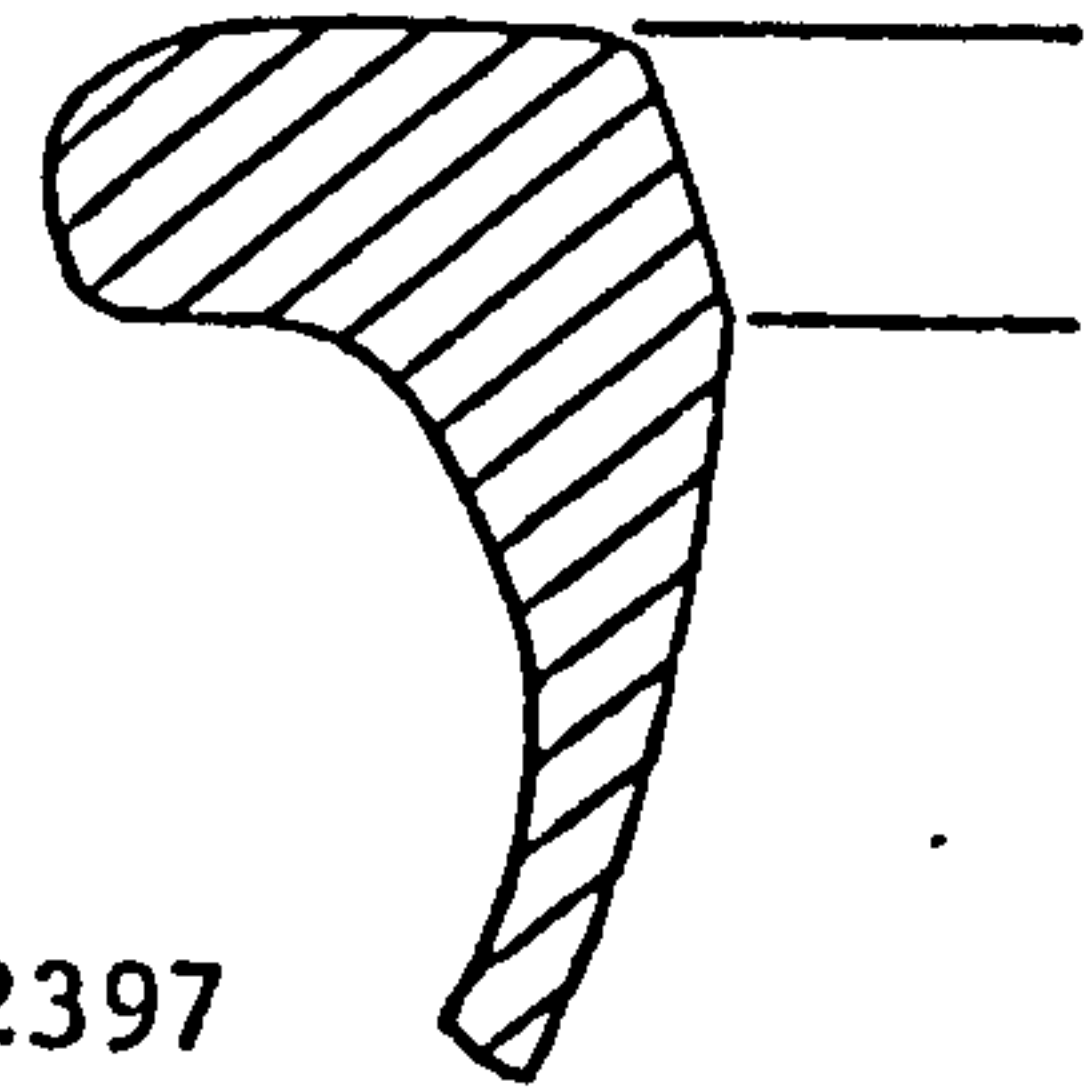

2397

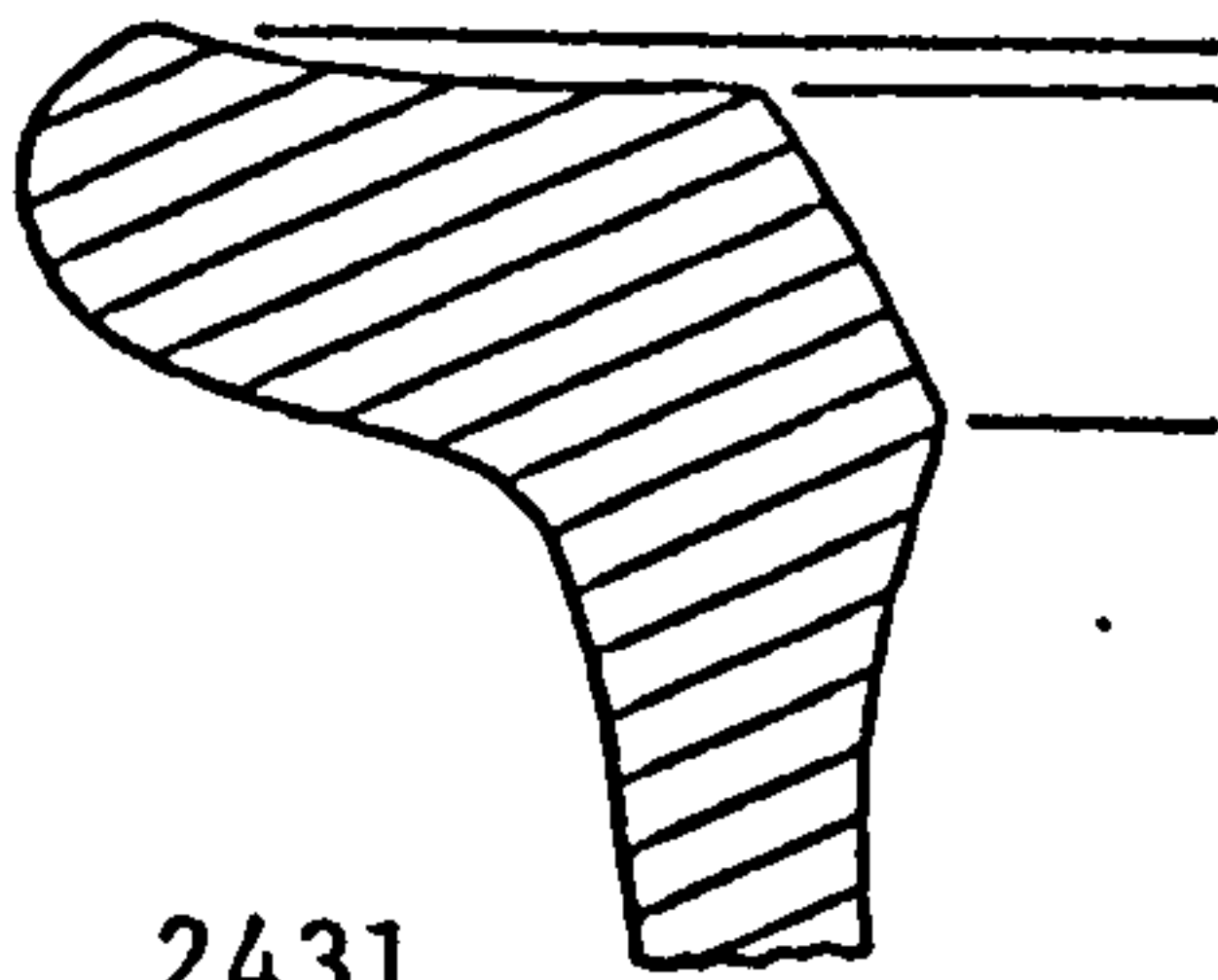

2431

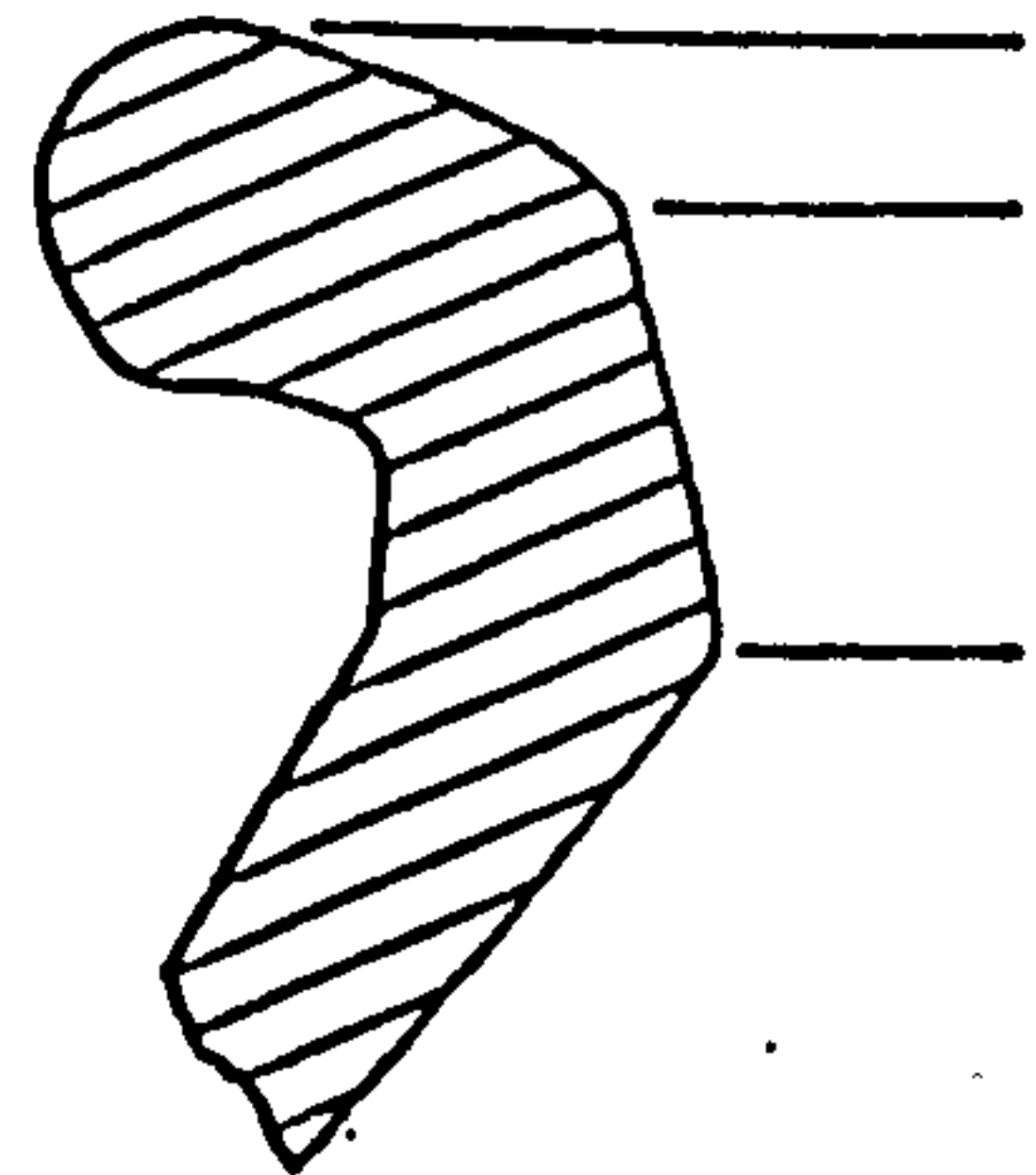

2430

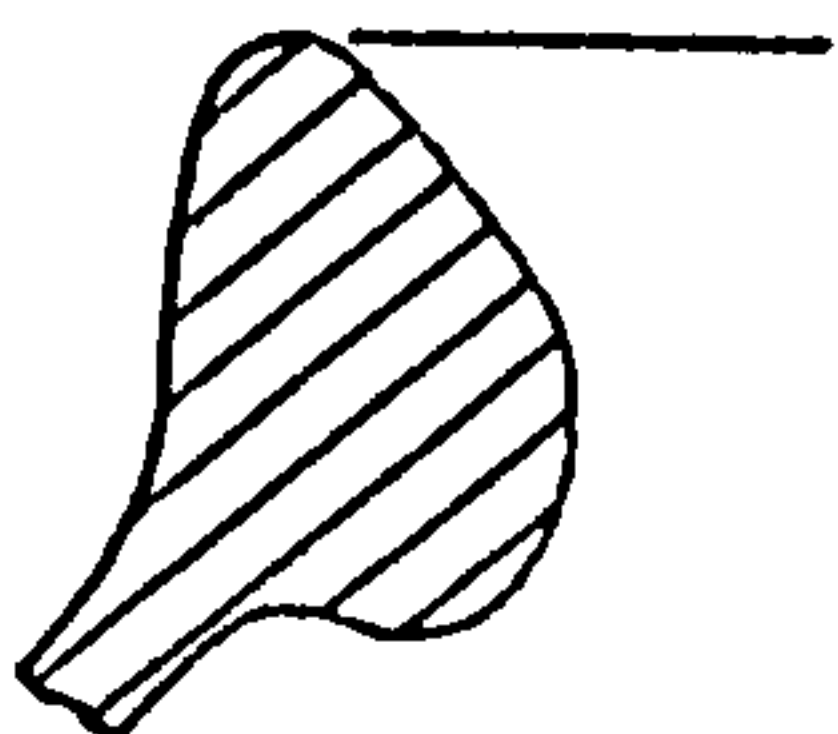

2463

APPENDIX 2POTTERY FROM IRON AGE BURIALS IN THE CEMETERY OF ALCÁ CER DO SAL
(BAIXO ALENTEJO, PORTUGAL)

Plate No.	Collection	Catalogue No.	Tomb No.	TYPE OF VESSEL description
				URNS OF VARIOUS TYPES: SHORT NECKED WITH HANDLES BETWEEN RIB AND SHOULDER
49	1	53	118	buff-brown fine ware, micaceous, fine filler, traces of orange brown paint on rim and body
50	1	51	11	brown, burnished, irregular shape, quartz filler, probably hand-made, base reconstructed
51	1	54	93	grey-brown, mostly encrusted 'AMPHORA'
52	1	52	'parte baixo'	orange-brown, small black filler, white encrustation, handles differ GLOBULAR VESSEL
53	1	64	38 or 62	dark brown-grey, smoothed surface, mica and other fine filler, worn and encrusted 'IBERIAN' DERIVED FORMS
54	1	76	16	orange micaceous, fine black filler particles
55	1	55	26	orange-buff micaceous, small quartz particles, some red paint c.7.5R 4/4 - 7.5YR 6/4
56	1	73	18	orange-buff micaceous, c.7.5YR 6/4, small filler particles, paint c.7.5R 5/6 on outside more faded: originally c.7.5YR 6/4 (Note: falcata, spearhead and soliferreum associated with it)
57	1	56	16(?)	brown-buff, slightly micaceous, c.7.5R 4/6 (or lighter) on c.7.5YR 6/4, characteristic zoning of wavy lines 'Iberian'

APPENDIX 2 continued

Plate No.	Collection	Catalogue No.	Tomb No.	TYPE OF VESSEL description
				PLATES: RED SLIP OR PAINTED, WHEEL-MADE
58	3	A 1	?	*
	2	46	?	yellow-brown micaceous, large quartz filler, red on interior only: 10R 4/4 on c.7.5YR 6/4
	2	4	27	orange-brown, grey core, small quartz particles
	2	47	?	orange-brown, mica and white filler, red paint on interior
	3	A 2	?	*
	2	5	27	orange, probably red on interior
	3	A 3	?	*
	2	30	?	orange-brown, red paint on interior only
	2	3	27	orange, red on interior, very worn
	2	31	?	c.26cm rim diameter, orange, slightly micaceous, paint on interior and exterior 10R 4/4
	2	32	?	c.25cm rim diameter, orange, slightly micaceous, red paint 7.5R 4/6 on inside
				SINGLE SPOUTED LAMPS
59	1	57	144	brown-red, slightly micaceous, black grit, wheel made, possibly with slip - now encrusted
	1	59	131	buff-brown, small black filler particles, grey in spout region
	1	58	22	orange-brown, micaceous, encrusted
	3	A 4	?	*
60	2	22	?	grey with orange-buff patches, ?hand-made 'AMPULLA'
	1	60	72	orange-brown, very encrusted, scars of handle
				SINGLE-HANDLED VESSELS
	1	66	101	wheel-made orange-brown micaceous, encrusted
	1	69	58	hand-made, black (burnt) very irregular, large filler

APPENDIX 2 continued

Plate No.	Collection	Catalogue No.	Tomb No.	TYPE OF VESSEL description
(SINGLE-HANDLED VESSELS)				
61	1	68	54	burnished brown-yellow surface, where not encrusted, micaceous, small filler
62	1	74	?15 ?55	orange-brown wheel-made, large quartz particles
NARROW MOUTHED VESSELS				
61	1	63	?54c	very fine thin, wheel-made, buff-yellow, micaceous, encrusted in parts
	1	62	?	buff-grey irregular shape, micaceous with small filler
	1	A 5	23	brown micaceous, small filler, mostly encrusted
62	1	75	55	orange micaceous, partly restored, encrusted
	1	61	15	buff-grey, wheel-made, small white filler, very encrusted
SMALL CONTAINER (URN) WITH LID.				
	1	A 6	18	orange-brown, wheel-made, quartz and black filler, surface mostly encrusted

* These vessels were recorded by Dr. H. Schubart in the M.E.B.
I thank him for the drawings.

Collections

- 1 Institute of Classical Studies, Coimbra University
- 2 Museu de Alcácer do Sal
- 3 Museu Etnologico de Belem, Lisbon

Colours: 'Munsell Soil Color Chart'

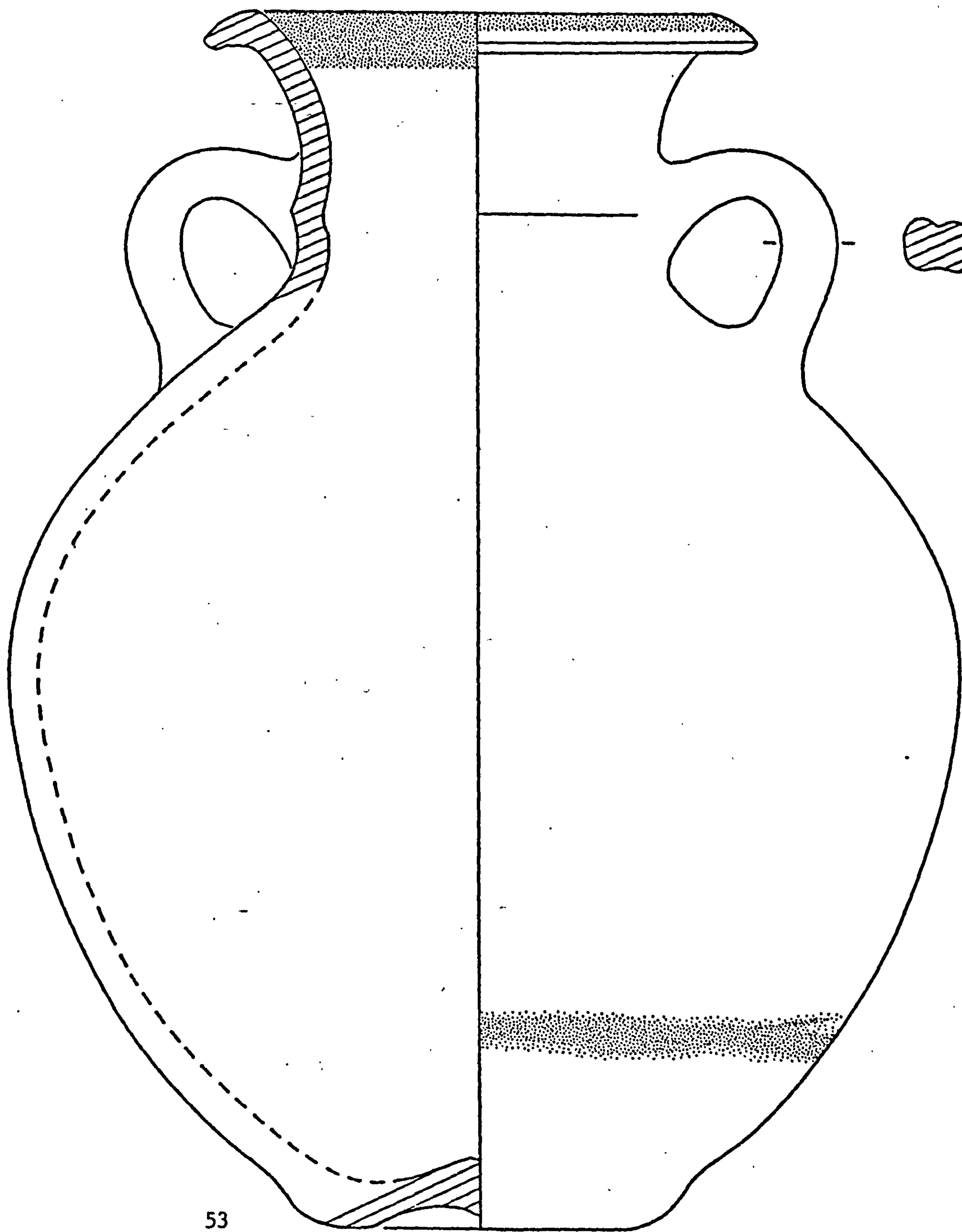

53

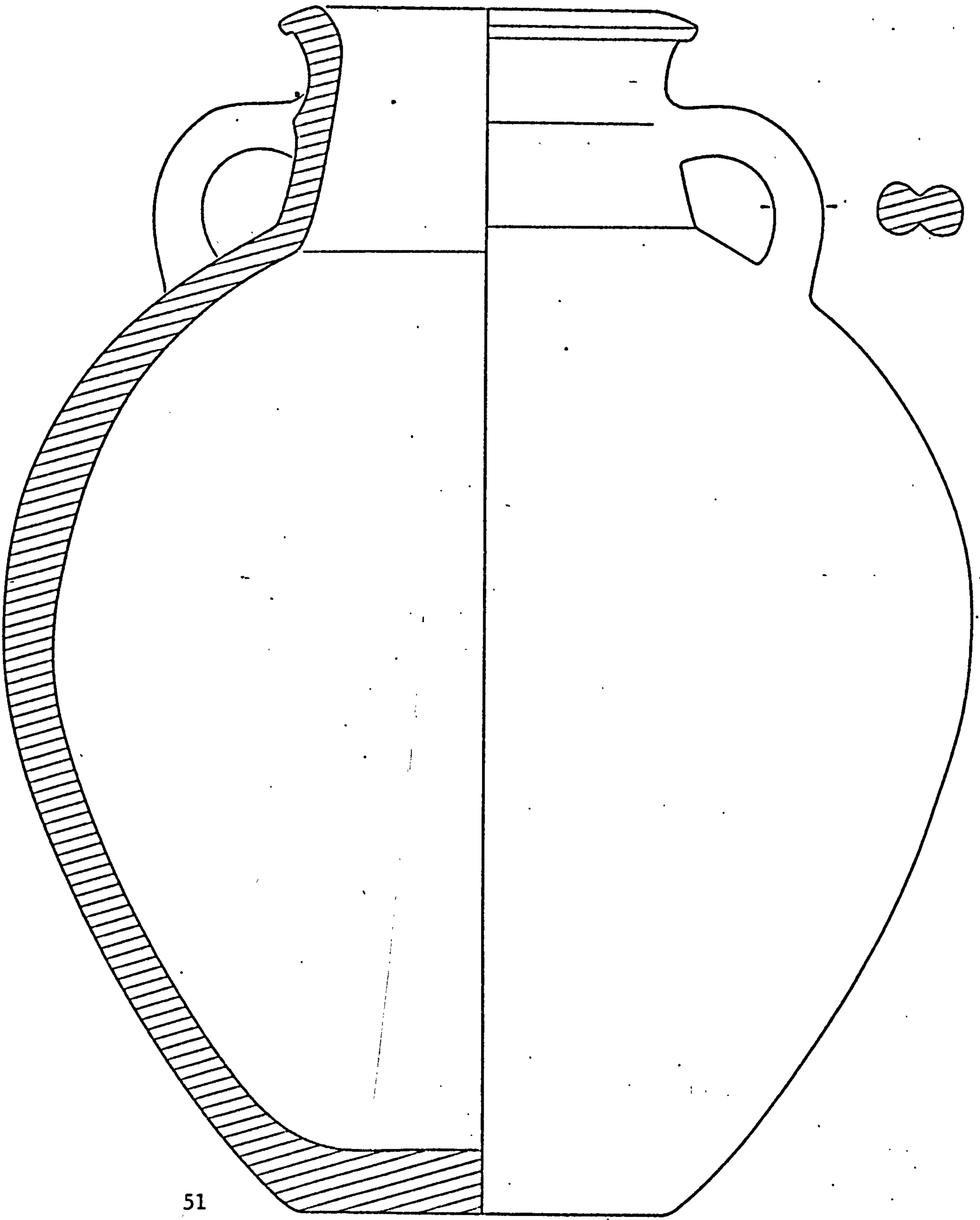

51

Plate 50: ALCÁCER DO SAL

0 10 cm

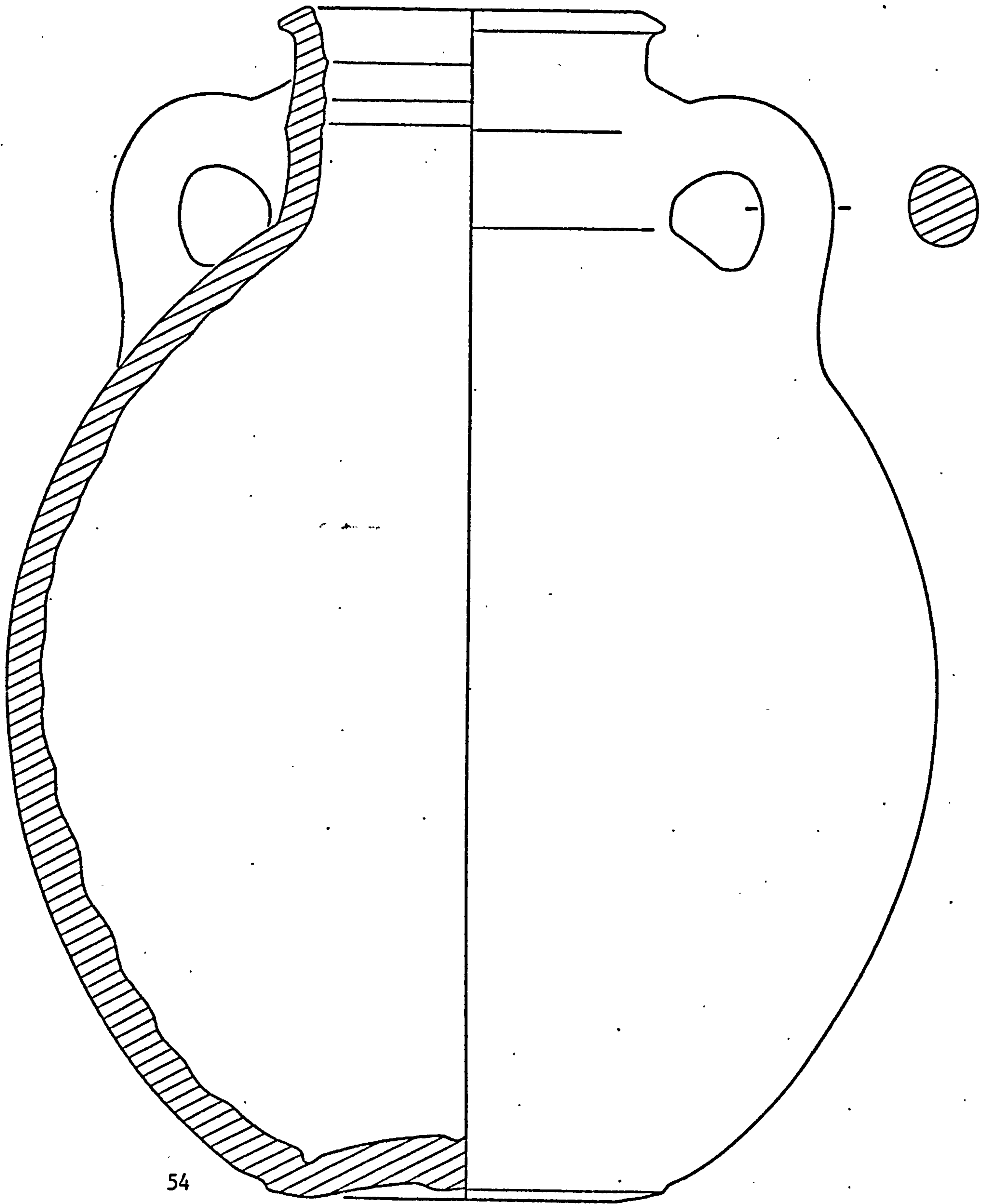

54

Plate 51: ALCÁCER DO SAL

0 10 cm

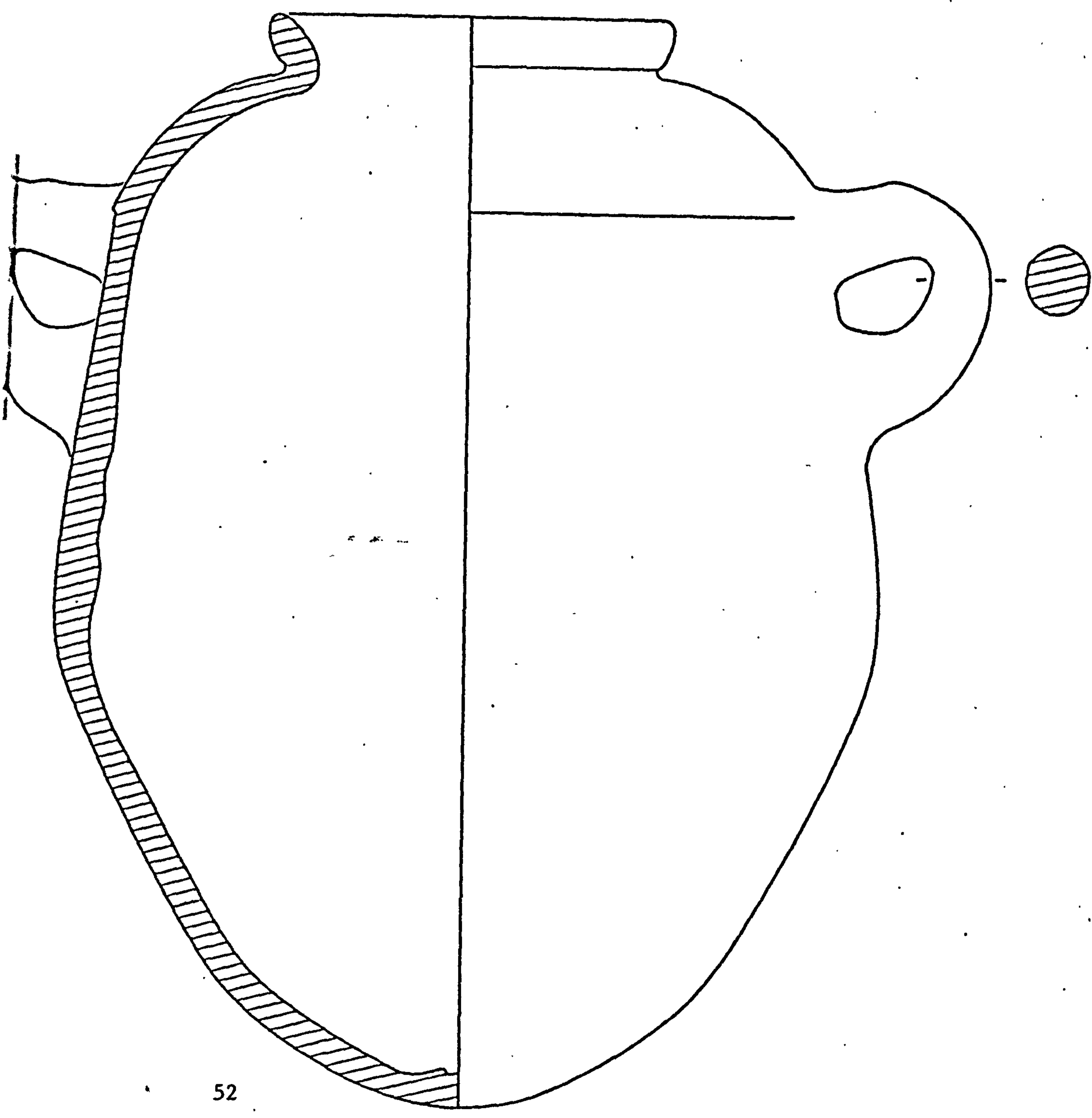

52

Plate 52: ALCACER DO SAL

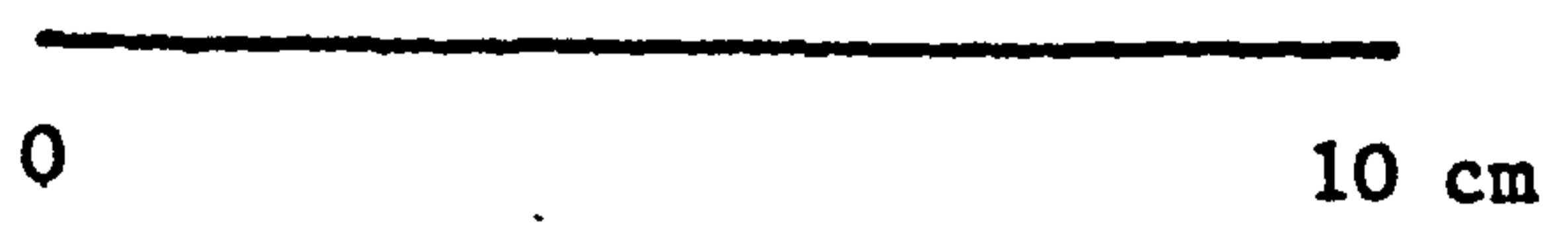

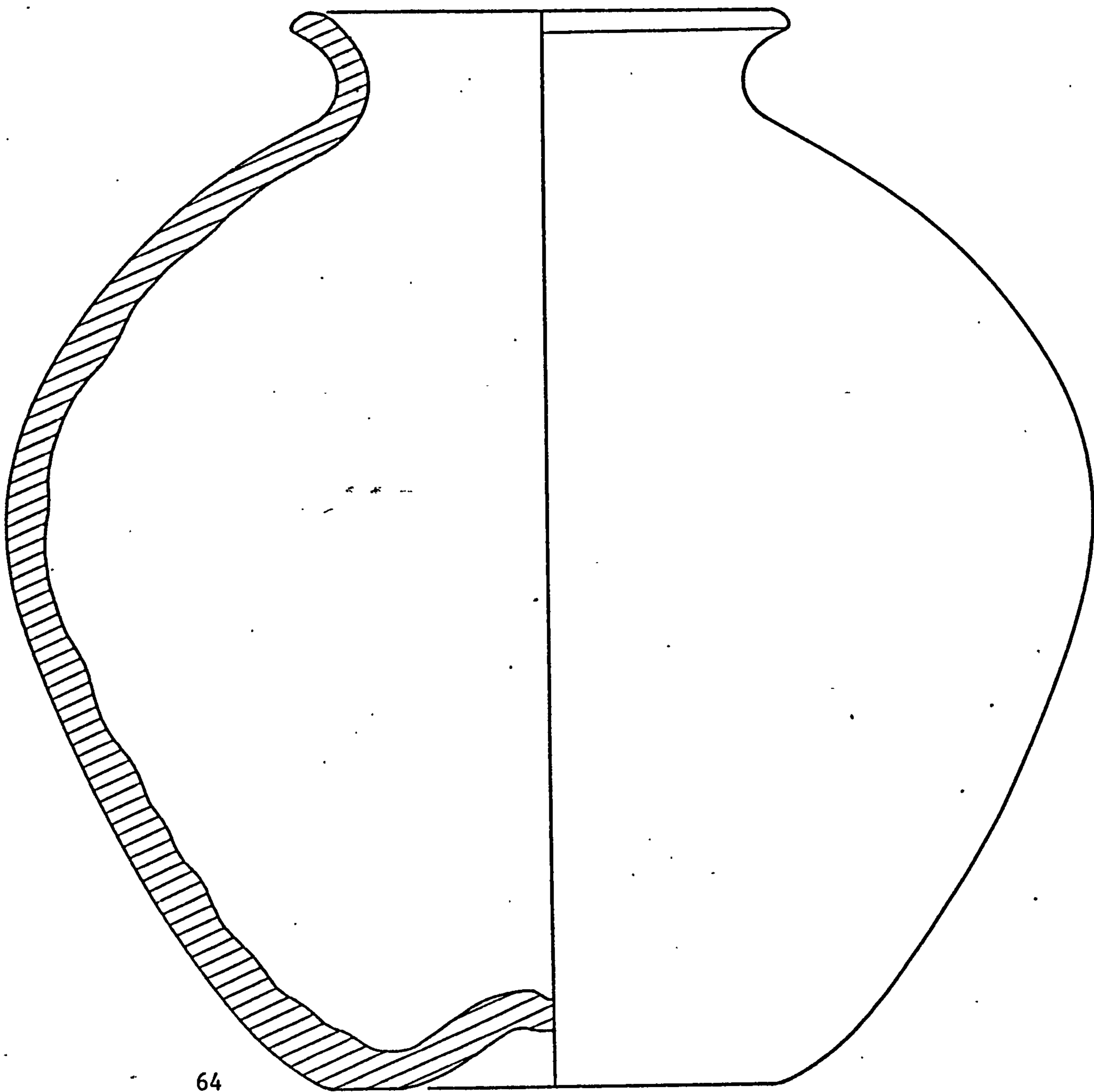

64

Plate 53: ALCÁCER DO SAL

0 10 cm

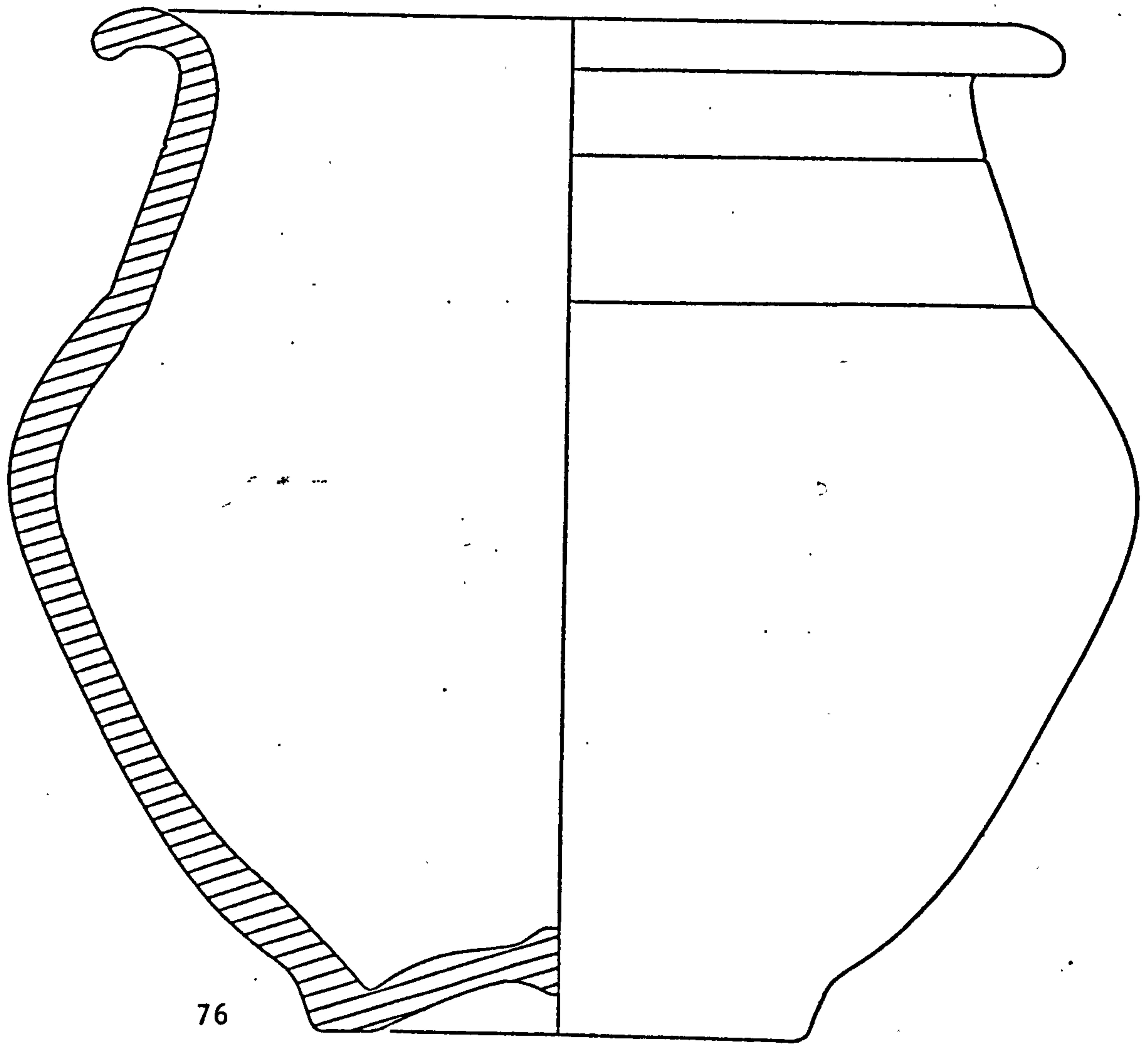

76

Plate 54: ALCÁCER DO SAL

0 10 cm

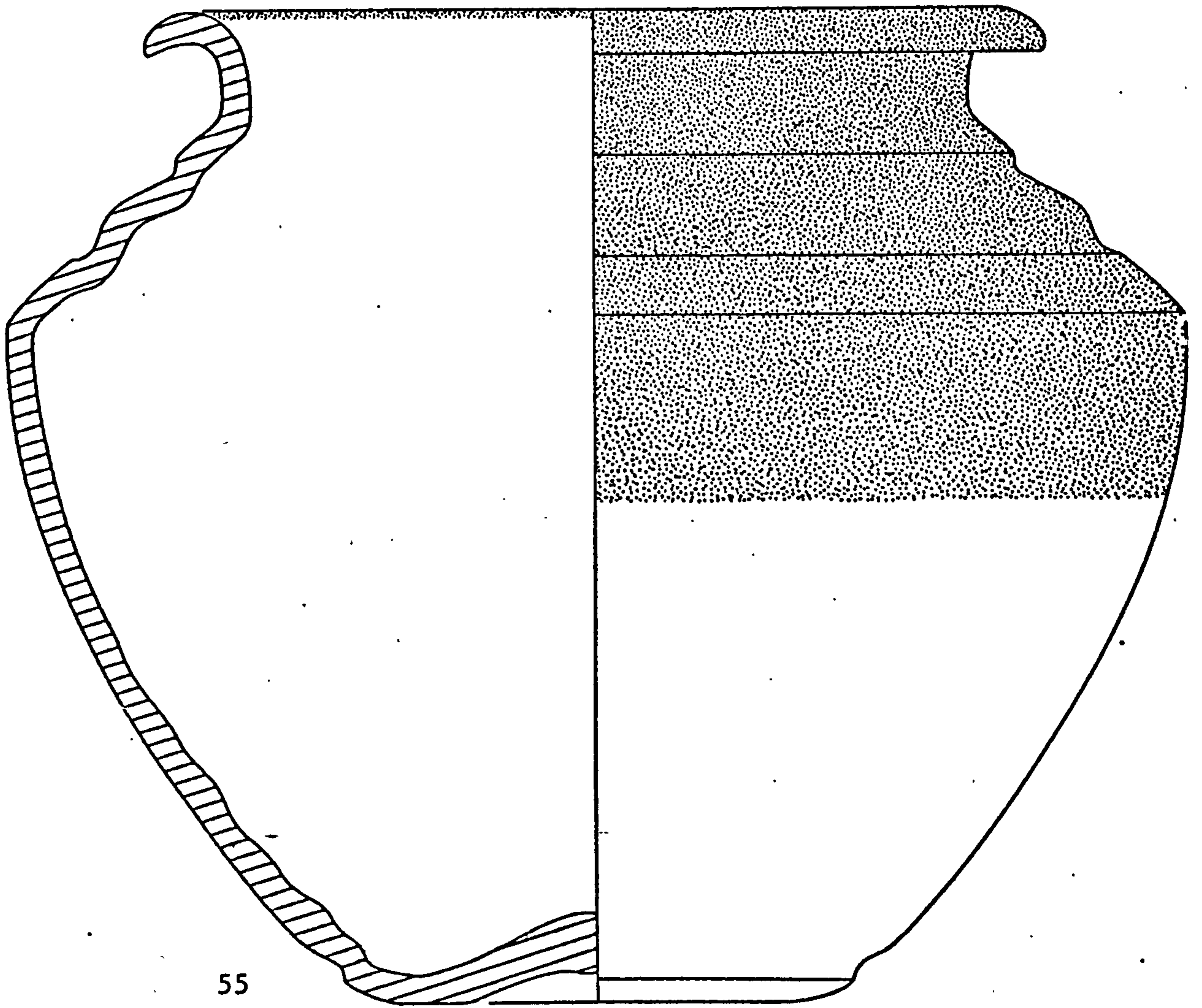
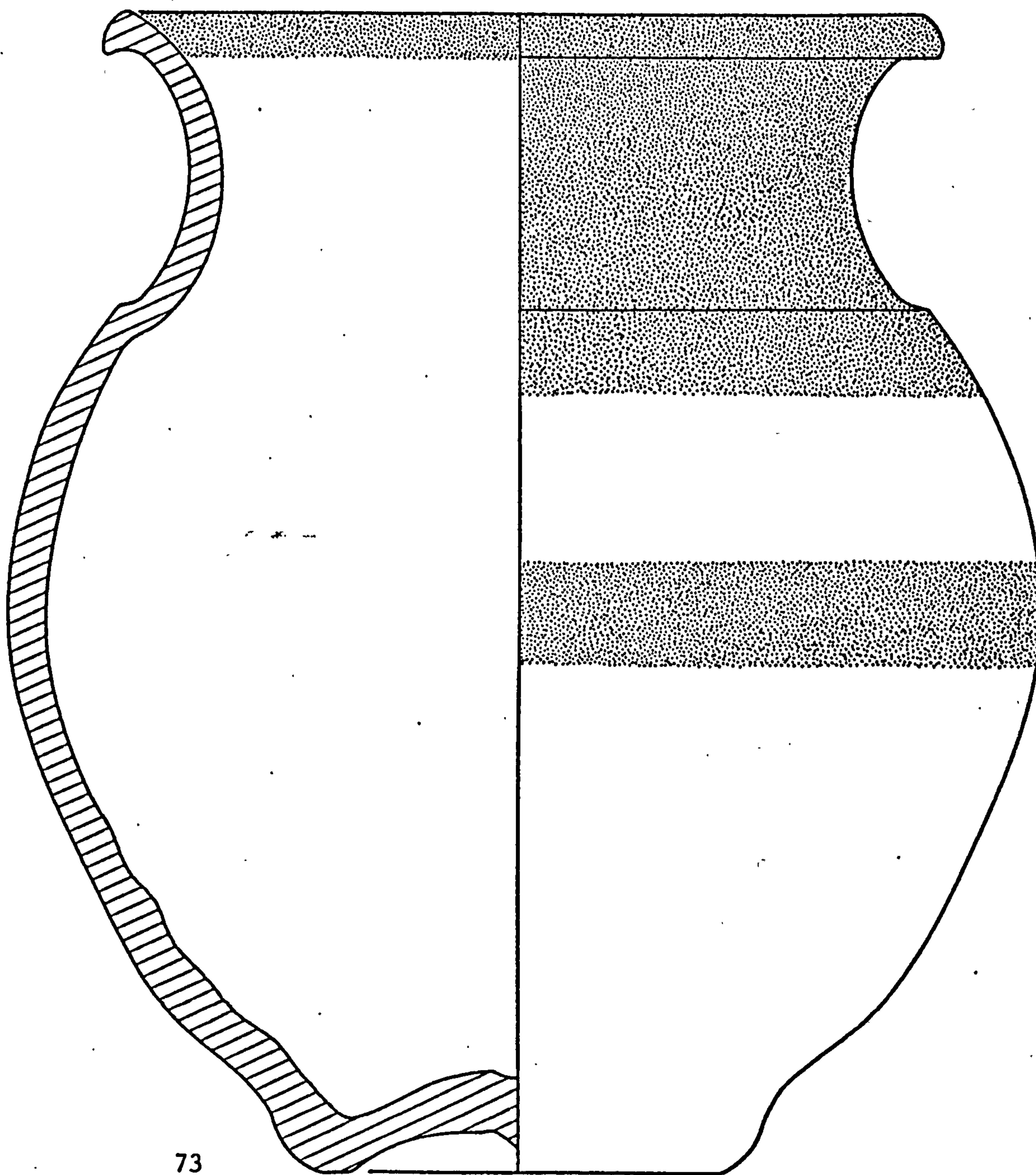

Plate 55: ALCÁÇER DO SAL

0 10



73

Plate 56: ALCÁ CER DO SAL

0 10 cm

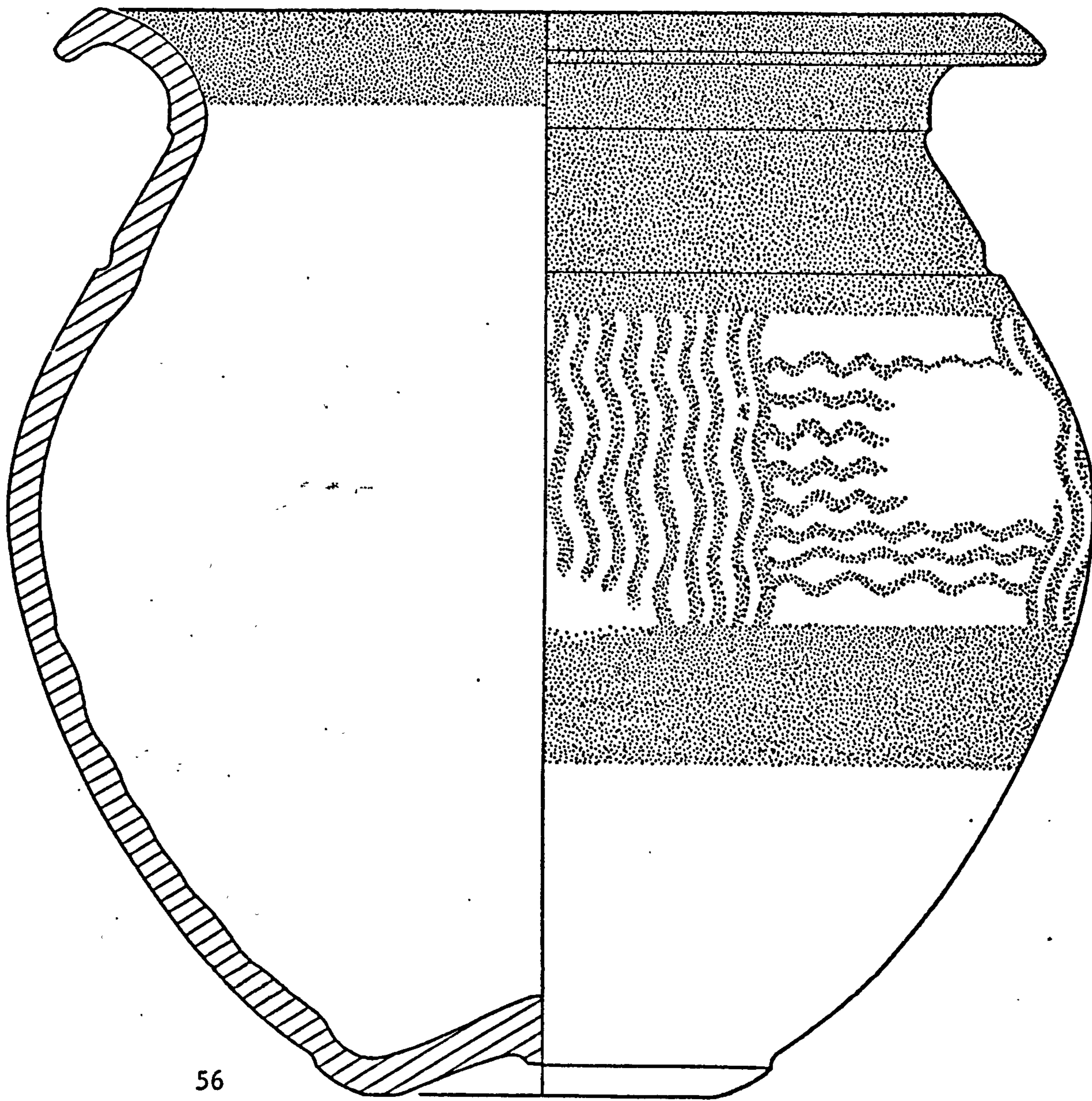
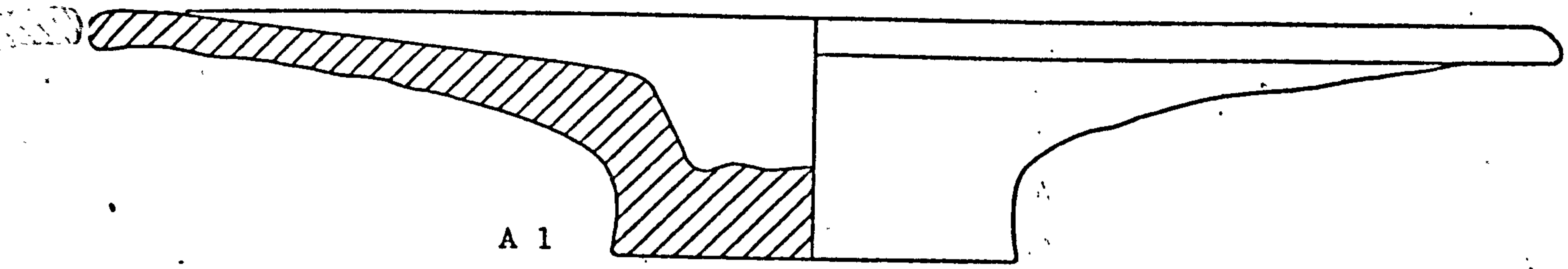
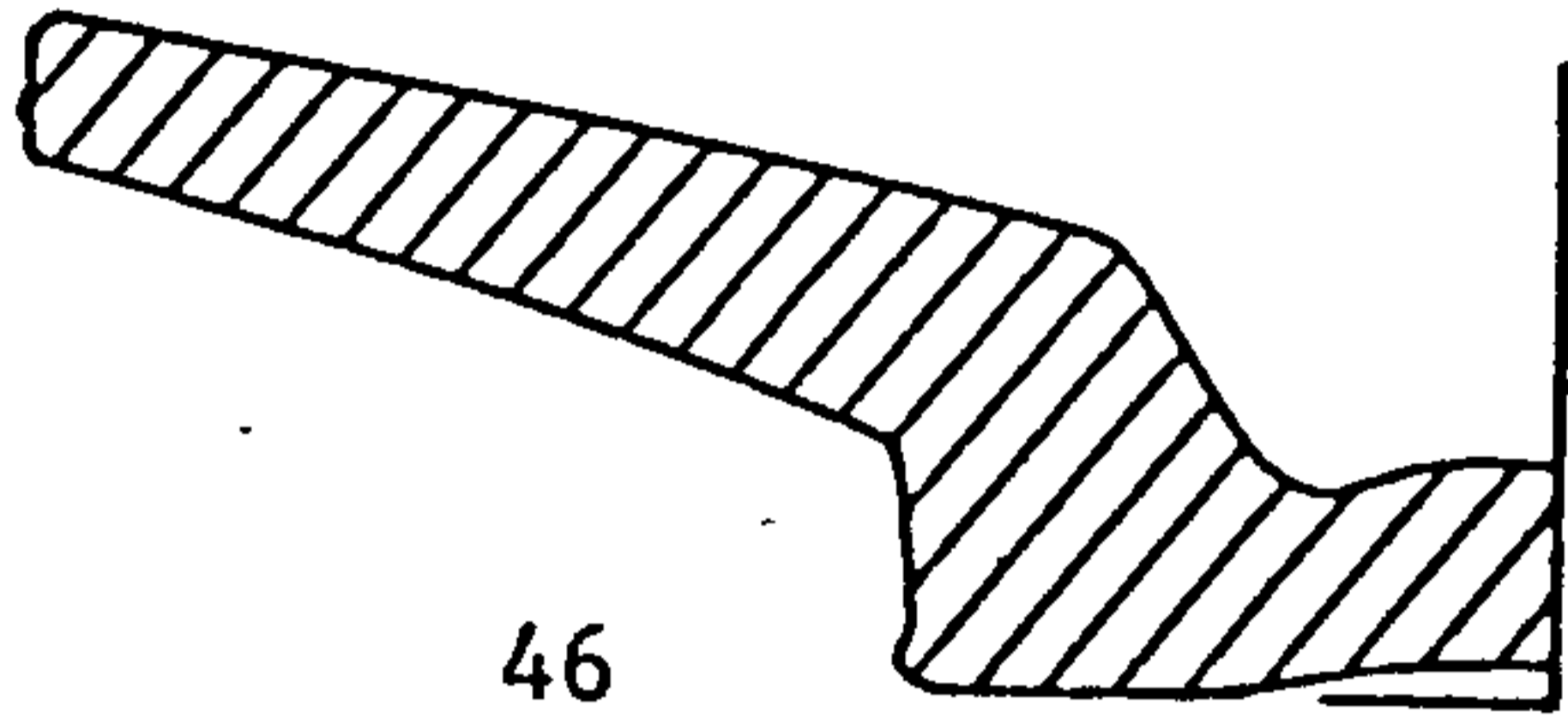

Plate 57: ALCÁCER DO SAL

0 10 cm



A 1



46

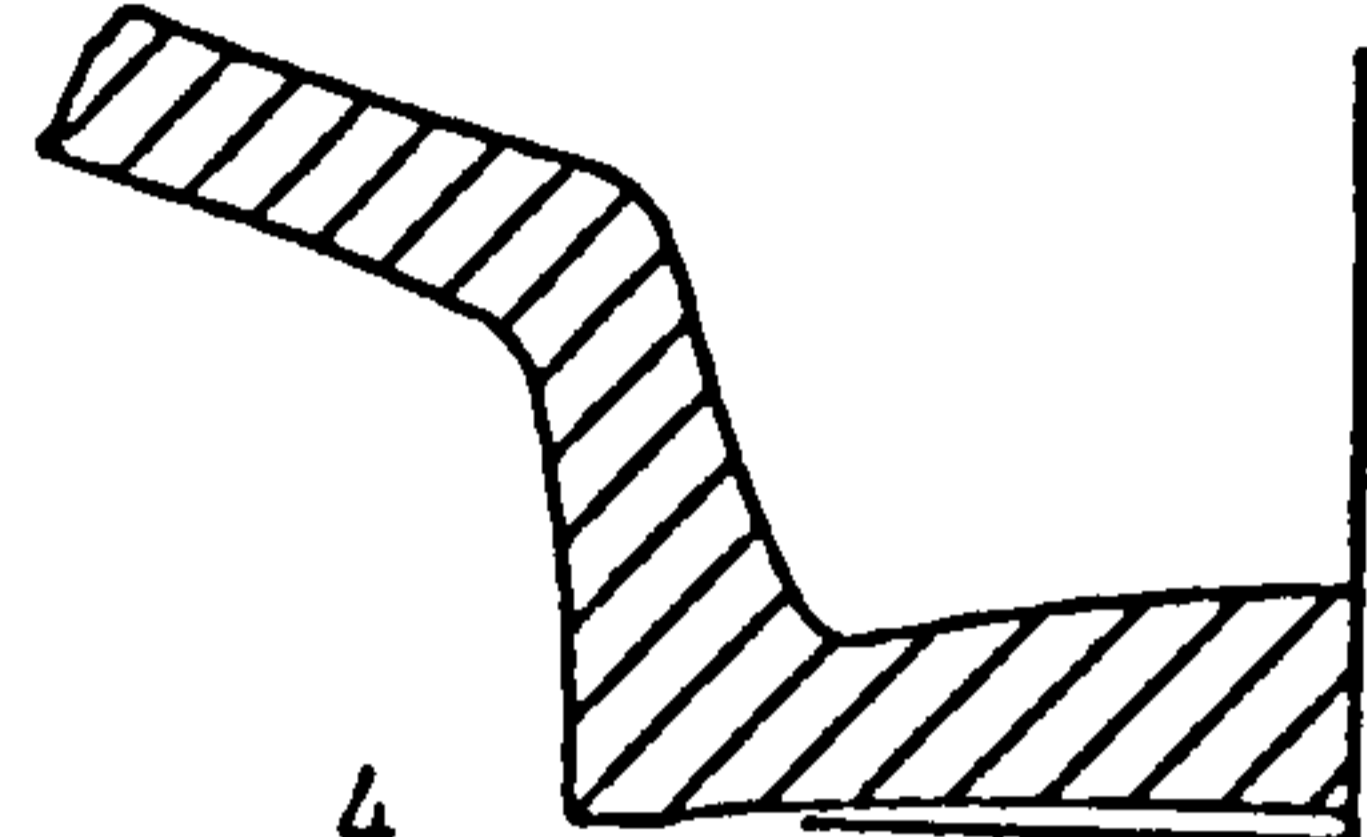

4

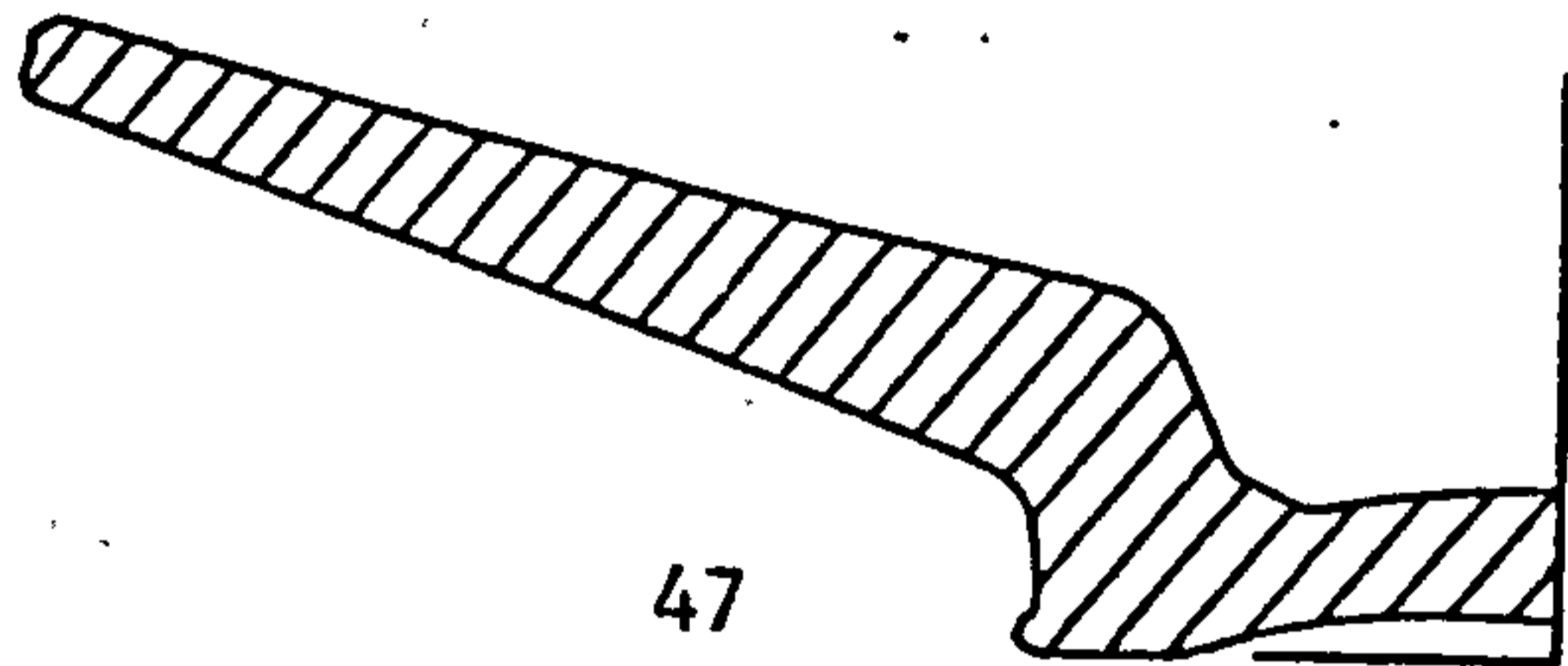

47

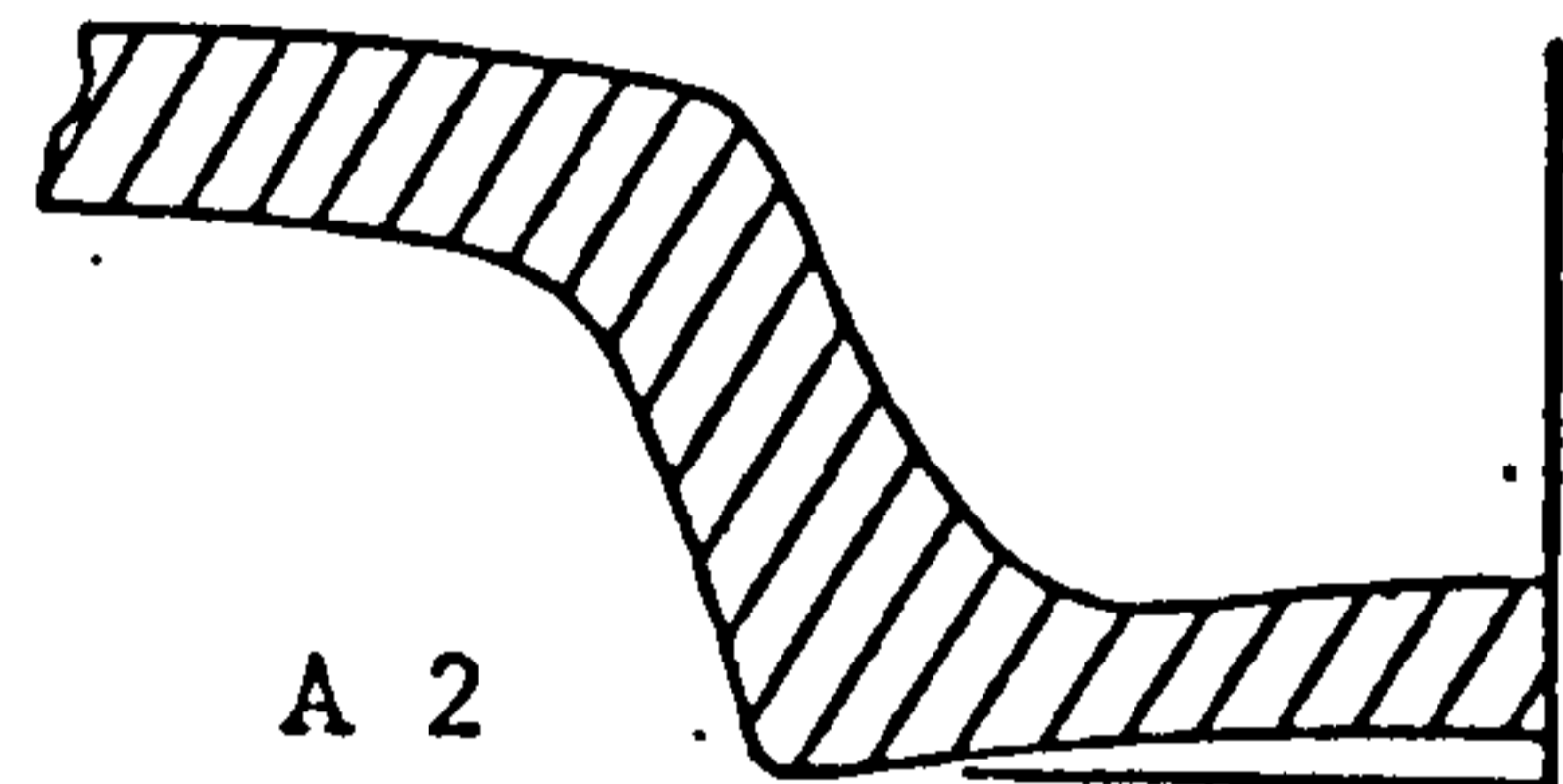

A 2

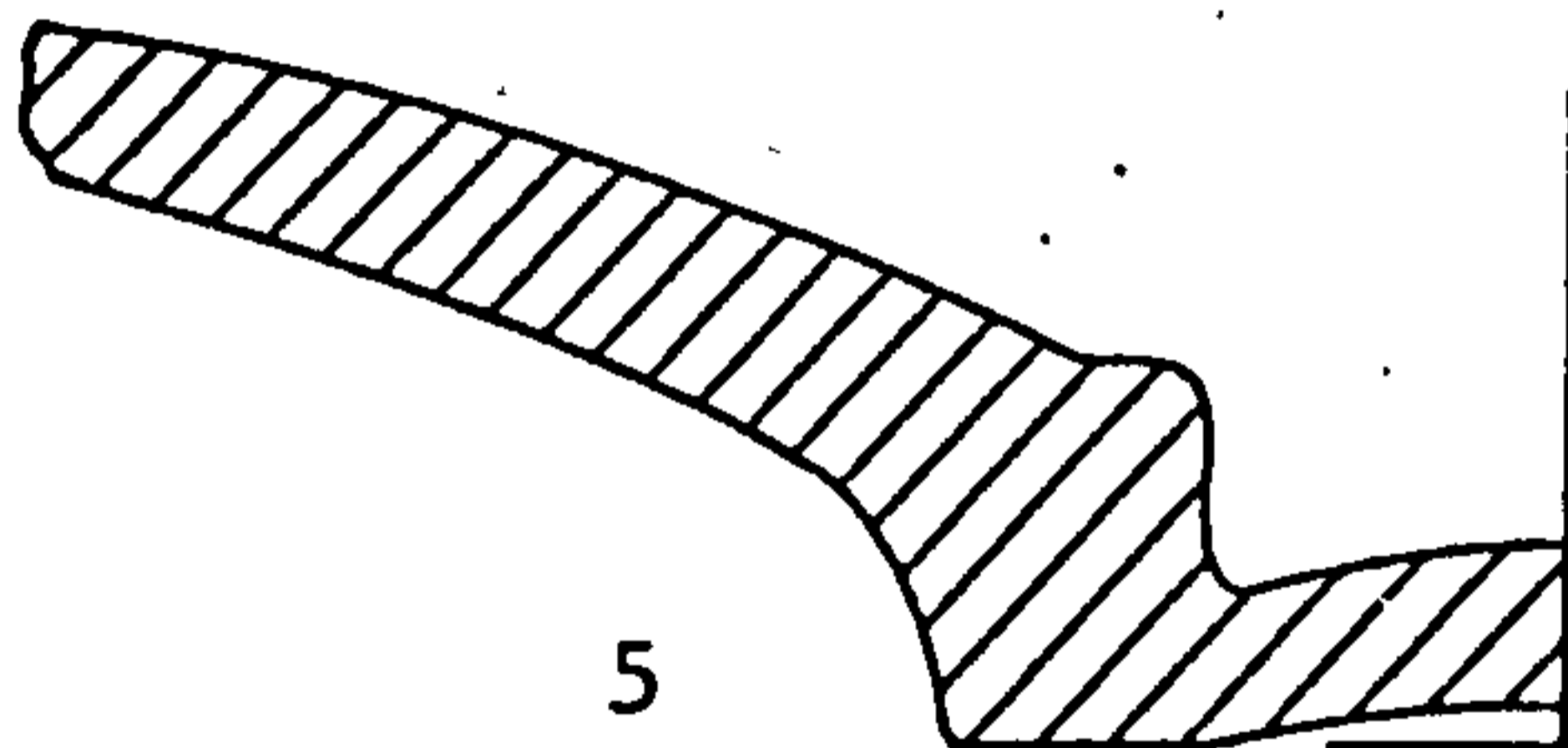

5

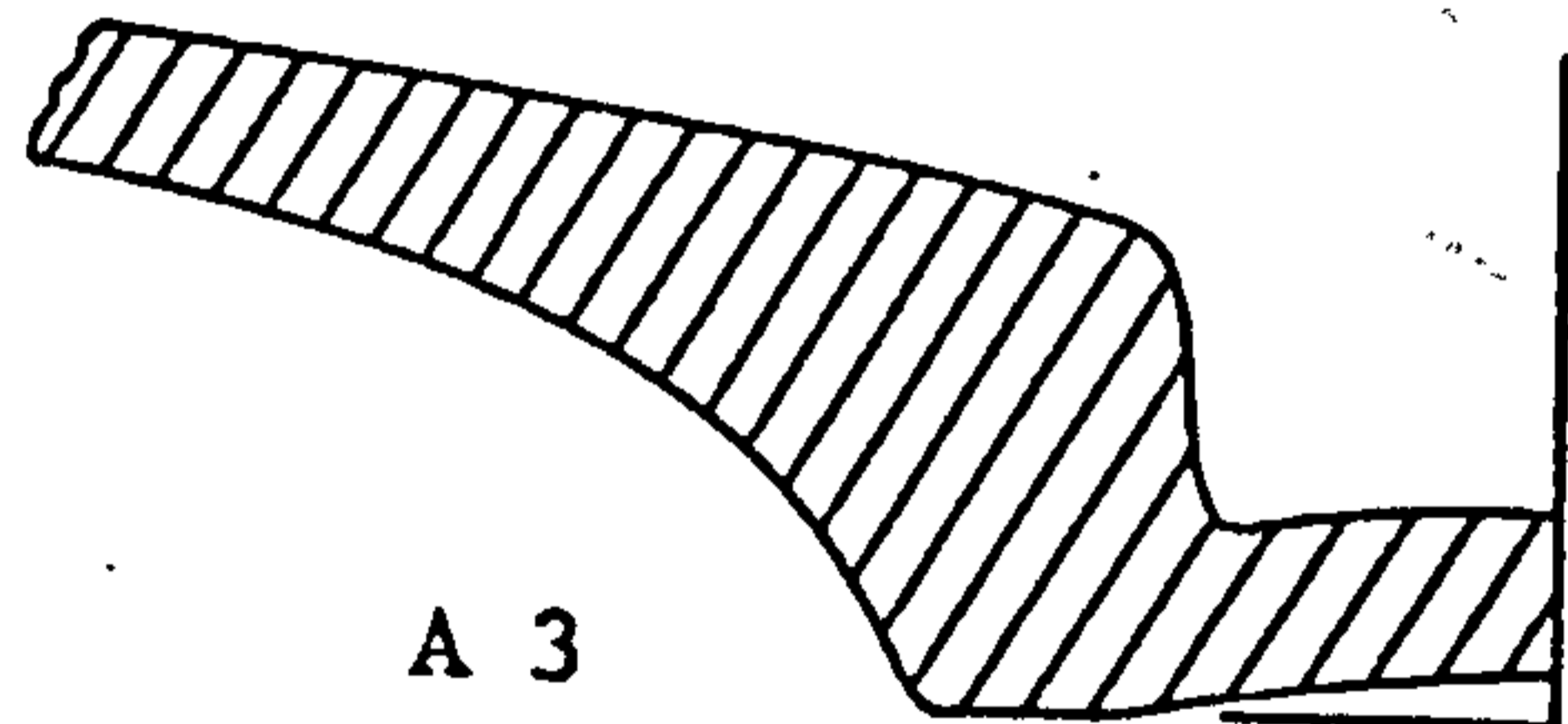

A 3

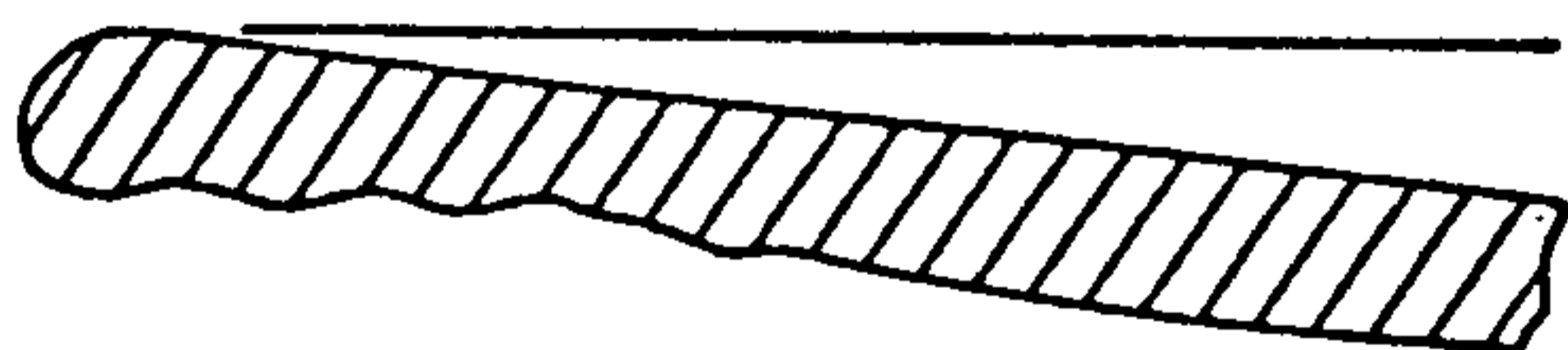

30

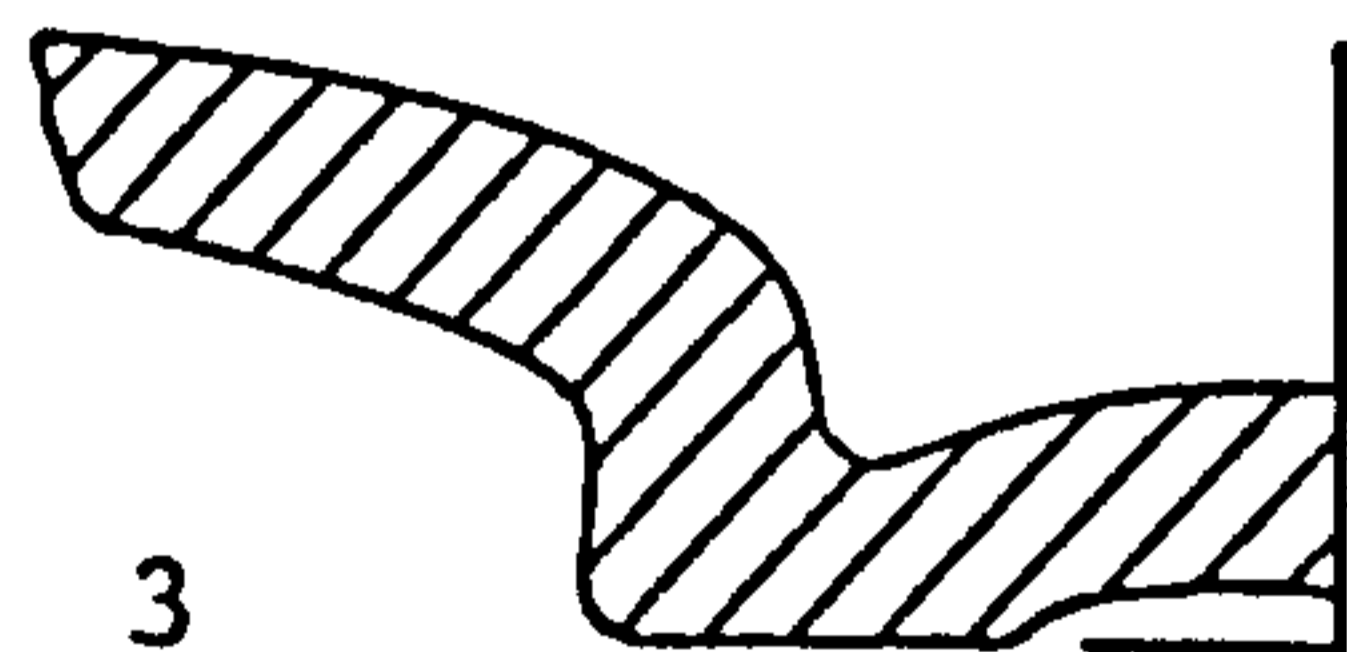

3

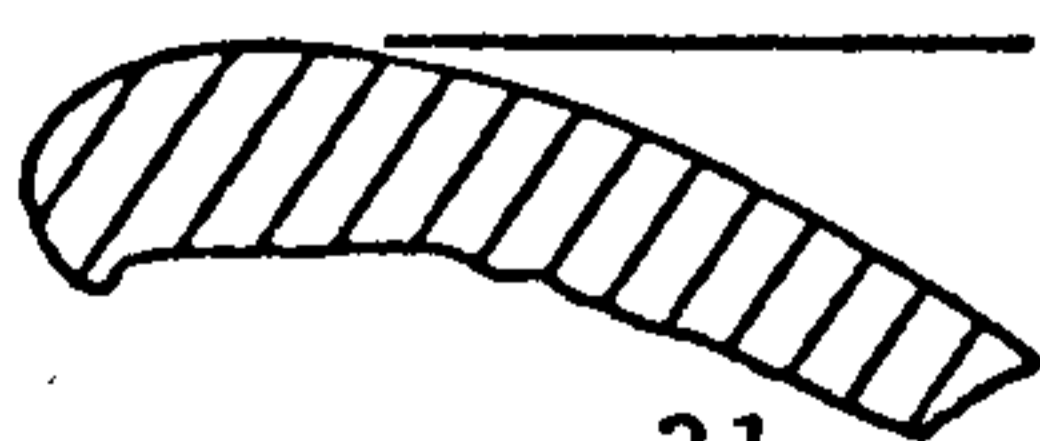

31

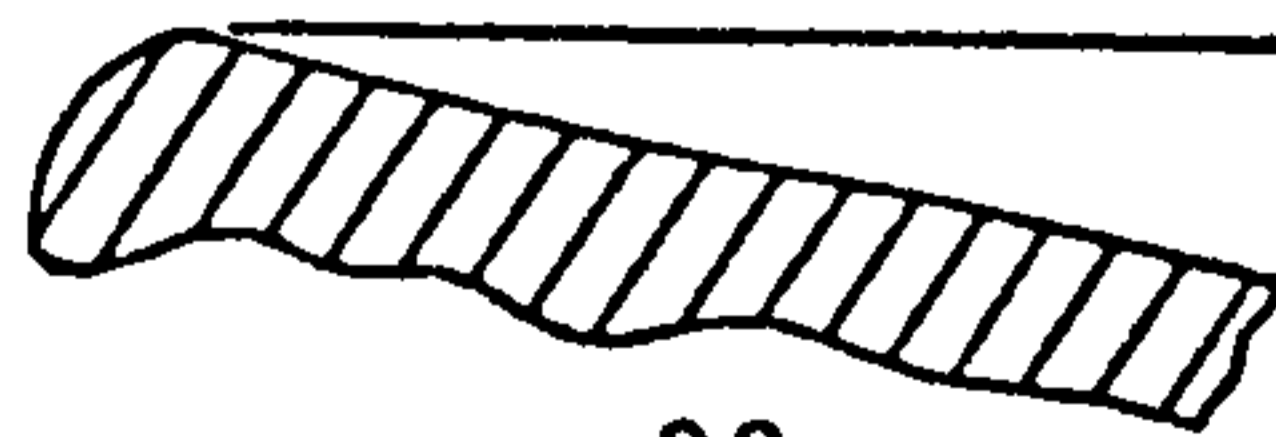

32

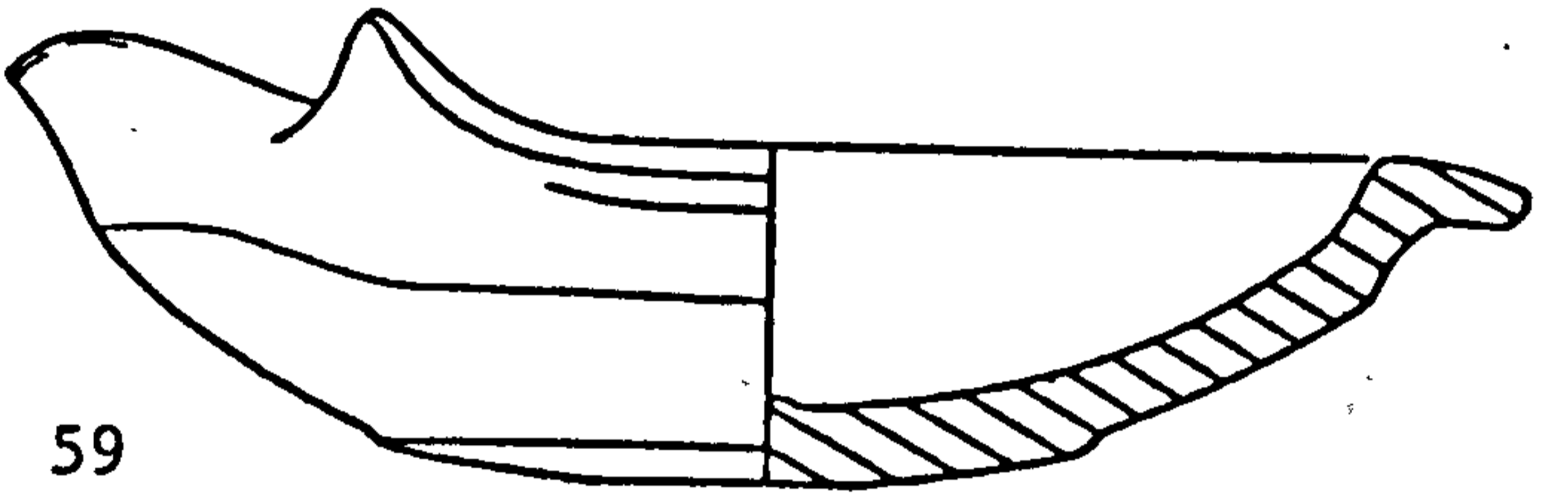
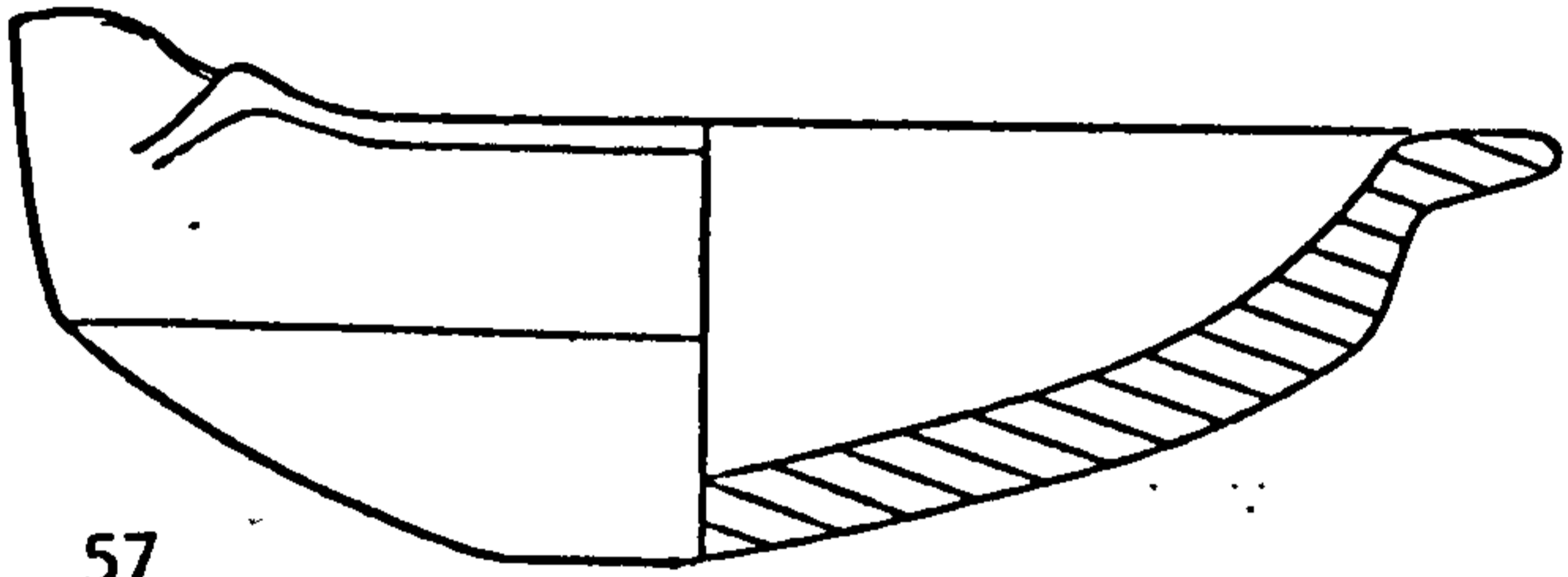
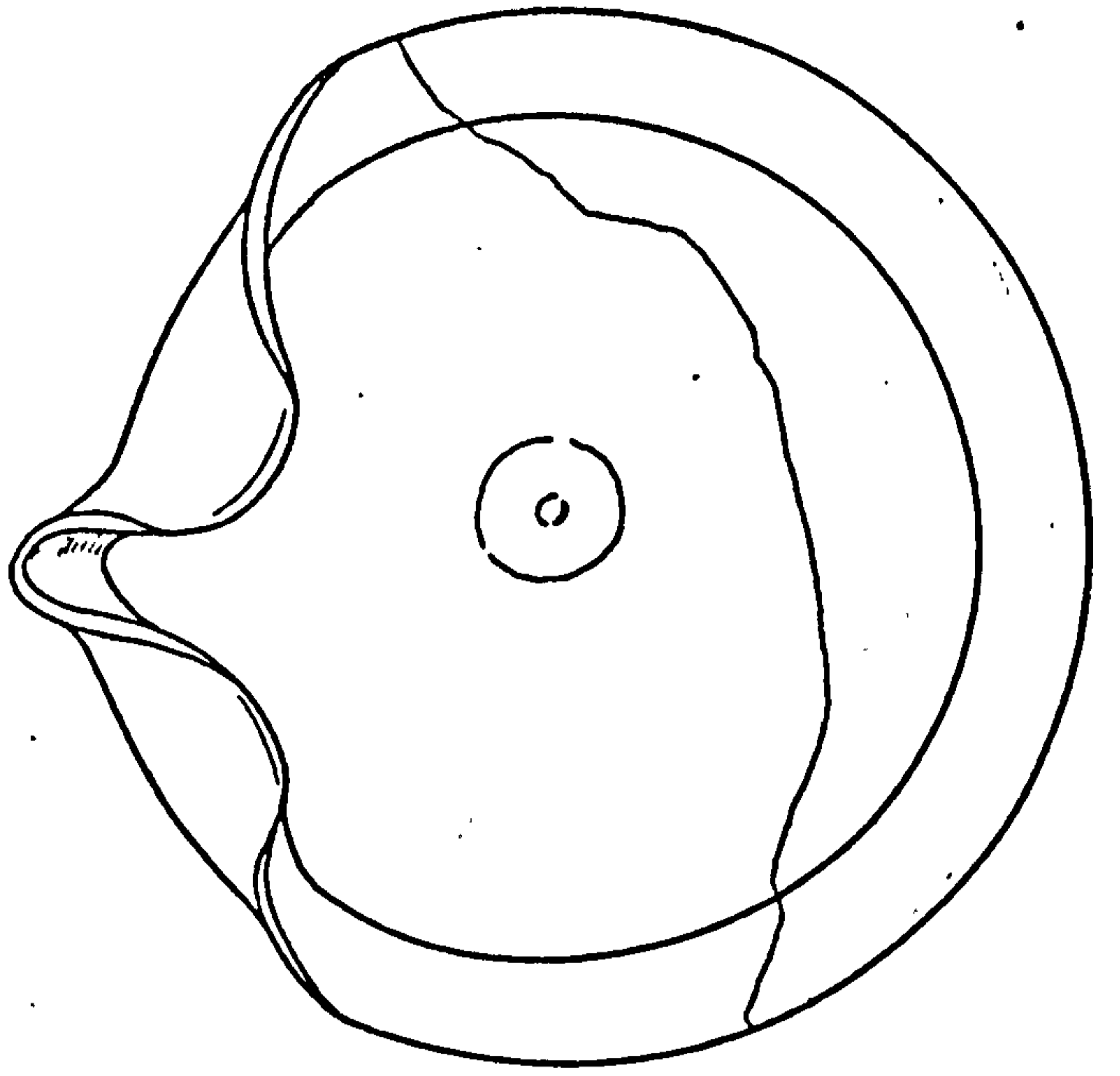
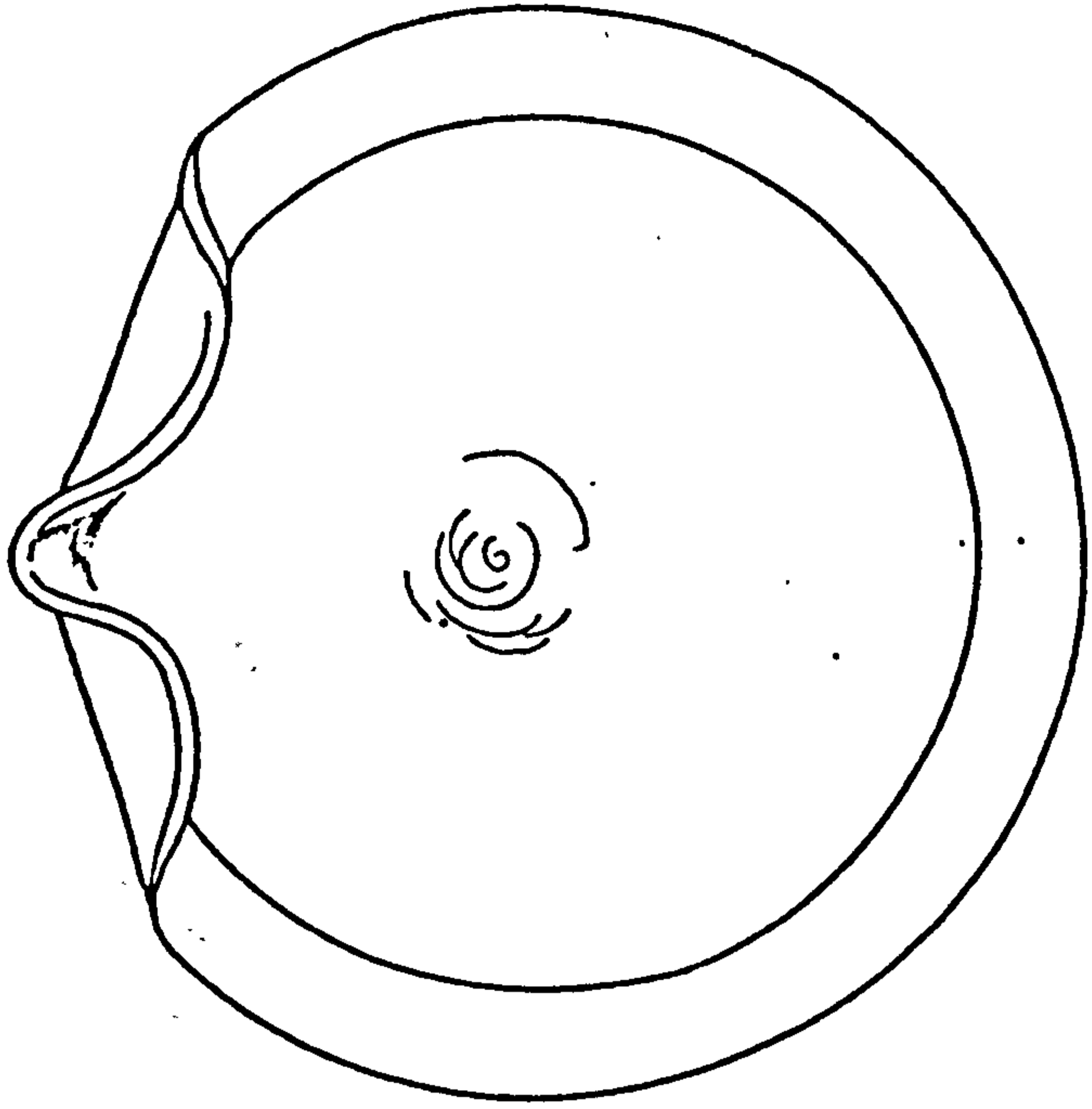

57

59

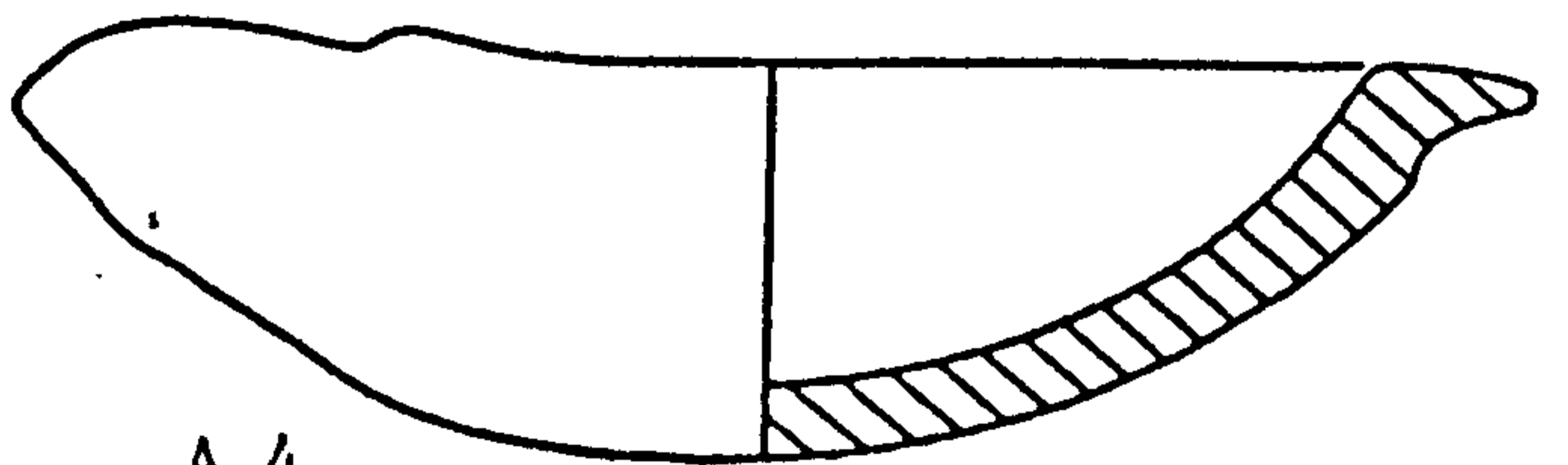
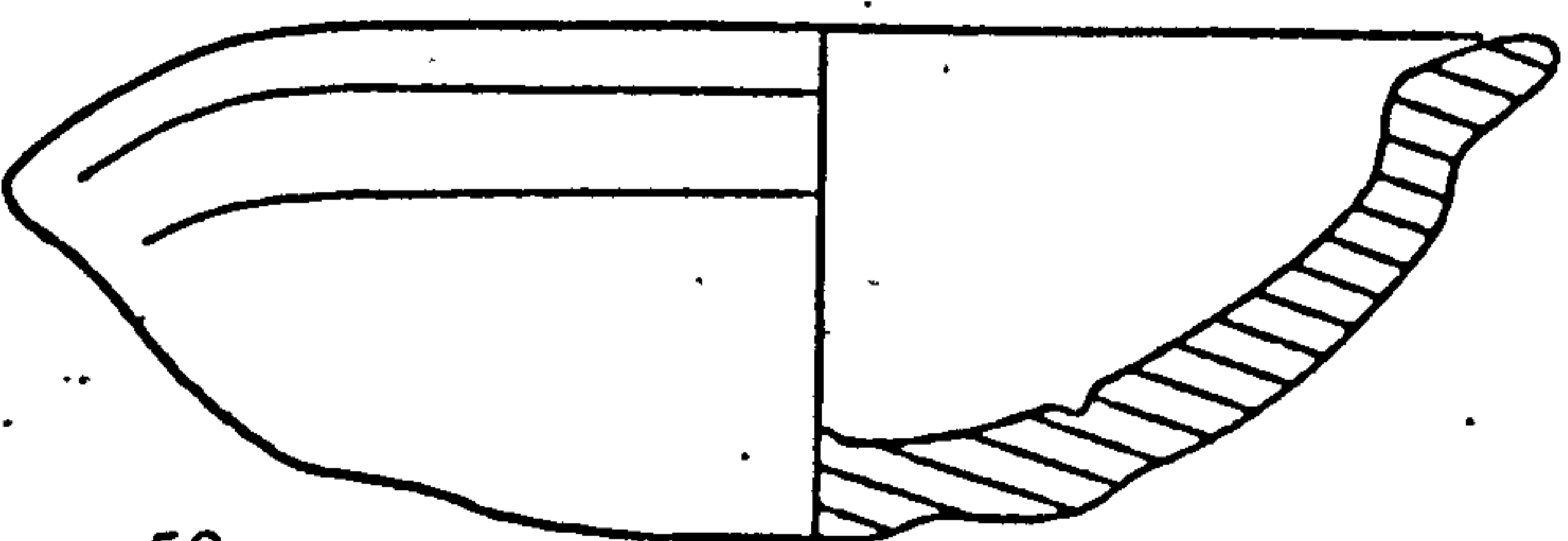
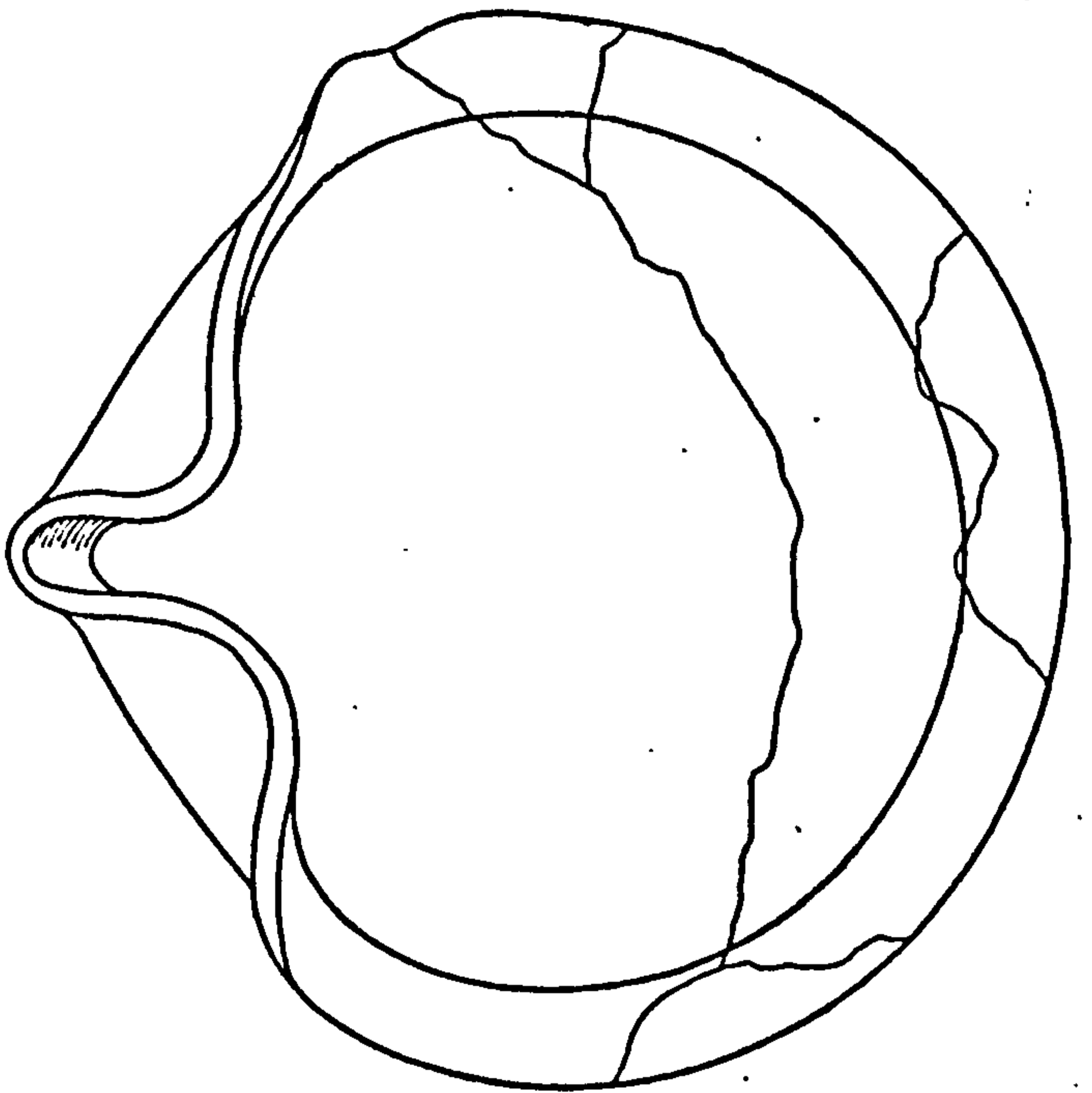
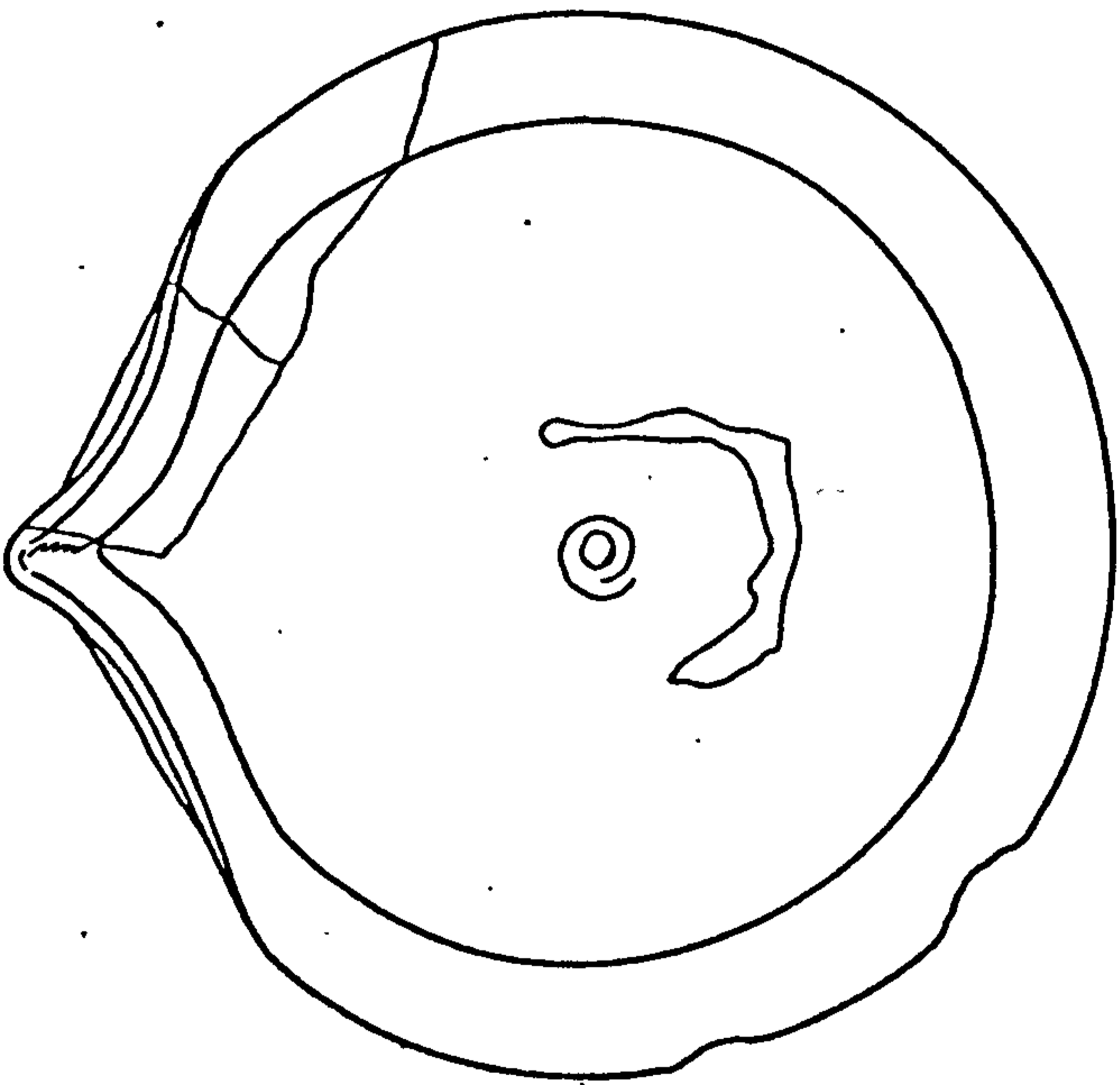

58

A 4

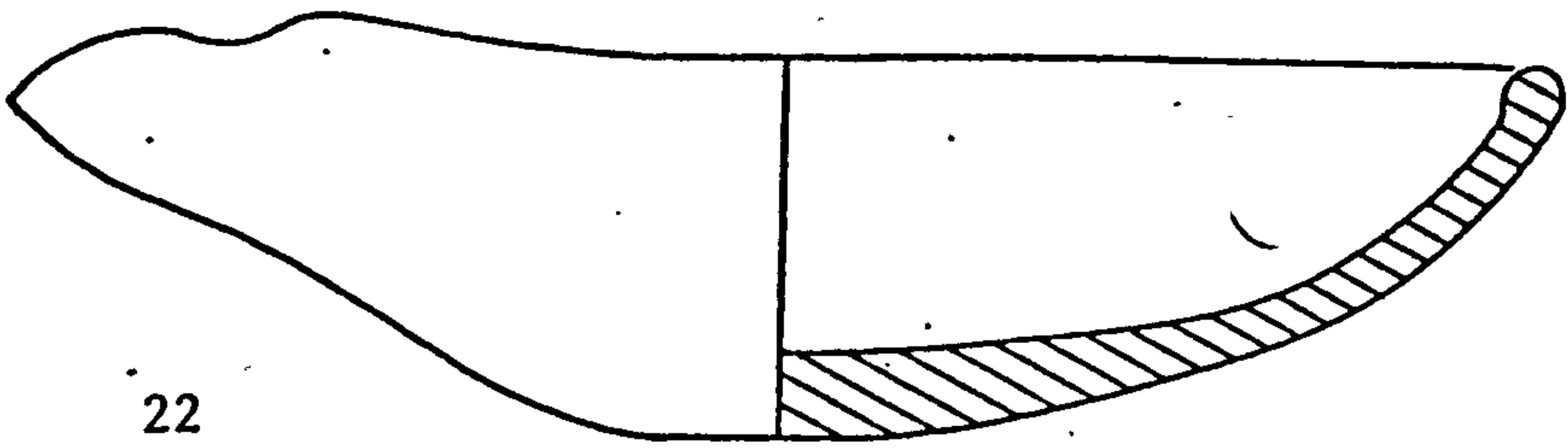
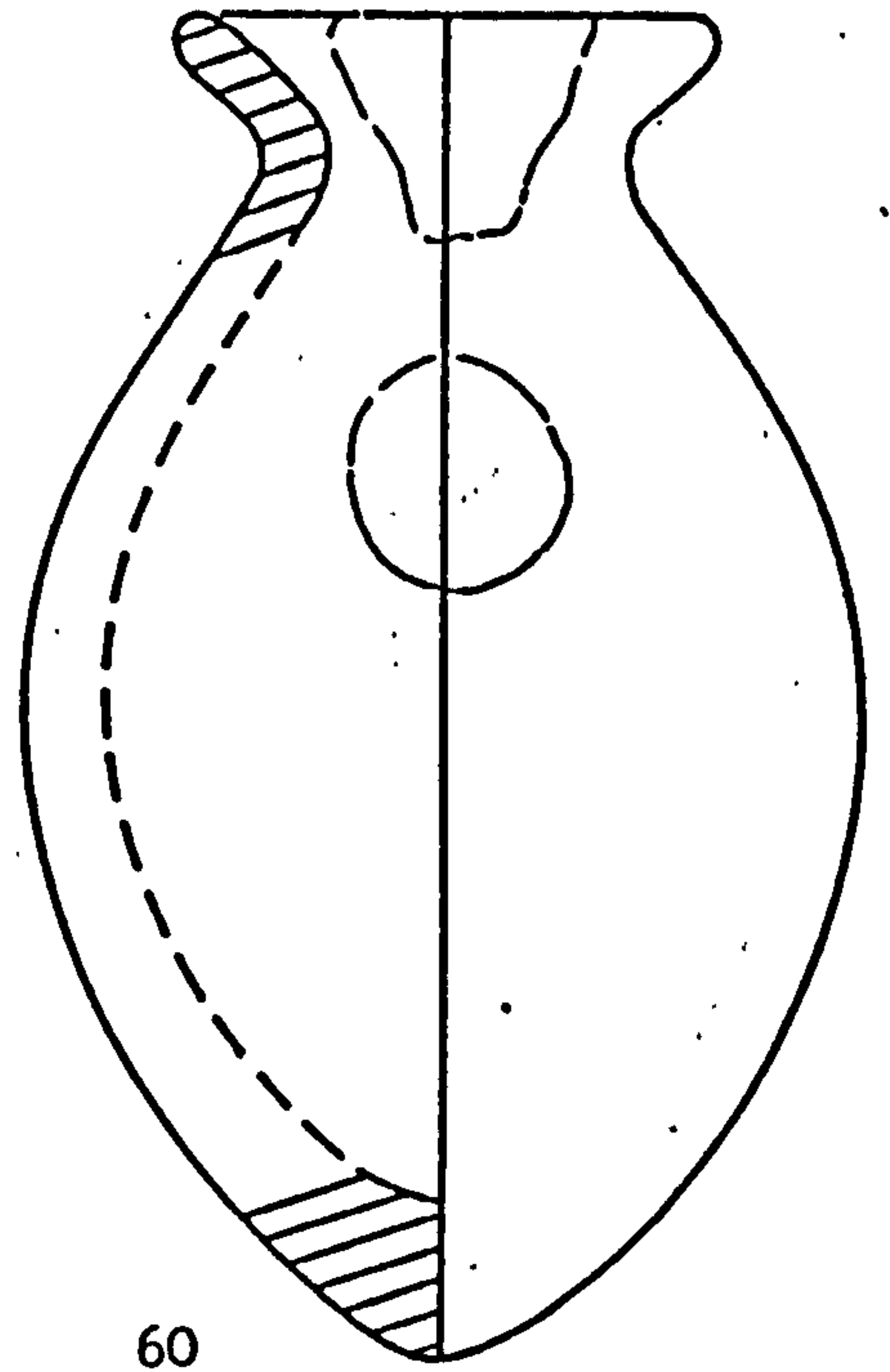
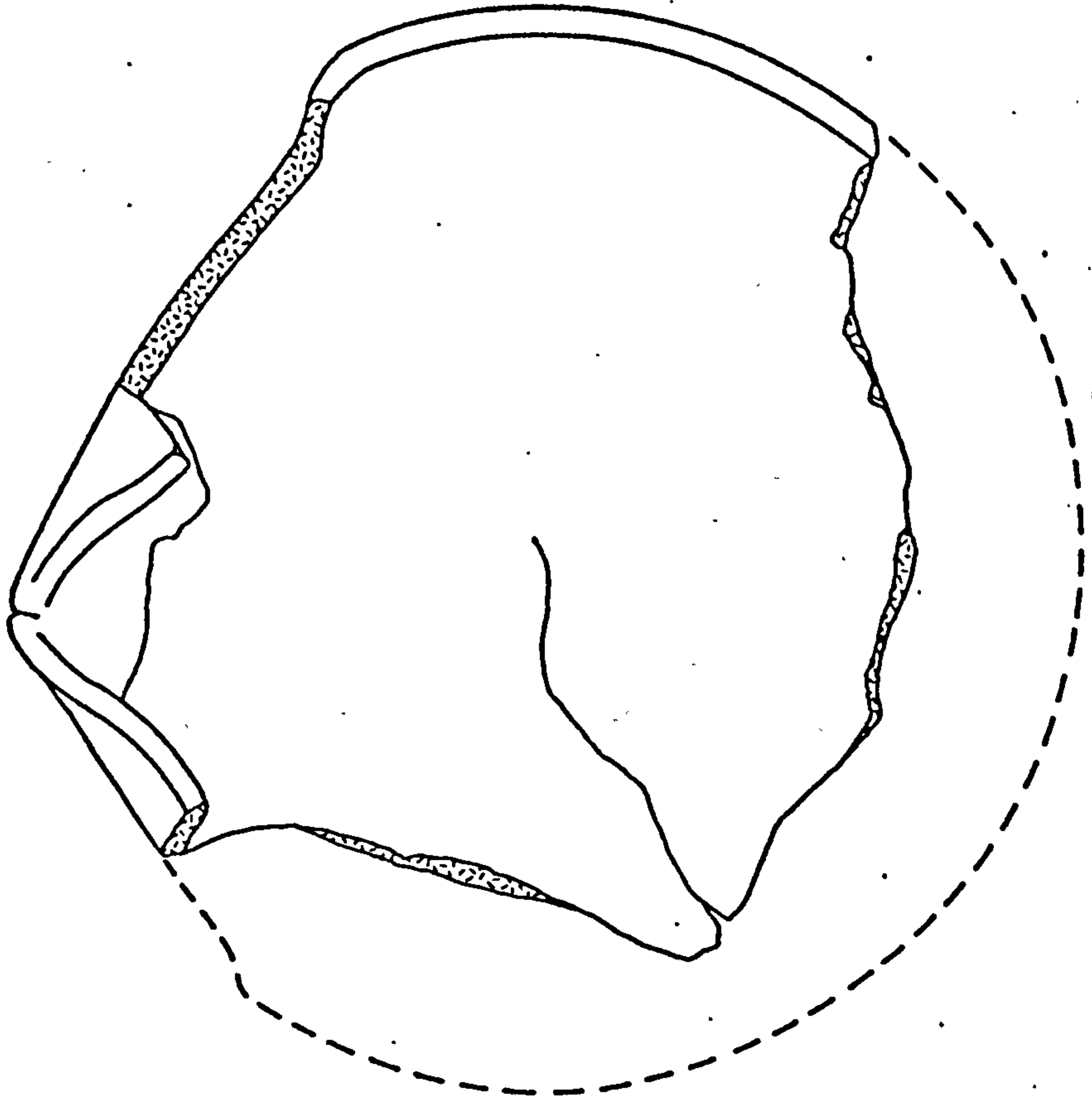

22

60

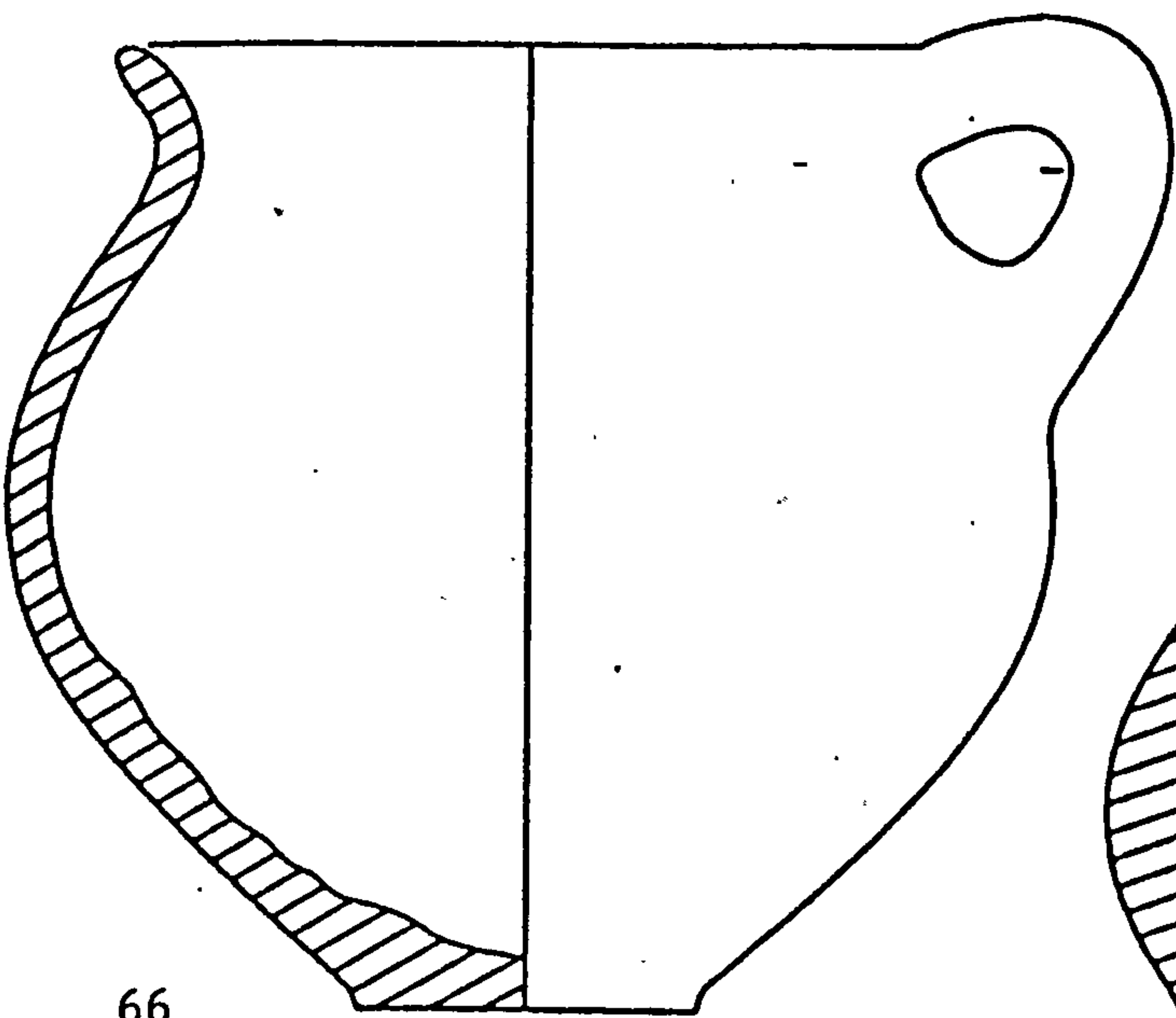

66

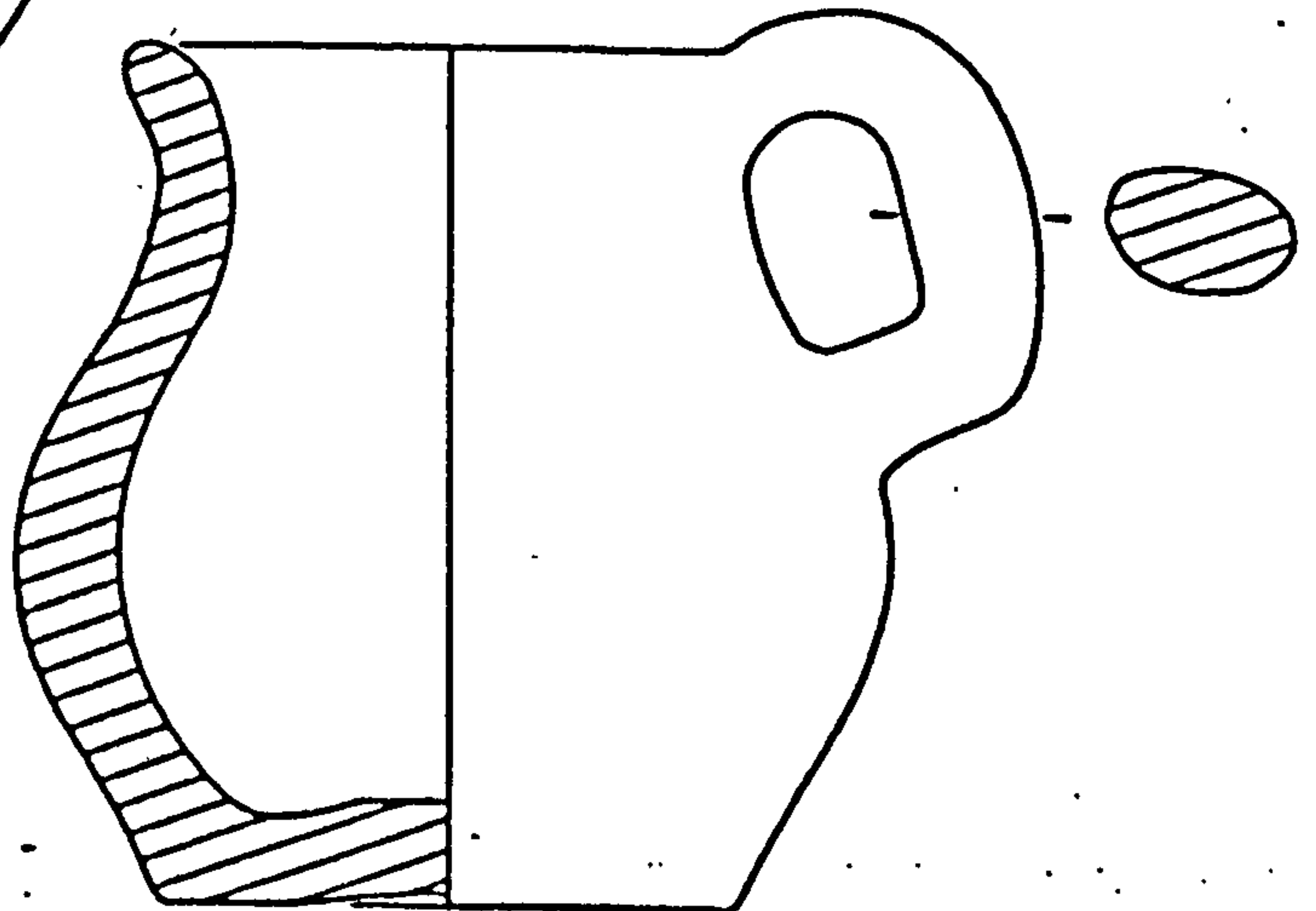

69

10 cm

0

A 5

Plate 61: ALCÁCER DO SAL

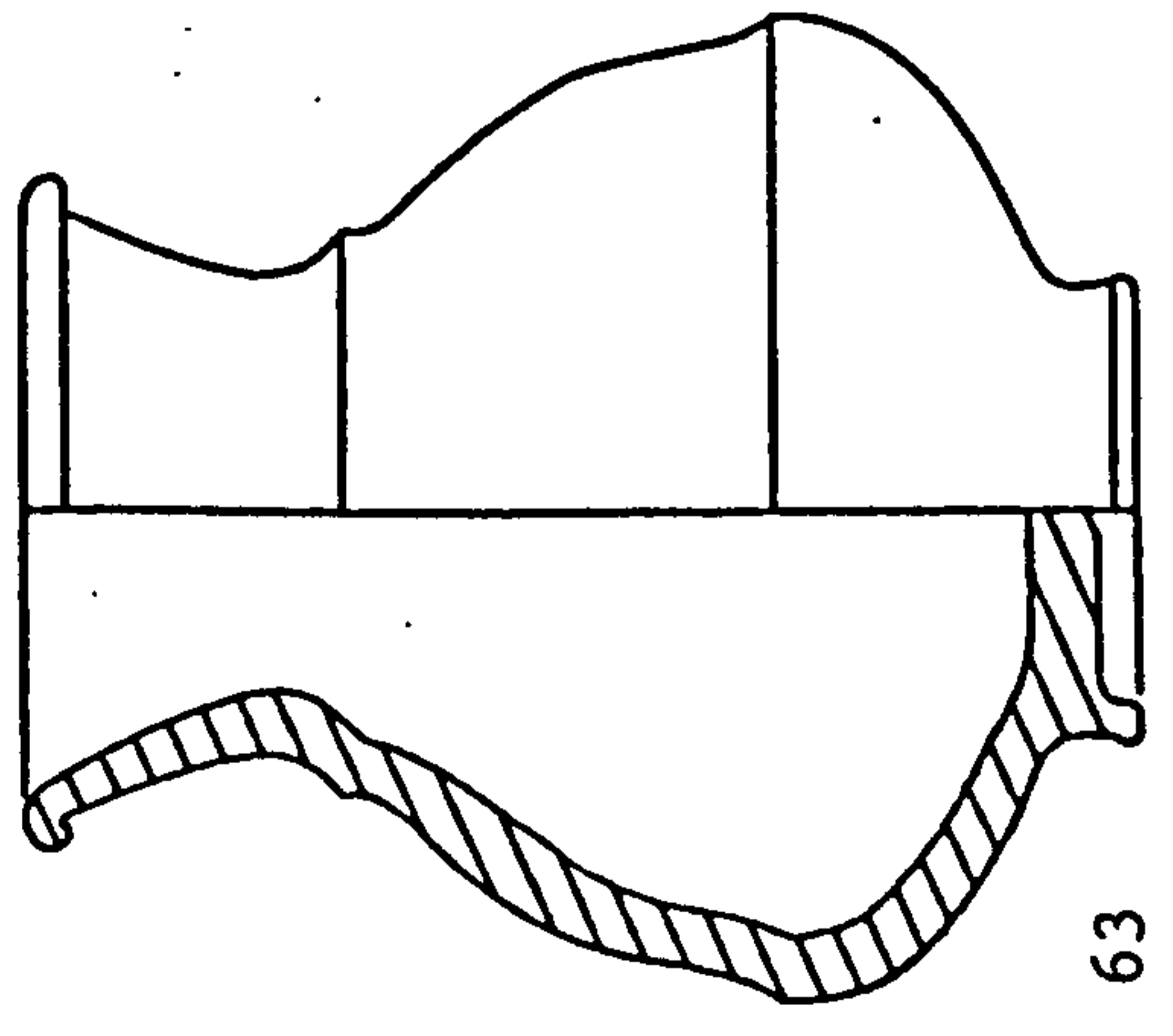

63

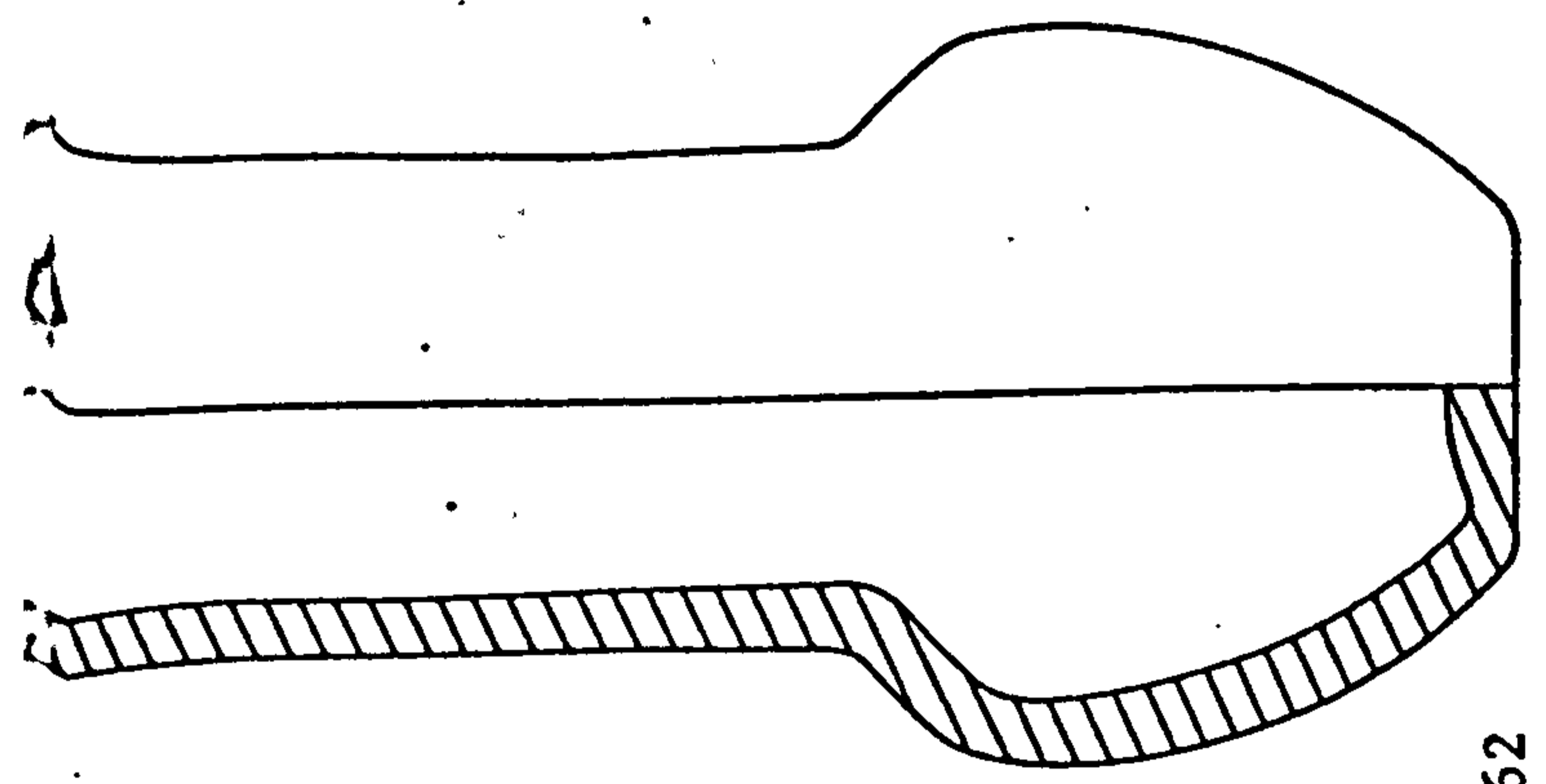

62

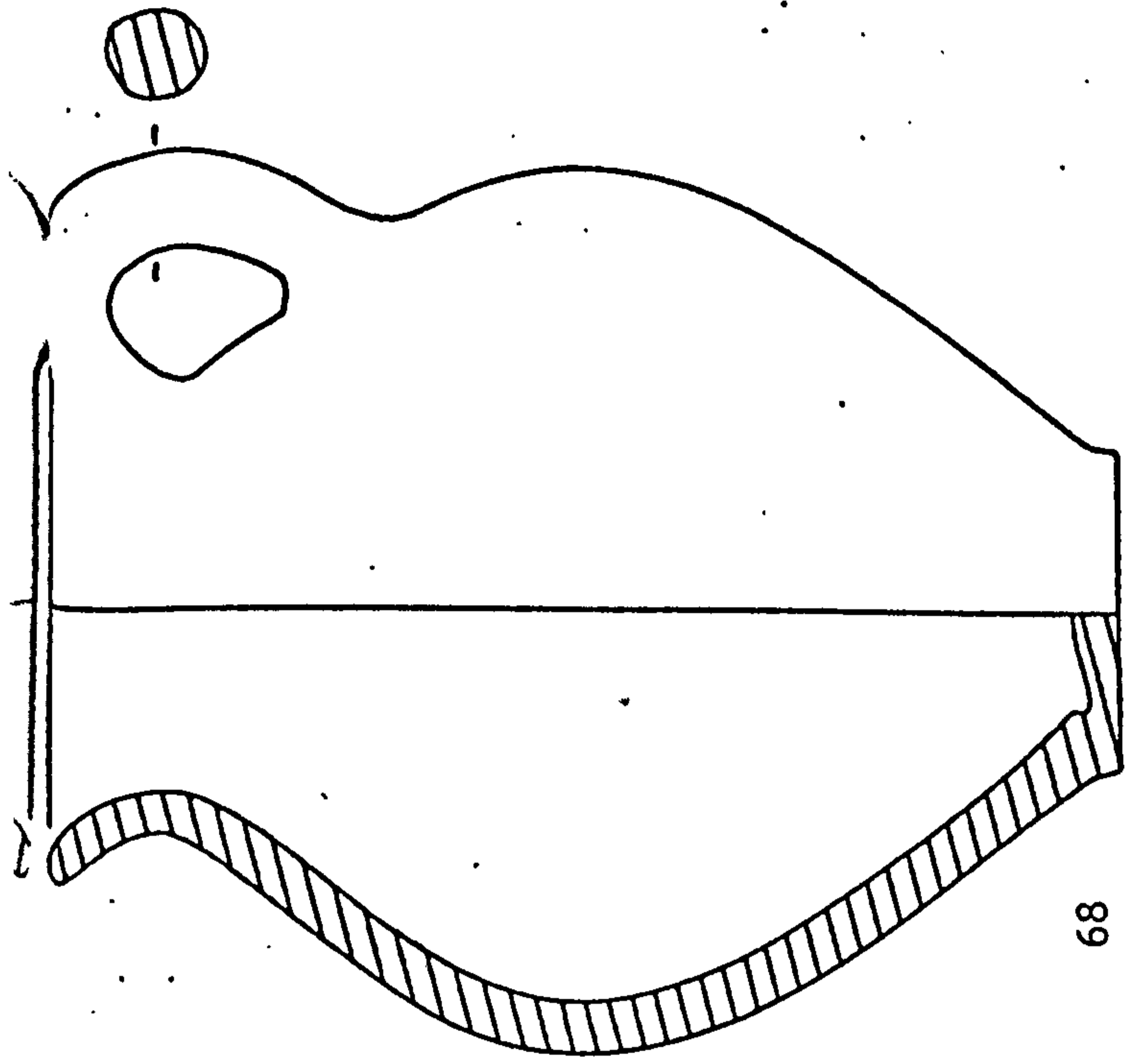

68

