



Understanding lives –  
now and for the future

# **Standard Operating Procedures: Adult Eyes and Vision Assessment**

## **EDITORS**

Suzanne Walton  
Carol Dezateux

## **AUTHORS**

Dipesh Patel  
Suzanne Walton  
Nicola Foster  
Phillippa Cumberland  
Jugnoo Rahi

## Acknowledgements

The Life Study Standard Operating Procedures (SOPs) for Adult Eyes and Vision Assessment were written by Dipesh Patel, Dr Suzanne Walton, Nicola Foster, Dr Phillippa Cumberland and Professor Jugnoo Rahi, Life Course Epidemiology and Biostatistics, UCL Institute of Child Health.

The Life Study Scientific Steering Committee is responsible for approving the final edited content of this document. They and the editors thank the authors and members of the Life Study Neurodevelopment Group for giving generously of their time and expertise in assisting with the development and writing of the Life Study SOPs for Adult Eyes and Vision Assessment and for their support at the time of the Life Study pilot, and advice and assistance with equipment required and its installation and training in its use at the first Life Study Centre.

### Members of the Life Study Neurodevelopment Group

Professor Tony Charman  
Dr Debbie Colson  
Professor Carol Dezateux  
Professor Alan Emond (chair)  
Nicola Foster  
Professor Dale Hay

Professor Mark Johnson  
Professor Catherine Peckham  
Professor Jugnoo Rahi  
Dr Tim Smith  
Dr Suzanne Walton

### Members of the Life Study Scientific Steering Committee

Professor Peter Brocklehurst  
Professor Simon Burgess  
Professor Carol Dezateux  
Professor Peter Elias  
Professor Paul Elliott  
Professor Alan Emond

Professor Hilary Graham  
Professor Frank Kelly  
Professor Kathleen Kiernan  
Professor David Leon  
Professor Diane Reay  
Professor Anna Vignoles (chair)

This work was supported by the Economic and Social Research Council [Grant numbers ES/J007501/1, ES/L002507/1, ES/L002353/1, ES/L012871/1, and ES/N007549/1].

ISSN 2398-1652. DOI: 10.14324/000.wp.1485678

URL: <http://discovery.ucl.ac.uk/1485678/>



Life Study Working Papers are licensed under a [Creative Commons Attribution-NonCommercial-NoDerivatives 4.0 International License](https://creativecommons.org/licenses/by-nc-nd/4.0/)

## Contents

1	Background .....	5
2	Aim.....	6
3	Subjects .....	6
	3.1 Inclusion criteria.....	6
	3.2 Exclusion criterion.....	6
4	Staff undertaking the assessment .....	7
5	Environment.....	7
6	Equipment.....	7
	6.1 PlusoptiX A09 Autorefractor.....	7
	6.2 Frisby Stereotest. ....	10
	6.3 Digital camera.....	11
	6.3.1 Camera Settings .....	12
	6.4 Auto Focimeter .....	13
7	Preparation .....	14
8	Summary of protocol .....	16
9	Measurement using the plusoptiX device.....	21
	9.1 PlusoptiX Top Tips .....	31
	9.2 Troubleshooting measurements using the plusoptiX device .....	33
	9.2.1 Outcomes of a plusoptiX measurement.....	33
	9.2.2 Key Points.....	35
	9.2.3 Troubleshooting ‘Environmental factors’ .....	37
10	Measurement with the Frisby stereotest .....	38
	10.1 Frisby Stereotest Top Tips .....	41
11	Photograph of the participant’s eyes .....	43
	11.1 Photography Top Tip .....	47
12	Manual recording of refractive error.....	48
13	Assessing participants’ glasses .....	49
	13.1 Equipment .....	49
	13.2 General Procedure .....	49
	13.3 Measuring single vision lenses.....	50
	13.4 Measuring bifocal lenses .....	56
	13.5 Focimeter troubleshooting.....	57

14	End of the day procedures .....	57
15	Annex: Vision Assessment Survey – Mothers and Partners.....	58

## Table of Figures

Figure 1.	PlusoptiX A09 autorefractor .....	8
Figure 2.	PlusoptiX autorefractor device head.....	8
Figure 3.	PlusoptiX monitor reading.....	9
Figure 4.	Frisby stereotest plate with four images.....	10
Figure 5.	Frisby plate with white and red sticker identifiers .....	10
Figure 6.	Hidden target in one image on plate .....	11
Figure 7.	Image composition for mid-face photograph.....	11
Figure 8.	Digital camera .....	12
Figure 9.	Reichert AL-200 Autofocimeter .....	13
Figure 10.	PlusoptiX assessment setup .....	15
Figure 11.	PlusoptiX measurement process - white squares over pupils.....	25
Figure 12.	PlusoptiX measurement process - green circles indicating a correct testing distance .....	26
Figure 13.	PlusoptiX screenshot of a successful measurement.....	27
Figure 14.	Save video button .....	28
Figure 15.	Areas of interest for plusoptiX measurement troubleshooting .....	34
Figure 16.	Incorrect (top) and correct (bottom) covering of the eye using the palm of the hand. ....	36
Figure 17.	Assessment with the Frisby stereotest .....	38
Figure 18.	Testing with the Frisby stereotest.....	39
Figure 20.	Reichert AL-200 Focimeter .....	49
Figure 21.	Focimeter screen with right lens measurement selected .....	50
Figure 22.	Focimeter with glasses in place to measure the right lens .....	51
Figure 23.	Focimeter screen during lens measurement.....	51
Figure 24.	Focimeter screen with correct lens placement .....	52

## 1 Background

Initial discussions regarding vision assessments took place in 2012, in the Life Study Scientific Protocol Development Group and Scientific Working Groups. Consideration was given to potential research questions that could be answered by Life Study, and also the exciting opportunities for novel approaches to be included.

Work to develop the Life Study Standard Operating Procedures (SOPs) commenced in 2013, prior to the initial Life Study pilot for the pregnancy component. NatCen Social Research conducted this pilot and their staff were involved in the initial development of the SOPs.

Members of the Life Study Neurodevelopment Group provided in-depth scientific expertise from a range of complementary disciplines. They reviewed the results from the Life Study pilot and advised on the neurodevelopment assessments to be included in the final Life Study scientific protocol.

The Life Study Scientific Steering Committee reviewed recommendations from the Neurodevelopment Group and had overall responsibility for the final Life Study scientific protocol.

Members of the Life Study team based at UCL Institute of Child Health gave feedback on draft documents, sourced equipment, tested data capture mechanisms and liaised with external suppliers regarding the specification and development of data capture systems.

Staff in the first Life Study Centre based in the Barking Havering and Redbridge University Hospitals NHS Trust, gave feedback on their experiences in conducting these measurements with participants. This feedback was incorporated in subsequent versions of the SOPs.

The Adult Eyes and Vision Assessment SOPs presented in this document were those in use when the Study was closed in October 2015.

## 2 Aim

In the first phase of Life Study we are investigating:

- How vision develops in infants
- How and why misalignment of the eyes (strabismus) – commonly known as a ‘squint’ or ‘turn’ - develops in children
- The relationship between vision and specific eye conditions and physical, social and emotional development.

To do this, we need to measure - through assessments -

- the alignment of the eyes (strabismus)
- the presence or absence of short sightedness or long sightedness (refractive error)
- the presence or absence of depth/3D vision (stereovision).

We also need to collect information about eyes and vision through the Life Study questionnaire instruments. The information collected from these assessments and questionnaires is not equivalent to a clinical assessment and therefore cannot be used to advise participants on the need for any further detailed medical review. Thus no feedback on the findings of the ‘Eyes and Vision’ assessment will be provided to participants<sup>1</sup> in line with the Life Study Ethics and Information Governance Framework<sup>2</sup>.

## 3 Subjects

### 3.1 Inclusion criteria

Mothers who have given consent and are attending the Life Study pregnancy visit.

Partners who have given consent and are attending the Life Study pregnancy / partner visit.

### 3.2 Exclusion criterion

Adults who have both eyes missing.

At the beginning of the assessment the participant should be asked if they have one or both eyes missing (for any reason). Those with both eyes missing will not have any assessments. Those with one eye missing will be tested with the unocular protocol for the plusoptiX and the rest of the protocol is unchanged.

---

<sup>1</sup> ‘Participant’ refers to the infant and to his/her mother or individual with legal parental responsibility for the infant, and/or the mother’s nominated father or partner who may or may not have legal parental responsibility for the infant.

<sup>2</sup> This can be accessed through the resources pages on the Life Study website [www.lifestudy.ac.uk](http://www.lifestudy.ac.uk)

## 4 Staff undertaking the assessment

Staff are trained in using the plusoptiX A09, Frisby stereotest, autofocimeter and digital camera by a research orthoptist and/or plusoptiX technician.

## 5 Environment

- Room lighting should be dim but not completely dark for the plusoptiX measurement at the beginning of the protocol.

### **NOTE:**

- Windows need to be covered to avoid UV light interference with the plusoptiX autorefractor (see 6.1).
- All other assessments are conducted under standard office illumination.

## 6 Equipment

### 6.1 PlusoptiX A09 Autorefractor

The plusoptiX autorefractor (Figure 1) is a device that is used in clinical settings in order to rapidly assess the alignment of the eyes (presence or absence of a squint) and short or long sightedness, with a view to deciding if a subject needs to be referred for detailed expert clinical review.

The plusoptiX has a default 'binocular' setting (which will be used for >95% participants), which works by measuring both eyes at the same time. Thus it requires two 'normal' eyes which are reasonably well aligned.

It will be uncommon for a participant to have widely misaligned eyes and very rare for a participant to have one malformed, missing or artificial (prosthetic) eye. In these situations, the device is used in the 'uniocular' (one eye) setting so that it can measure each eye separately. This is described later.



*Figure 1. PlusoptiX A09 autorefractor*

The device has a 'vision screener' unit, comprised of a base with a cradle, and the hand-held device 'head'.

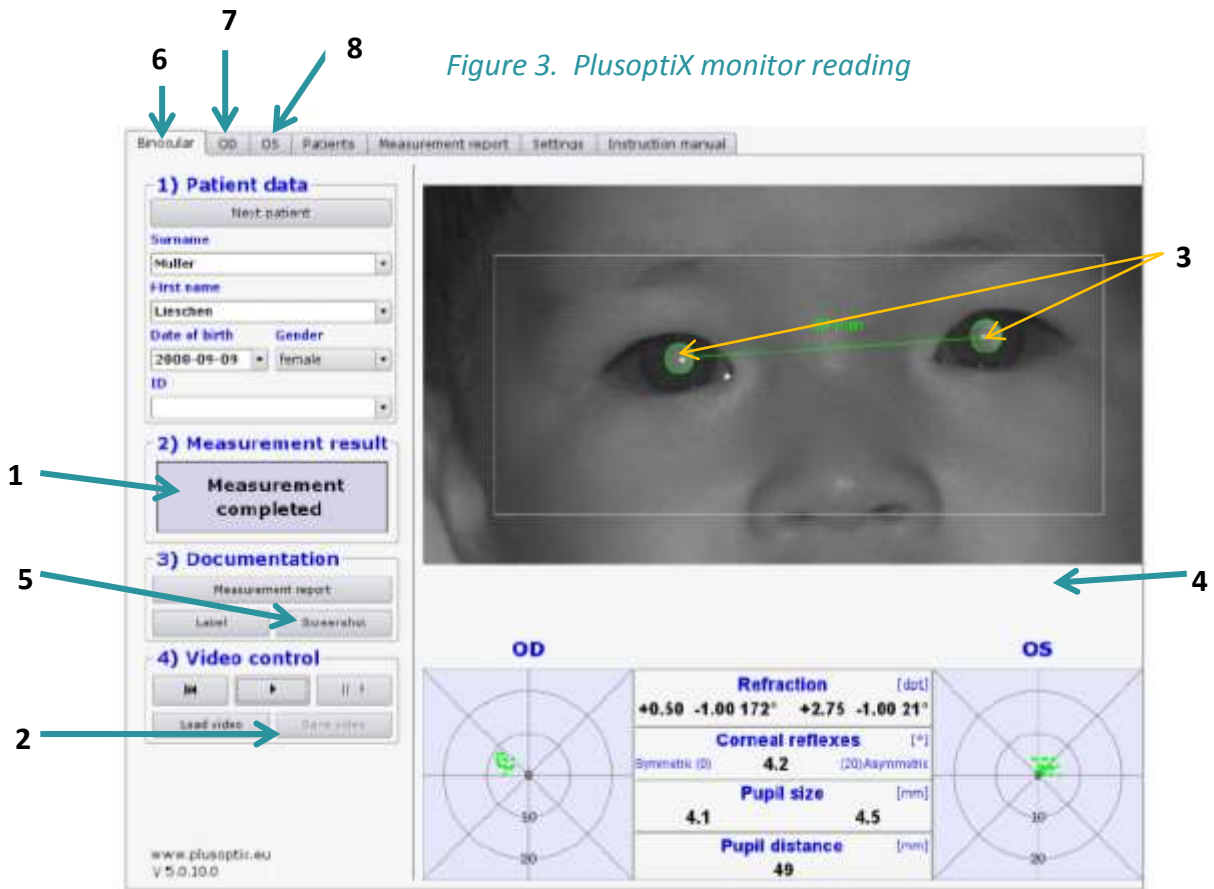
It is a non-invasive, non-contact device. The participant simply views small red lights on the "nose" of the face on the device head held by the examiner (Figure 2).



*Figure 2. PlusoptiX autorefractor device head*

The monitor displays the participant's face (eye area), seen in Figure 3, and the measurement is made by the device held by the examiner.





<http://www.plusoptix.com/>

## Key

- 1 Measurement result
- 2 Save video button
- 3 Pupil circles (green/red)
- 4 Information bar (only present when error messages appear)
- 5 Screenshot capture button
- 6 'Binocular' tab – Default test mode
- 7 'OD' tab – For testing the right eye
- 8 'OS' tab – For testing the left eye

## 6.2 Frisby Stereotest.

The Frisby Stereotest is used to measure depth perception (stereovision or 3D vision), which requires reasonably good vision in each eye and the ability to use the eyes together.

The test contains 2 plates in a box with a flip down lid which provides a white background in front of which the plates are held for the test (Figure 4). **NOTE:** The thinnest plate has been permanently removed from the box to simplify the test procedure, leaving two plates.

Plate number 1 (the thicker plate) is marked with a white sticker; plate number 2 is marked with a red sticker (Figure 5). Each of the plates is made up of two clear sheets held together by round studs at each corner.

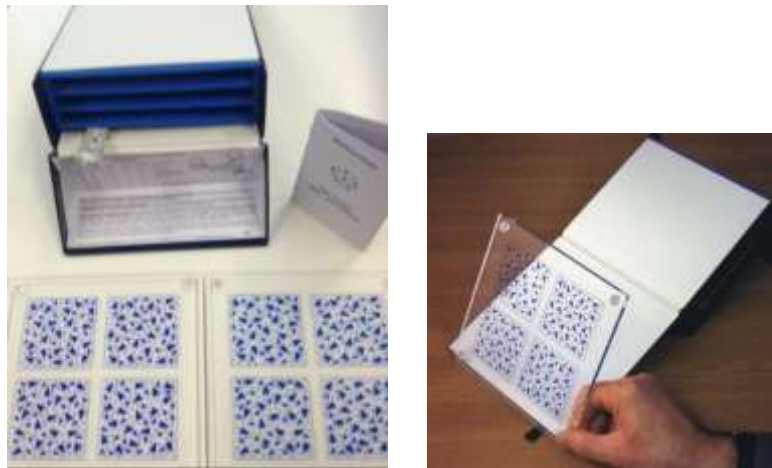


Figure 4. Frisby stereotest plate with four images



Figure 5. Frisby plate with white and red sticker identifiers

Each plate is divided into quarters. Each quarter has a printed image made up of randomly orientated 'arrowheads' of different sizes (Figure 4). Frisby stereotest plate with four images).

**ONE** of the four images on the plate has inside it a ‘Hidden Target’, which appears to protrude forwards from the background. It can only be seen using depth perception/3D vision (Figure 6).



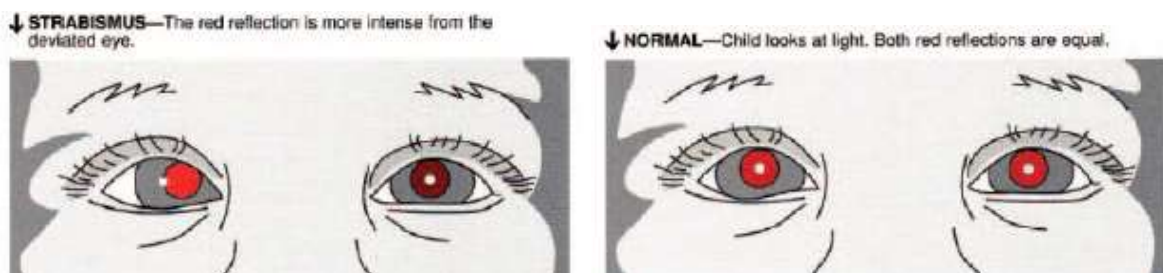
[www.frisbystereotest.co.uk/](http://www.frisbystereotest.co.uk/)

*Figure 6. Hidden target in one image on plate*

**NOTE:** The image with the target within it is next to the corner of the plate with the stud that has been filed flat. The coloured sticker that identifies the plate is located on the corner next to the hidden target. It should therefore always be covered from the participant’s view by the examiner’s hand (Figure 4), but will allow for easy identification of a correct response.

### 6.3 Digital camera

This is used to take a photograph of the eyes (mid face area) of all participants in whom each eye had to be tested separately with the plusoptiX device and when a participant required their eyelids to be lifted to complete an assessment. The photograph will be used to assess alignment of the eyes using the ‘red eye’ image that appears in a photograph when a flash is used (Figure 7).



*Pediatrics 2008;122;1401*

*Figure 7. Image composition for mid-face photograph*

6.3.1 Camera Settings

**NOTE: These should be as follows:**

Auto-focus: ON      Red-eye reduction: OFF      Flash: ON      Mode: P



Red Eye reduction control is accessed through the menu: Select **OFF**

Image review button



Flash on/off button: Select **ON**

Mode dial: Select **Mode P**



Zoom Barrel

[www.canon.co.uk](http://www.canon.co.uk)

Figure 8. Digital camera

#### 6.4 Auto Focimeter

This device measures the strength (prescription) of lenses in a pair of glasses. All participants who wear glasses will have them measured as the last part of the assessment.



[www.reichert.com](http://www.reichert.com)

*Figure 9. Reichert AL-200 Autofocimeter*

## 7 Preparation

- 1) **NOTE: Room lighting is very important and different lighting is required for the different parts of the assessment.**

Throughout the day during all testing, all windows should be covered to avoid UV light interference with the plusoptiX device. The participant will enter the room while it is dimly lit. The room lighting needs to be dim, but not completely dark for the plusoptiX measurement at the beginning of the protocol and restored to normal 'office' levels for the Frisby Stereotest and for photography.

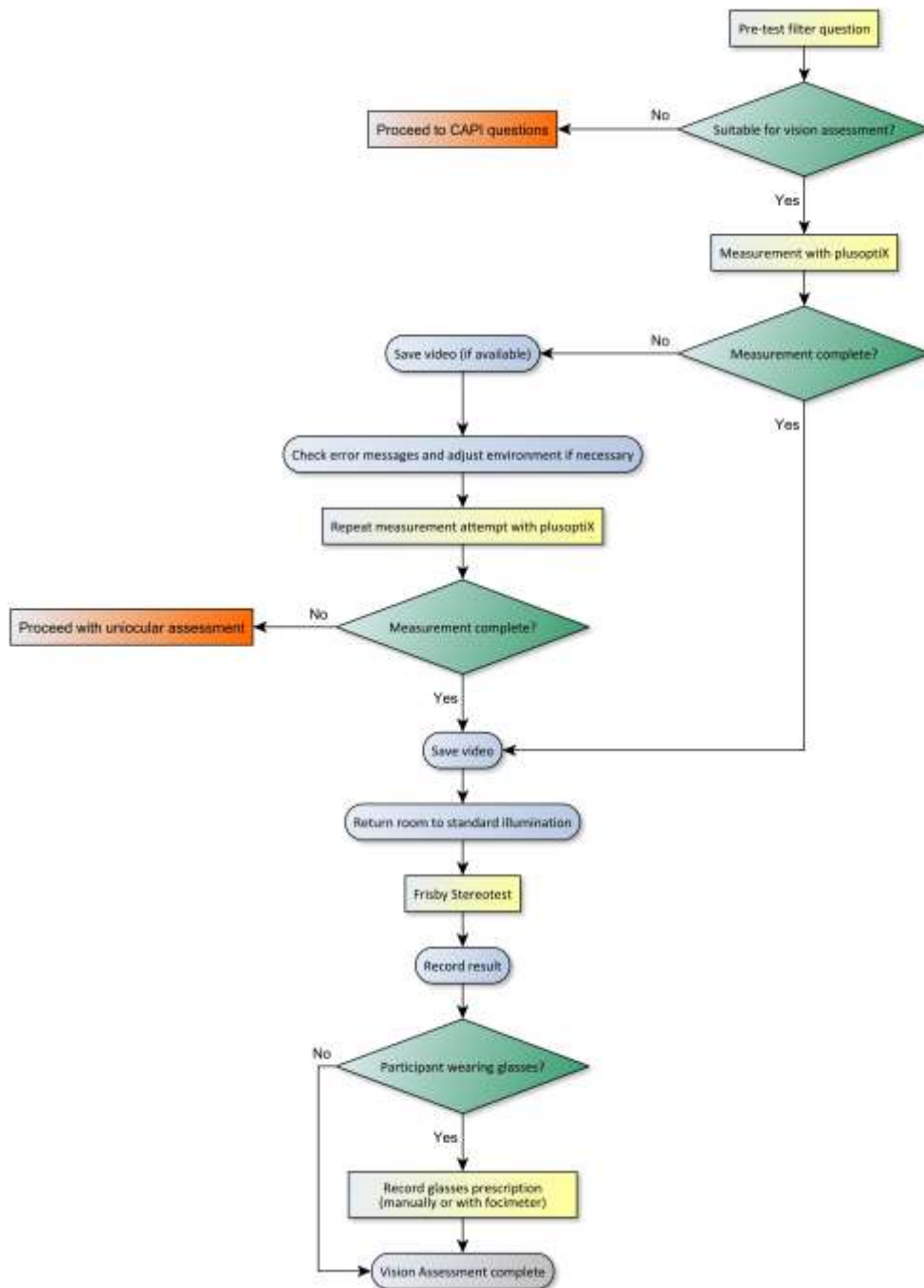
- 2) The plusoptiX device and monitor are set at a workstation, 1.5 metres from the chair for the participant (Figure 0).
- 3) The plusoptiX device, monitor, focimeter and workstation computer (for data capture) must be **TURNUED ON** at the **START** of the day and left on throughout the day.
- 4) The Frisby stereotest and digital camera should be ready near the workstation.
- 5) **To turn on the plusoptiX device:**
  - a) Before turning on the plusoptiX device make sure the dongles from the back of the keyboard and the mouse have been inserted into the back of the plusoptiX device. The USB dongle for the mouse can be located by lifting the front part of the mouse where the batteries are stored.
  - b) Turn the monitor on first and then switch the plusoptiX on by pressing the black switch on top of the device.
  - c) Wait for the plusoptiX to load. Once the mouse is functioning, it is ready to use.
  - d) The USB memory stick to be used for video data capture must **ONLY BE INSERTED** into the plusoptiX vision screener base **AFTER** the device is switched on.
- 6) **To turn on the focimeter** - Press the black switch at the back of the focimeter.



*Figure 10. PlusoptiX assessment setup*

## 8 Summary of protocol

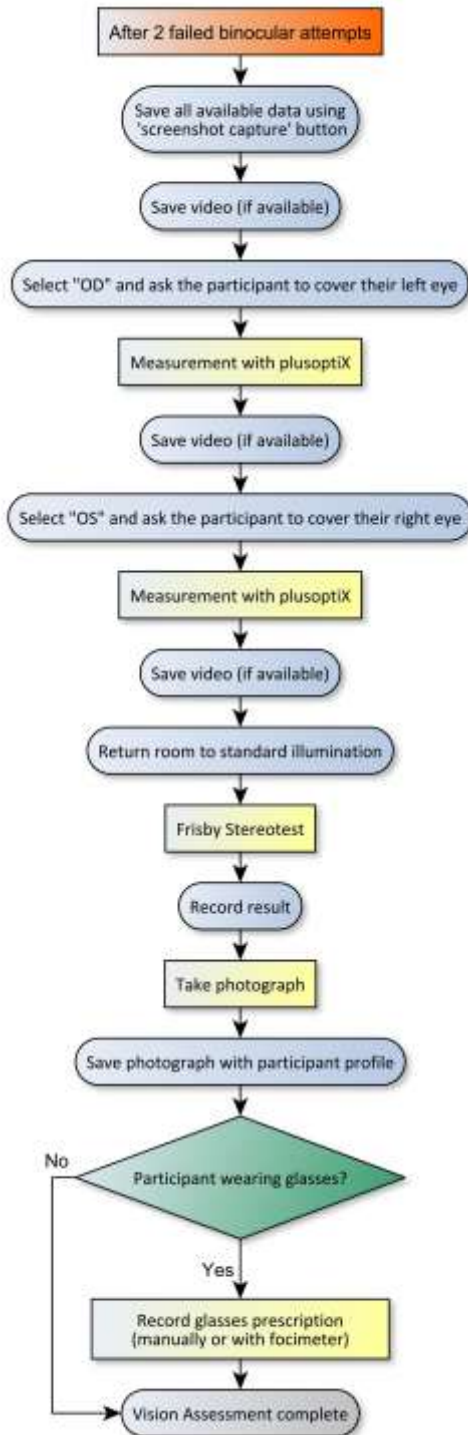
The eyes/vision assessment workflow of the conventional / default assessment protocol applies to the majority of participants including those who wear glasses (rather than contact lenses; see **Flowchart 1**).



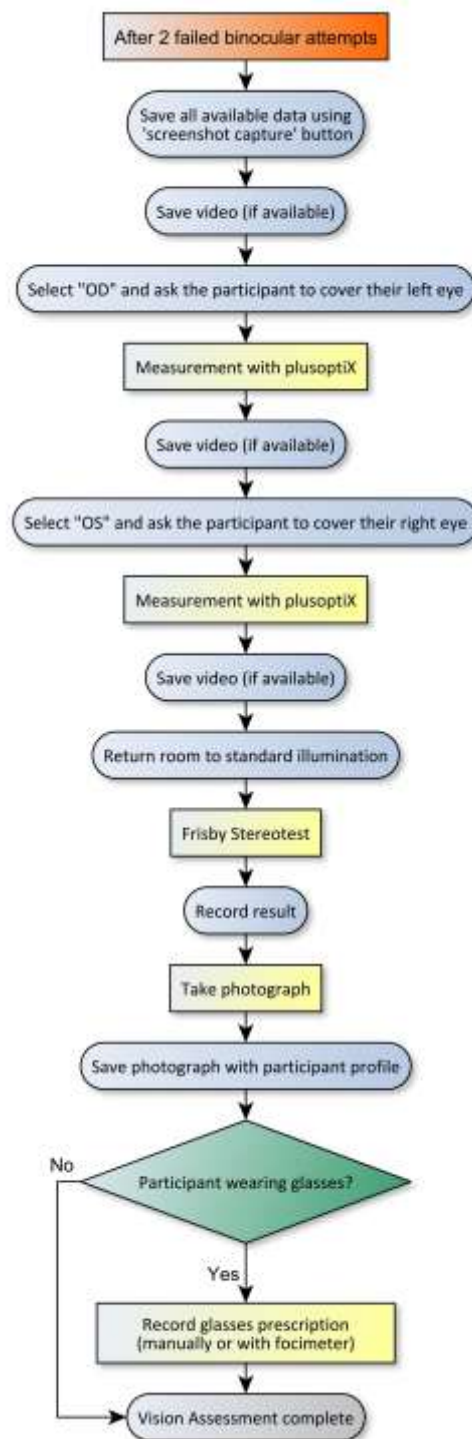
Flowchart 1 Vision assessment protocol overview



**NOTE:** In a minority of participants, it may be necessary to follow the alternative uniocular protocol,



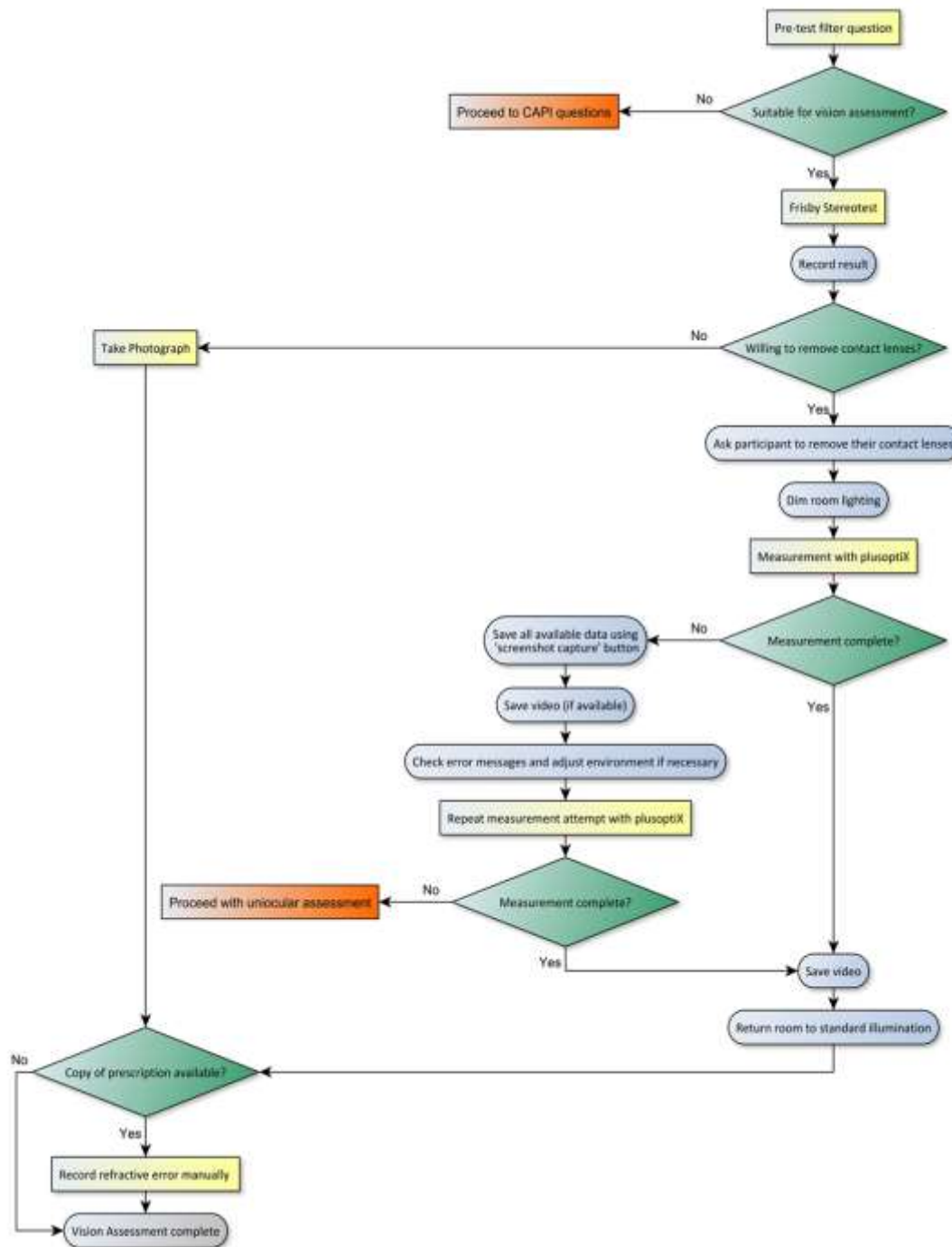
as set out in  
**Flowchart 2.**



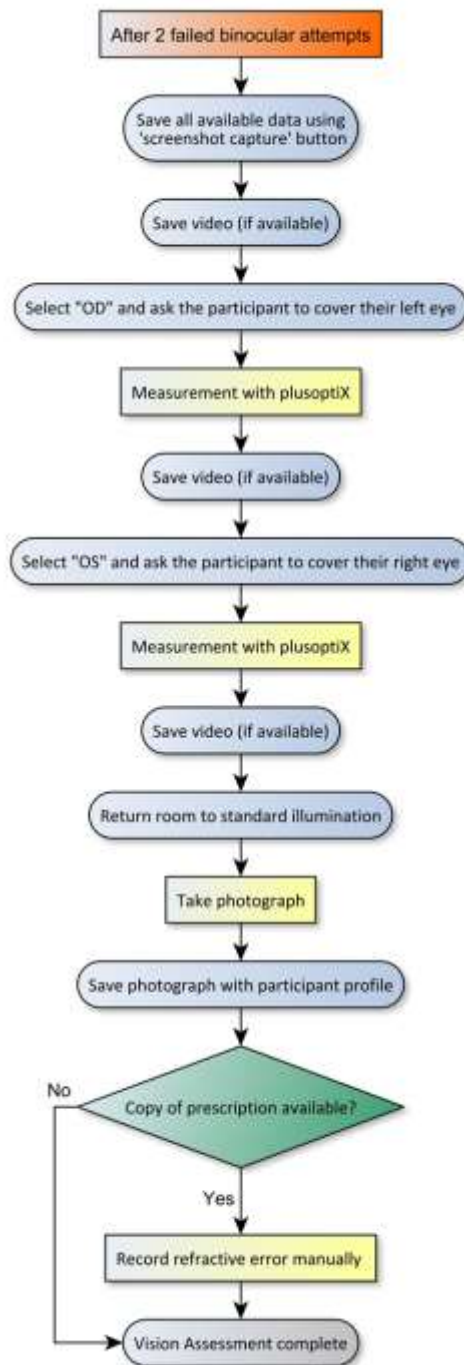
*Flowchart 2 Uniocular protocol for adults failing plusoptiX measurement with both eyes*

Flowchart 3 (below) shows the eyes/vision assessment workflow for adults wearing contact lenses at the vision assessment. NOTE: The procedures are identical to the standard

protocol, BUT THE ORDER OF TESTING IS DIFFERENT, to accommodate the removal of contact lenses.



Flowchart 3 Vision assessment overview for contact lens wearers



*Flowchart 4 Vision assessment overview for contact lens wearers failing plusoptix measurement with both eyes*

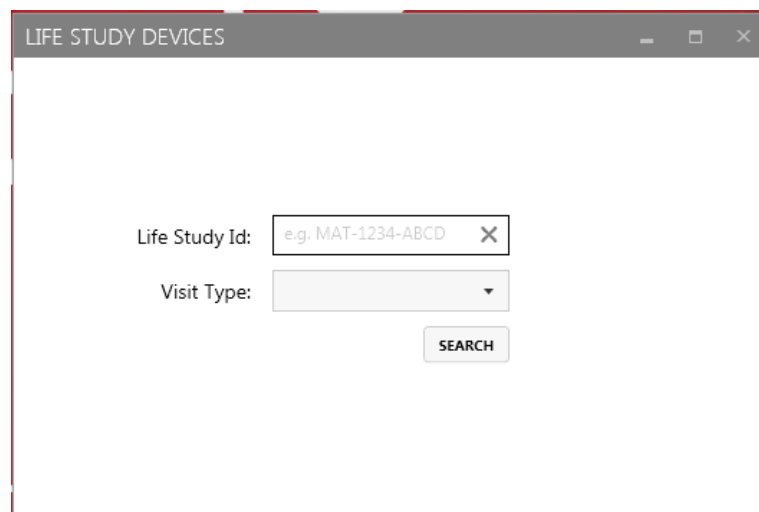
## 9 Measurement using the plusoptiX device

(see Flowchart 5)

- 1 The participant enters the examination room.
- 2 Open the “Pregnancy Visit Adult Vision Assessment Survey” via the UCL Life Study Survey Portal login.
- 3 Make sure that the Desktop Device Application is running. To do this click on the shortcut as shown below:



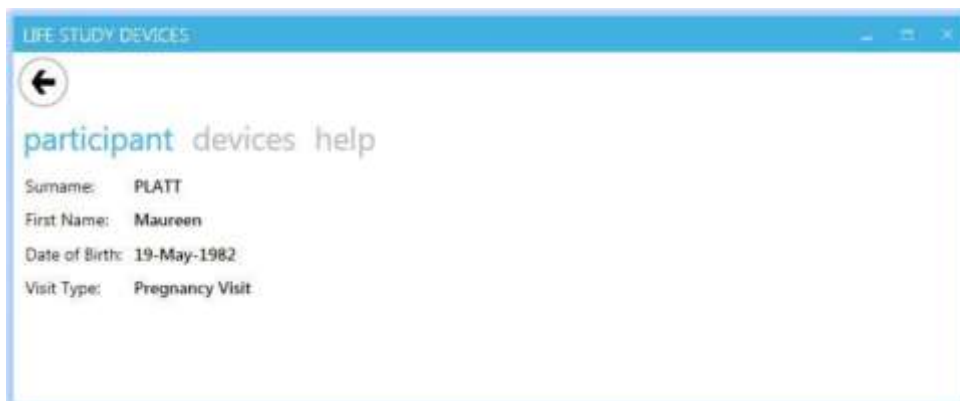
- 4 Enter the participant’s ID and select the visit type (Pregnancy Visit) using the dropdown box, then press “search”.

A screenshot of a web application window titled "LIFE STUDY DEVICES". The window contains a search form with two input fields: "Life Study Id:" with a text input containing "e.g. MAT-1234-ABCD" and a clear button (X), and "Visit Type:" with a dropdown menu. Below these fields is a "SEARCH" button.

- 5 The participant’s details (name, date of birth, gender, and visit type) should appear on the screen. Check this is the correct participant. If not, use the arrow in the top

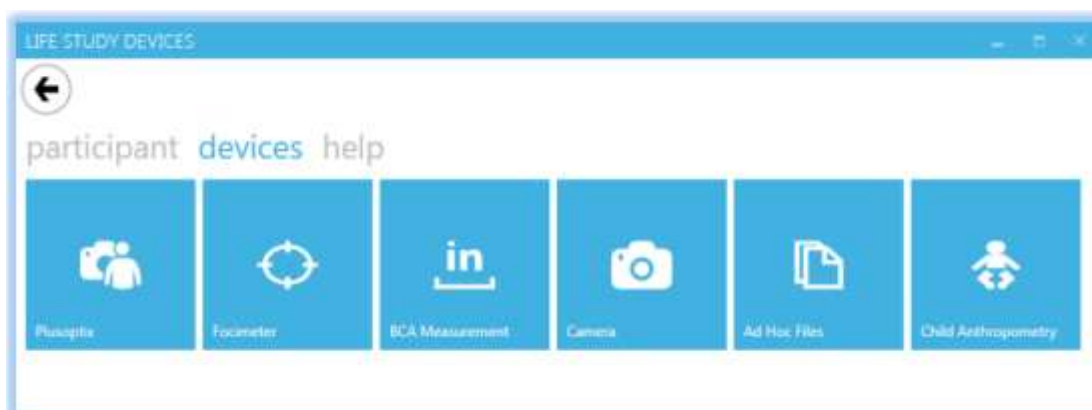
left corner to return to the participant identification screen and re-enter the correct participant ID.

3



6 Select “devices” which appears above the participant details.

7 Select “Plusoptix”.

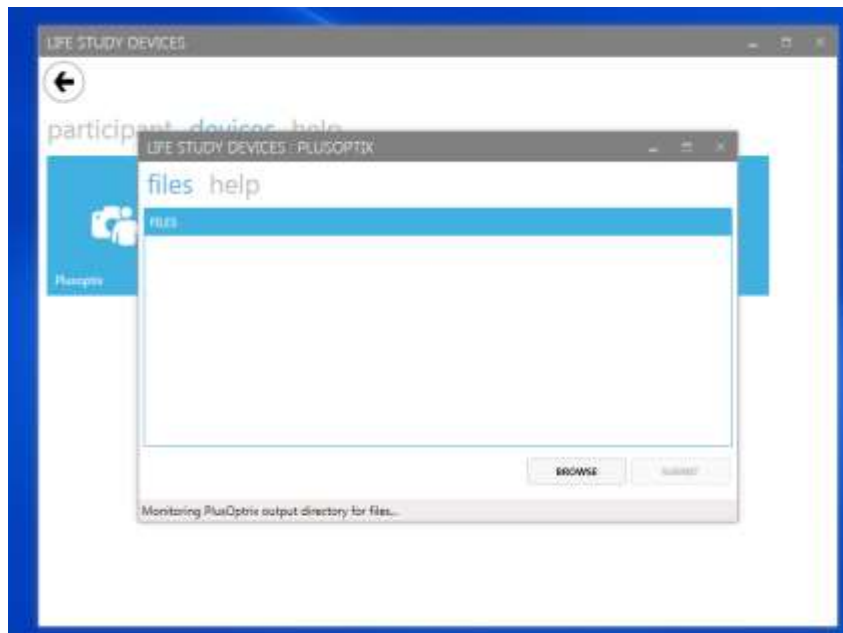


8 Upon launching the Plusoptix module the application will generate a configuration file specific to the current participant and interact with the plusoptiX software to configure your environment for a new set of measurements to be taken. You may need to wait for a few seconds for the configuration step to complete.

---

<sup>3</sup> Note – all names and dates of birth relate to fictitious participants

9 Once ready the application will display the following screen:



10 This screen indicates that the output measurements from the device are awaited. The application monitors the destination directory for the files created after the reading has been taken. When the measurements have been taken, the relevant files should appear in the files list under the files tab.

11 Commence the Vision Assessment Survey and follow the questions and instructions which appear on the screen. These will verify eligibility and consent, and prepare the participant for the plusoptiX measurement.

**If the participant has both eyes missing**

- **do not proceed with the vision assessment.** Record this in the Vision Assessment Survey.

**If the participant has one eye missing (confirmed by the pre-test filter question)**

- **switch the plusoptiX to the unocular (one eye) mode** and test the eye that is present (as described in [Section 9.2.2](#))
- **These participants will require a photograph** at the end of the assessment (see Section 11).

**If the participant is unsure as to whether one or both eyes are 'normal'**

- proceed with the standard protocol.

- 12 Briefly explain the procedure to the participant. They will be informed that:
- The device measures long / short-sightedness and the alignment of the eyes
  - There is no direct contact
  - There are no harmful risks

- 13 Face the participant and the plusoptiX monitor.  
The participant should sit facing forwards / towards you (Figure ).

- 14 Ask the participant to remove the participant's glasses, if worn.  
**NOTE:** The participant will need to put the glasses on again for assessment of stereovision (Frisby)

**For those wearing contact lenses, follow the order of testing as shown in Flowchart 3.**

Thus, for contact lens wearers, the plusoptiX measurement should be the last measurement and contact lenses are to be removed at this stage.

- 15 Lift the plusoptiX autorefractor device head off the cradle and **make sure the room is dimly lit.**
- 16 Sit on a wheeled office chair and hold the device head at eye-level to the participant (Figure ).
- 17 Hold the handle with one hand, placing a finger over the trigger. Place the other hand above or below the body of the device to stabilise.
- 18 Hold the device head 1.25 metres from the participant's face.
- 19 Measurement can start when the "trigger" on the device head is pulled.  
**NOTE:** Once a measurement is complete, pulling the 'trigger' again **RESETS** the device and **DELETES ANY UNSAVED INFORMATION.**
- 20 Pulling the 'trigger' causes a sound to be emitted to attract the participant's attention.
- 21 Once the trigger is pulled, the screen will display what the device is 'viewing' in real time.



- 22 Move the device head until it is pointing directly at the participant's face, as shown in Figure .

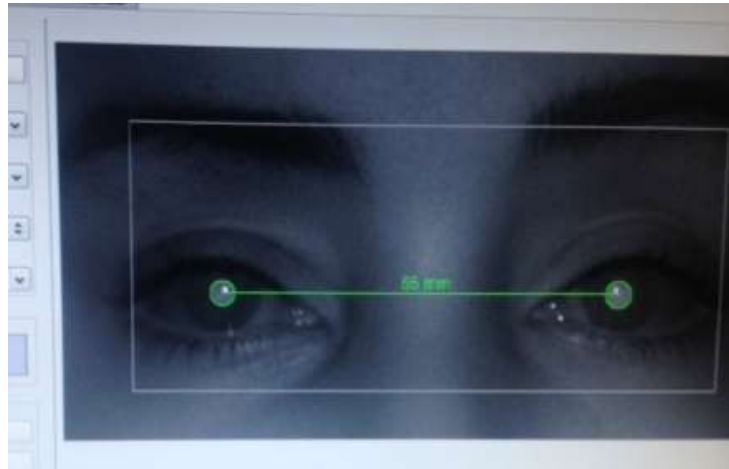
**NOTE:**

Initially, the image will be blurry, with white squares over the pupils (Figure ).



*Figure 11. PlusoptiX measurement process - white squares over pupils*

- 23 Move the device head closer to the participant. The image will become clearer as you move closer. Stop moving when the white squares are replaced by green circles over the pupils (Figure ).



*Figure 12. Plusoptix measurement process - green circles indicating a correct testing distance*

- 24 If the green circles change to white squares again, move the device away from the participant very slowly until the green circles re-appear.
- 25 Measurement of both eyes simultaneously begins automatically once the green circles are present.
- 26 Measurement continues as long as the participant continues to look at the 'face' on device head.  
**NOTE:** Encourage the participant to maintain viewing.
- 27 On average, measurement takes about 5 seconds.
- 28 The device 'beeps' to indicate measurement is complete.
- 29 When measurement is complete (device has beeped), the measurement result (Label 1, Figure ) shows a "Measurement completed" message. This indicates a successful measurement.

See Section 9.2 for further discussion of possible outcomes and actions required if a successful measurement has not been made.

Figure 13. PlusoptiX screenshot of a successful measurement



Label 1: Measurement completed

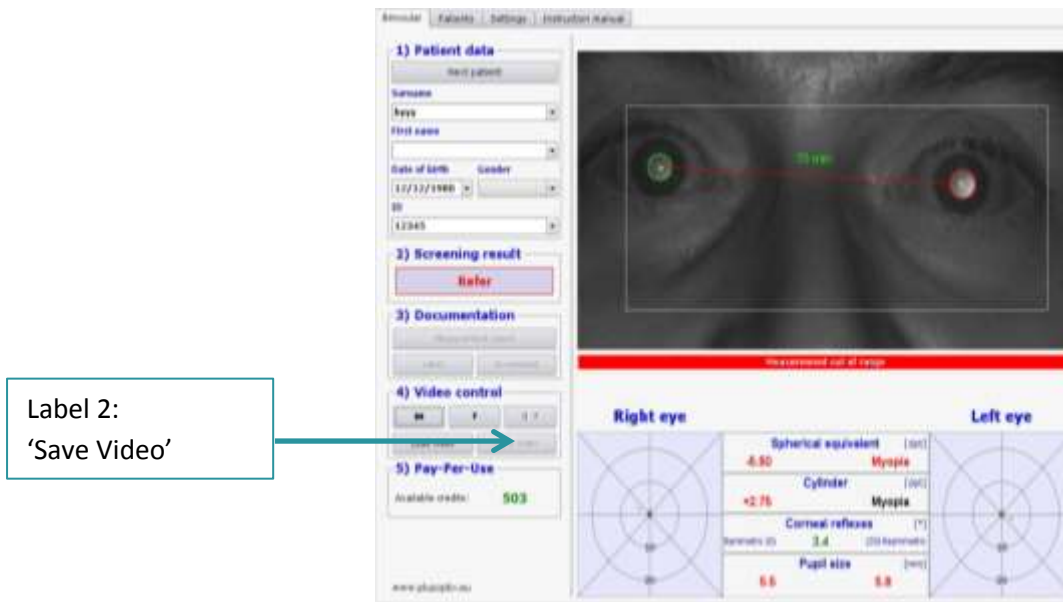
30 Press the “save video” button as shown in Figure to save measurement data. This saves the video to the USB stick in the back of the plusoptiX device.

**NOTE:**

Video data must be **SAVED** manually in this way.

**ANY UNSAVED DATA WILL BE LOST** if another measurement is made (trigger pulled).

Figure 14. Save video button

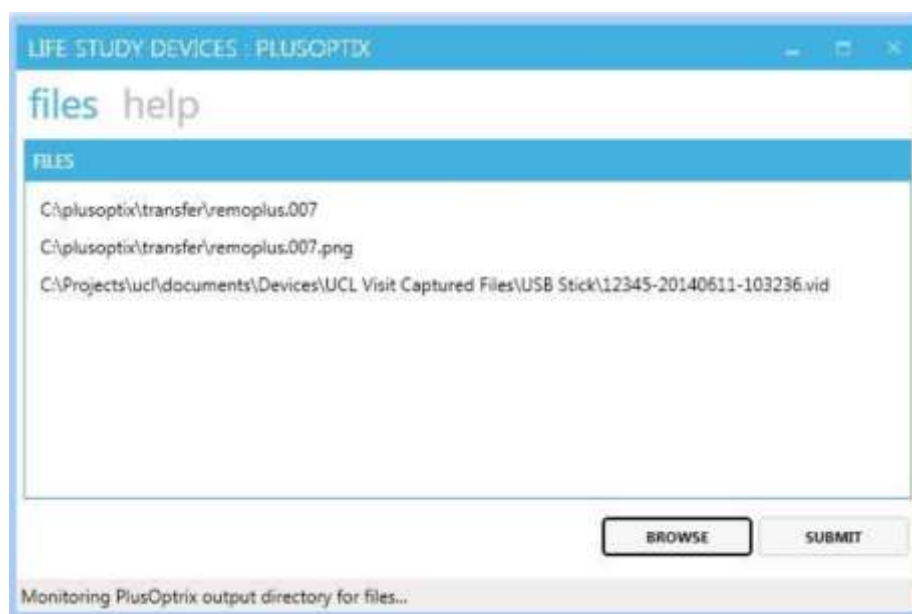


31 When the measurements have been taken, the files should appear in the files list within the Desktop Device Application as shown below:

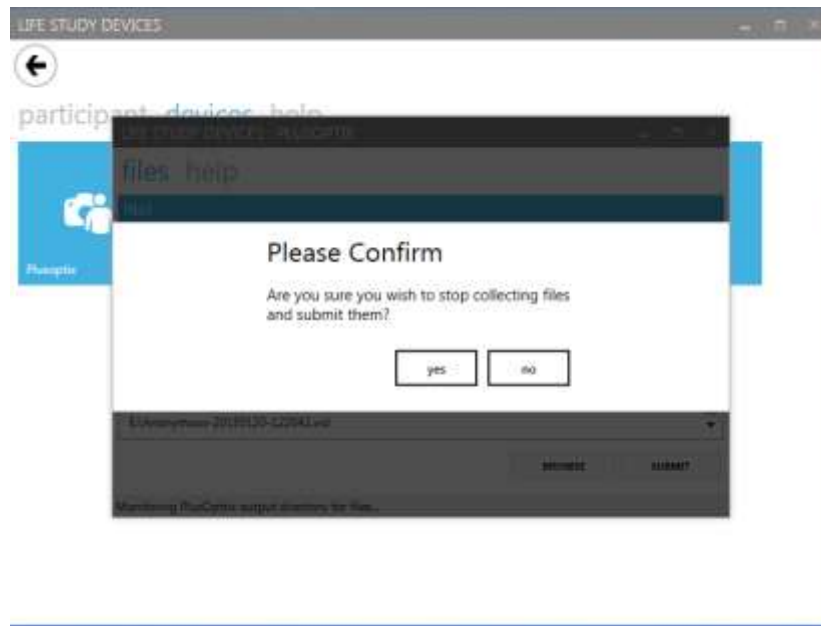


32 The application will continue to monitor for new files during this time. Once the system has found a file named remoplus.[nnn] then the SUBMIT button will be enabled; if the system does not automatically pick up the file from the monitored directory, browse to find the remoplus file and select it, and this will also enable the button.

- 33 Once all the files are present attach the video file from the USB storage device attached to the plusoptiX apparatus. Remove the USB stick from the back of the plusoptiX and place it in the USB port on the left side of the computer screen. Click the BROWSE button on the Desktop Device Application, and then select Local disk (E:) to access the files on the USB stick. Click on the .vid file (which should display the correct date and time) which will be added to the files list.

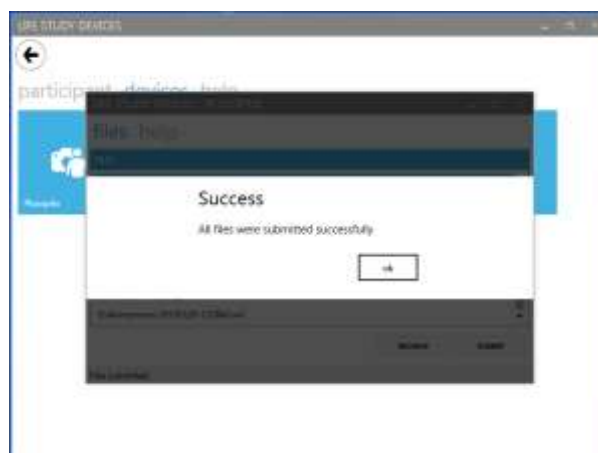


- 34 When all the relevant files have been collected, select the SUBMIT button, which will display a confirmation screen as follows:



- 35 If 'no' is selected, the previous screen is shown and more files can be added. If 'yes' is selected, the files will be copied to long-term storage and then removed from local storage on the plusoptiX device (and the local computer if relevant).

- 36 A confirmation screen will be displayed confirming that all files have been submitted successfully.



- 37 On selecting 'OK' the PlusoptiX module will end and you are returned to the devices selection screen

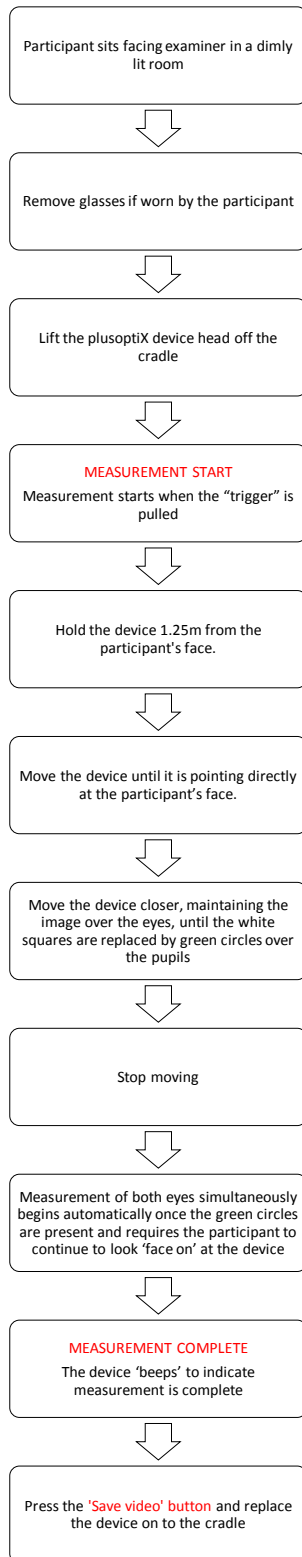
- 38 Restore the room to standard office illumination levels.
- 39 Complete the Vision Assessment Survey.
- 40 Check that the data have been deleted from the USB Stick. Eject and remove the USB stick from the side of the computer screen and place it back in the plusoptiX device so that it is ready for the next participant.
- 41 If at any time you find data left on the USB stick from another participant, you should notify the Life Study Centre Manager.
- 42 If there is a folder on the USB stick called “PDF”, this is because the “Screenshot” button on the plusoptiX was pressed in addition to, or as well as the “Save video” button.
- 43 Assuming that the protocol was followed and three files have been transferred via the Desktop Device Application, then this “PDF” folder can be deleted (as the screenshot will already have been saved).
- 44 Delete the “PDF” folder from the USB stick.
- 45 Check the recycle bin, and if it has been transferred to there, delete it from the recycle bin as well.
- 46 Finally, once all data have been submitted, remove the participant’s image and data from the plusoptiX screen by clicking “next patient”.

## 9.1 PlusoptiX Top Tips

Always make sure the participant is:

- Directly ‘face on’ and not moving / looking to the side
- Not looking up or down to see the device head

If the participant is not facing directly forwards or turns their face then the plusoptiX screen will show one green and one red circle over the pupils or it will struggle to find the pupils at all. It will not be able to take a measurement.



- The device makes a sound to attract the participant's attention
- An image of what the device is 'viewing' will show on the monitor
- One hand should hold the handle, with a finger over the 'trigger'. The other hand can either be placed below or on top of the device to aid stability
- If required, the trigger can be pulled again to attract the participant's attention or other sounds can be used before measurement begins
- Initially, the image will be blurry, with white squares over the pupils
- The image will become clearer as you move closer
- If the circles turn to white squares again, move the device backwards slowly until the green circles re-appear
- **NB. An Information Bar label 'Measurement out of range' is a 'successful' measurement and does not need to be repeated.**

*Flowchart 5. PlusoptiX measurement process*



## 9.2 Troubleshooting measurements using the plusoptiX device

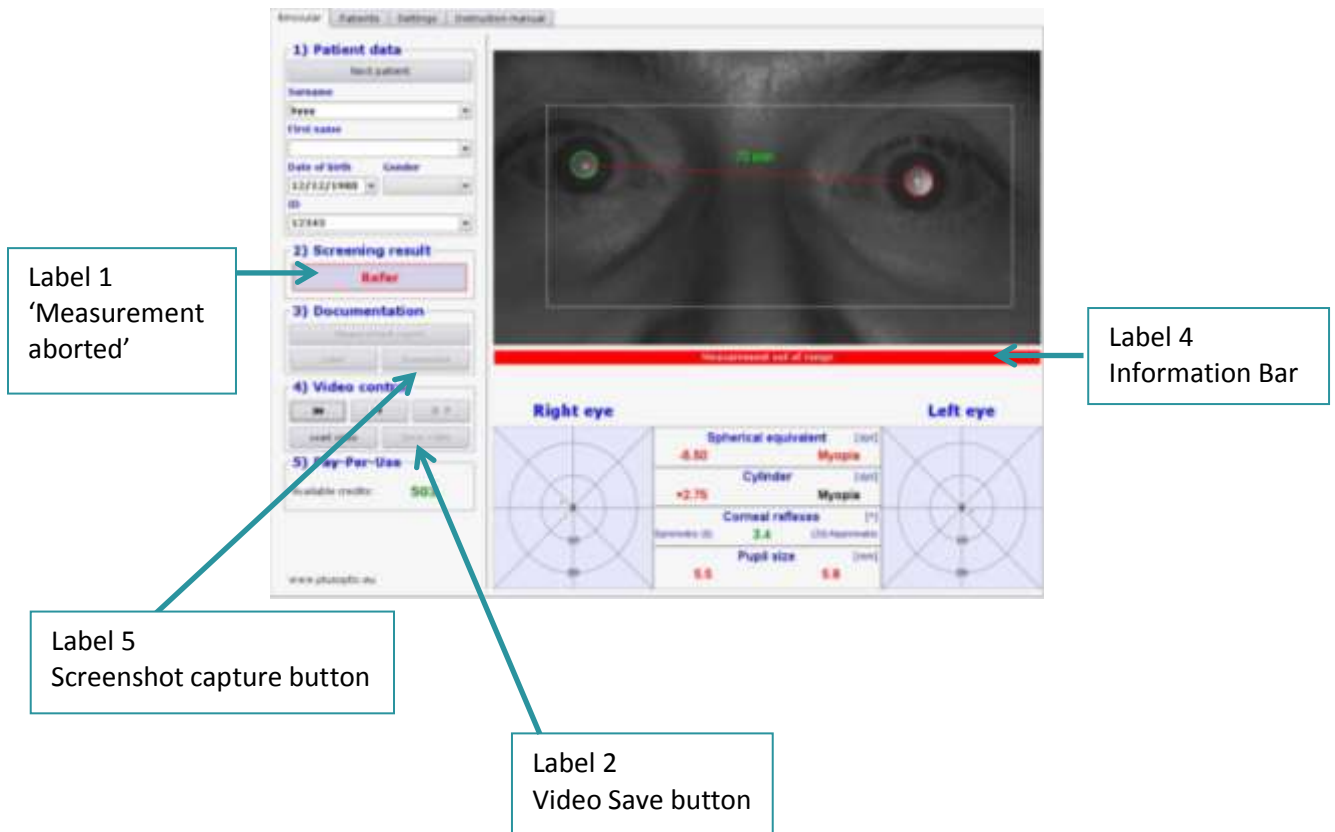
### 9.2.1 Outcomes of a plusoptiX measurement

- Table 1 lists all possible outcomes of a plusoptiX measurement: different plusoptiX outcomes change the testing process that follows.
- Successful measurements (measurement result = ‘completed’) do not require a further measurement attempt.
- For certain plusoptiX outcomes you will need to troubleshoot.

First measurement outcome	‘Information bar’ comment	‘Measurement result’ comment	Action required	Photograph needed?
<b>Successful</b>	Nil	‘Measurement completed’	Save all available data (screenshot and video) (See flowchart 1) Move onto Frisby Stereotest	No
<b>Successful</b>	‘Measurement out of range’	‘Measurement completed’	Save all available data (screenshot and video) (See flowchart 1) Move onto Frisby Stereotest	No
<b>Unsuccessful</b>	‘Pupils not found’	‘Measurement aborted’	Save all available data (screenshot and video) Attempt another measurement Switch to UNIOcular testing setting and repeat measurement if second binocular attempt is unsuccessful Save all available data (screenshot and video) Move onto Frisby Stereotest	Yes
<b>Unsuccessful</b>	‘Pupils too large’	‘Measurement aborted’	Turn up room lighting – see troubleshooting guide and try measurement again Save all available data (screenshot and video) Move onto Frisby Stereotest	No
<b>Unsuccessful</b>	‘Pupils too small’	‘Measurement aborted’	Turn down room lighting - see troubleshooting guide and try measurement again Save all available data (screenshot and video) Move onto Frisby Stereotest	No

Table 1 PlusoptiX outcomes and actions required

Figure 15. Areas of interest for plusoptiX measurement troubleshooting



A full description of the plusoptiX protocol and troubleshooting guidance (with alternative protocols) is given below.

### 9.2.2 Key Points

- 1 If the participant is not 'face on' and looking directly at the device, the circle over the pupils will turn red and automatic measurement will not proceed. Ensure that the participant is directly 'face on' and at eye-level. Measurement will start as soon as both circles become green.
- 2 If measurement still does not occur, check the message in the "information bar" (Figure 15, label 4) and follow the steps in Table 2.
- 3 Note the following protocol if the information message reads '**pupils not found**'
  - a. If a pupil is partly obscured by the eyelid, ask the participant to lift their eyelid and then resume measurement.  
**NOTE:** A note of which eyelid was raised must be documented in the Vision Assessment Survey and these participants will also have a photograph (see Section 11).
  - b. If you have tried to re-engage the participant but there continues to be a measurement failure (information bar still reads "**pupils not found**"), no data will be saved automatically. All data captured so far (in attempting the measurement) should be saved manually using the screenshot capture button (Figure 15, label 5) and video save button (Figure 15, label 2), as shown above.
  - c. **Switch the plusoptiX to 'uniocular mode'** by selecting the tab 'OD' at the top of the screen. This will allow measurement of the **RIGHT EYE** first.
  - d. Ask the participant to **COVER** their **LEFT EYE**. This should be done with the palm of the hand (Figure ).
  - e. Take a measurement with the device using the same technique as described above for binocular measurements.  
**NOTE:** If the device detects **TWO** pupils it will automatically stop taking a measurement.
  - f. Save the video by pressing the 'save video' button.
  - g. Select 'OS' from the tab and repeat the measurement process for the **LEFT EYE**. Ask the participant to **COVER the RIGHT EYE** for this measurement.

- h. A maximum two attempts should be made to capture a reading for each eye.
- i. Take a photo of the participant (see Section 11).

**NOTE:** The device takes longer to register a measurement if the corneal reflexes are asymmetrical. In these cases, the device will take a few seconds once the examiner is at the right distance. It is important to try to maintain the participant's attention to the device during this time. The device will not capture any data if the pupils cannot be found.

- 4 Take a photograph (Section 11) if a unocular measurement is required.
- 5 ***If no reading can be made with plusoptiX after two attempts*** (e.g. due to poor co-operation) record the reason in the Vision Assessment Survey. Then take a photograph as described in Section 11.



*Figure 16. Incorrect (top) and correct (bottom) covering of the eye using the palm of the hand.*

### 9.2.3 Troubleshooting ‘Environmental factors’

There are a number of ‘environmental factors’ that may make it difficult to obtain a measurement. A summary of these is set out in Table 2.

Information bar message	Actions
<b>Pupils too small</b>	Dim room lighting further and repeat measurement attempt
<b>Pupils too large</b>	Brighten room lighting and repeat measurement attempt
<b>Measurement out of range</b>	Continue with vision assessment. This is a ‘successful’ measurement
<b>Pupils not found</b>	<p>Prior to attempting a second measurement:</p> <p>Save all available data (screenshot and video)</p> <p>Check eyelids are not obscuring the pupils</p> <p>Ensure the participant is engaged with the task</p> <p>Repeat measurement attempt</p>
<b>Monocular: Cover OS!</b>	<p>This message only appears when the ‘OD’ tab is selected</p> <p>Ensure the left eye is properly covered</p> <p>Repeat measurement attempt</p>
<b>Monocular: Cover OD!</b>	<p>This message only appears when the ‘OS’ tab is selected</p> <p>Ensure the right eye is properly covered</p> <p>Repeat measurement attempt</p>

*Table 2. Troubleshooting for ‘environmental factors’ during the plusoptiX assessment*

**NOTE:**

- A maximum of two binocular measurements should be attempted.
- After this, unocular assessments will be conducted.
- Any participant requiring a unocular assessment will require a photograph at the end of the assessment.

## 10 Measurement with the Frisby stereotest

- 1 **Adjust the room lighting** to standard daytime office illumination levels.
- 2 The participant remains sat on their chair, as shown in Figure .



<http://www.frisbystereotest.co.uk>

Figure 17. Assessment with the Frisby stereotest

- 3 **If the participant wears glasses, ensure they are worn for this assessment.**
- 4 Familiarise the participant with the task by showing them what they are searching for i.e. the test image that sticks out towards them, as follows, before you start the test.

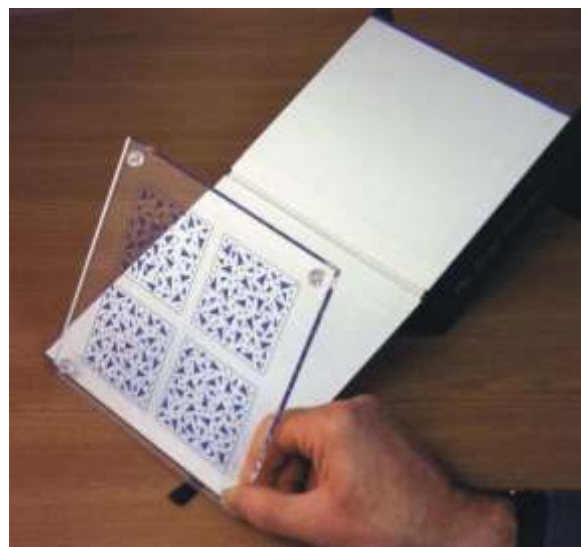
**Present plate 1** (the thickest plate – white sticker) in front of the white background of the box, holding it

- a. 30cm (12 inches) from participant's face  
AND
- b. with the hidden target in the **bottom** corner to your **right side** (target circle facing 'out').

**Point to the hidden target.** This will draw attention to the plate and show the participant what they are looking for.

- 5 **Flowchart 6** sets out the testing protocol. Record these responses in the Vision Assessment Survey.
- 6 **Present plate 1** (the thickest plate – white sticker) in front of the white background of the box, holding it
  - a. 30cm (12 inches) from participant’s face  
AND
  - b. with the hidden target in the **bottom** corner to your **left side** (target circle facing ‘out’).

**NOTE:** the image with the hidden target is next to corner of the plate that has been filed flat.



*Figure 18. Testing with the Frisby stereotest*

- 7 **Observe and score the test as either:**
  - a. ‘Positive’ response i.e. participant points to the correct location of the hidden target.
  - b. ‘Negative’ response i.e. participant either identifies the wrong location or is unable to detect the target.
- 8 **If response to plate 1 is positive**, move onto testing with plate 2 (see point 10).
- 9 **If response to plate 1 is negative**, re-test but after rotating the plate so that it is presented with the hidden target in the **top** corner to your **left side**.

**NOTE:** the image with the hidden target is next to corner of the plate that has been filed flat.

**a. Observe and score the test as either:**

- i. ‘Positive’ response i.e. participant points to the correct location of the hidden target.
- ii. ‘Negative’ response i.e. participant either identifies the wrong location or is unable to detect the target.

**b. If the second trial with plate 1 is negative,** then no further testing is required.

**c. If the second trial with plate 1 is positive,** then move on to testing with plate 2 (see point 10).

10 **Present plate 2** (the thinnest plate – red sticker) in front of the white background of the box

a. 30cm (12 inches) from participant’s face  
AND

b. with the hidden target in the **bottom** corner to your **right side** (target circle facing ‘out’).

**NOTE:** the image with the hidden target is next to corner of the plate that has been filed flat.

**c. Observe and score the test as either:**

- i. ‘Positive’ response i.e. participant points to the correct location of the hidden target.
- ii. ‘Negative’ response i.e. participant either identifies the wrong location or is unable to detect the target.

11 **If the response to plate 2 is positive,** then no further testing is required.

12 **If the response to plate 2 is negative,** re-test but after rotating the plate so that it is presented with the target in the **top** corner to your **left side**.

**NOTE:** the image with the target is next to corner of the plate that has been filed flat and is marked with a label. Always hold the plate with your **finger over the label**, so that the hidden target is presented facing outwards.



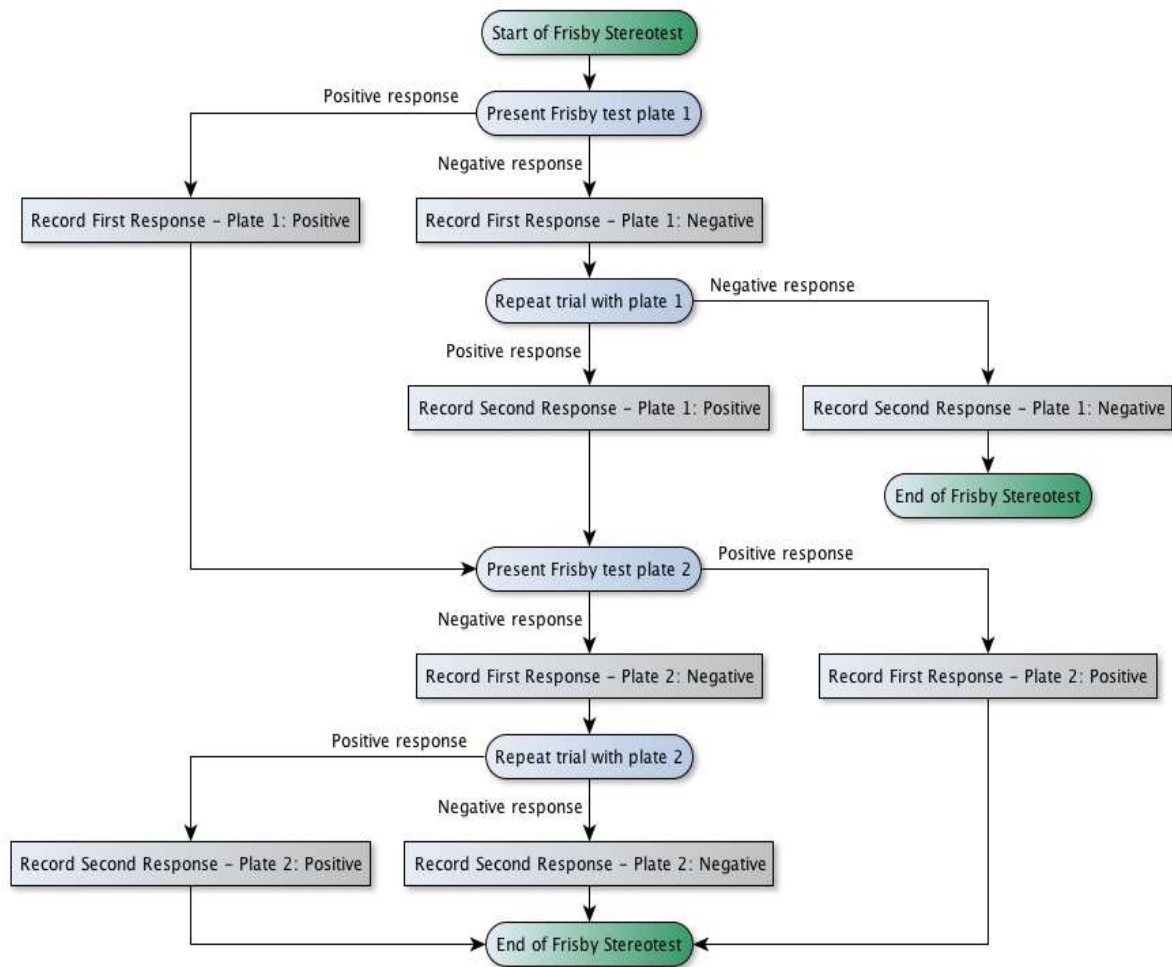
- a. **Observe and score the test as either:**
  - i. 'Positive' behavioural or visual response i.e. looking towards, pointing or touching the hidden target.
  - ii. 'Negative' response i.e. participant either identifies the wrong location or is unable to detect the target.

13 No further testing is required.

### 10.1 Frisby Stereotest Top Tips

Allow time for the participant to make a decision, but make sure they do not move their head once the plate has been presented.

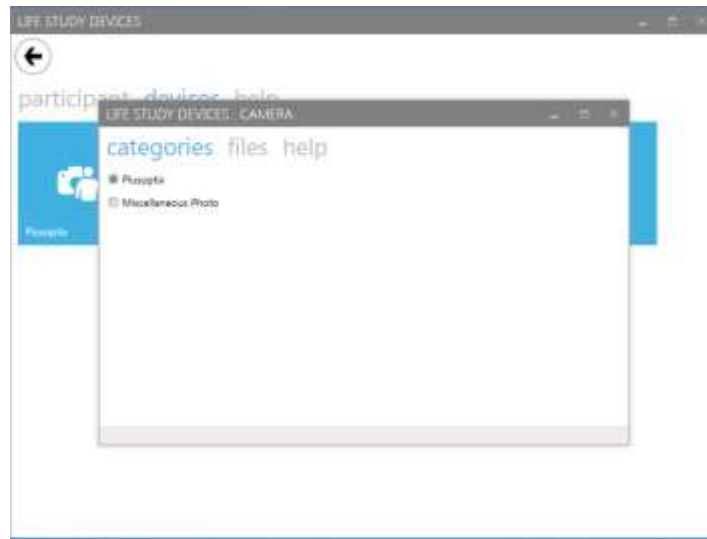
Ensure that the plate is held at 30 cm and that participants are wearing their reading glasses if required.



*Flowchart 6. Scores and outcomes for the Frisby Stereotest*

## 11 Photograph of the participant's eyes

- 1 **A photograph of the participants' eyes (mid face area) is required if any of the following occurred:**
  - a. One or both eyelids had to be lifted to allow plusoptiX measurement,
  - b. Uniocular testing was required,
  - c. Contact lenses were not removed to attempt a plusoptiX assessment.
  - d. A plusoptiX result was not obtained e.g. equipment failure, the participant refused the plusoptiX assessment
- 2 Keep the room lighting to standard daytime office illumination levels.
- 3 Explain to the participant that a photograph is needed because the plusoptiX device was not able to take a **FULL** measurement.
- 4 The participant remains seated on their chair.
- 5 Check that **CAMERA FLASH is ON, REDUCE RED EYE is OFF** and the **CAMERA MODE is set to P**.
- 6 Access the Desktop Device Application as before (if this has been closed) by entering the participant's ID number and check that the correct participant details appear. Select "Devices" and then "camera". Then select "Plusoptix" under categories. Select the correct category for the images so that they can be labelled accordingly as part of Life Study; the selected category can be found under the categories tab and also at the top of the file list on the files tab.



- 7 To return to the previous screen, press 'X' in the top right of the screen.

**NOTE:** If files have been added and the wrong category chosen, select the correct category before pressing the submit button: the category will change at the top of the file list and any selected files will still be present.

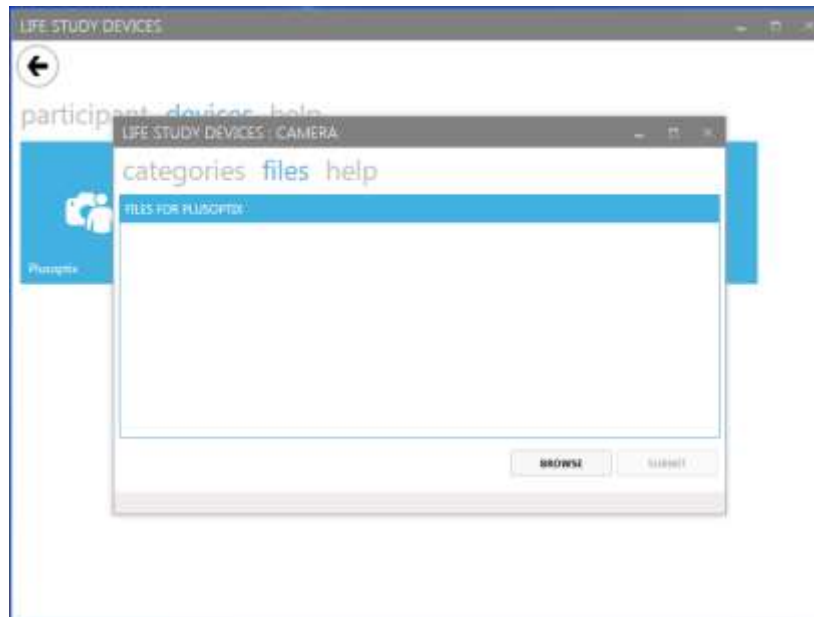
- 8 Once the correct category has been selected, click on the files link to switch to the files tab.
- 9 Take 'face on'/ 'face forwards' photograph(s) of the mid face area showing the eyes, as described below.
- 10 Take the camera and turn the lens barrel to 200mm. This will 'zoom-in' to allow a close-up photograph. Move your chair to approx. 2m from the participant.
- 11 Ask the participant to look directly at the camera lens.**
- 12 Look through the viewfinder. Half-pressing the shutter will make the camera focus. The camera will beep when focus has been achieved. Press the shutter down fully to take a photograph.  
**NOTE:** If the participant is too close, the camera will not focus.
- 13 If the participant moves after the camera has focussed, refocus by lifting your finger off the shutter and half-pressing it again. Take a photograph by fully depressing the shutter.

- 14 Review the image taken using the image review button. ***If the image is unsuitable (i.e. participant looking away from camera), re-take the image.*** A maximum of three attempts should be made.
- 15 Two photographs need to be taken of those being photographed because an eyelid was lifted during the plusoptiX assessment: one with eyelids in their natural position, and one with eyelids lifted (Figure ).

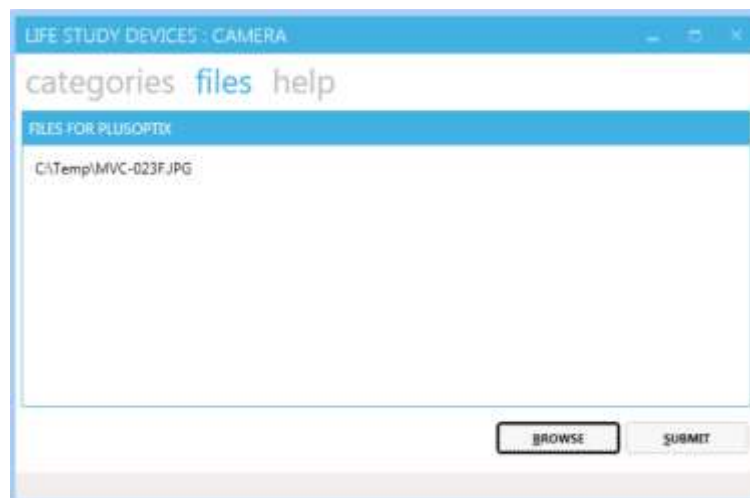


*Figure 19. Lifting an eyelid that obscures the pupil.*

- 16 Connect the camera to the PC via the USB cable.
- 17 Once the photo has been taken, return to the Desktop Device Application.



- 18 Click on the Browse button and select the appropriate files which will be added to the files list. (Computer / Cannon EOS 1100D / SD / DCIM / 108CDPFQ).



- 19 Once at least one file has been selected the SUBMIT button will be enabled. When all the relevant files have been collected, click on the SUBMIT button, which will display a confirmation screen as follows:



- 20 If “no” is selected, then the previous screen is shown and more files may be added. If “yes” is selected, files will be copied to long-term storage.
- 21 A confirmation screen will be displayed confirming that files have been successfully submitted.
- 22 Once the image has been successfully saved, go back to the camera, press view (to see the image on the screen) and then press delete.
- 23 Turn the camera off (and if necessary put the battery on charge).

### 11.1 Photography Top Tip

Ask the participant to blink a few seconds before you take a photograph to reduce the need to retake photographs.

## 12 Manual recording of refractive error

This section is only relevant for participants that wear glasses or contact lenses, and have brought a copy of the prescription with them to the assessment.

**If a copy of the glasses prescription is available**, record this in the Vision Assessment Survey (as shown below) using the example as a guide.

**If the participant is wearing glasses, but does not have a record of their prescription**, measure the strength of the glasses with the focimeter (see Section 13).

**NOTE: You must select the contact lens box, if the participant is wearing contact lenses AND brings a contact lens box with their prescription written on it. If the prescription is for spectacles, tick the 'Glasses' box.**

**Prescription type:**

Glasses

Contact lenses

	Sph (DS)	Cyl (DC)	Axis	ADD	Prism ( $\Delta$ )	Base
<b>Is it <i>unlikely</i> that glasses will have a prescription outside the range:</b>	-24.00 to +20.00 DS  (DS values will be in 0.25 steps)	+/- 8.00 DC  (DC values will be in 0.25 steps)	between 0 and 180	Greater than +4.00 ADD	Greater than 20 prism dioptres ( $\Delta$ )	Up, Down, In or Out
Right (R) Eye						
Left (L) Eye						

**Note:** Some of these fields in the prescription will be blank. The first 3 fields (Sphere (Sph), Cylinder (Cyl) and Axis) will be the most commonly used. The symbol ' $\infty$ ' (infinity) is used to denote a power of 0 DS.

**It is very important that you correctly identify positive and negative values.**

**For example**, a standard prescription brought by a participant may read:

R: + 3.50 DS

L: + 4.00/-0.75 x 140

This would be documented as:

Eye	Sph (DS)	Cyl (DC)	Axis	ADD	Prism ( $\Delta$ )	Base
<b>Right (R)</b>	+3.50	-	-	-	-	-
<b>Left (L)</b>	+4.00	-0.75	140	-	-	-

**NOTE:** Empty cells should be marked as blank (as shown above).



## 13 Assessing participants' glasses

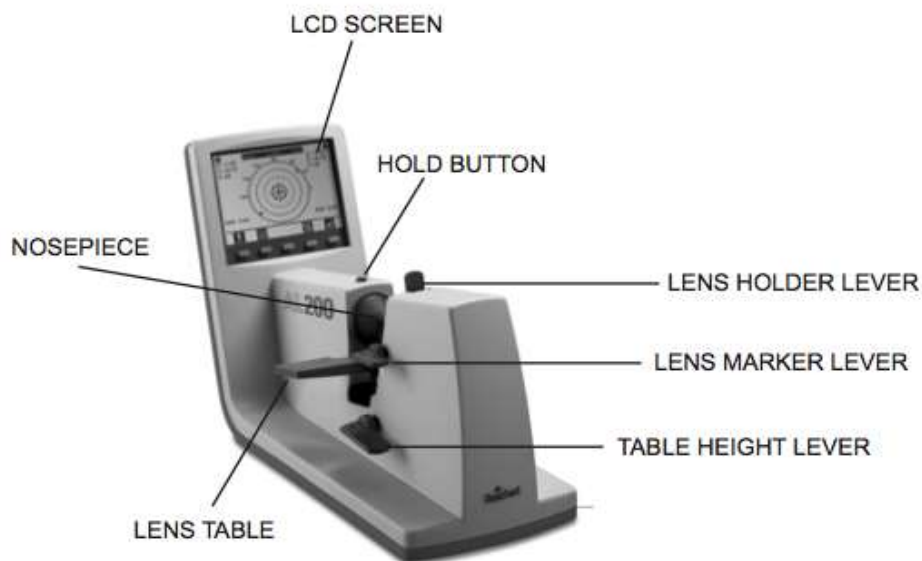
This assesses the strength of a pair of glasses. It is to be performed for any participant wearing glasses who does not have a copy of their prescription available to record.

Most participants will have single vision lenses; a small minority will have bifocal lenses. Any participant wearing progressive (varifocal) lenses will not have their glasses measured, but a note of this will be recorded in the Vision Assessment Survey.

You will need to ask the participant about when they wear their glasses. Only measure glasses used for 'distance' tasks, e.g. watching TV/driving. Do not measure glasses used for reading only. For bifocals, measure the **upper part** of the lens, as described below.

### 13.1 Equipment

Focimeter and printer



[www.reichert.com](http://www.reichert.com)

Figure 19. Reichert AL-200 Focimeter

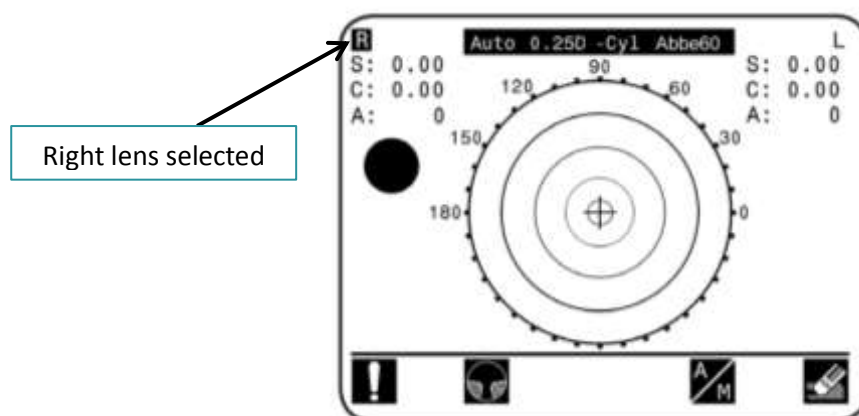
### 13.2 General Procedure

- 1 Turn the focimeter on by pressing the black switch at the back of the focimeter. The focimeter will take a few moments to calibrate. Once it has calibrated press any button to continue.

- 2 Ask the participant to remove their glasses for measurement.
- 3 Check that the focimeter is in automatic mode. If it is not, press the blue button with the A/M symbol above it.

### 13.3 Measuring single vision lenses

- 4 The focimeter measures the right lens first. Ensure the focimeter has the **right** eye measurement selected. This will be highlighted in the top left corner of the screen (Figure 21). Hold the glasses so that the lenses are nearest and the arms are pointing away as if they are about to be placed on someone else.



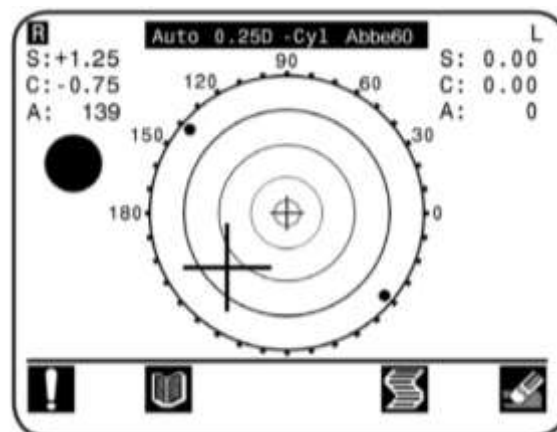
*Figure 20. Focimeter screen with right lens measurement selected*

- 5 Place the glasses on the lens table and adjust the table height lever until the right lens (i.e. lens furthest to your left) is in front of the device 'nosepiece' (Figure 22).



*Figure 21. Focimeter with glasses in place to measure the right lens*

- 6 A cross ' + ' symbol will appear on screen (Figure 23). Move the glasses on the lens table (using the table height lever) until this cross is in the centre of the screen as shown in Figure 24.



*Figure 22. Focimeter screen during lens measurement*

- 7 Measurement will start automatically and the machine will beep when measurement of the right lens is complete.

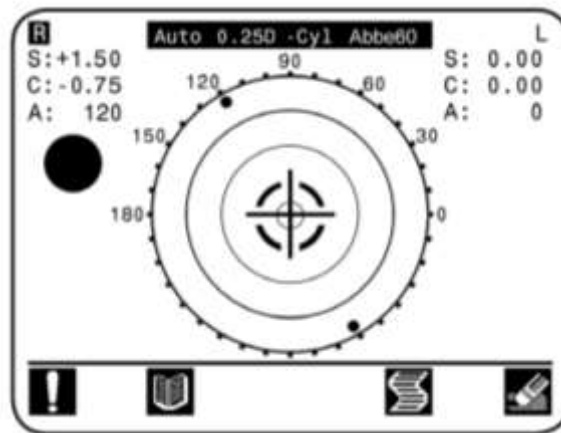


Figure 23. Focimeter screen with correct lens placement

[www.reichert.com](http://www.reichert.com)

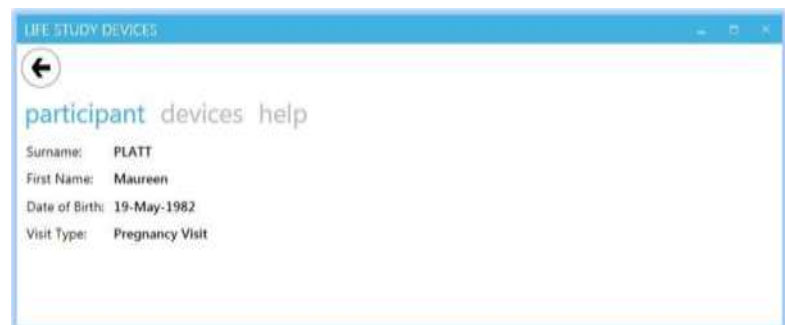
- 8 Remove the glasses from the device and re-insert with the left lens (i.e. the lens furthest to your right as you look at it) in front of the nosepiece.  
**NOTE:** The focimeter will automatically 'select' the left lens for measurement once a successful right lens measurement has been completed.
- 9 Repeat the measurement process (as described in points 5-7 above) to complete the glasses assessment.
- 10 Once measurement of the right and left lenses are complete, press the print button (fourth blue button) to print the output.
- 11 Enter the focimeter readings into the Vision Assessment Survey.
- 12 Make sure that the Desktop Device Application is running. To do this click on the shortcut as shown below:



- 13 Enter the participant's ID and select the visit type (Pregnancy Visit) using the dropdown box, then press "search".

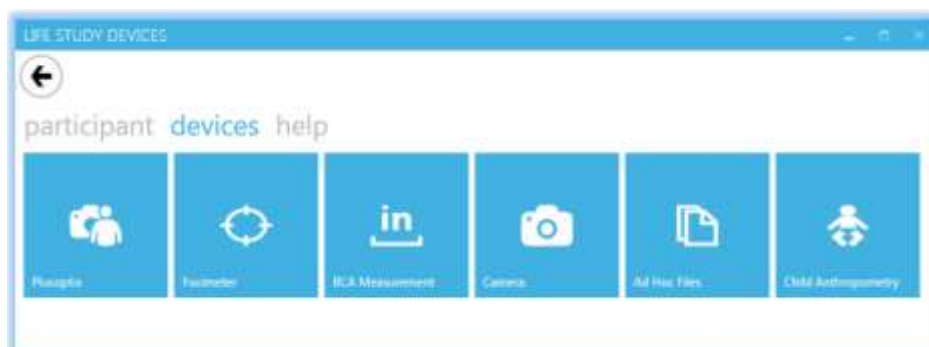


- 14 The participant’s details (name, date of birth, gender, and visit type) should appear on the screen. Check this is the correct participant. If not, use the arrow in the top left corner to take you back to the participant identification screen to re-enter the correct participant ID.



- 15 Select “devices” which appears above the participant details

- 16 Select “Focimeter”



<sup>4</sup> Note – all names and dates of birth relate to fictitious participants

17 On the computer desktop, click on HPScanning (G3110) icon.



18 Select “Document to PDF file”.

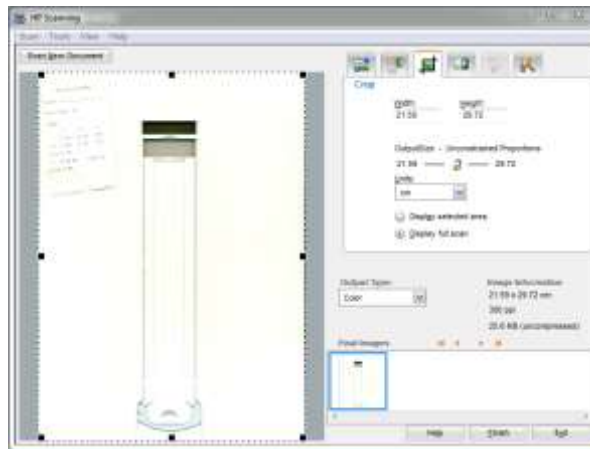


19 Turn on the scanner (the power button is on the top of the scanner).

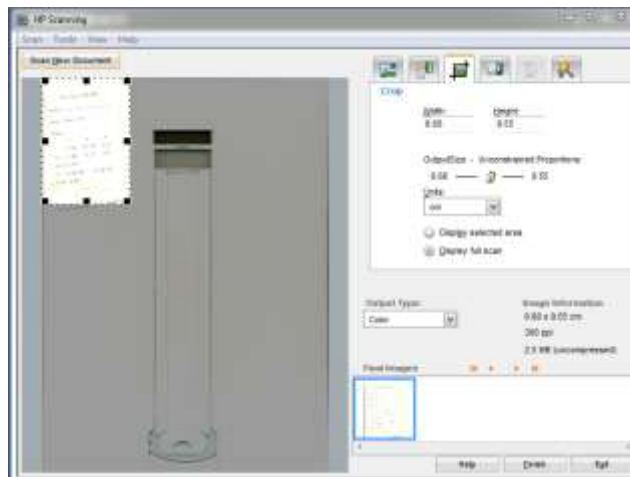
20 Open the lid of the scanner and place the focimeter printout in the top right corner.

21 Press “Scan” in the HP Scanning window.

22 Select the “Crop” tab in the HP Scanning window.



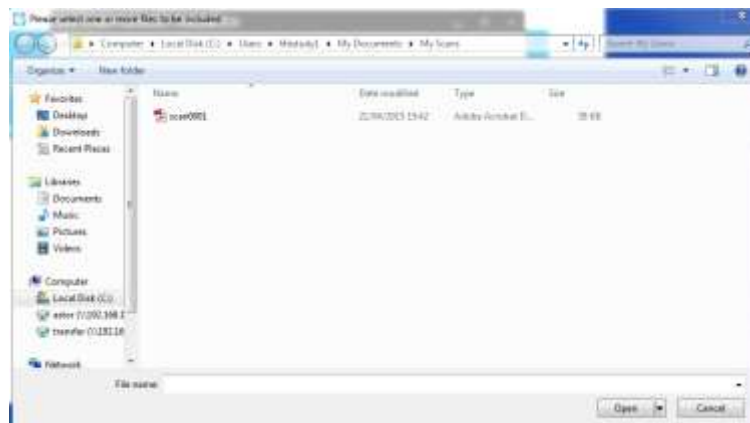
23 Then take the bottom right corner of the scanned area and drag it to select just the relevant image.



24 Press “Finish” in the HP Scanning window.

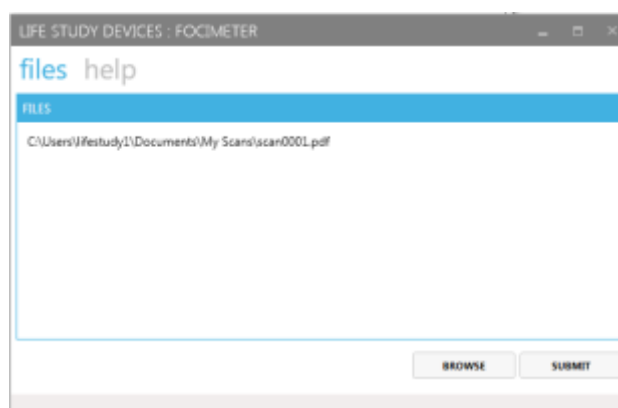
25 Close the HP Scanning window.

26 Go back to the Desktop Application Coordinator and press browse. The scanned focimeter image should have been saved under: Computer, Local Disc (C:)/Users/Lifestudy1/My Documents/My scans.



27 Click on the PDF and press “Open”.

28 Press “Submit” on the Desktop Device Coordinator.



29 Press “Yes” to confirm.

30 Press “OK”.

**NOTE:** The image is removed from the computer once the upload is successful.

31 Before beginning the next glasses assessment press the ‘clear’ button (fifth blue button) on the focimeter.

### 13.4 Measuring bifocal lenses

If the participant has bifocal lenses you will need to measure the top half of each lens only. It is important to ensure the focimeter ‘nose-piece’ is over the top half of the lens when taking a measurement.



Place the glasses on the lens table, with the right lens over the 'nose-piece'.

1. The measurement process is identical to single vision lenses (see 13.3).
2. Once measurement of the right and left lenses are complete, press the print button (fourth blue button) to print the output.
3. Save the focimeter output in the same way, as for single vision lenses.

### 13.5 Focimeter troubleshooting

If the device freezes and no measurements are possible, switch the device off using the power button. Wait 2-3 seconds and then turn the device on again. It will then re-calibrate and be ready to use again.

**NOTE:** Make sure there are no glasses on the lens table while the focimeter is calibrating.

## 14 End of the day procedures

- 1 Turn off the plusoptiX device, screen and focimeter.
- 2 Shut down the PC.

## 15 Annex: Vision Assessment Survey – Mothers and Partners

The Vision Assessment Survey was designed for use with both Adults and Infants. Textfills, indicated as ^[.....], are used to make changes to the wording so that it is appropriate for the adults when the question relates to themselves, and also when they are responding on behalf of the their infant. This document gives all the textfills, showing how the wording varies according to the participant.

Variable	Question	Responses	Universe								
<b>VisCons</b>	CHECK RELEVANT CONSENT FORM SIGNED.	Choice: single <table border="1"> <tr> <td>1</td> <td>Yes</td> </tr> <tr> <td>2</td> <td>No</td> </tr> </table>	1	Yes	2	No	If ((RespType = 1 or 2) // Mother or Partner And (ModeType = 1) // CAPI And (Sweep = 1)) // 28 weeks  OR ((RespType = 1) // Mother And (ModeType = 1) // CAPI And (Sweep = 3)) // 12 months				
1	Yes										
2	No										
<b>MissEye</b>	We can't take measurements on an artificial eye. Can I just check, ^[do you / does ^[cohort baby name]] have an eye missing or have an artificial eye?	Choice: single <table border="1"> <tr> <td>1</td> <td>Yes - both eyes missing</td> </tr> <tr> <td>2</td> <td>Yes - right eye missing</td> </tr> <tr> <td>3</td> <td>Yes - left eye missing</td> </tr> <tr> <td>4</td> <td>No</td> </tr> </table>	1	Yes - both eyes missing	2	Yes - right eye missing	3	Yes - left eye missing	4	No	If ((RespType = 1 or 2) // Mother or Partner And (ModeType = 1) // CAPI And (Sweep = 1)) // 28 weeks  OR ((RespType = 1) // Mother And (ModeType = 1) // CAPI And (Sweep = 3)) // 12 months
1	Yes - both eyes missing										
2	Yes - right eye missing										
3	Yes - left eye missing										
4	No										
<b>VisIntro</b>	I am now going to do the tests that measure different aspects of visual function, long/short sightedness and the alignment of the eyes.  The information is not equivalent to a medical assessment so we aren't feeding back the findings.  Are you happy to start the tests?	Choice: single <table border="1"> <tr> <td>1</td> <td>Participant agreed</td> </tr> <tr> <td>2</td> <td>Participant refused</td> </tr> </table>	1	Participant agreed	2	Participant refused	If ((RespType = 1 or 2) // Mother or Partner And (ModeType = 1) // CAPI And (Sweep = 1) // 28 weeks And (MissEye = 2,3,4)) // Don't have both eyes missing  OR ((RespType = 1) // Mother And (ModeType = 1) // CAPI And (Sweep = 3) // 12 months And (MissEye = 2,3,4)) // Don't have both eyes missing				
1	Participant agreed										
2	Participant refused										

Variable	Question	Responses	Universe										
WhyVisNo	Can I ask why you don't want ^[cohort baby name] to have a vision assessment?	Open: 150	<p>If ((RespType = 1 or 2) // Mother or Partner And (ModeType = 1) // CAPI And (Sweep = 1) // 28 weeks And (VisIntro = 2)) // refused Vision assessment</p> <p>OR ((RespType = 1) // Mother And (ModeType = 1) // CAPI And (Sweep = 3) // 12 months And (VisIntro = 2)) // refused Vision assessment</p>										
Glasses	<p>DOES THE PARTICIPANT WEAR GLASSES OR CONTACT LENSES, AND IF SO, DO THEY HAVE THEIR GLASSES WITH THEM OR ARE THEY WEARING THEIR CONTACT LENSES?</p> <p>CODE ALL THAT APPLY.</p>	<p>Choice: multiple</p> <table border="1"> <tr> <td>1</td> <td>They are wearing glasses</td> </tr> <tr> <td>2</td> <td>They are not wearing glasses but have glasses with them</td> </tr> <tr> <td>3</td> <td>They wear glasses but do not have the glasses with them</td> </tr> <tr> <td>4</td> <td>They are wearing contact lenses</td> </tr> <tr> <td>5</td> <td>They do not wear glasses or contact lenses</td> </tr> </table>	1	They are wearing glasses	2	They are not wearing glasses but have glasses with them	3	They wear glasses but do not have the glasses with them	4	They are wearing contact lenses	5	They do not wear glasses or contact lenses	<p>If ((RespType = 1 or 2) // Mother or Partner And (ModeType = 1) // CAPI And (Sweep = 1) // 28 weeks And (VisIntro = 1)) // agreed to proceed with vision assessments</p> <p>OR ((RespType = 1) // Mother And (ModeType = 1) // CAPI And (Sweep = 3) // 12 months And (VisIntro = 1)) // agreed to proceed with vision assessments</p>
1	They are wearing glasses												
2	They are not wearing glasses but have glasses with them												
3	They wear glasses but do not have the glasses with them												
4	They are wearing contact lenses												
5	They do not wear glasses or contact lenses												
GlassWhy	PROBE – WHEN DO THEY WEAR THEIR GLASSES	<p>Choice: single</p> <table border="1"> <tr> <td>1</td> <td>For distance viewing such as driving, watching TV</td> </tr> <tr> <td>2</td> <td>For near tasks like reading</td> </tr> <tr> <td>3</td> <td>Other</td> </tr> </table>	1	For distance viewing such as driving, watching TV	2	For near tasks like reading	3	Other	<p>If (RespType = 1 or 2) // Mother or Partner And (ModeType = 1) // CAPI And (Sweep = 1) // 28 weeks And (Glasses = 1..3) // wears glasses</p>				
1	For distance viewing such as driving, watching TV												
2	For near tasks like reading												
3	Other												
GlassRem	ASK THE PARTICIPANT TO REMOVE THEIR ^[CHILD'S] GLASSES. THIS IS NECESSARY TO TAKE A MEASUREMENT WITH THE PLUSOPTIX.	<p>Choice: single</p> <table border="1"> <tr> <td>1</td> <td>Yes</td> </tr> <tr> <td>2</td> <td>No</td> </tr> </table>	1	Yes	2	No	<p>If ((RespType = 1 or 2) // Mother or Partner And (ModeType = 1) // CAPI And (Sweep = 1) // 28 weeks And ((Glasses = 1) // wearing glasses And (Glasses &lt;&gt; 4))) // not wearing contact lenses</p> <p>OR ((RespType = 1) // mother And (ModeType = 1) // CAPI</p>						
1	Yes												
2	No												

Variable	Question	Responses	Universe						
	WAS PARTICIPANT WILLING TO REMOVE THEIR ^[CHILD'S] GLASSES?		And (Sweep = 3) // 12 months And ((Glasses = 1) // wearing glasses And (Glasses <> 4)) // not wearing contact lenses						
<b>PlusOp</b>	<p>EXPLAIN THE PLUSOPTIX ASSESSMENT TO THE PARTICIPANT I.E. THE DEVICE MEASURES LONG/SHORT-SIGHTEDNESS AND THE ALIGNMENT OF THE EYES.</p> <p>IF ADULT: YOU JUST NEED TO LOOK DIRECTLY AT THE 'NOSE' ON THE MACHINE'S 'FACE'.</p> <p>IF CHILD: YOUR CHILD NEEDS TO LOOK DIRECTLY AT THE 'NOSE' ON THE MACHINE.</p>	<p>Choice: single</p> <table border="1"> <tr> <td>1</td> <td>Participant agreed to proceed to measurement</td> </tr> <tr> <td>2</td> <td>Participant refused</td> </tr> <tr> <td>3</td> <td>Unable to measure vision for other reason</td> </tr> </table>	1	Participant agreed to proceed to measurement	2	Participant refused	3	Unable to measure vision for other reason	<p>If ((RespType = 1 or 2) // Mother or Partner And (ModeType = 1) // CAPI And (Sweep = 1) // 28 weeks And (VisIntro = 1) // agreed to vision assessment And (Glasses &lt;&gt; 4) // they are not wearing contact lenses And (GlassRem &lt;&gt; 2)) // they have not refused to remove glasses</p> <p>OR ((RespType = 1) // Mother And (ModeType = 1) // CAPI And (Sweep = 3) // 12 months And (VisIntro = 1) // agreed to vision assessment And (GlassRem &lt;&gt; 2) // they have not refused to remove glasses And (Glasses &lt;&gt; 4) // they are not wearing contact lenses</p>
1	Participant agreed to proceed to measurement								
2	Participant refused								
3	Unable to measure vision for other reason								
<b>WhyOpNo</b>	Can I ask why you don't want ^[cohort baby name] to have a Plusoptix assessment?	Open: 150	<p>If ((RespType = 1 or 2) // Mother or Partner And (ModeType = 1) // CAPI And (Sweep = 1) // 28 weeks And (PlusOp = 2)) // they have refused plusoptiX</p> <p>OR ((RespType = 1) // Mother And (ModeType = 1) // CAPI And (Sweep = 3) // 12 months And (PlusOp = 2)) // they have refused plusoptiX</p>						
<b>PlsOpInt</b>	YOU ARE NOW READY TO TAKE A PLUSOPTIX READING.	Control:	<p>If ((RespType = 1 or 2) // Mother or Partner And (ModeType = 1) // CAPI And (Sweep = 1) // 28 weeks And (PlusOp = 1)) // they have agreed to plusoptiX</p>						

Variable	Question	Responses	Universe
	<p>- ENSURE YOU ARE APPROXIMATELY 1.5 METRES FROM THE PARTICIPANT'S FACE AND THAT YOU ARE SECURELY HOLDING THE HANDLE OF THE PLUSOPTIX VISION SCREENER.</p> <p>- ENSURE THE ROOM LIGHTING HAS BEEN DIMMED</p> <p>- ENSURE THE PARTICIPANT IS LOOKING STRAIGHT ON</p> <p>- THE PLUSOPTIX MEASUREMENT BEGINS WHEN YOU PULL THE TRIGGER.</p> <p>REMEMBER:</p> <p>- INITIALLY WHITE SQUARES WILL APPEAR ON THE PLUSOPTIX READER THIS IS NORMAL.</p> <p>- IF THE CIRCLES TURN RED YOU ARE TOO FAR FORWARD. IF THIS HAPPENS MOVE THE DEVICE AWAY FROM THE PARTICIPANT.</p> <p>- THE MEASUREMENT SPONTANEOUSLY BEGINS ONCE THE GREEN CIRCLES ARE PRESENT.</p> <p>- THE DEVICE BEEPS ONCE THE MEASUREMENT IS COMPLETE.</p> <p>- A MAXIMUM OF TWO BINOCULAR ATTEMPTS CAN BE MADE AT TAKING THE PLUSOPTIX READING.</p>		<p>OR ((RespType = 1) // Mother And (ModeType = 1) // CAPI And (Sweep = 3) // 12 months And (PlusOp = 1)) // they have agreed to plusoptiX</p>

Variable	Question	Responses	Universe								
	<p>- AFTER TWO ATTEMPTS PROCEED WITH THE UNIOCLAR PLUSOPTIX ASSESSMENT.</p> <p>- IF THE PARTICIPANT HAS ONE EYE MISSING, USE THE PLUSOPTIX IN 'UNIOCLAR' MODE AND TEST ONE EYE ONLY.</p> <p>PRESS NEXT TO CONTINUE</p>										
<b>PlusObt</b>	RECORD WHETHER YOU OBTAINED A PLUSOPTIX ASSESSMENT RESULT.	<p>Choice: single</p> <table border="1"> <tr> <td>1</td> <td>Yes</td> </tr> <tr> <td>2</td> <td>No</td> </tr> </table>	1	Yes	2	No	<p>If ((RespType = 1 or 2) // Mother or Partner And (ModeType = 1) // CAPI And (Sweep = 1) // 28 weeks And (PlusOp = 1)) // they have agreed to plusoptiX</p> <p>OR ((RespType = 1) // Mother And (ModeType = 1) // CAPI And (Sweep = 3) // 12 months And (PlusOp = 1)) // they have agreed to plusoptiX</p>				
1	Yes										
2	No										
<b>EyeRai</b>	IF PARTICIPANT'S EYELID WAS RAISED TO TAKE THE PLUSOPTIX MEASUREMENT, RECORD WHICH ONE WAS RAISED.	<p>Choice: single</p> <table border="1"> <tr> <td>1</td> <td>Right</td> </tr> <tr> <td>2</td> <td>Left</td> </tr> <tr> <td>3</td> <td>Both</td> </tr> <tr> <td>4</td> <td>None</td> </tr> </table>	1	Right	2	Left	3	Both	4	None	<p>If ((RespType = 1 or 2) // Mother or Partner And (ModeType = 1) // CAPI And (Sweep = 1) // 28 weeks And (PlusOp = 1)) // they have agreed to plusoptiX</p> <p>OR ((RespType = 1) // mother And (ModeType = 1) // CAPI And (Sweep = 3) // 12 months And (PlusOp = 1)) // they have agreed to plusoptiX</p>
1	Right										
2	Left										
3	Both										
4	None										
<b>PlusRea</b>	RECORD REASON FOR NOT OBTAINING A PLUSOPTIX ASSESSMENT RESULT.	<p>Choice: single</p> <table border="1"> <tr> <td>1</td> <td>Equipment failure</td> </tr> <tr> <td>2</td> <td>Could not obtain a reading after following test protocol</td> </tr> </table>	1	Equipment failure	2	Could not obtain a reading after following test protocol	<p>If ((RespType = 1 or 2) // Mother or Partner And (ModeType = 1) // CAPI And (Sweep = 1) // 28 weeks And ((PlusOp = 3) // unable to measure vision for other reason</p>				
1	Equipment failure										
2	Could not obtain a reading after following test protocol										

Variable	Question	Responses	Universe				
		<table border="1"> <tr> <td>3</td> <td>Lack of co-operation</td> </tr> <tr> <td>4</td> <td>Other (specify)</td> </tr> </table>	3	Lack of co-operation	4	Other (specify)	<p>Or (PlusObt = 2))) // failed to get plusoptiX measurement</p> <p>OR ((RespType = 1) // mother And (ModeType = 1) // CAPI And (Sweep = 3) // 12 months And ((PlusOp = 3) // unable to measure vision for other reason Or (PlusObt = 2))) // failed to get plusoptiX measurement</p>
3	Lack of co-operation						
4	Other (specify)						
<b>OPlusRea</b>	<p>SPECIFY OTHER REASON FOR NOT OBTAINING A PLUSOPTIX MEASUREMENT.</p> <p>COMMENT ON PLUSOPTIX TEST INCLUDING DETAIL OF SPECIFIC EYE PROBLEMS AND/OR ENVIRONMENTAL PROBLEMS E.G. ROOM LIGHTING</p>	Open: 150	<p>If ((RespType = 1 or 2) // Mother or Partner And (ModeType = 1) // CAPI And (Sweep = 1) // 28 weeks And (PlusRea = 4)) // other reason failed to get plusoptiX measurement</p> <p>OR ((RespType = 1) // mother And (ModeType = 1) // CAPI And (Sweep = 3) // 12 months And (PlusRea = 4)) // other reason failed to get plusoptiX measurement</p>				
<b>POend</b>	<p>END OF PLUSOPTIX ASSESSMENT.</p> <p>DON'T FORGET TO SAVE ALL DATA.</p> <p>PRESS NEXT TO CONTINUE</p>	Control:	<p>If ((RespType = 1 or 2) // Mother or Partner And (ModeType = 1) // CAPI And (Sweep = 1) // 28 weeks And (PlusOp = 1)) // they have agreed to plusoptiX</p> <p>OR ((RespType = 1) // mother And (ModeType = 1) // CAPI And (Sweep = 3) // 12 months And (PlusOp = 1)) // they have agreed to plusoptiX</p>				
<b>FrisIntr</b>	We're now going to do a 3D vision test. For this test, ^[you are/^[Cohort baby name] is] looking for a circle like this	<p>Choice: single</p> <table border="1"> <tr> <td>1</td> <td>Participant agreed to proceed with measurement</td> </tr> </table>	1	Participant agreed to proceed with measurement	<p>If ((RespType = 1 or 2) // Mother or Partner And (ModeType = 1) // CAPI And (Sweep = 1) // 28 weeks And (VisIntro = 1)) // agreed to vision assessment</p>		
1	Participant agreed to proceed with measurement						

Variable	Question	Responses	Universe								
	<p>hidden within one of the four squares on the following plate. It may appear to be jumping out like a 3D picture.</p> <p>IF THE PARTICIPANT REMOVED THEIR GLASSES FOR THE PLUSOPTIX ASSESSMENT ASK THEM TO REPLACE THEM.</p>	<table border="1"> <tr> <td>2</td> <td>Participant refused</td> </tr> </table>	2	Participant refused	<p>OR ((RespType = 1) // Mother And (ModeType = 1) // CAPI And (Sweep = 3) // 12 months And (VisIntro = 1)) // agreed to vision assessment</p>						
2	Participant refused										
<b>FrisRef</b>	<p>Can I ask why you don't want ^[cohort baby name] to have a 3D vision test?</p>	<p>Open: 150</p>	<p>If ((RespType = 1 or 2) // Mother or Partner And (ModeType = 1) // CAPI And (Sweep = 1) // 28 weeks And (FrisIntr = 2)) // refused Frisby test</p> <p>OR ((RespType = 1) // Mother And (ModeType = 1) // CAPI And (Sweep = 3) // 12 months And (FrisIntr = 2)) // refused Frisby test</p>								
<b>FrisPL1</b>	<p>DO THE FAMILIARISATION TASK FIRST, THEN:</p> <p>PRESENT THE FIRST PLATE TO THE PARTICIPANT (THE THICKEST PLATE, WHITE STICKER)</p> <p>- HOLD IT APPROXIMATELY 30CM FROM THE PARTICIPANT'S FACE IN FRONT OF THE WHITE BOX. - HOLD THE PLATE WITH THE HIDDEN TARGET IN THE BOTTOM CORNER</p>	<p>Choice: single</p> <table border="1"> <tr> <td>1</td> <td>Positive</td> </tr> <tr> <td>2</td> <td>Negative - participant cooperative but unable to locate 3D image</td> </tr> <tr> <td>3</td> <td>Negative - unable to do test e.g. lack of co-operation</td> </tr> <tr> <td>4</td> <td>Negative - unable to interpret participant's response</td> </tr> </table>	1	Positive	2	Negative - participant cooperative but unable to locate 3D image	3	Negative - unable to do test e.g. lack of co-operation	4	Negative - unable to interpret participant's response	<p>If ((RespType = 1 or 2) // Mother or Partner And (ModeType = 1) // CAPI And (Sweep = 1) // 28 weeks And (FrisIntr = 1)) // agreed to do frisby test</p> <p>OR ((RespType = 1) // Mother And (ModeType = 1) // CAPI And (Sweep = 3) // 12 months And (FrisIntr = 1)) // agreed to do frisby test</p>
1	Positive										
2	Negative - participant cooperative but unable to locate 3D image										
3	Negative - unable to do test e.g. lack of co-operation										
4	Negative - unable to interpret participant's response										



Variable	Question	Responses	Universe								
	<p>(TARGET FACING OUT) TO YOUR LEFT SIDE. - REMEMBER TO HOLD THE PLATE WITH THE STICKER COVERED UP.</p> <p>RECORD IF THE RESPONSE TO PLATE ONE IS POSITIVE OR NEGATIVE.</p> <p>A POSITIVE RESPONSE IS THE PERSON POINTING TO (OR LOOKING AT) THE CORRECT LOCATION OF THE HIDDEN TARGET.</p>										
<b>FrisPL2</b>	<p>SHOW THE PARTICIPANT THE FIRST PLATE AGAIN (THICKEST PLATE, WHITE STICKER).</p> <p>THIS TIME HOLD THE TARGET SO THAT IT IS IN THE TOP CORNER TO YOUR LEFT SIDE.</p> <p>A POSITIVE RESPONSE IS THE PERSON POINTING TO THE CORRECT LOCATION OF THE HIDDEN TARGET.</p> <p>RECORD IF THE RESPONSE TO PLATE ONE IS POSITIVE OR NEGATIVE.</p>	<p>Choice: single</p> <table border="1"> <tr> <td>1</td> <td>Positive</td> </tr> <tr> <td>2</td> <td>Negative - participant cooperative but unable to locate 3D image</td> </tr> <tr> <td>3</td> <td>Negative - unable to do test e.g. lack of co-operation</td> </tr> <tr> <td>4</td> <td>Negative - unable to interpret participant's response</td> </tr> </table>	1	Positive	2	Negative - participant cooperative but unable to locate 3D image	3	Negative - unable to do test e.g. lack of co-operation	4	Negative - unable to interpret participant's response	<p>If ((RespType = 1 or 2) // Mother or Partner And (ModeType = 1) // CAPI And (Sweep = 1) // 28 weeks And (FrisPL1 = 2,3,4)) // negative response to plate one (first trial)</p> <p>OR ((RespType = 1) // Mother And (ModeType = 1) // CAPI And (Sweep = 3) // 12 months And (FrisPL1 = 2,3,4)) // negative response to plate one (first trial)</p>
1	Positive										
2	Negative - participant cooperative but unable to locate 3D image										
3	Negative - unable to do test e.g. lack of co-operation										
4	Negative - unable to interpret participant's response										
<b>FrisPL3</b>		Choice: single	If ((RespType = 1 or 2) // Mother or Partner And (ModeType = 1) // CAPI								

Variable	Question	Responses	Universe								
	<p>PRESENT THE SECOND PLATE TO THE PARTICIPANT (THE THINNEST PLATE, RED STICKER)</p> <p>- HOLD IT APPROXIMATELY 30CM FROM THE PARTICIPANT'S FACE IN FRONT OF THE WHITE BOX.</p> <p>- HOLD THE PLATE WITH THE HIDDEN TARGET IN THE BOTTOM CORNER (TARGET FACING OUT) TO YOUR RIGHT SIDE.</p> <p>- REMEMBER TO HOLD THE PLATE WITH THE STICKER COVERED UP.</p> <p>A POSITIVE RESPONSE IS THE PERSON POINTING TO THE CORRECT LOCATION OF THE HIDDEN TARGET.</p> <p>RECORD IF THE RESPONSE TO PLATE TWO IS POSITIVE OR NEGATIVE.</p>	<table border="1"> <tr> <td>1</td> <td>Positive</td> </tr> <tr> <td>2</td> <td>Negative - participant cooperative but unable to locate 3D image</td> </tr> <tr> <td>3</td> <td>Negative - unable to do test e.g. lack of co-operation</td> </tr> <tr> <td>4</td> <td>Negative - unable to interpret participant's response</td> </tr> </table>	1	Positive	2	Negative - participant cooperative but unable to locate 3D image	3	Negative - unable to do test e.g. lack of co-operation	4	Negative - unable to interpret participant's response	<p>And (Sweep = 1) // 28 weeks</p> <p>And ((FrisPL1 = 1) // positive response to plate one (first trial)</p> <p>Or (FrisPL2 = 1))) // positive response to plate one(second trial)</p> <p>OR ((RespType = 1) // Mother</p> <p>And (ModeType = 1) // CAPI</p> <p>And (Sweep = 3) // 12 months</p> <p>And ((FrisPL1 = 1) // positive response to plate one (first trial)</p> <p>Or (FrisPL2 = 1))) // positive response to plate one(second trial)</p>
1	Positive										
2	Negative - participant cooperative but unable to locate 3D image										
3	Negative - unable to do test e.g. lack of co-operation										
4	Negative - unable to interpret participant's response										
<b>FrisPL4</b>	<p>SHOW THE PARTICIPANT THE SECOND PLATE AGAIN (THINNEST PLATE, RED STICKER).</p> <p>THIS TIME HOLD THE TARGET SO THAT IT IS IN THE TOP CORNER TO YOUR LEFT SIDE.</p>	<p>Choice: single</p> <table border="1"> <tr> <td>1</td> <td>Positive</td> </tr> <tr> <td>2</td> <td>Negative - participant cooperative but unable to locate 3D image</td> </tr> <tr> <td>3</td> <td>Negative - unable to do test e.g. lack of co-operation</td> </tr> <tr> <td>4</td> <td>Negative - unable to interpret participant's response</td> </tr> </table>	1	Positive	2	Negative - participant cooperative but unable to locate 3D image	3	Negative - unable to do test e.g. lack of co-operation	4	Negative - unable to interpret participant's response	<p>If ((RespType = 1 or 2) // Mother or Partner</p> <p>And (ModeType = 1) // CAPI</p> <p>And (Sweep = 1) // 28 weeks</p> <p>And (FrisPL3 = 2,3,4)) // negative response to plate two (first trial)</p> <p>OR ((RespType = 1) // Mother</p> <p>And (ModeType = 1) // CAPI</p> <p>And (Sweep = 3) // 12 months</p> <p>And (FrisPL3 = 2,3,4)) // negative response to plate two (first trial)</p>
1	Positive										
2	Negative - participant cooperative but unable to locate 3D image										
3	Negative - unable to do test e.g. lack of co-operation										
4	Negative - unable to interpret participant's response										

Variable	Question	Responses	Universe						
	<p>A POSITIVE RESPONSE IS THE PERSON POINTING TO THE CORRECT LOCATION OF THE HIDDEN TARGET.</p> <p>RECORD IF THE RESPONSE TO PLATE TWO IS POSITIVE OR NEGATIVE.</p>								
RemLens	<p>ASK IF THE PARTICIPANT IS WILLING TO REMOVE THEIR CONTACT LENSES FOR THE PLUSOPTIX ASSESSMENT.</p> <p>(REMEMBER THAT IF THEY DO NOT AGREE TO REMOVE THEM YOU WILL NOT BE ABLE TO CONDUCT THE PLUSOPTIX ASSESSMENT.)</p> <p>RECORD IF THEY ARE WILLING.</p>	<p>Choice: single</p> <table border="1"> <tr> <td>1</td> <td>Yes</td> </tr> <tr> <td>2</td> <td>No</td> </tr> </table>	1	Yes	2	No	<p>If (RespType = 1 or 2) // Mother or Partner And (ModeType = 1) // CAPI And (Sweep = 1) // 28 weeks And (Glasses = 4) // wearing contact lenses</p>		
1	Yes								
2	No								
PlusOpCL	<p>EXPLAIN THE PLUSOPTIX ASSESSMENT TO THE PARTICIPANT I.E. THE DEVICE MEASURES LONG/SHORT-SIGHTEDNESS AND THE ALIGNMENT OF THE EYES. YOU JUST NEED TO LOOK DIRECTLY AT THE 'NOSE' ON THE MACHINES 'FACE'.</p>	<p>Choice: single</p> <table border="1"> <tr> <td>1</td> <td>Participant agreed to proceed to measurement</td> </tr> <tr> <td>2</td> <td>Participant refused</td> </tr> <tr> <td>3</td> <td>Unable to measure vision for other reason</td> </tr> </table>	1	Participant agreed to proceed to measurement	2	Participant refused	3	Unable to measure vision for other reason	<p>If (RespType = 1 or 2) // Mother or Partner And (ModeType = 1) // CAPI And (Sweep = 1) // 28 weeks And (RemLens = 1) // willing to remove contact lenses</p>
1	Participant agreed to proceed to measurement								
2	Participant refused								
3	Unable to measure vision for other reason								
WhyOpNCL	<p>Can I ask why you don't want to have a Plusoptix assessment?</p>	<p>Open: 150</p>	<p>If (RespType = 1 or 2) // Mother or Partner And (ModeType = 1) // CAPI And (Sweep = 1) // 28 weeks And (PlusOpCL = 2) // they have refused plusoptix</p>						
PlsOpICL		<p>Control:</p>	<p>If (RespType = 1 or 2) // Mother or Partner</p>						

Variable	Question	Responses	Universe
	<p>YOU ARE NOW READY TO TAKE A PLUSOPTIX READING.</p> <ul style="list-style-type: none"> <li>- ENSURE YOU ARE APPROXIMATELY 1.5 METRES FROM THE PARTICIPANT'S FACE AND THAT YOU ARE SECURELY HOLDING THE HANDLE OF THE PLUSOPTIX VISION SCREENER.</li> <li>- ENSURE THE ROOM LIGHTING HAS BEEN DIMMED</li> <li>- ENSURE THE PARTICIPANT IS LOOKING STRAIGHT ON</li> <li>- THE PLUSOPTIX MEASUREMENT BEGINS WHEN YOU PULL THE TRIGGER.</li> </ul> <p>REMEMBER</p> <ul style="list-style-type: none"> <li>- INITIALLY WHITE SQUARES WILL APPEAR ON THE PLUSOPTIX READER THIS IS NORMAL.</li> <li>- IF THE CIRCLES TURN RED YOU ARE TOO FAR FORWARD. IF THIS HAPPENS MOVE THE DEVICE AWAY FROM THE PARTICIPANT.</li> <li>- THE MEASUREMENT SPONTANEOUSLY BEGINS ONCE THE GREEN CIRCLES ARE PRESENT.</li> <li>- THE DEVICE BEEPS ONCE THE MEASUREMENT IS COMPLETE.</li> </ul>		<p>And (ModeType = 1) // CAPI            And (Sweep = 1) // 28 weeks            And (PlusOpCL = 1) // they have agreed to plusoptiX</p>

Variable	Question	Responses	Universe								
	<p>- A MAXIMUM OF TWO BINOCULAR ATTEMPTS CAN BE MADE AT TAKING THE PLUSOPTIX READING.</p> <p>- AFTER TWO ATTEMPTS PROCEED WITH THE UNIOCLAR PLUSOPTIX ASSESSMENT.</p> <p>PRESS NEXT TO CONTINUE</p>										
PlusObCL	RECORD WHETHER YOU OBTAINED A PLUSOPTIX ASSESSMENT RESULT.	<p>Choice: single</p> <table border="1"> <tr> <td>1</td> <td>Yes</td> </tr> <tr> <td>2</td> <td>No</td> </tr> </table>	1	Yes	2	No	<p>If (RespType = 1 or 2) // Mother or Partner And (ModeType = 1) // CAPI And (Sweep = 1) // 28 weeks And (PlusOpCL = 1) // they have agreed to plusoptiX</p>				
1	Yes										
2	No										
EyeRaiCL	IF PARTICIPANT'S EYELID WAS RAISED TO TAKE THE PLUSOPTIX MEASUREMENT, RECORD WHICH ONE WAS RAISED.	<p>Choice: single</p> <table border="1"> <tr> <td>1</td> <td>Right</td> </tr> <tr> <td>2</td> <td>Left</td> </tr> <tr> <td>3</td> <td>Both</td> </tr> <tr> <td>4</td> <td>None</td> </tr> </table>	1	Right	2	Left	3	Both	4	None	<p>If (RespType = 1 or 2) // Mother or Partner And (ModeType = 1) // CAPI And (Sweep = 1) // 28 weeks And (PlusOpCL = 1) // they have agreed to plusoptiX</p>
1	Right										
2	Left										
3	Both										
4	None										
PlusReCL	RECORD THE REASON FOR NOT OBTAINING A PLUSOPTIX ASSESSMENT RESULT.	<p>Choice: single</p> <table border="1"> <tr> <td>1</td> <td>Equipment failure</td> </tr> <tr> <td>2</td> <td>Could not obtain a reading after following test protocol</td> </tr> <tr> <td>3</td> <td>Lack of co-operation</td> </tr> <tr> <td>4</td> <td>Other (specify)</td> </tr> </table>	1	Equipment failure	2	Could not obtain a reading after following test protocol	3	Lack of co-operation	4	Other (specify)	<p>If (RespType = 1 or 2) // Mother or Partner And (ModeType = 1) // CAPI And (Sweep = 1) // 28 weeks And ((PlusOpCL = 3) // unable to measure vision for other reason Or (PlusObCL = 2)) // failed to get plusoptiX measurement</p>
1	Equipment failure										
2	Could not obtain a reading after following test protocol										
3	Lack of co-operation										
4	Other (specify)										
OPlusRCL	SPECIFY OTHER REASON FOR NOT OBTAINING A PLUSOPTIX MEASUREMENT.	Open: 150	<p>If (RespType = 1 or 2) // Mother or Partner And (ModeType = 1) // CAPI And (Sweep = 1) // 28 weeks And (PlusReCL = 4) // other reason failed to get plusoptiX measurement</p>								

Variable	Question	Responses	Universe														
	COMMENT ON PLUSOPTIX TEST INCLUDING DETAIL OF SPECIFIC EYE PROBLEMS AND/OR ENVIRONMENTAL PROBLEMS E.G. ROOM LIGHTING																
<b>POendCL</b>	END OF PLUSOPTIX ASSESSMENT.  DON'T FORGET TO SAVE ALL DATA .  PRESS NEXT TO CONTINUE	Control:	If (RespType = 1 or 2) // Mother or Partner And (ModeType = 1) // CAPI And (Sweep = 1) // 28 weeks And (PlusOpCL = 1) // they have agreed to plusoptiX														
<b>PhotoReq</b>	RECORD WHETHER YOU NEED TO TAKE A DIGITAL PHOTO AS PART OF THE VISION PROTOCOL.  IF YES, WHY?  ^[IF AN INFANT IS WEARING CONTACT LENSES CODE OPTION 5]	Choice: multiple <table border="1"> <tr> <td>1</td> <td>No, digital photograph not required</td> </tr> <tr> <td>2</td> <td>Yes, One or both eyelids had to be lifted to allow plusoptiX measurement</td> </tr> <tr> <td>3</td> <td>Yes, 'Measurement aborted' plusoptiX measurement result</td> </tr> <tr> <td>4</td> <td>Yes, Uniocular testing was required</td> </tr> <tr> <td>5</td> <td>Yes, Contact lenses or glasses were not removed to allow plusoptiX</td> </tr> <tr> <td>6</td> <td>Yes, participant refused plusoptiX assessment or unable to attempt plusoptiX assessment for other reason relating to participant</td> </tr> <tr> <td>7</td> <td>Yes, unable to attempt plusoptiX assessment because of equipment failure</td> </tr> </table>	1	No, digital photograph not required	2	Yes, One or both eyelids had to be lifted to allow plusoptiX measurement	3	Yes, 'Measurement aborted' plusoptiX measurement result	4	Yes, Uniocular testing was required	5	Yes, Contact lenses or glasses were not removed to allow plusoptiX	6	Yes, participant refused plusoptiX assessment or unable to attempt plusoptiX assessment for other reason relating to participant	7	Yes, unable to attempt plusoptiX assessment because of equipment failure	If ((RespType = 1 or 2) // Mother or Partner And (ModeType = 1) // CAPI And (Sweep = 1) // 28 weeks And (VisIntro = 1)) // agreed to vision assessments  OR ((RespType = 1) // Mother And (ModeType = 1) // CAPI And (Sweep = 3) // 12 months And (VisIntro = 1)) // agreed to vision assessments
1	No, digital photograph not required																
2	Yes, One or both eyelids had to be lifted to allow plusoptiX measurement																
3	Yes, 'Measurement aborted' plusoptiX measurement result																
4	Yes, Uniocular testing was required																
5	Yes, Contact lenses or glasses were not removed to allow plusoptiX																
6	Yes, participant refused plusoptiX assessment or unable to attempt plusoptiX assessment for other reason relating to participant																
7	Yes, unable to attempt plusoptiX assessment because of equipment failure																

Variable	Question	Responses	Universe						
<b>PhotoAgr</b>	<p>EXPLAIN TO PARTICIPANT THAT WE ARE TAKING A PHOTOGRAPH AS WE DIDN'T GET A COMPLETE MEASUREMENT WITH THE FIRST TEST.</p> <p>RECORD WHETHER THE PARTICIPANT AGREES TO HAVE A PHOTOGRAPH TAKEN.</p>	<p>Choice: single</p> <table border="1"> <tr> <td>1</td> <td>Participant agreed to proceed to take photograph</td> </tr> <tr> <td>2</td> <td>Participant refused</td> </tr> <tr> <td>3</td> <td>Unable to measure vision for other reason</td> </tr> </table>	1	Participant agreed to proceed to take photograph	2	Participant refused	3	Unable to measure vision for other reason	<p>If ((RespType = 1 or 2) // Mother or Partner And (ModeType = 1) // CAPI And (Sweep = 1) // 28 weeks And (PhotoReq = 2..7)) // photo required for protocol</p> <p>OR ((RespType = 1) // Mother And (ModeType = 1) // CAPI And (Sweep = 3) // 12 months And (PhotoReq = 2..7)) // photo required for protocol</p>
1	Participant agreed to proceed to take photograph								
2	Participant refused								
3	Unable to measure vision for other reason								
<b>PhotoWNo</b>	<p>Could I ask why you don't want ^[cohort baby name] to have a digital photo taken?</p>	<p>Open: 150</p>	<p>If ((RespType = 1 or 2) // Mother or Partner And (ModeType = 1) // CAPI And (Sweep = 1) // 28 weeks And (PhotoAgr = 2)) // refused photo</p> <p>OR ((RespType = 1) // Mother And (ModeType = 1) // CAPI And (Sweep = 3) // 12 months And (PhotoAgr = 2)) // refused photo</p>						
<b>PhotoCom</b>	<p>TAKE PHOTOGRAPH</p> <p>MAKE SURE THAT: THE CAMERA FLASH IS ON, REDUCE RED EYE IS OFF CAMERA MODE IS SET TO P. AUTOFOCUS IS SET TO ON ZOOM IS SET TO 200MM</p>	<p>Choice: single</p> <table border="1"> <tr> <td>1</td> <td>Yes</td> </tr> <tr> <td>2</td> <td>No</td> </tr> </table>	1	Yes	2	No	<p>If ((RespType = 1 or 2) // Mother or Partner And (ModeType = 1) // CAPI And (Sweep = 1) // 28 weeks And (PhotoAgr = 1)) // agreed to take photo</p> <p>OR ((RespType = 1) // Mother And (ModeType = 1) // CAPI And (Sweep = 3) // 12 months And (PhotoAgr = 1)) // agreed to take photo</p>		
1	Yes								
2	No								

Variable	Question	Responses	Universe						
	PLEASE NOTE THAT YOU CAN HAVE A MAXIMUM OF 3 ATTEMPTS TO CAPTURE A SUITABLE IMAGE  RECORD WHETHER YOU HAVE MANAGED TO TAKE A SUITABLE DIGITAL PHOTO.								
PhotoWUn	GIVE REASON FOR NOT BEING ABLE TO TAKE A DIGITAL PHOTO.	Choice: single <table border="1"> <tr> <td>1</td> <td>Equipment failure</td> </tr> <tr> <td>2</td> <td>Lack of co-operation</td> </tr> <tr> <td>3</td> <td>Other</td> </tr> </table>	1	Equipment failure	2	Lack of co-operation	3	Other	If ((RespType = 1 or 2) // Mother or Partner And (ModeType = 1) // CAPI And (Sweep = 1) // 28 weeks And ((PhotoAgr = 3) // unable to take photo Or (PhotoCom = 2))) // unable to get suitable image  OR ((RespType = 1) // Mother And (ModeType = 1) // CAPI And (Sweep = 3) // 12 months And ((PhotoAgr = 3) // unable to take photo Or (PhotoCom = 2))) // unable to get suitable image
1	Equipment failure								
2	Lack of co-operation								
3	Other								
PhotoWUO	SPECIFY OTHER REASON FOR NOT BEING ABLE TO TAKE A DIGITAL PHOTO.	Open: 150	If ((RespType = 1 or 2) // Mother or Partner And (ModeType = 1) // CAPI And (Sweep = 1) // 28 weeks And (PhotoWUn = 3)) // other reason unable to get photo  OR ((RespType = 1) // Mother And (ModeType = 1) // CAPI And (Sweep = 3) // 12 months And (PhotoWUn = 3)) // other reason unable to get photo						
PhotoNat		Choice: single	If ((RespType = 1 or 2) // Mother or Partner						



Variable	Question	Responses	Universe								
	RECORD WHETHER THE PHOTOGRAPH WAS TAKEN IN THE PARTICIPANT'S NATURAL POSITION, WITH THEIR LIDS RAISED, OR BOTH.	<table border="1"> <tr> <td>1</td> <td>Natural position</td> </tr> <tr> <td>2</td> <td>Lids raised</td> </tr> <tr> <td>3</td> <td>Lids raised plus natural position</td> </tr> </table>	1	Natural position	2	Lids raised	3	Lids raised plus natural position	<p>And (ModeType = 1) // CAPI            And (Sweep = 1) // 28 weeks            And (PhotoCom = 1)) // obtained suitable photo</p> <p>OR ((RespType = 1) // Mother            And (ModeType = 1) // CAPI            And (Sweep = 3) // 12 months            And (PhotoCom = 1)) // obtained suitable photo</p>		
1	Natural position										
2	Lids raised										
3	Lids raised plus natural position										
<b>PrescAva</b>	Do you have a copy of the prescription for ^[your / ^[cohort baby name]'s] glasses ^[or contact lenses] with you?	<p>Choice: single</p> <table border="1"> <tr> <td>1</td> <td>Yes</td> </tr> <tr> <td>2</td> <td>No</td> </tr> </table>	1	Yes	2	No	<p>If ((RespType = 1 or 2) // Mother or Partner            And (ModeType = 1) // CAPI            And (Sweep = 1) // 28 weeks            And (Glasses = 1..4)) // wear glasses or contact lenses</p> <p>OR ((RespType = 1) // Mother            And (ModeType = 1) // CAPI            And (Sweep = 3) // 12 months            And (Glasses = 1..4)) // wear glasses or contact lenses</p>				
1	Yes										
2	No										
<b>FocimInt</b>	<p>THIS TASK REQUIRES YOU TO ASSESS THE PARTICIPANTS' GLASSES. THIS SHOULD BE ADMINISTERED ON ANY ADULT WHO WEARS GLASSES FOR DISTANCE TASKS AND ON ALL CHILDREN WHO HAVE GLASSES.</p> <p>ARE YOU HAPPY FOR ME TO MEASURE THE STRENGTH OF ^[YOUR / ^[COHORT BABY NAME]'S] GLASSES?</p>	<p>Choice: single</p> <table border="1"> <tr> <td>1</td> <td>Participant agreed (and glasses not varifocals)</td> </tr> <tr> <td>2</td> <td>Participant refused</td> </tr> <tr> <td>3</td> <td>Unable - glasses are varifocals</td> </tr> <tr> <td>4</td> <td>Unable to measure vision for other reason</td> </tr> </table>	1	Participant agreed (and glasses not varifocals)	2	Participant refused	3	Unable - glasses are varifocals	4	Unable to measure vision for other reason	<p>If ((RespType = 1 or 2) // Mother or Partner            And (ModeType = 1) // CAPI            And (Sweep = 1) // 28 weeks            And (PrescAva = 2) // prescription not available            And (Glasses = 1 or 2) // they have their glasses with them            And (GlassWhy = 1 or 3)) // wear glasses for distance tasks or 'other' reason</p> <p>OR ((RespType = 1) // Mother            And (ModeType = 1) // CAPI            And (Sweep = 3) // 12 months            And (PrescAva = 2) // prescription not available            And (Glasses = 1 or 2)) // they have their glasses with them</p>
1	Participant agreed (and glasses not varifocals)										
2	Participant refused										
3	Unable - glasses are varifocals										
4	Unable to measure vision for other reason										

Variable	Question	Responses	Universe				
	ASK PARTICIPANT IF GLASSES ARE PROGRESSIVE (VARIFOCALS).  RECORD WHETHER PARTICIPANT AGREED TO FOCIMETER READING.						
<b>FocimRef</b>	Could I ask why you don't want ^[your / ^[cohort baby name]'s] glasses to be assessed?	Open: 150	If ((RespType = 1 or 2) // Mother or Partner And (ModeType = 1) // CAPI And (Sweep = 1) // 28 weeks And (FocimInt = 2)) // refused focimeter reading  OR ((RespType = 1) // Mother And (ModeType = 1) // CAPI And (Sweep = 3) // 12 months And (FocimInt = 2)) // refused focimeter reading				
<b>FocimWUn</b>	GIVE REASON FOR NOT BEING ABLE TO ATTEMPT A FOCIMETER MEASUREMENT.	Choice: single <table border="1" data-bbox="907 810 1252 874"> <tr> <td>1</td> <td>Equipment failure</td> </tr> <tr> <td>2</td> <td>Other</td> </tr> </table>	1	Equipment failure	2	Other	If ((RespType = 1 or 2) // Mother or Partner And (ModeType = 1) // CAPI And (Sweep = 1) // 28 weeks And (FocimInt = 4)) // unable to take focimeter reading  OR ((RespType = 1) // Mother And (ModeType = 1) // CAPI And (Sweep = 3) // 12 months And (FocimInt = 4)) // unable to take focimeter reading
1	Equipment failure						
2	Other						
<b>FocimWot</b>	GIVE OTHER REASON FOR NOT BEING ABLE TO DO A FOCIMETER MEASUREMENT.	Open: 150	If ((RespType = 1 or 2) // Mother or Partner And (ModeType = 1) // CAPI And (Sweep = 1) // 28 weeks And (FocimWUn = 2)) // other reason unable to take focimeter reading  OR ((RespType = 1) // Mother And (ModeType = 1) // CAPI				

Variable	Question	Responses	Universe						
			And (Sweep = 3) // 12 months And (FocimWUn = 2) // other reason unable to take focimeter reading						
<b>FocimCom</b>	<p>PROCEED WITH MEASUREMENT OF GLASSES, USING THE FOCIMETER.</p> <p>RECORD WHETHER YOU HAVE MANAGED TO TAKE A READING WITH THE FOCIMETER.</p>	<p>Choice: single</p> <table border="1"> <tr> <td>1</td> <td>Yes</td> </tr> <tr> <td>2</td> <td>No</td> </tr> </table>	1	Yes	2	No	<p>If ((RespType = 1 or 2) // Mother or Partner And (ModeType = 1) // CAPI And (Sweep = 1) // 28 weeks And (FocimInt = 1)) // agreed to focimeter reading</p> <p>OR ((RespType = 1) // Mother And (ModeType = 1) // CAPI And (Sweep = 3) // 12 months And (FocimInt = 1)) // agreed to focimeter reading</p>		
1	Yes								
2	No								
<b>FocimCNo</b>	<p>RECORD WHY YOU HAVE NOT MANAGED TO TAKE A READING WITH THE FOCIMETER.</p>	Open: 150	<p>If ((RespType = 1 or 2) // Mother or Partner And (ModeType = 1) // CAPI And (Sweep = 1) // 28 weeks And (FocimCom = 2)) // Unable to get focimeter reading</p> <p>OR ((RespType = 1) // Mother And (ModeType = 1) // CAPI And (Sweep = 3) // 12 months And (FocimCom = 2)) // Unable to get focimeter reading</p>						
<b>MeasFrom</b>	<p>RECORD THE SOURCE OF THE PRESCRIPTION / MEASUREMENTS.</p>	<p>Choice: single</p> <table border="1"> <tr> <td>1</td> <td>Glasses prescription</td> </tr> <tr> <td>2</td> <td>Contact Lens prescription</td> </tr> <tr> <td>3</td> <td>Focimeter reading</td> </tr> </table>	1	Glasses prescription	2	Contact Lens prescription	3	Focimeter reading	<p>If ((RespType = 1 or 2) // Mother or Partner And (ModeType = 1) // CAPI And (Sweep = 1) // 28 weeks And ((PrescAva = 1) // has prescription available Or (FocimCom = 1))) // obtained focimeter reading</p> <p>OR ((RespType = 1) // Mother And (ModeType = 1) // CAPI And (Sweep = 3) // 12 months And ((PrescAva = 1) // has prescription available</p>
1	Glasses prescription								
2	Contact Lens prescription								
3	Focimeter reading								

Variable	Question	Responses	Universe
			Or (FocimCom = 1))) // obtained focimeter reading
<b>RighSph</b>	<p>RECORD THE PRESCRIPTION FOR SPHERE – RIGHT EYE.</p> <p>THIS MAY BE WRITTEN AS SPH, AND THE DS VALUES WILL BE IN 0.25 STEPS.</p> <p>IF ∞ (infinity) IS SHOWN ON THE PRESCRIPTION THIS MEANS 0 DS.</p>	Number: 2, 5, -29..29	<p>If ((RespType = 1 or 2) // Mother or Partner And (ModeType = 1) // CAPI And (Sweep = 1) // 28 weeks And ((PrescAva = 1) // has prescription available Or (FocimCom = 1))) // obtained focimeter reading</p> <p>OR ((RespType = 1) // Mother And (ModeType = 1) // CAPI And (Sweep = 3) // 12 months And ((PrescAva = 1) // has prescription available Or (FocimCom = 1))) // obtained focimeter reading</p>
<b>RighCyl</b>	<p>RECORD THE PRESCRIPTION FOR CYLINDER – RIGHT EYE.</p> <p>THIS MAY BE WRITTEN AS CYL, AND THE DC VALUES WILL BE IN 0.25 STEPS.</p>	Number: 2, 4, -9..9	<p>If ((RespType = 1 or 2) // Mother or Partner And (ModeType = 1) // CAPI And (Sweep = 1) // 28 weeks And ((PrescAva = 1) // has prescription available Or (FocimCom = 1))) // obtained focimeter reading</p> <p>OR ((RespType = 1) // Mother And (ModeType = 1) // CAPI And (Sweep = 3) // 12 months And ((PrescAva = 1) // has prescription available Or (FocimCom = 1))) // obtained focimeter reading</p>
<b>RighAxis</b>	<p>RECORD THE PRESCRIPTION FOR AXIS – RIGHT EYE.</p>	Number: 0, 3, 0..180	<p>If ((RespType = 1 or 2) // Mother or Partner And (ModeType = 1) // CAPI And (Sweep = 1) // 28 weeks And ((PrescAva = 1) // has prescription available Or (FocimCom = 1))) // obtained focimeter reading</p>

Variable	Question	Responses	Universe
	(IF NOT A WHOLE NUMBER, ROUND UP TO THE NEAREST VALUE)		OR ((RespType = 1) // Mother And (ModeType = 1) // CAPI And (Sweep = 3) // 12 months And ((PrescAva = 1) // has prescription available Or (FocimCom = 1))) // obtained focimeter reading
<b>RighADD</b>	RECORD THE PRESCRIPTION FOR ADD – RIGHT EYE.	Number: 2, 4, 0..5	If ((RespType = 1 or 2) // Mother or Partner And (ModeType = 1) // CAPI And (Sweep = 1) // 28 weeks And ((PrescAva = 1) // has prescription available Or (FocimCom = 1))) // obtained focimeter reading  OR ((RespType = 1) // Mother And (ModeType = 1) // CAPI And (Sweep = 3) // 12 months And ((PrescAva = 1) // has prescription available Or (FocimCom = 1))) // obtained focimeter reading
<b>RighPris</b>	RECORD THE PRESCRIPTION FOR PRISM (Δ) – RIGHT EYE.	Number: 1, 4, 0..30	If ((RespType = 1 or 2) // Mother or Partner And (ModeType = 1) // CAPI And (Sweep = 1) // 28 weeks And ((PrescAva = 1) // has prescription available Or (FocimCom = 1))) // obtained focimeter reading  OR ((RespType = 1) // Mother And (ModeType = 1) // CAPI And (Sweep = 3) // 12 months And ((PrescAva = 1) // has prescription available Or (FocimCom = 1))) // obtained focimeter reading
<b>RighBase</b>		Choice: single	If ((RespType = 1 or 2) // Mother or Partner

Variable	Question	Responses	Universe								
	RECORD THE PRESCRIPTION FOR BASE – RIGHT EYE.	<table border="1"> <tr><td>1</td><td>Up</td></tr> <tr><td>2</td><td>Down</td></tr> <tr><td>3</td><td>In</td></tr> <tr><td>4</td><td>Out</td></tr> </table>	1	Up	2	Down	3	In	4	Out	<p>And (ModeType = 1) // CAPI            And (Sweep = 1) // 28 weeks            And ((PrescAva = 1) // has prescription available            Or (FocimCom = 1))) // obtained focimeter reading</p> <p>OR ((RespType = 1) // Mother            And (ModeType = 1) // CAPI            And (Sweep = 3) // 12 months            And ((PrescAva = 1) // has prescription available            Or (FocimCom = 1))) // obtained focimeter reading</p>
1	Up										
2	Down										
3	In										
4	Out										
<b>LeftSph</b>	<p>RECORD THE PRESCRIPTION FOR SPHERE – LEFT EYE.</p> <p>THIS MAY BE WRITTEN AS SPH, AND THE DS VALUES WILL BE IN 0.25 STEPS.</p> <p>IF ∞ (infinity) IS SHOWN ON THE PRESCRIPTION THIS MEANS 0 DS.</p>	Number: 2, 5, -29..29	<p>If ((RespType = 1 or 2) // Mother or Partner            And (ModeType = 1) // CAPI            And (Sweep = 1) // 28 weeks            And ((PrescAva = 1) // has prescription available            Or (FocimCom = 1))) // obtained focimeter reading</p> <p>OR ((RespType = 1) // Mother            And (ModeType = 1) // CAPI            And (Sweep = 3) // 12 months            And ((PrescAva = 1) // has prescription available            Or (FocimCom = 1))) // obtained focimeter reading</p>								
<b>LeftCyl</b>	<p>RECORD THE PRESCRIPTION FOR CYLINDER – LEFT EYE.</p> <p>THIS MAY BE WRITTEN AS CYL, AND THE DC VALUES WILL BE IN 0.25 STEPS.</p>	Number: 2, 4, -9..9	<p>If ((RespType = 1 or 2) // Mother or Partner            And (ModeType = 1) // CAPI            And (Sweep = 1) // 28 weeks            And ((PrescAva = 1) // has prescription available            Or (FocimCom = 1))) // obtained focimeter reading</p> <p>OR ((RespType = 1) // Mother            And (ModeType = 1) // CAPI</p>								

Variable	Question	Responses	Universe
			And (Sweep = 3) // 12 months And ((PrescAva = 1) // has prescription available Or (FocimCom = 1))) // obtained focimeter reading
<b>LeftAxis</b>	RECORD THE PRESCRIPTION FOR AXIS – LEFT EYE.  (IF NOT A WHOLE NUMBER, ROUND UP TO THE NEAREST VALUE)	Number: 0, 3, 0..180	If ((RespType = 1 or 2) // Mother or Partner And (ModeType = 1) // CAPI And (Sweep = 1) // 28 weeks And ((PrescAva = 1) // has prescription available Or (FocimCom = 1))) // obtained focimeter reading  OR ((RespType = 1) // Mother And (ModeType = 1) // CAPI And (Sweep = 3) // 12 months And ((PrescAva = 1) // has prescription available Or (FocimCom = 1))) // obtained focimeter reading
<b>LeftADD</b>	RECORD THE PRESCRIPTION FOR ADD – LEFT EYE.	Number: 2, 4, 0..5	If ((RespType = 1 or 2) // Mother or Partner And (ModeType = 1) // CAPI And (Sweep = 1) // 28 weeks And ((PrescAva = 1) // has prescription available Or (FocimCom = 1))) // obtained focimeter reading  OR ((RespType = 1) // Mother And (ModeType = 1) // CAPI And (Sweep = 3) // 12 months And ((PrescAva = 1) // has prescription available Or (FocimCom = 1))) // obtained focimeter reading
<b>LeftPris</b>		Number: 1, 4, 0..30	If ((RespType = 1 or 2) // Mother or Partner And (ModeType = 1) // CAPI And (Sweep = 1) // 28 weeks And ((PrescAva = 1) // has prescription available

Variable	Question	Responses	Universe								
	RECORD THE PRESCRIPTION FOR PRISM (Δ) – LEFT EYE.		Or (FocimCom = 1))) // obtained focimeter reading  OR ((RespType = 1) // Mother And (ModeType = 1) // CAPI And (Sweep = 3) // 12 months And ((PrescAva = 1) // has prescription available Or (FocimCom = 1))) // obtained focimeter reading								
LeftBase	RECORD THE PRESCRIPTION FOR BASE – LEFT EYE.	Choice: single <table border="1"> <tr><td>1</td><td>Up</td></tr> <tr><td>2</td><td>Down</td></tr> <tr><td>3</td><td>In</td></tr> <tr><td>4</td><td>Out</td></tr> </table>	1	Up	2	Down	3	In	4	Out	If ((RespType = 1 or 2) // Mother or Partner And (ModeType = 1) // CAPI And (Sweep = 1) // 28 weeks And ((PrescAva = 1) // has prescription available Or (FocimCom = 1))) // obtained focimeter reading  OR ((RespType = 1) // Mother And (ModeType = 1) // CAPI And (Sweep = 3) // 12 months And ((PrescAva = 1) // has prescription available Or (FocimCom = 1))) // obtained focimeter reading
1	Up										
2	Down										
3	In										
4	Out										
VisStaff	RECORD THE ID NUMBER OF THE STAFF WHO COMPLETED THE VISION ASSESSMENT	Number: 0, 4, 1000..5000	If ((RespType = 1 or 2) // Mother or Partner And (ModeType = 1) // CAPI And (Sweep = 1) // 28 weeks  Or ((RespType = 1) // Mother And (ModeType = 1) // CAPI And (Sweep = 3) // 12 Months								
VisRoom		Number: 0, 2, 1..99	If ((RespType = 1 or 2) // Mother or Partner And (ModeType = 1) // CAPI And (Sweep = 1) // 28 weeks  Or ((RespType = 1) // Mother								



<b>Variable</b>	<b>Question</b>	<b>Responses</b>	<b>Universe</b>
	ENTER THE ROOM NUMBER IN WHICH THE VISION ASSESSMENT WAS CARRIED OUT		And (ModeType = 1) // CAPI And (Sweep = 3) // 12 Months