

Distinct promoter elements mediate the co-operative effect of Brn-3a and p53 on the p21 promoter and their antagonism on the Bax promoter

C. Perez-Sanchez, V. S. Budhram-Mahadeo and D. S. Latchman*

Institute of Child Health, University College London, 30 Guilford Street, London WC1N 1EH, UK

Received July 23, 2002; Revised and Accepted September 6, 2002

ABSTRACT

Although the promoters of both the Bax and p21 genes are activated by p53, they differ in the effect on this activation of the POU family transcription factor Brn-3a. Thus, Brn-3a inhibits activation of the Bax promoter by p53 but enhances the ability of p53 to activate the p21 promoter. We demonstrate that repression of p53-mediated activation of the Bax promoter involves a complex upstream sequence in which two Brn-3a response elements flank the p53 response element. In contrast, a minimal p21 promoter is activated by Brn-3a and such activation cannot be abolished without abolishing basal promoter activity. Moreover, synergistic activation by Brn-3a and p53 continues to be observed when the p53-binding sites in the p21 promoter are substituted by the Bax p53 site or by the region of the Bax promoter essential for Brn-3a-mediated repression, indicating that the p21 core promoter plays a central role in this response. The significance of these effects is discussed in terms of the different responses of the Bax and p21 promoters and the overlapping but distinct roles of Brn-3a and p53 in neuronal growth arrest and apoptosis.

INTRODUCTION

The POU family transcription factor Brn-3a plays a key role in the survival of specific neuronal cell types during development. Thus, inhibition of Brn-3a expression using an antisense approach results in the death of sensory neurones in culture even in the presence of neurotrophic factors (1). Similarly, knock-out mice lacking a functional gene for Brn-3a show extensive losses of somato-sensory neurones with resulting death of the animal soon after birth (2,3). Conversely, over-expression of Brn-3a in sensory (1,4) or central nervous system (5) neurones protects them from stimuli which would otherwise induce death. Most importantly, this effect has also been observed *in vivo* where over-expression of Brn-3a with a viral vector protected neonatal sensory neurones from the death-inducing effects of sciatic nerve lesion (6).

Interestingly, in addition to its effects on neuronal survival, Brn-3a also has effects on neuronal differentiation. Thus, expression of Brn-3a defines the earliest post-mitotic neurones to appear in the central nervous system (7) and defects in the outgrowth of sensory neurone axons precede cell death in mice lacking Brn-3a (8). Similarly, we have demonstrated that differentiation (involving growth arrest and neurite outgrowth) in a neuronal cell line is accompanied by enhanced expression of Brn-3a (9) and that artificial over-expression of Brn-3a in this cell line can induce neuronal differentiation in the absence of stimuli which would normally induce it (10).

The effects of Brn-3a on neuronal survival and neuronal differentiation require distinct features of the molecule. Thus, differentiation can be induced by over-expression of the isolated C-terminal POU domain of Brn-3a alone (10) and this domain is sufficient for the transcriptional activation of a number of genes involved in neuronal differentiation such as SNAP25 and the neurofilament genes (10–12). Hence, this domain can act as a transcription activation domain as well as acting as a DNA-binding domain. In contrast however, protection of neuronal cells from apoptosis requires not only the POU domain of Brn-3a but also an additional N-terminal domain which is present in only one of the two forms of Brn-3a. Hence, only the long form of Brn-3a which contains this domain can induce protection from cell death-inducing stimuli whereas the short form which lacks this domain cannot do so (13). Similarly, the POU domain is insufficient for the activation by Brn-3a of genes encoding factors such as Bcl-2 and Bcl-x which have a protective effect against cell death (4,13,14).

Hence, two distinct types of promoters activated by Brn-3a exist with some, such as the neurofilaments and SNAP25, requiring only the POU domain of Brn-3a for their activation whereas others such as Bcl-2 require in addition the N-terminal domain. Interestingly, promoters activated by Brn-3a also differ in the nature of the sequences required for their transcriptional activation. Thus, some promoters, such as those of the genes encoding SNAP25 and Bcl-2, contain distinct upstream binding sites for Brn-3a which are essential for the transcriptional activation response (4,11). In contrast, in a number of other promoters the sequences required for the response to Brn-3a cannot be dissected away from the basal promoter sequence, with activation by Brn-3a being lost in a deletion analysis at the same point as basal promoter activity. Promoters of this type include those of the genes encoding

*To whom correspondence should be addressed. Tel: +44 20 7905 2189; Fax: +44 20 7242 8437; Email: d.latchman@ich.ucl.ac.uk

Bcl-x and the neurofilaments (12,14). Hence, Brn-3a-activated promoters differ in both their requirement for the N-terminus of Brn-3a and in the nature of the sequences required for the response to either the N-terminal domain or the isolated POU domain.

We have previously demonstrated in the case of both the Bcl-2 and Bcl-x promoters that transcriptional activation by Brn-3a is inhibited by over-expression of the pro-apoptotic p53 protein (14,15). Interestingly, however, once again these two promoters differ in the nature of the sequences required for p53-mediated repression. Thus, in the case of the Bcl-2 promoter, a p53-binding site located approximately 50 bases away from the Brn-3a-binding site in the upstream region of the promoter (over 500 bases upstream from the transcriptional start site) is required for transcriptional repression by p53 (15). Conversely, in the Bcl-x promoter a minimal basal promoter remains responsive to activation by Brn-3a and such activation is inhibited by p53 even on a minimal promoter construct (14). Hence, repression by p53 of the Bcl-2 and Bcl-x promoters requires, respectively, upstream sequences and basal promoter elements paralleling the distinct requirements for activation by Brn-3a on these two promoters.

We have recently demonstrated that antagonism between Brn-3a and p53 is also observed on the promoter of the pro-apoptotic Bax gene with Brn-3a inhibiting transcriptional activation of this promoter by p53 (16). Interestingly, however, a distinct effect is observed on the promoter of the cell cycle arrest gene p21 which is also activated by p53. Thus, on this promoter p53 and Brn-3a co-operate together to induce enhanced activation of the promoter compared to either factor alone (16).

In view of the complex responses to Brn-3a observed on Brn-3a-activated promoters, we wished to investigate the nature of the promoter sequences required for regulation by Brn-3a on these two p53-activated promoters in order to understand the distinct interaction between Brn-3a and p53 which occurs on these two different promoters.

MATERIALS AND METHODS

Bax and p21 promoter constructs

p21-2326, p21-587, p21-144, p21-94 vectors were a kind gift from Dr W. El-Deiry (17,18). The Bax full-length promoter construct was a kind gift from Dr J. Reed (19). The Bax-afe construct was obtained by removing the fragment between the *Pst*I and *Afe*I restriction sites from the Bax full-length plasmid. The Bax-mut and Bax-afe-mut constructs were obtained from the Bax full-length and Bax-afe plasmids, respectively. The Brn-3a responsive element (RE) located between -71 and -64 from the start site of transcription in the Bax promoter was mutated in both plasmids using the site-directed mutagenesis kit (Stratagene). Double-mut-bax construct was obtained by mutating a Brn-3a RE upstream to the p53 site, located between -166 and -155 from the start site of transcription. To obtain mixBaxp21, the fragment between positions -136 and -42 in the Bax promoter was isolated by digesting the Bax full-length construct with *Dde*I restriction enzyme and was cloned in front of the -94 bp minimal promoter of p21.

Wwp (Bsl + Bax), Wwp (Bax + Bs2) and Wwp (Bax + Bax) vectors contain the p21 promoter but have either one or both of

the p53 original sites replaced by the Bax promoter p53 site. Bax (Bs1), Bax (Bs2) and Bax (Bs1 + Bs2) vectors contain the human Bax promoter but the original p53 site was replaced by p53 site from the p21 promoter. These constructs were a kind gift from Dr E. Stanbridge (20).

p21 mut 3, p21 mut 4 and p21 mut 5,6 vectors included the p21 promoter from -2326 to +16 position but the Sp1 sites located at -82 to -77, -69 to -64 and -60 to -50 (from the start site of transcription) were respectively mutated in each construct. These constructs were a kind gift from Dr D. Kardassis (21).

Site-directed mutagenesis

The site-directed mutagenesis kit from Stratagene was used to mutate one or both of the Brn-3a REs from the Bax promoter. The Bax full-length and Bax-afe plasmids were amplified by PCR with the following primers which included the mutation in the downstream Brn-3a RE: 5'-GGC TAT ATT GCT AGC GCG CGG TCT CTG CAA AAA AC-3'; 5'-GTT TTT TGC AGA GAC CGC GCG CTA GCA ATA TAG CC-5'.

The PCR product was digested with *Dpn*I endonuclease to degrade specifically the parental DNA template. This digestion was transformed into XL-1 Blue super-competent cells. In a similar way, double-mut-bax construct was obtained from the Bax-mut construct. Bax-mut construct was amplified by PCR with the following primers which included the mutation in the upstream Brn-3a RE: 5'-GCG GTA GCT CGA GCC TGT AATC-3'; 5'-GAT TAC AGG CTC GAG CTA CCGC-3'.

Transfection

The ND7 neuronal cell line (22) was grown in L-15 medium (Gibco) supplemented with 0.35% glucose, 10% fetal calf serum, 0.35% sodium bicarbonate and 200 μ M glutamine. The cells were transfected by the calcium-phosphate method (23). Routinely, 0.7×10^5 cells were plated in 24-well plates. Two hours before transfection the medium was changed to Dulbecco's modified Eagle's medium (DMEM; Gibco) supplemented with 10% serum. Subsequently, 0.4 μ g of reporter plasmid, 0.4 μ g of Brn-3a expression vector and 0.01 μ g of p53 expression vector plus 0.02 μ g of the TK-Renilla plasmid (Promega) were transfected per well. Sonicated herring sperm DNA was added to obtain 4 μ g of total DNA per well. Four hours after adding the precipitate, DMEM medium was changed again to L.15. Cells were harvested after 48 h. Each transfection was performed at least in triplicate.

Luciferase assays

Transfected cells were lysed in 100 μ l/well of $1 \times$ passive lysis buffer (Promega) and 50 μ l from each lysate was used to measure firefly and *Renilla* luciferase activities. Both luciferase assays were quantified using a commercially available kit (Promega) and a TD-20e Luminometer. Values for firefly luciferase were divided by their corresponding *Renilla* luciferase values to obtain relative luciferase units (RLU). Reporter vector RLU was set at 100.

RESULTS

To analyse the response of the p21 promoter to Brn-3a and p53 we used a series of p21 promoter constructs containing progressively shorter upstream regions of the p21 promoter

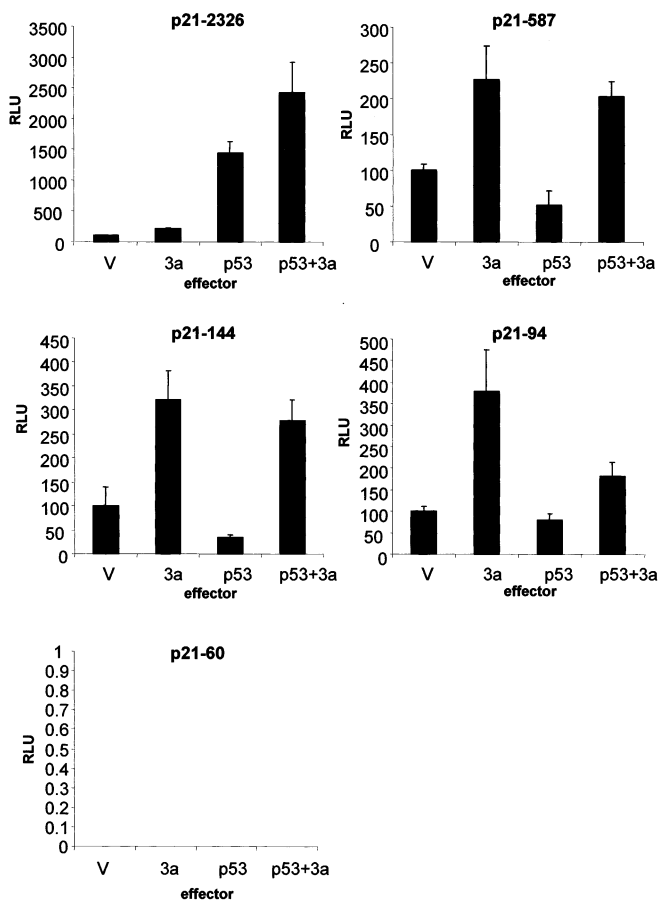

Figure 1. Luciferase assay of p21 promoter constructs, co-transfected with either empty expression vector (V) or expression vectors encoding p53 or Brn-3a. p21 promoter constructs contain the region of the promoter beginning at the upstream site indicated in each panel and ending at +16 relative to the transcriptional start site. Values are the mean of at least three independent determinations whose standard deviation is shown by the bars.

linked to a luciferase reporter gene (17,18). These constructs were transfected with Brn-3a and p53 expression vectors.

In these experiments (Fig. 1), the full-length promoter was activated both by Brn-3a and, to a greater extent, by p53 with the two factors together producing an enhanced level of activation compared to either factor alone in accordance with our previous results (16). This effect was specific to Brn-3a since the related POU family transcription factor Brn-3b failed to activate the p21 promoter and did not synergise with p53 (data not shown). As expected, deletion of the upstream region of the promoter containing two p53-binding sites resulted in a loss of activation by p53 in the construct containing 587 bases of upstream sequence and in the other, shorter, constructs (Fig. 1). However, transcriptional activation by Brn-3a continued to be observed with a construct containing only 94 bases of upstream sequence of the p21 promoter (Fig. 1). With this construct, activation by Brn-3a was actually reduced by p53, possibly due to a non-specific squelching effect in the absence of p53-binding sites. Activation by Brn-3a was only lost when the promoter was deleted so that it contained only 60 bases of upstream sequence. This promoter was not responsive to Brn-3a but also showed no basal activity indicating that the response to Brn-3a could not be dissected away from the basal activity.

Hence, the p21 promoter represents one class of Brn-3a-activated promoters in which the sequences required for Brn-3a activation cannot be dissected away from basal promoter sequences. Evidently, however, the synergistic effect with p53 requires the presence of upstream p53-binding sites in the promoter and is lost when these sites are deleted.

The p21 promoter region from -94 to +16 contains four binding sites for the Sp1 transcription factor (known as sites 3-6). To assess whether these sites play any role in the response to Brn-3a or in its interaction with p53, we used constructs in which each of these sites has been mutated in the context of the full-length p21 promoter (21). As shown in Figure 2, all these constructs continued to respond to Brn-3a and to show stronger activation with Brn-3a and p53 than with either factor alone, although there was some difference in the degree of synergy observed with each construct. Hence, none of these Sp1-binding sites is essential for the response to Brn-3a.

To investigate the nature of the regions of Brn-3a required for activation of the p21 promoter and for positive functional interaction with p53, we tested whether the isolated POU domain of Brn-3a was able to activate the promoter and to functionally interact with p53. As illustrated in Figure 3, the isolated POU domain was indeed able to activate the full-length p21 promoter and to produce stronger transcriptional activation together with p53 than was observed with either factor alone. Similarly, the isolated POU domain was able to activate a minimal p21 promoter containing only 94 bases of upstream sequence in the same manner as occurred for full-length Brn-3a. As in the case of full-length Brn-3a, the p21-94 promoter did not exhibit enhanced activation by p53 and the Brn-3a POU domain together since it lacks p53-binding sites. Indeed activation by the Brn-3a POU domain was reduced by p53 (Fig. 3) as was observed for full-length Brn-3a (Fig. 1). Hence, the p21 promoter represents a Brn-3a-inducible promoter where induction is dependent on basal promoter sequences and upon the isolated POU domain alone. Similarly, functional interaction with p53 on this promoter requires the p53-binding sites in the promoter and the Brn-3a POU domain which has previously been shown to be the region which interacts with p53 via a protein-protein interaction (15).

In contrast to the p21 promoter, the Bax promoter contains a single upstream binding site for p53 which has been shown to be essential for its transcriptional induction by p53 (19). In a combined deletion/mutation analysis, we identified two sites, respectively, upstream and downstream of this p53 site which were essential for the inhibition of p53-mediated activation by Brn-3a (for details of constructs used in this analysis see Fig. 4). As expected, the full-length Bax promoter was strongly inducible by p53 and this induction was reduced by Brn-3a (Fig. 5A) in accordance with our previous results (16). Deletion of the region upstream of the p53 site in the construct Bax-afe resulted in a construct that continued to be inducible by p53 and was also repressible by Brn-3a (Fig. 5B) ($P < 0.01$). However, further mutation of a site downstream of the p53 site within the Bax-afe construct resulted in a construct (Bax-afe-mut) that continued to be induced by p53 but which was not repressible by Brn-3a (Fig. 5D).

Hence, this site downstream of the p53 site is involved in repression by Brn-3a. However, this site does not act alone

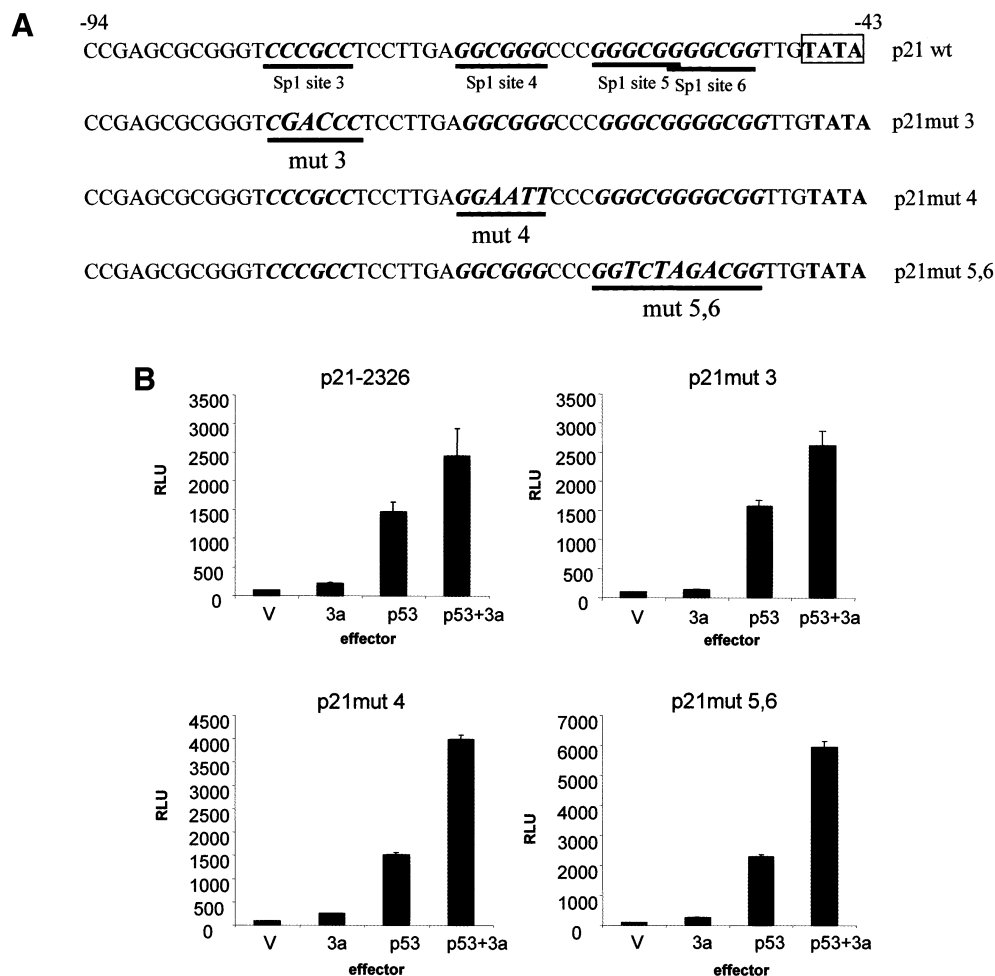

Figure 2. (A) Sequence of the p21 promoter from -94 to -43 showing the Sp1-binding sites and their inactivation in the mutant constructs. (B) Luciferase assay showing the results of co-transfecting p21 constructs containing the full-length promoter with a mutation in the indicated Sp1 site, with either empty expression vector or expression vectors encoding Brn-3a or p53. Values are the mean of at least three independent determinations whose standard deviation is shown by the bars.

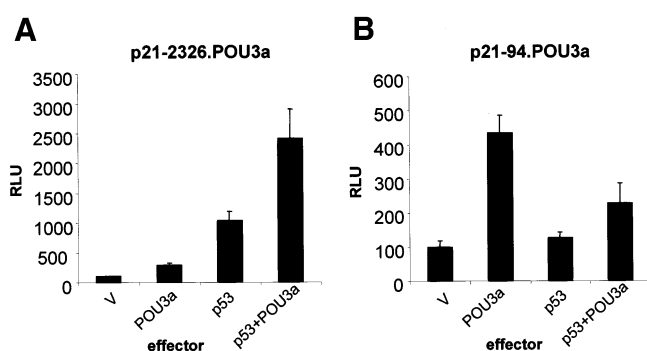

Figure 3. Luciferase assay showing the result of transfecting the full-length p21 promoter (A) or the -94 promoter (B) with empty expression vector (V) or the same vector encoding either the isolated POU domain of Brn-3a or p53. Values are the mean of at least three independent determinations whose standard deviation is shown by the bars.

since its mutation within the context of the full-length Bax promoter (Bax-mut) resulted in a construct that was still repressible by Brn-3a (Fig. 5C). Thus, abolition of repression

by Brn-3a requires not only mutation of this downstream site but also of the region of the promoter upstream of the p53 site. This dependence on the upstream region was explained by further mutation of another site upstream of the p53 site. When this site is mutated together with the downstream site, in the construct double-mut-bax, then repression by Brn-3a is abolished (Fig. 5E).

Hence, repression by Brn-3a requires the presence of two Brn-3a response elements within the Bax promoter which are, respectively, upstream and downstream of the p53 site. Inactivation of both of these sites either by mutation or deletion results in a promoter that is still inducible by p53 but where this inducibility is not reduced by Brn-3a. In contrast, mutation or deletion of either site alone results in a promoter in which induction by p53 can still be repressed by Brn-3a. Although both these sites were identified in the Bax promoter during deletion analysis by virtue of their resemblance to consensus binding sites for Brn-3a (24), we were unable to detect binding of Brn-3a to these sites using DNA mobility shift assays in the presence or absence of p53 (data not shown). It is possible, therefore, that Brn-3a exerts its effect

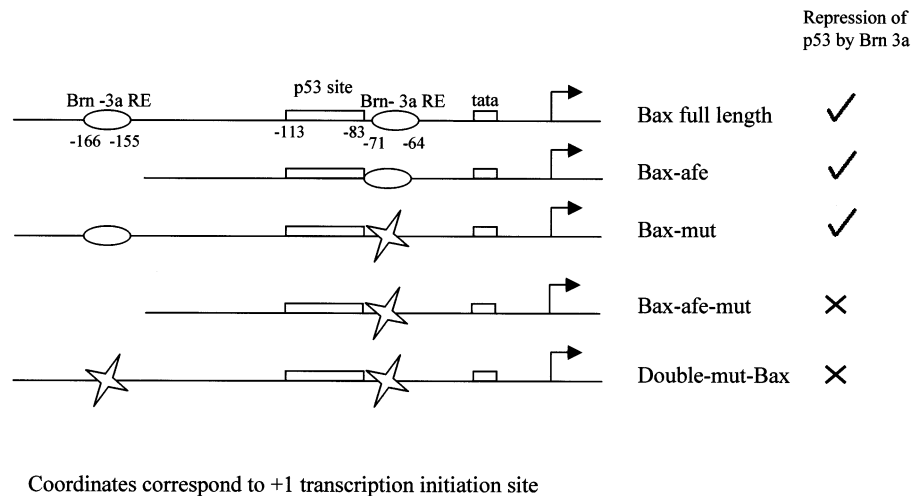

Figure 4. Bax promoter constructs used in this study and their response to Brn-3a. The position of the p53 site is shown by the box and the position of the two Brn-3a response elements (Brn-3a RE) by the ovals. A star indicates a mutated Brn-3a response element.

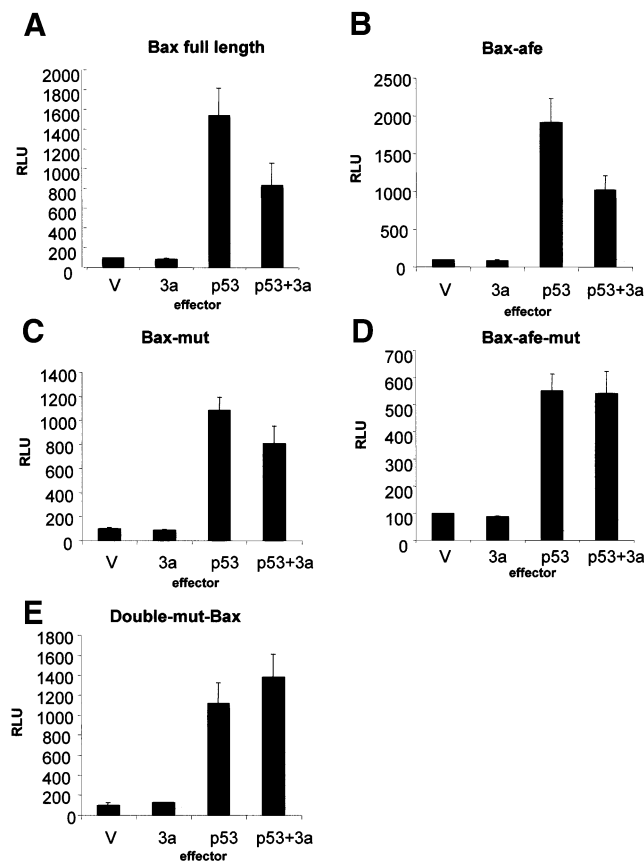

Figure 5. Luciferase assay showing the response of different Bax promoter constructs (illustrated in Fig. 4) when transfected with empty expression vector (V) or the same vector encoding either p53 or Brn-3a. Values are the mean of at least three independent determinations whose standard deviation is shown by the bars.

by binding to other factors which are already bound to these sites or alternatively that it binds to the sites with binding characteristics which are not amenable to detection by DNA mobility shift assays.

To further probe the features of Brn-3a that are required for repression of p53 inducibility, we determined whether the isolated POU domain was able to repress induction by p53 in the context of the full-length Bax promoter. As illustrated in Figure 6, this was not the case with the POU domain being unable to repress induction of the promoter by p53. Hence, repression of p53 induction on the Bax promoter requires a region of Brn-3a outside the POU domain, although the POU domain is necessary and sufficient for induction of the p21 promoter and co-operation with p53 on the p21 promoter.

To further investigate the different responses of the two promoters, we investigated the effect of exchanging the p53-binding sites in the two promoters. Thus, each of the two p53-binding sites in the p21 promoter was replaced by the binding site from the Bax promoter either individually or together (20) (Fig. 7). Each of these constructs was induced by both p53 and by Brn-3a, with maximal activation being observed with the two factors together (Fig. 7) ($P < 0.02$). Hence, the p21 promoter continues to show a synergistic activation by p53 and Brn-3a even when its p53-binding sites are substituted with the p53-binding site from the Bax promoter.

However, a different result was observed when the p53-binding site in the Bax promoter was replaced by one or both of the binding sites from the p21 promoter (Fig. 8). In this case, strong activation by p53 continued to be observed but this was either unaffected or actually increased by addition of Brn-3a, in contrast to the inhibition of activation produced by Brn-3a on the intact promoter. This effect was observed despite the fact that all the constructs contained the Brn-3a response element downstream of the p53-binding site which is sufficient for repression of p53-mediated activation on the intact Bax promoter.

Hence, it appears that the p53-binding site from the Bax promoter together with the adjacent downstream Brn-3a response element are both required for the repression of p53-mediated activation by Brn-3a. To investigate this effect further, we linked the p53 site from the Bax promoter together with the adjacent Brn-3a response element to the minimal p21 promoter containing 94 bases of upstream regulatory

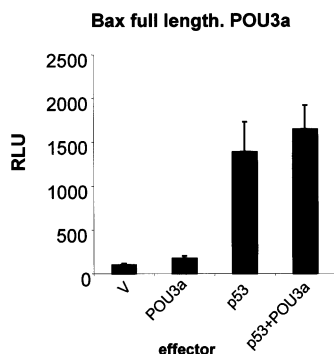

Figure 6. Luciferase assay showing the result of transfecting the full-length Bax promoter construct with either empty expression vector (V) or expression vectors encoding p53 or the isolated POU domain of Brn-3a. Values are the mean of at least three independent determinations whose standard deviation is shown by the bars.

sequence. As illustrated in Figure 1 the -94 base pair p21 promoter construct retains inducibility by Brn-3a but is not inducible by p53 due to the absence of p53-binding sites. As indicated in Figure 9, the addition of the Bax p53-binding site rendered this promoter inducible by p53 ($P < 0.05$). Most importantly, very strong co-operation between Brn-3a and p53 was observed on this promoter construct with activation in the presence of both factors being much greater than with either factor alone.

Hence, the combination of the Brn-3a inducible minimal p21 promoter with an upstream p53-binding site produces strong synergistic activation of transcription even when the two elements are separated by a Brn-3a response element which normally produces inhibition of p53-mediated transcriptional activation.

DISCUSSION

In several Brn-3a-inducible promoters, it has proved possible to define upstream binding sites for Brn-3a within the promoter which are necessary for Brn-3a-mediated induction of the promoter (4,11,25). In other promoters, however, it has proved impossible to delete putative regions involved in mediating Brn-3a inducibility without destroying the basal activity of the promoter (12,14,26).

Here, we demonstrate that the p21 promoter falls into this second class of Brn-3a inducible promoters since we were not able to eliminate Brn-3a inducibility without completely inactivating the promoter. Moreover, this characteristic of the p21 promoter appears to be crucial to the manner in which it responds to Brn-3a and p53 when the two factors are present together. Thus, co-operation between Brn-3a and p53 on this promoter is observed not only with its natural p53-binding sites but also when these sites are substituted with that of the Bax promoter. Moreover, co-operation between p53 and Brn-3a is observed even when the minimal p21 promoter is linked to the p53-binding site from the Bax promoter but the two elements are separated by a Brn-3a response element from the Bax promoter which normally produces inhibition of p53-mediated transactivation. Hence, the characteristics of the core p21 promoter predominate even in the presence of upstream elements from the Bax promoter which are normally sufficient to produce Brn-3a-mediated repression of p53 transactivation.

The -94 to $+16$ p21 promoter which responds to Brn-3a contains multiple binding sites for the Sp1 transcription factor. However, mutation of each of these sites within the full-length p21 promoter did not affect its response to Brn-3a or the functional interaction of Brn-3a with p53. Hence, the response to Brn-3a does not appear to depend on the known transcription factor binding sites within the minimal responsive p21

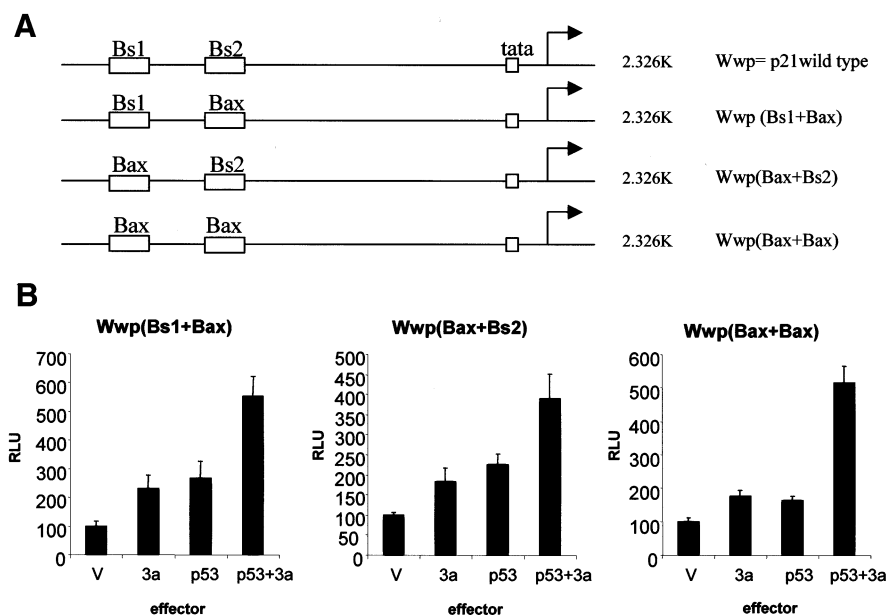

Figure 7. (A) Schematic diagram of p21 promoter constructs in which the p53-binding sites (Bs1 and Bs2) have been replaced either individually or together with the p53-binding site from the Bax promoter. (B) Luciferase assay showing the responses of the different promoter constructs when co-transfected with empty expression vector (V) or the same vector expressing either p53 or Brn-3a. Values are the mean of at least three independent determinations whose standard deviation is shown by the bars.

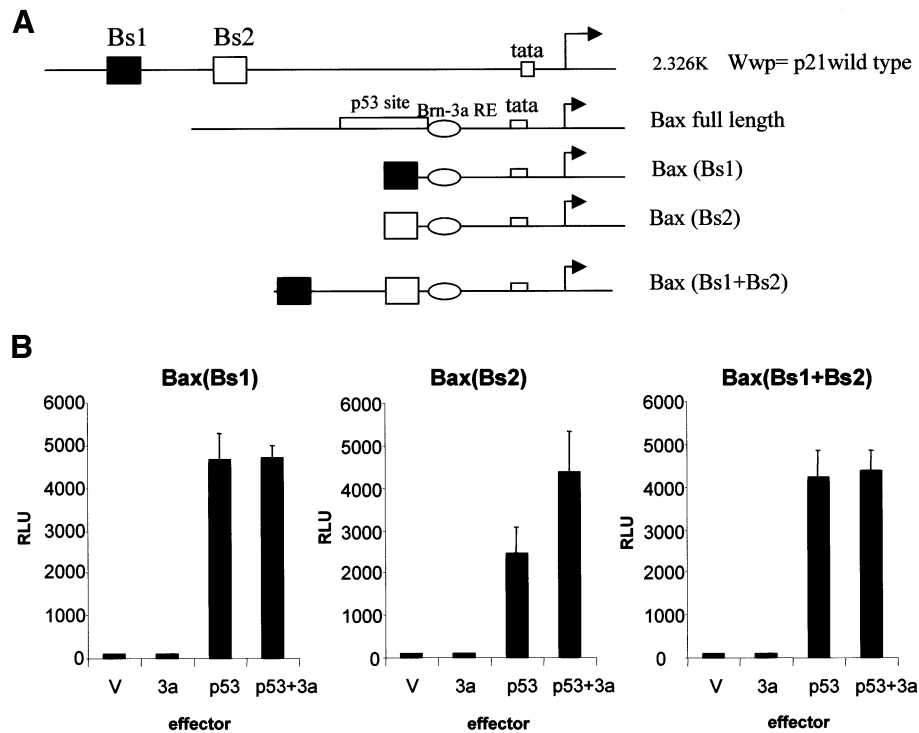

Figure 8. (A) Schematic diagram of Bax promoter constructs in which the p53-binding site (open box) has been replaced by either or both of the binding sites from the p21 promoter (Bs1 and Bs2). (B) Luciferase assay showing the responses of the different promoter constructs when co-transfected with empty expression vector (V) or the same vector expressing either p53 or Brn-3a. Values are the mean of at least three independent determinations whose standard deviation is shown by the bars.

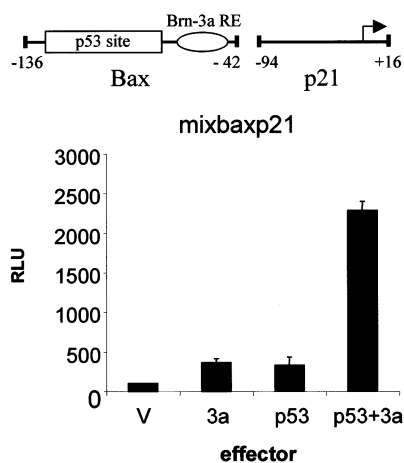

Figure 9. Luciferase assay showing the response of a p21 promoter construct containing the promoter from -94 to +16 linked to the region of the Bax promoter (-136 to -42) containing the p53-binding site and the downstream Brn-3a response element. The construct was co-transfected either with empty expression vector (V) or with the same vector expressing either p53 or Brn-3a. Values are the mean of at least three independent determinations whose standard deviation is shown by the bars.

promoter. It would be of interest, however, to determine whether mutations in the Sp1 sites would have any effect in the context of the minimal p21 promoter linked to the Bax upstream element.

The ability of Brn-3a to activate the minimal p21 promoter in an Sp1-independent manner together with the identification

of several other Brn-3a-inducible core promoters (12,14,26) suggests that Brn-3a may join the basal transcriptional complex of RNA polymerase II and associated factors on certain promoters and that the response to other factors is therefore determined by their interaction with this basal complex containing Brn-3a. Hence, on the p21 promoter, p53 bound at any upstream site would be able to interact with Brn-3a in the basal complex via the protein-protein interaction which we have demonstrated previously (15) and induce activation. This would occur even in the presence of other upstream elements which normally would produce repression of p53-mediated transactivation.

In contrast to the relatively simple situation on the p21 promoter where the core promoter determines its characteristics, the situation on the Bax promoter appears to be much more complex. Thus, we have identified a region in the Bax promoter with two Brn-3a response elements flanking the p53-binding site. Mutation or deletion of either of these response elements is insufficient to prevent Brn-3a repression of p53 inducibility whereas deletion or inactivation of both prevents the effect. Hence, either of these elements is sufficient for blocking p53-mediated transactivation. However, such inactivation is also sensitive to the nature of the p53-binding site since substitution of this site with either site from the p21 promoter prevents the inhibitory effect of Brn-3a.

It is likely, therefore, that p53 binds in a particular conformation to this Bax-binding site which allows it to interact with Brn-3a bound at an adjacent site in such a manner as to inhibit its transactivation potential. It is this interaction and the precise arrangement of the sites that

provides the Bax promoter with its characteristic inducibility by p53 and inhibition of such inducibility by Brn-3a. It should be noted, however, that these effects are not observed when this element is transferred to the p21 promoter indicating that the basal inducibility of this promoter by Brn-3a predominates and that p53 bound to its site in the Bax promoter can cooperate with Brn-3a under suitable circumstances. Interestingly, reactivity with different anti-p53 antibodies suggests that p53 may bind to the Bs1 site in the p21 promoter differently compared to the Bs2 site or the site in the Bax promoter (27,28).

As well as their different responses to Brn-3a, the Bax and p21 promoters also differ in the region of Brn-3a that is required for its effect on the promoter. Thus, the POU domain of Brn-3a is sufficient for activation of the p21 promoter as has also been observed on several other promoters (10–12). However, other regions of Brn-3a are required on the Bax promoter since the POU domain alone does not produce repression of p53-mediated transactivation. This effect is of particular interest in view of the different functional activities of the p21 and Bax proteins and their role in the response to p53. Thus, the p21 factor is involved in growth arrest induced by enhanced expression of p53 (17,18), whereas the Bax protein is associated with its ability to induce apoptosis (19). This is of particular interest since we have previously demonstrated that the isolated POU domain of Brn-3a is sufficient to induce neuronal differentiation (10), whereas the N-terminal domain of Brn-3a is required in addition to the POU domain for its anti-apoptotic effect (13).

Over-expression of p53 in cells, for example, exposed to DNA-damaging agents, can result in either cell cycle arrest allowing the damage to be repaired or the induction of apoptosis in cells which cannot repair the damage (29). Hence, Brn-3a could act in these circumstances to promote p53-mediated growth arrest via the synergistic activation of the p21 promoter by Brn-3a and p53 and conversely block p53-mediated apoptosis by inhibiting the p53-mediated transactivation of the Bax promoter. Indeed, we have previously demonstrated that cells over-expressing Brn-3a and p53 together show an enhanced rate of growth arrest and a reduced rate of apoptosis compared to cells expressing p53 alone (16). Such a role for Brn-3a would be opposite to that of the ASPP factors which specifically stimulate the apoptotic activity of p53 (30).

Therefore, by producing distinct effects of Brn-3a on p53-mediated transactivation, the different architectures of the p21 and Bax promoters may play a key role in determining the balance between growth arrest and apoptosis in cells over-expressing p53. Moreover, the fact that the effect on the p21 promoter can be achieved by the isolated POU domain of Brn-3a, whereas the effect on the Bax promoter cannot, provides an additional level of regulation since Brn-3a exists in two distinct forms both of which contain the POU domain but one of which lacks the N-terminal domain required for the anti-apoptotic effect of Brn-3a (31).

ACKNOWLEDGEMENTS

We thank Dr Wafik El-Deiry (p21 promoter constructs), Dr D. Kardassis (Spl mutant constructs), Dr John Reed (Bax promoter constructs) and Dr Eric Stanbridge (Bax/p21

constructs with exchanged p53 sites) for the very kind gift of constructs essential for this study. This work was supported by the Association for International Cancer Research, the Cancer Research Campaign, the Medical Research Council and the Wellcome Trust.

REFERENCES

1. Ensor,E., Smith,M.D. and Latchman,D.S. (2001) The Brn-3a transcription factor protects sensory but not sympathetic neurones from programmed cell death/apoptosis. *J. Biol. Chem.*, **276**, 5204–5212.
2. McEvilly,R.J., Erkman,L., Luo,L., Sawchenko,P.E., Ryan,A.F. and Rosenfeld,M.G. (1996) Requirement for Brn-3.0 in differentiation and survival of sensory and motor neurons. *Nature*, **384**, 574–577.
3. Xiang,M., Gan,L., Zhou,L., Klein,W.H. and Nathans,J. (1996) Targeted deletion of the mouse POU domain gene Brn-3a causes a selective loss of neurons in the brainstem and trigeminal ganglion, uncoordinated limb movement and impaired suckling. *Proc. Natl Acad. Sci. USA*, **93**, 11950–11955.
4. Smith,M.D., Ensor,E.A., Coffin,R.S., Boxer,L.M. and Latchman,D.S. (1998) Bcl-2 transcription from the proximal P2 promoter is activated in neuronal cells by the Brn-3a POU transcription factor. *J. Biol. Chem.*, **273**, 16715–16722.
5. PayneSmith,M.D., Ensor,E., Kinloch,R. and Latchman,D.S. (2001) The POU domain transcription factor Brn-3a protects cortical neurones from apoptosis. *Neuroreport*, **12**, 3183–3188.
6. Smith,M.D., Melton,L.A., Ensor,E.A., Packham,G., Anderson,P., Kinloch,R.A. and Latchman,D.S. (2001) Brn-3a activates the expression of Bcl-X_L and promotes neuronal survival *in vivo* as well as *in vitro*. *Mol. Cell. Neurosci.*, **17**, 460–470.
7. Fedtsova,N.G. and Turner,E.E. (1995) Brn-3.0 expression identifies early post-mitotic CNS neurons and sensory neural precursors. *Mech. Dev.*, **53**, 291–304.
8. Eng,S.R., Gratwick,K., Rhee,J.M., Fedtsova,N., Gan,L. and Turner,E.E. (2001) Defects in sensory axon growth precede neuronal death in Brn3a-deficient mice. *J. Neurosci.*, **21**, 541–549.
9. Lillycrop,K.A., Budhram-Mahadeo,V.S., Lakin,N.D., Terrenghi,G., Wood,J.N., Polak,J.M. and Latchman,D.S. (1992) A novel POU family transcription factor is closely related to Brn-3 but has a distinct expression pattern in neuronal cells. *Nucleic Acids Res.*, **20**, 5093–5096.
10. Smith,M.D., Dawson,S.J. and Latchman,D.S. (1997) The Brn-3a transcription factor induces neuronal process outgrowth and the co-ordinate expression of genes encoding synaptic proteins. *Mol. Cell. Biol.*, **17**, 345–354.
11. Lakin,N.D., Morris,P.J., Theil,T., Sato,T.N., Moroy,T., Wilson,M.C. and Latchman,D.S. (1995) Regulation of neurite outgrowth and SNAP-25 gene expression by the Brn-3a transcription factor. *J. Biol. Chem.*, **270**, 15858–15863.
12. Smith,M.D., Morris,P.J., Dawson,S.J., Schwartz,M.L., Schlaepfer,W.W. and Latchman,D.S. (1997) Co-ordinate induction of the three neurofilament genes by the Brn-3a transcription factor. *J. Biol. Chem.*, **272**, 21325–21333.
13. Smith,M.D., Dawson,S.J., Boxer,L.M. and Latchman,D.S. (1998) The N-terminal domain unique to the long form of the Brn-3a transcription factor is essential to protect neuronal cells from apoptosis and for the activation of Bcl-2 gene expression. *Nucleic Acids Res.*, **26**, 4100–4107.
14. Sugars,K.L., Budhram-Mahadeo,V., Packham,G. and Latchman,D.S. (2001) A minimal Bcl-x promoter is activated by Brn-3a and repressed by p53. *Nucleic Acids Res.*, **29**, 4530–4540.
15. Budhram-Mahadeo,V.S., Morris,P.J., Smith,M.D., Midgeley,C.A., Boxer,L.M. and Latchman,D.S. (1999) p53 suppresses the activation of the Bcl-2 promoter by the Brn-3a POU family transcription factor. *J. Biol. Chem.*, **274**, 15237–15244.
16. Budhram-Mahadeo,V.S., Morris,P.J. and Latchman,D.S. (2002) The Brn-3a transcription factor inhibits the pro-apoptotic effect of p53 and enhances cell cycle arrest by differentially regulating the activity of the p53 target genes encoding Bax and p21^{CIP1/Waf1}. *Oncogene*, **21**, 6123–6131.
17. El-Deiry,W.S., Tokino,T., Velculescu,V.E., Levy,D.B., Parsons,R., Trent,J.M., Lin,D., Mercer,W.E., Kinzler,K.W. and Vogelstein,B. (1993) WAF1, a potential mediator of p53 tumor suppression. *Cell*, **75**, 817–825.

18. Zeng, Y.X., Somasundaram, K. and El-Deiry, W.S. (1997) AP2 inhibits cancer cell growth and activates p21WAF1/CIP1 expression. *Nature Genet.*, **15**, 78–82.
19. Miyashita, T. and Reed, J.C. (1995) Tumor suppressor p53 is a direct transcriptional activator of the human *bax* gene. *Cell*, **80**, 293–299.
20. Kong, X.T., Gao, H. and Stanbridge, E.J. (2001) Mechanisms of differential activation of target gene promoters by p53 hinge domain mutants with impaired apoptotic function. *J. Biol. Chem.*, **276**, 32990–33000.
21. Koutsodontis, G., Tentes, I., Papakosta, P., Moustakas, A. and Kardassis, D. (2001) Sp1 plays a critical role in the transcriptional activation of the human cyclin-dependent kinase inhibitor p21 (WAF1/Cip1) gene by the p53 tumour suppressor protein. *J. Biol. Chem.*, **276**, 29116–29125.
22. Wood, J.N., Bevan, S.J., Coote, P., Darn, P.M., Hogan, P., Latchman, D.S., Morrison, C., Rougon, G., Theveniau, M. and Wheatley, S.C. (1990) Novel cell lines display the properties of nociceptive sensory neurons. *Proc. R. Soc. Lond. B Biol. Sci.*, **241**, 187–194.
23. Gorman, C.M. (1985) High efficiency gene transfer into mammalian cells. In Glover, D.M. (ed.), *DNA Cloning, A Practical Approach*. IRL Press, Oxford, UK, Vol. 2, pp. 143–190.
24. Gruber, C.A., Rhee, J.M., Gleiberman, A. and Turner, E.E. (1997) POU domain factors of the Brn-3 class recognise functional DNA elements, which are distinctive, symmetrical and highly conserved in evolution. *Mol. Cell. Biol.*, **17**, 2391–2400.
25. Trieu, M., Rhee, J.M., Fedtsova, N. and Turner, E.E. (1999) Autoregulatory sequences are revealed by complex stability screening of the Mouse *brn-3.0* locus. *J. Neurosci.*, **19**, 6549–6558.
26. Budhram-Mahadeo, V.S., Morris, P.J., Lakin, N.D., Theil, T., Ching, G.Y., Lillycrop, K.A., Moroy, T., Liem, R.K.H. and Latchman, D.S. (1995) Activation of the α -interneuron promoter by the Brn-3a transcription factor is dependent on the N-terminal region of the protein. *J. Biol. Chem.*, **270**, 2853–2858.
27. Resnick-Silverman, L., St. Clair, S., Maurer, M., Zhao, K. and Manfredi, J.J. (1998) Identification of a novel class of genomic DNA-binding sites suggests a mechanism for selectivity in target gene activation by the tumor suppressor protein p53. *Genes Dev.*, **12**, 2102–2107.
28. Thornborrow, E.C. and Manfredi, J.J. (1999) One mechanism for cell type-specific regulation of the *bax* promoter by the tumor suppressor p53 is dictated by the p53 response element. *J. Biol. Chem.*, **274**, 33747–33756.
29. Ko, L.J. and Prives, C. (1996) p53: puzzle and paradigm. *Genes Dev.* **10**, 1054–1072.
30. Samuels-Lev, Y., O'Connor, D.J., Bergamaschi, D., Trigiante, G., Hsieh, J.-K., Zhong, S., Campargue, I., Naumovski, L., Crook, T. and Lu, X. (2001) ASPP proteins specifically stimulate the apoptotic function of p53. *Mol. Cell*, **8**, 781–794.
31. Liu, Y.Z., Dawson, S.J. and Latchman, D.S. (1996) Alternative splicing of the Brn-3a and Brn-3b transcription factor mRNAs is regulated in neuronal cells. *J. Mol. Neurosci.*, **7**, 77–85.